

MSG series

Rugged switch guards for switch series 12000 - 3500 - 600H - 6000



DISTINCTIVE FEATURES

Robust

For harsh environments

Modern, patented design



GENERAL SPECIFICATIONS

- APEM SAS patented design
- Operating temperature : -40 °C to +85 °C (-40 °F to +185 °F)
- Storage temperature : -55 °C to +85 °C (-67 °F to +185 °F)
- Salt spray : IEC 60068-2-11, test KA, 96 hours
- Mechanical life : 20,000 cycles
- Switch guards are designed to prevent accidental lever operation on switches with \varnothing 11.9 (.468) or \varnothing 12 (.472) threaded bushing and lever length 17.5 (.688) outside bushing.
When the guard is raised, the lever can be operated freely.
When the guard is fully depressed, the lever is reset/locked in a stable position.
Note : For correct switch operation, the switch guard should be adjusted properly (see "Mounting" below).



MATERIALS

- Support plate : black stainless steel
- Cap : thermoset

APEM products may be recycled at end-of-life for the re-claiming of valuable metal components.



PANEL CUT-OUT

FOR BUSHING WITH KEYWAY

FOR FLATTED BUSHING

K

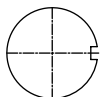

F

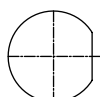

The company reserves the right to change specifications without notice.



MSG series

Rugged switch guards for switch series 12000 - 3500 - 600H - 6000

MOUNTING

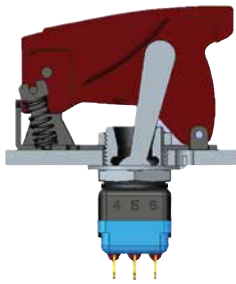

Standard

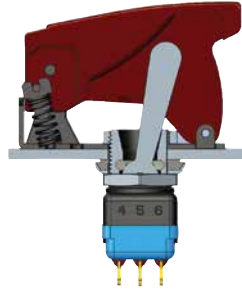

With K sealing option

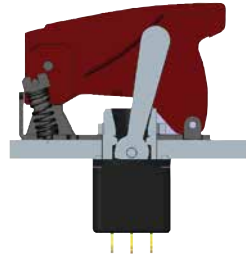

With X408 sealing option

BUILD YOUR PART NUMBER

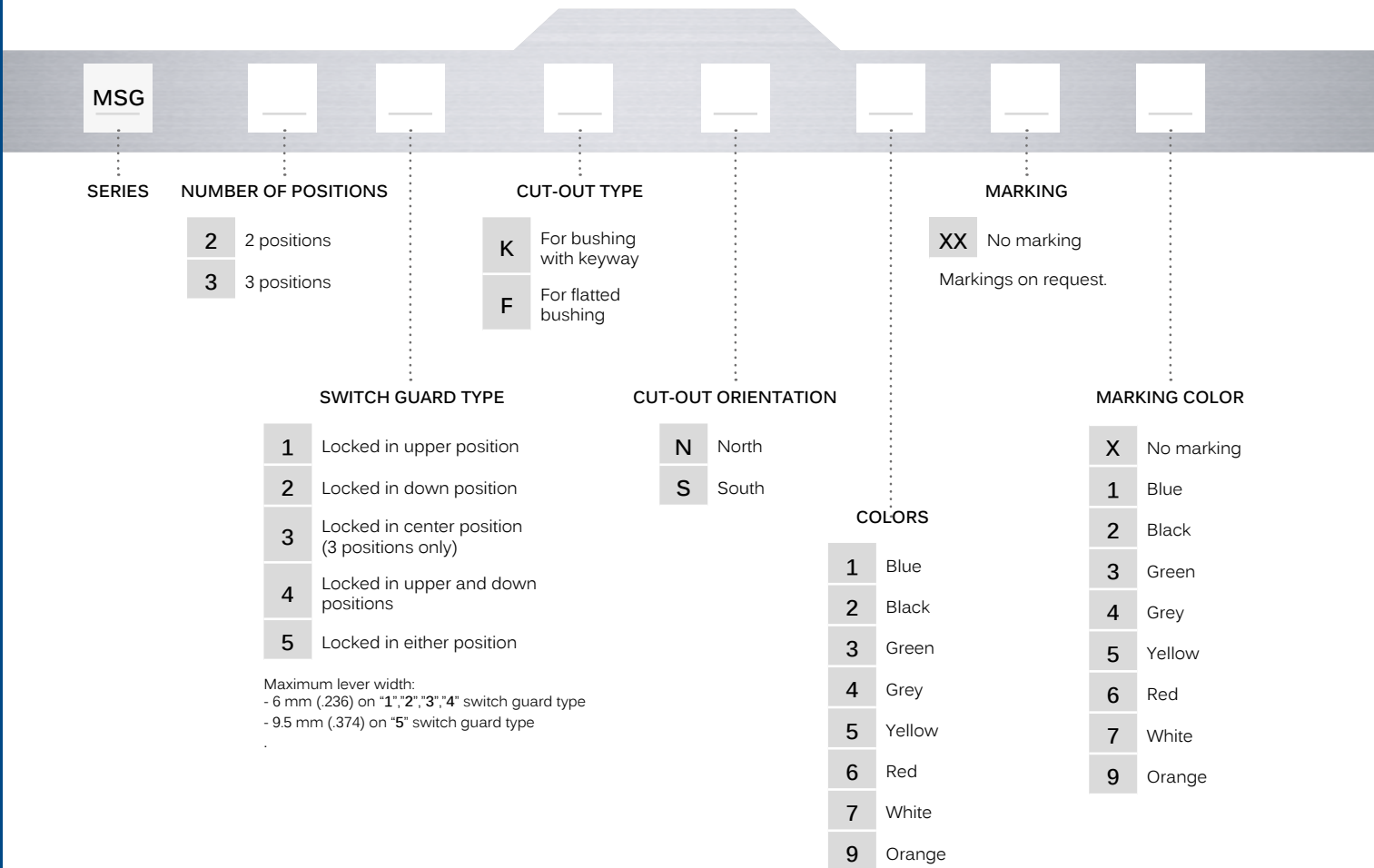

ABOUT THIS SERIES

On the following pages, you will find successively basic part numbers and options in the same order as in above chart.

- Notice** : please note that not all combinations of above numbers are available. Refer to the following pages for further information.
- Mounting accessories** : supplied with the switch or to order separately (see "Hardware" section of website).

MSG series

Rugged switch guards for switch series 12000 - 3500 - 600H - 6000

DIMENSIONS



Note : Ø 1.80 mm holes for wiring a seal are standard on all models.

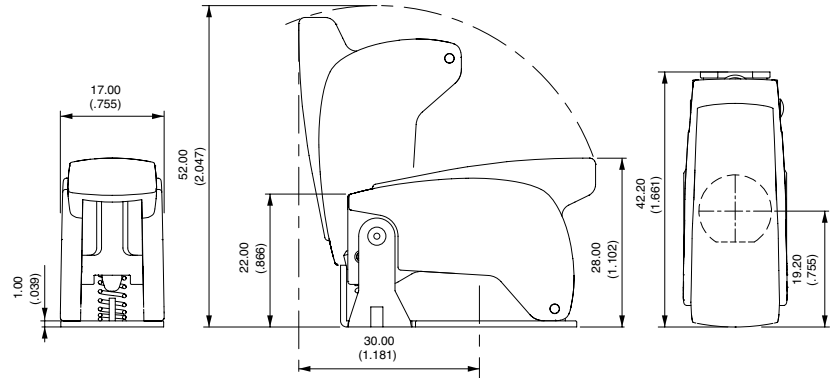

NUMBER OF POSITIONS

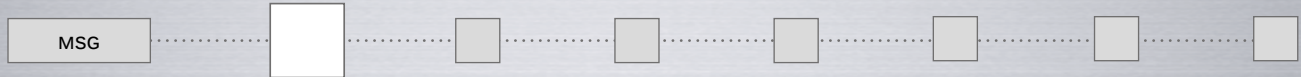

- 2 2 positions
- 3 3 positions

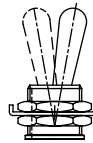

2



3

SWITCH GUARD TYPE



- 1 Locked in upper position
- 2 Locked in down position
- 3 Locked in center position (3 positions only)
- 4 Locked in upper and down positions
- 5 Locked in either position

Maximum lever width:

- 6 mm (.236) on "1","2","3","4" switch guard type
- 9.5 mm (.374) on "5" switch guard type



1

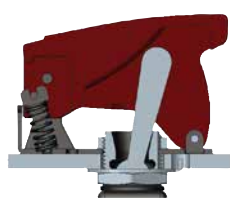

2

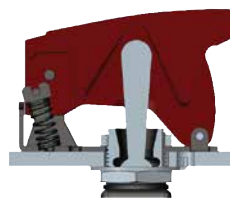

3

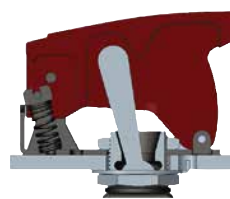

4

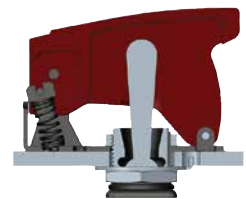

5

MSG series

Rugged switch guards for switch series 12000 - 3500 - 600H - 6000

CUT-OUT TYPE



- K For bushing with keyway
- F For flatted bushing



K



F

CUT-OUT ORIENTATION

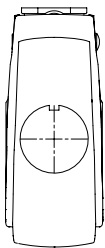

N

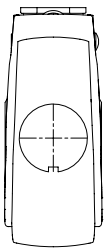

S

COLORS

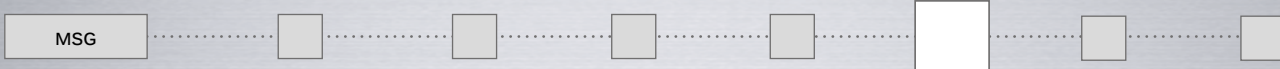

- 1 Blue
- 2 Black
- 3 Green
- 4 Grey
- 5 Yellow
- 6 Red
- 7 White
- 9 Orange



MARKING

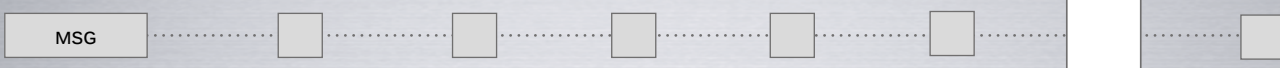

- XX No marking
- On request.

MARKING COLOR

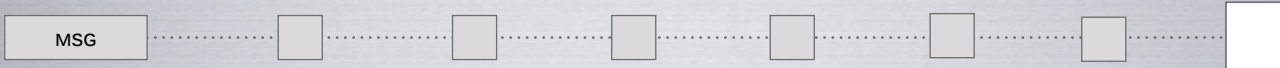

- | | | | | | |
|----|------------|---|--------|---|--------|
| XX | No marking | 3 | Green | 6 | Red |
| 1 | Blue | 4 | Grey | 7 | White |
| 2 | Black | 5 | Yellow | 9 | Orange |

Компания «Life Electronics» занимается поставками электронных компонентов импортного и отечественного производства от производителей и со складов крупных дистрибьюторов Европы, Америки и Азии.

С конца 2013 года компания активно расширяет линейку поставок компонентов по направлению коаксиальный кабель, кварцевые генераторы и конденсаторы (керамические, пленочные, электролитические), за счёт заключения дистрибьюторских договоров

Мы предлагаем:

- Конкурентоспособные цены и скидки постоянным клиентам.
- Специальные условия для постоянных клиентов.
- Подбор аналогов.
- Поставку компонентов в любых объемах, удовлетворяющих вашим потребностям.
- Приемлемые сроки поставки, возможна ускоренная поставка.
- Доставку товара в любую точку России и стран СНГ.
- Комплексную поставку.
- Работу по проектам и поставку образцов.
- Формирование склада под заказчика.
- Сертификаты соответствия на поставляемую продукцию (по желанию клиента).
- Тестирование поставляемой продукции.
- Поставку компонентов, требующих военную и космическую приемку.
- Входной контроль качества.
- Наличие сертификата ISO.

В составе нашей компании организован Конструкторский отдел, призванный помогать разработчикам, и инженерам.

Конструкторский отдел помогает осуществить:

- Регистрацию проекта у производителя компонентов.
- Техническую поддержку проекта.
- Защиту от снятия компонента с производства.
- Оценку стоимости проекта по компонентам.
- Изготовление тестовой платы монтаж и пусконаладочные работы.



Тел: +7 (812) 336 43 04 (многоканальный)

Email: org@lifeelectronics.ru