

THIS DRAWING IS UNPUBLISHED. RELEASED FOR PUBLICATION
 © COPYRIGHT BY TYCO ELECTRONICS CORPORATION. ALL RIGHTS RESERVED.

LOC		DIST		REVISIONS			
P	LTR	DATE	DWN	APVD			
AD	00						
	H	REVISED PER EC 0512-0273-05	19SEP05	JDP	DD		

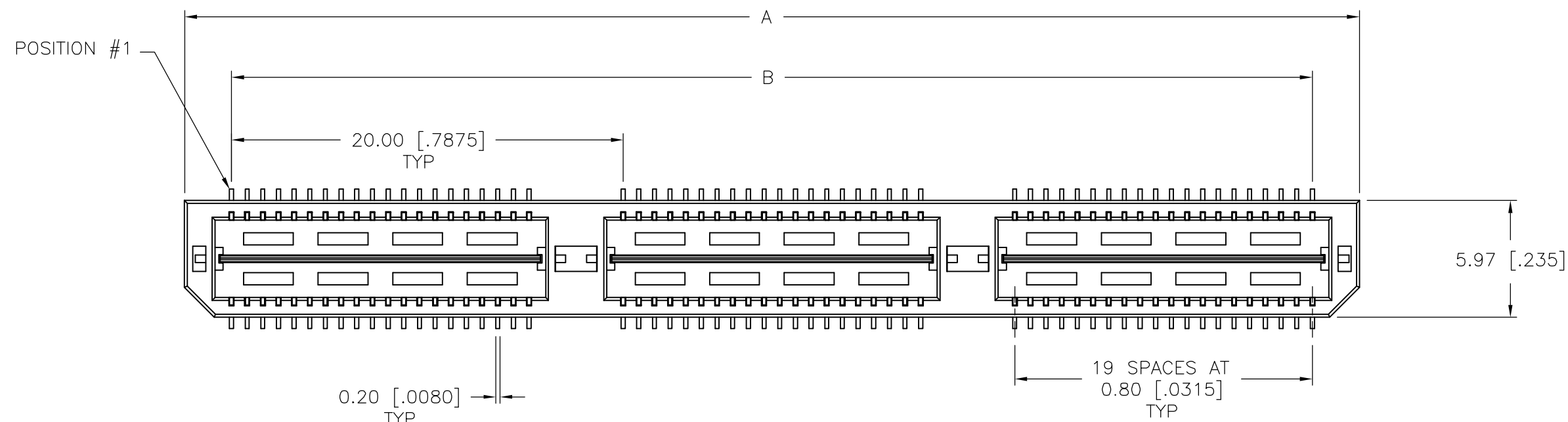

- 1 HOUSING: LCP, BLACK.
CONTACT & GROUND PLANE: PHOS BRONZE.
- 2 CONTACT PLATING: SELECT 0.25 MICROMETERS (.000010 IN.) MIN. GOLD.
- 3 FOR STANDARD APPLICATIONS, ORIENTATION HOLE TO BE $\phi 1.02 [\phi.0400]$.

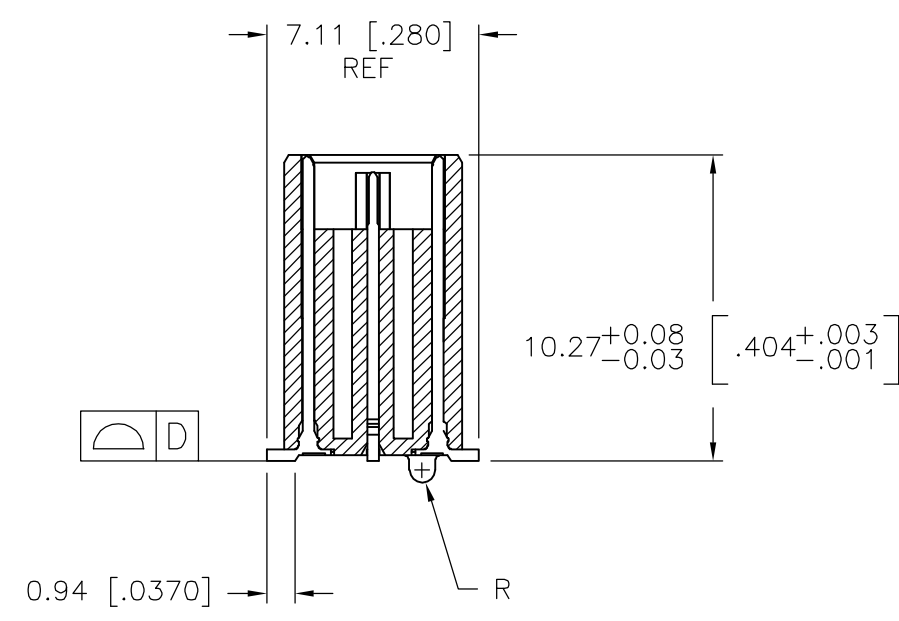
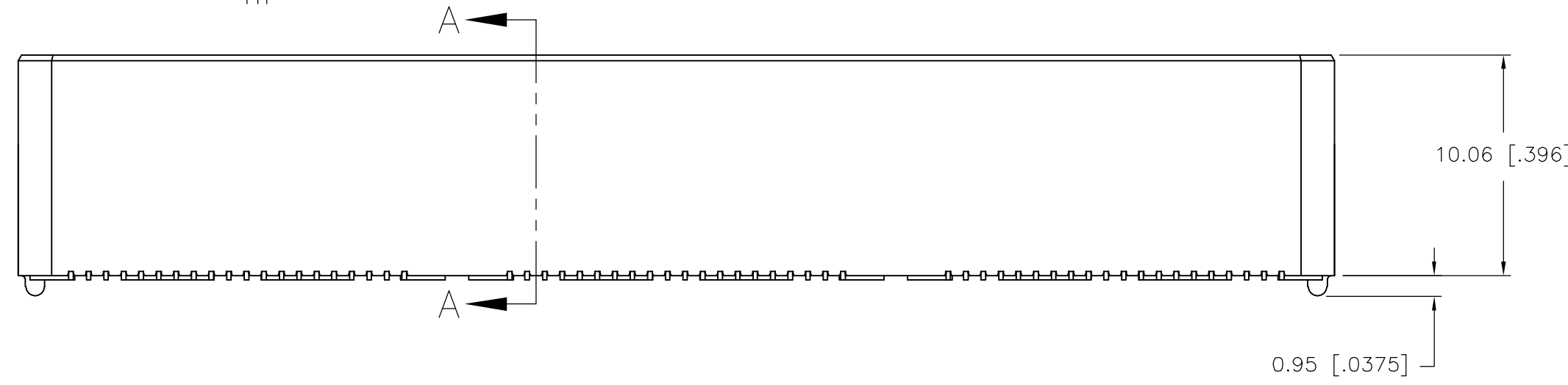

SECTION A-A

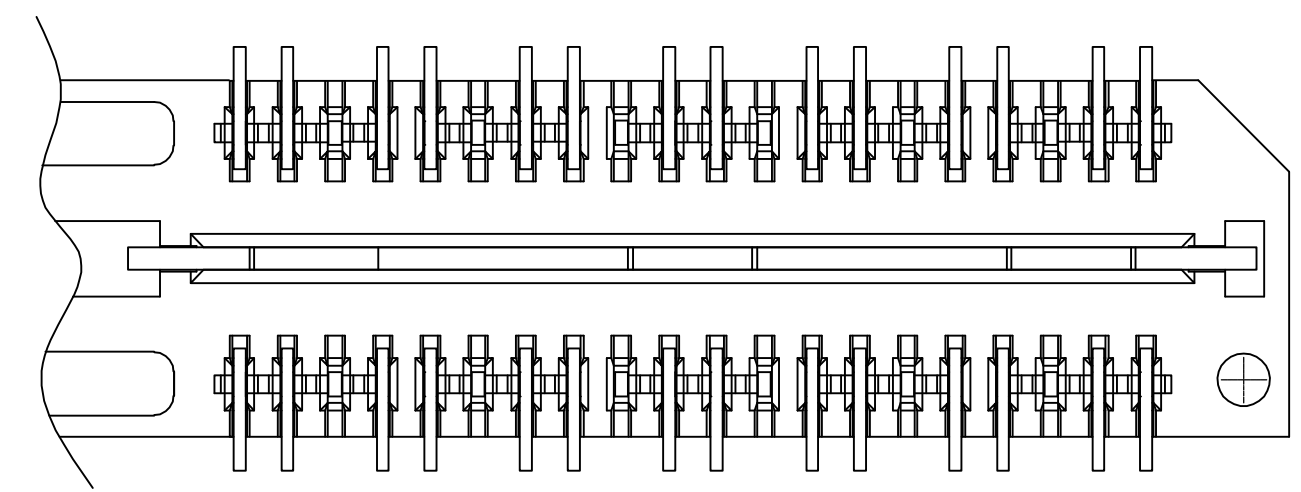
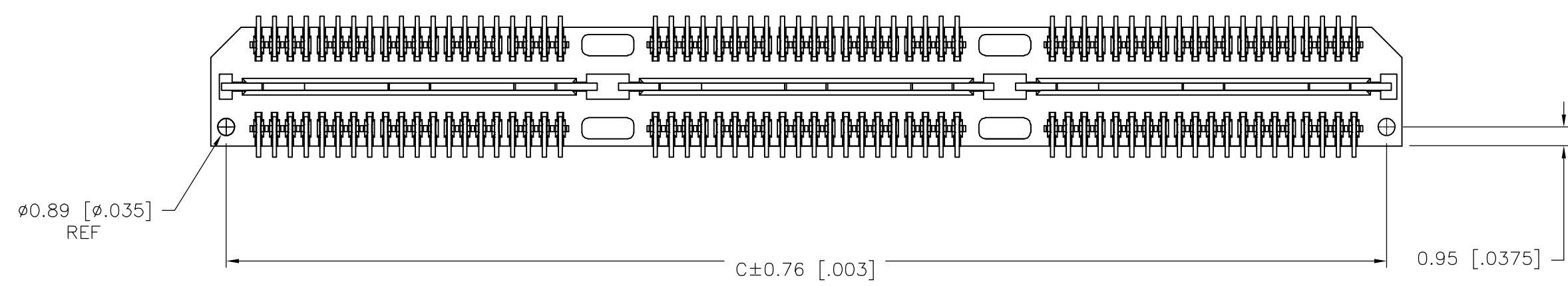

DIFFERENTIAL PAIR LOADING
(BOTTOM VIEW)
SCALE 2:1

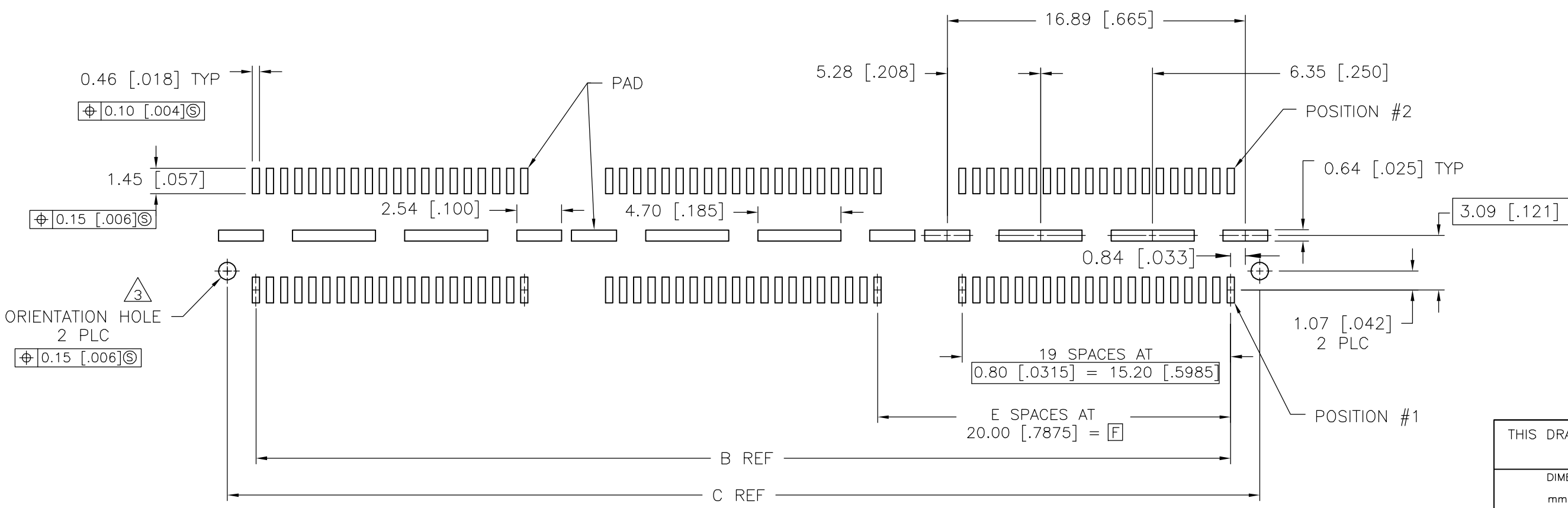

RECOMMENDED PC BOARD LAYOUT
(VIEWED FROM CONNECTOR SIDE)

THIS DRAWING IS A CONTROLLED DOCUMENT.		DWN B.CARRO 30JAN03	 Tyco Electronics Corporation Harrisburg, PA 17105-3608	RESTRICTED TO	
DIMENSIONS: mm [INCHES]		CHK D.DIXON 30JAN03		NAME	
TOLERANCES UNLESS OTHERWISE SPECIFIED:		APVD D.DIXON 30JAN03		PRODUCT SPEC	
0 PLC ± - 1 PLC ± 0.3[.01] 2 PLC ± 0.13[.005] 3 PLC ± 0.051[.0020] 4 PLC ± - ANGLES ± 2° FINISH		APPLICATION SPEC		HEATER ASSEMBLY, 11.0MM [.433] VERTICAL, 0.80MM CL, MICTOR SB	
MATERIAL	1	WEIGHT -	SIZE A2	CAGE CODE 00779	
		CUSTOMER DRAWING	DRAWING NO C=1658015	SCALE 3:1	
			SHEET 1 of 2	REV H	

THIS DRAWING IS UNPUBLISHED. RELEASED FOR PUBLICATION
 © COPYRIGHT BY TYCO ELECTRONICS CORPORATION. ALL RIGHTS RESERVED.

LOC	DIST	REVISIONS			
P	LTR	DESCRIPTION	DATE	DWN	APVD
AD	00	SEE SHEET 1	-	-	-

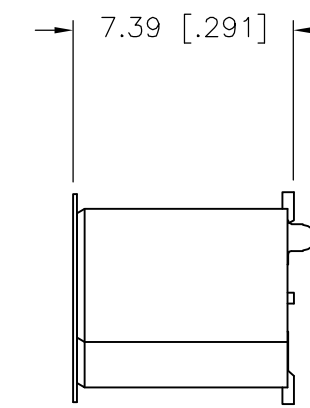
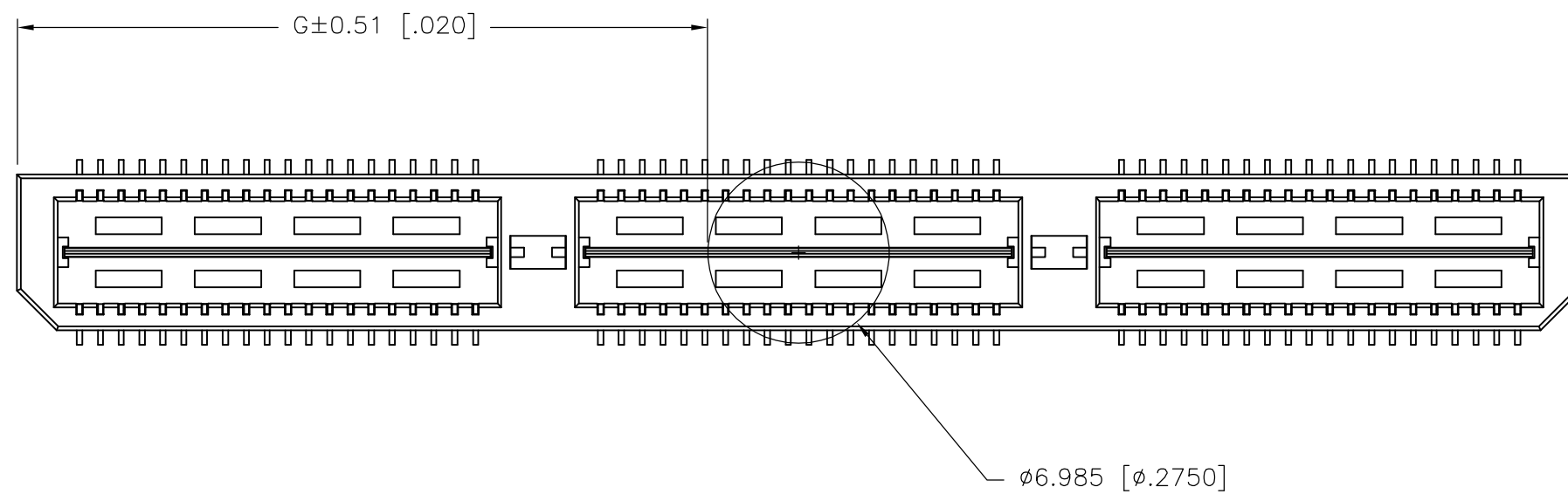

26.52(1.044)	40.00(1.575)	2	0.102(.0040)	58.50(2.303)	55.20(2.173)	60.00(2.362)	YES	POCKET TAPE	YES	84	7-1658015-3
16.51(.650)	20.00(.7874)	1	0.102(.0040)	38.48(1.515)	35.20(1.386)	40.00(1.575)	YES	POCKET TAPE	YES	56	7-1658015-2
6.50(.256)	0(.000)	0	0.102(.0040)	18.49(.728)	15.20(.598)	20.00(.787)	YES	POCKET TAPE	YES	28	7-1658015-1
26.52(1.044)	40.00(1.575)	2	0.102(.0040)	58.50(2.303)	55.20(2.173)	60.00(2.362)	YES	POCKET TAPE	NO	120	6-1658015-3
16.51(.650)	20.00(.7874)	1	0.102(.0040)	38.48(1.515)	35.20(1.386)	40.00(1.575)	YES	POCKET TAPE	NO	80	6-1658015-2
6.50(.256)	0(.000)	0	0.102(.0040)	18.49(.728)	15.20(.598)	20.00(.787)	YES	POCKET TAPE	NO	40	6-1658015-1
-	40.00(1.575)	2	0.102(.0040)	58.50(2.303)	55.20(2.173)	60.00(2.362)	NO	POCKET TAPE	YES	84	5-1658015-3
-	20.00(.7874)	1	0.102(.0040)	38.48(1.515)	35.20(1.386)	40.00(1.575)	NO	POCKET TAPE	YES	56	5-1658015-2
-	0(.000)	0	0.102(.0040)	18.49(.728)	15.20(.598)	20.00(.787)	NO	POCKET TAPE	YES	28	5-1658015-1
-	40.00(1.575)	2	0.102(.0040)	58.50(2.303)	55.20(2.173)	60.00(2.362)	NO	POCKET TAPE	NO	120	4-1658015-3
-	20.00(.7874)	1	0.102(.0040)	38.48(1.515)	35.20(1.386)	40.00(1.575)	NO	POCKET TAPE	NO	80	4-1658015-2
-	0(.000)	0	0.102(.0040)	18.49(.728)	15.20(.598)	20.00(.787)	NO	POCKET TAPE	NO	40	4-1658015-1
46.51(1.831)	80.00(3.150)	4	0.152(.0060)	98.50(3.748)	95.20(3.748)	100.00(3.937)	YES	TRAY	YES	140	3-1658015-5
36.53(1.438)	60.00(2.362)	3	0.152(.0060)	78.49(3.090)	75.20(2.961)	80.00(3.150)	YES	TRAY	YES	112	3-1658015-4
26.52(1.044)	40.00(1.575)	2	0.102(.0040)	58.50(2.303)	55.20(2.173)	60.00(2.362)	YES	TRAY	YES	84	3-1658015-3
16.51(.650)	20.00(.7874)	1	0.102(.0040)	38.48(1.515)	35.20(1.386)	40.00(1.575)	YES	TRAY	YES	56	3-1658015-2
6.50(.256)	0(.000)	0	0.102(.0040)	18.49(.728)	15.20(.598)	20.00(.787)	YES	TRAY	YES	28	3-1658015-1
46.51(1.831)	80.00(3.150)	4	0.152(.0060)	98.50(3.748)	95.20(3.748)	100.00(3.937)	YES	TRAY	NO	200	2-1658015-5
36.53(1.438)	60.00(2.362)	3	0.152(.0060)	78.49(3.090)	75.20(2.961)	80.00(3.150)	YES	TRAY	NO	160	2-1658015-4
26.52(1.044)	40.00(1.575)	2	0.102(.0040)	58.50(2.303)	55.20(2.173)	60.00(2.362)	YES	TRAY	NO	120	2-1658015-3
16.51(.650)	20.00(.7874)	1	0.102(.0040)	38.48(1.515)	35.20(1.386)	40.00(1.575)	YES	TRAY	NO	80	2-1658015-2
6.50(.256)	0(.000)	0	0.102(.0040)	18.49(.728)	15.20(.598)	20.00(.787)	YES	TRAY	NO	40	2-1658015-1
-	80.00(3.150)	4	0.152(.0060)	98.50(3.748)	95.20(3.748)	100.00(3.937)	NO	TRAY	YES	140	1-1658015-5
-	60.00(2.362)	3	0.152(.0060)	78.49(3.090)	75.20(2.961)	80.00(3.150)	NO	TRAY	YES	112	1-1658015-4
-	40.00(1.575)	2	0.102(.0040)	58.50(2.303)	55.20(2.173)	60.00(2.362)	NO	TRAY	YES	84	1-1658015-3
-	20.00(.7874)	1	0.102(.0040)	38.48(1.515)	35.20(1.386)	40.00(1.575)	NO	TRAY	YES	56	1-1658015-2
-	0(.000)	0	0.102(.0040)	18.49(.728)	15.20(.598)	20.00(.787)	NO	TRAY	YES	28	1-1658015-1
-	80.00(3.150)	4	0.152(.0060)	98.50(3.748)	95.20(3.748)	100.00(3.937)	NO	TRAY	NO	200	1658015-5
-	60.00(2.362)	3	0.152(.0060)	78.49(3.090)	75.20(2.961)	80.00(3.150)	NO	TRAY	NO	160	1658015-4
-	40.00(1.575)	2	0.102(.0040)	58.50(2.303)	55.20(2.173)	60.00(2.362)	NO	TRAY	NO	120	1658015-3
-	20.00(.7874)	1	0.102(.0040)	38.48(1.515)	35.20(1.386)	40.00(1.575)	NO	TRAY	NO	80	1658015-2
-	0(.000)	0	0.102(.0040)	18.49(.728)	15.20(.598)	20.00(.787)	NO	TRAY	NO	40	1658015-1
G	F	E	D	C	B	A	POLYIMIDE FILM PAD ▲	PACKAGING TYPE	DIFF. PAIR	NO OF POS	PART NUMBER

THIS DRAWING IS A CONTROLLED DOCUMENT.

DWN B.CARRO 30JAN03
 CHK D.DIXON 30JAN03
 APVD D.DIXON 30JAN03

TOLERANCES UNLESS OTHERWISE SPECIFIED:
 0 PLC ± -
 1 PLC ± 0.3[.01]
 2 PLC ± 0.13[.005]
 3 PLC ± 0.05[.0020]
 4 PLC ± -
 ANGLES ± 2°

MATERIAL SEE SHEET 1
 FINISH SEE SHEET 1

WEIGHT -
 CUSTOMER DRAWING

tyco Electronics Tyco Electronics Corporation
 Harrisburg, PA 17105-3608

NAME: HEADER ASSEMBLY, 11.0MM [.433] VERTICAL,
 0.80MM CL,
 MICTOR SB

SIZE: A2 CAGE CODE: 00779 DRAWING NO: C=1658015 RESTRICTED TO: -
 SCALE: 3:1 SHEET: 2 of 2 REV: H

Компания «Life Electronics» занимается поставками электронных компонентов импортного и отечественного производства от производителей и со складов крупных дистрибьюторов Европы, Америки и Азии.

С конца 2013 года компания активно расширяет линейку поставок компонентов по направлению коаксиальный кабель, кварцевые генераторы и конденсаторы (керамические, пленочные, электролитические), за счёт заключения дистрибьюторских договоров

Мы предлагаем:

- Конкурентоспособные цены и скидки постоянным клиентам.
- Специальные условия для постоянных клиентов.
- Подбор аналогов.
- Поставку компонентов в любых объемах, удовлетворяющих вашим потребностям.
- Приемлемые сроки поставки, возможна ускоренная поставка.
- Доставку товара в любую точку России и стран СНГ.
- Комплексную поставку.
- Работу по проектам и поставку образцов.
- Формирование склада под заказчика.
- Сертификаты соответствия на поставляемую продукцию (по желанию клиента).
- Тестирование поставляемой продукции.
- Поставку компонентов, требующих военную и космическую приемку.
- Входной контроль качества.
- Наличие сертификата ISO.

В составе нашей компании организован Конструкторский отдел, призванный помогать разработчикам, и инженерам.

Конструкторский отдел помогает осуществить:

- Регистрацию проекта у производителя компонентов.
- Техническую поддержку проекта.
- Защиту от снятия компонента с производства.
- Оценку стоимости проекта по компонентам.
- Изготовление тестовой платы монтаж и пусконаладочные работы.



Тел: +7 (812) 336 43 04 (многоканальный)

Email: org@lifeelectronics.ru