

## MAGNETIC-LATCHING DC-8 GHz TO-5 RELAYS 4PST

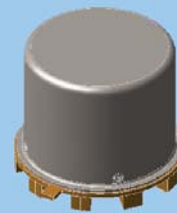

SERIES	RELAY TYPE
GRF424	4PST RF Relay
GRF424D	4PST RF Relay with internal diodes for coil transient suppression

### DESCRIPTION

The GRF424 series relay is an ultraminiature, hermetically sealed, magnetic-latching relay featuring low intercontact capacitance for exceptional RF performance from DC-8 GHz. It's low profile and small size make it ideal for applications where extreme packaging density and/or close PC board spacing are required. Due to its minimal mass, many relays may be used to configure replacements for bulkier switching solutions at a substantial savings in weight. These design features make these unique relays the perfect choice for use in RF attenuators, RF switching matrices and other RF applications requiring low insertion loss and low VSWR. The basic operating mechanism is similar to the TO-5 422 series relay.

The following unique construction features and manufacturing techniques provide overall high reliability and excellent resistance to environmental extremes:

- Minimum mass components and welded construction provide maximum resistance to shock and vibration.
- Advanced cleaning techniques provide maximum assurance of internal cleanliness.
- Gold-plated precious metal contacts ensure reliable, lowlevel switching.

The RF424 relay is ideally suited for applications where power dissipation must be minimized. The relays can be operated with a short duration pulse. After the contacts have transferred, no external holding power is required. The magnetic latching feature of the RF424 series provides a nonvolatile "memory" capability since the relays will not reset upon removal of coil power. The 424D series utilizes discrete diodes for coil suppression.

### PRINCIPAL OF OPERATION

Energizing Coil B produces a magnetic field opposing the holding flux of the permanent magnet in Circuit B. As this net holding force decreases, the attractive force in the air gap of Circuit A, which also results from the flux of the permanent magnet, becomes great enough to break the armature free of Core B, and snap it into a closed position against Core A. The armature then remains in this position upon removal of power from Coil B, but will snap back into position B upon energizing Coil A. Since operation depends upon cancellation of a magnetic field, it is necessary to apply the correct polarity to the relay coils as indicated on the relay schematic. When latching relays are installed in equipment, the latch and reset coils should not be pulsed simultaneously. Coils should not be pulsed with less than rated coil voltage and the pulse width should be a minimum of three times the specified operate time of the relay. If these conditions are not followed, it is possible for the relay to be in the magnetic neutral position.

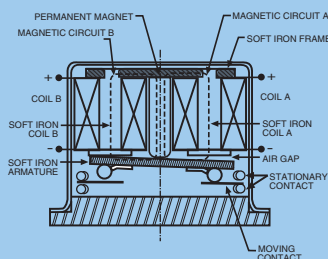

### ENVIRONMENTAL AND PHYSICAL SPECIFICATIONS

<b>Temperature</b>	
Storage	-65°C to +125°C
Operating	-55°C to +85°C
<b>Vibration</b> (General Note 1)	10 g's to 500 Hz
<b>Shock</b> (General Note 1)	30 g's, for 6 msec half sine
<b>Enclosure</b>	Hermetically Sealed
<b>Weight</b>	0.1 oz. (2.9g) max.

**SERIES GRF424/GRF424D**  
**TYPICAL RF CHARACTERISTICS (See RF Notes)**

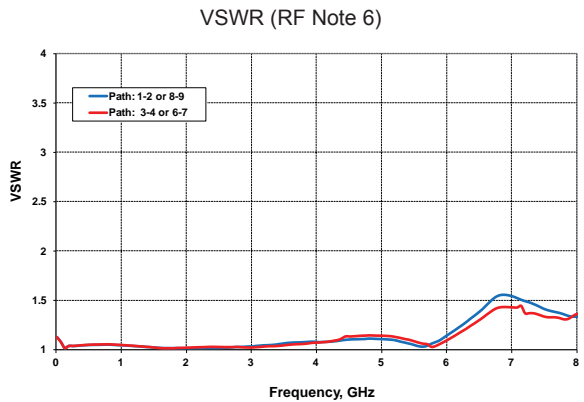
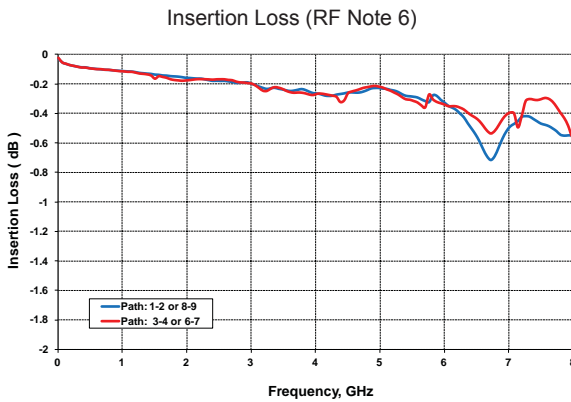
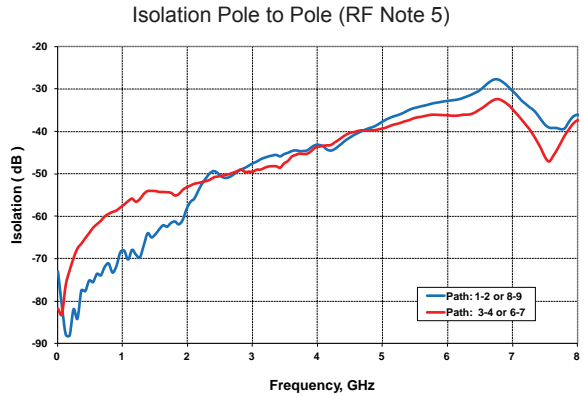
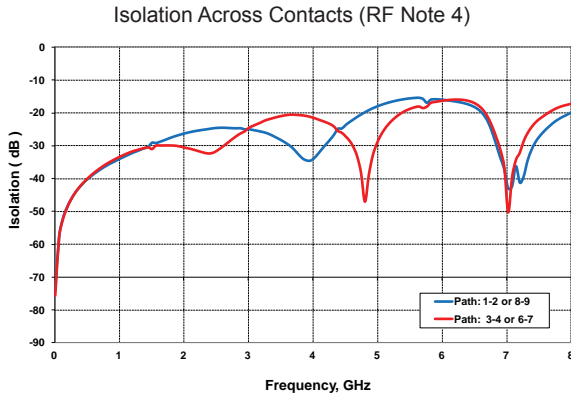

**RF NOTES**

1. Test conditions:
  - a. Fixture: .031" copper clad, reinforced PTFE, RT/duroid® 6002 with SMA connectors. (RT/duroid® is a registered trademark of Rogers Corporation.)
  - b. Relay header is soldered to ground plane.
  - c. Room ambient temperature.
  - d. All terminals not tested were terminated with 50-ohm load.
  - e. Contact signal level: -10 dBm.
  - f. No. of test samples: 2.
2. Data presented herein represents typical characteristics and is not intended for use as specification limits.
3. Data is per pole, except for pole-to-pole data.
4. Data is the average from readings taken on poles after Coil A is energized then Coil B is energized.
5. Data is the average from readings taken on all closed contacts.
6. Test fixture effect de-embedded from frequency and time response data.

**SERIES GRF424A/GRF424D**  
**GENERAL ELECTRICAL SPECIFICATIONS (@25°C unless otherwise noted) (Note 2)**

<b>Contact Arrangement</b>	Bi-Stable (4PST)
<b>Rated Duty</b>	Continuous
<b>Contact Resistance</b>	0.15 Ω max. initial (measured 1/8" from the header)
<b>Contact Load Rating</b>	Resistive: 1Amp/28Vdc Low level: 10 to 50 μA @ 10 to 50 mV
<b>Contact Life Ratings</b>	10,000,000 cycles (typical) at low level 100,000 cycles min. at all other loads specified above
<b>Coil Operating Power</b>	RF424-5: 410 mW typical @ nominal rated voltage RF424-12: 288 mW typical @ nominal rated voltage RF424-26: 351 mW typical @ nominal rated voltage
<b>Operate Time</b>	1.5 mS max. @ nominal rated voltage
<b>Contact Bounce</b>	3.0 mS max.
<b>Intercontact Capacitance</b>	0.4 pf typical
<b>Insulation Resistance</b>	10,000 MΩ min. between mutually isolated terminals
<b>Dielectric Strength</b>	350 Vrms (60 Hz) @ atmospheric pressure 125 Vrms (60 Hz) @ 70,000 ft
<b>Negative Coil Transient (Vdc)</b>	RF424D: 1.0 max.
<b>Diode P.I.V. (Vdc)</b>	RF424D: 100 min.

**DETAILED ELECTRICAL SPECIFICATIONS (@25°C)**

BASE PART NUMBERS		GRF424-5 GRF424D-5	GRF424-12 GRF424D-12	GRF424-26 GRF424D-26
<b>Coil Voltage, Nominal (Vdc)</b>	Nom.	5.0	12.0	26.5
	Max.	6.5	16.0	32.0
<b>Coil Resistance (Ohms ±20% @ 25°C) (Note 4)</b>		61	500	2000
<b>Set &amp; Reset Voltage (Vdc, Max.) Pulse Operated</b>		4.0	9.6	19.0

Teledyne Part Numbering System for GRF424

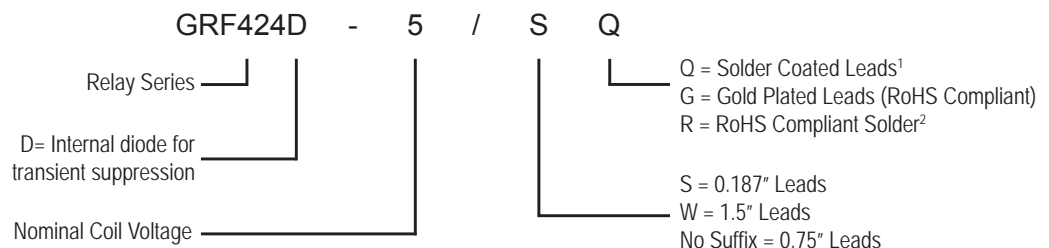

**General Note:** Parts ordered without suffix may be supplied with Solder-Coated or Gold-Plated leads

<sup>1</sup> Parts ordered with Solder-Coated leads will have (Sn60/Pb40)

<sup>2</sup> Parts ordered with RoHS Solder-Coated leads will have (Sn99.3/Cu0.7)

**SERIES GRF424/RF424D  
OUTLINE DIMENSIONS**

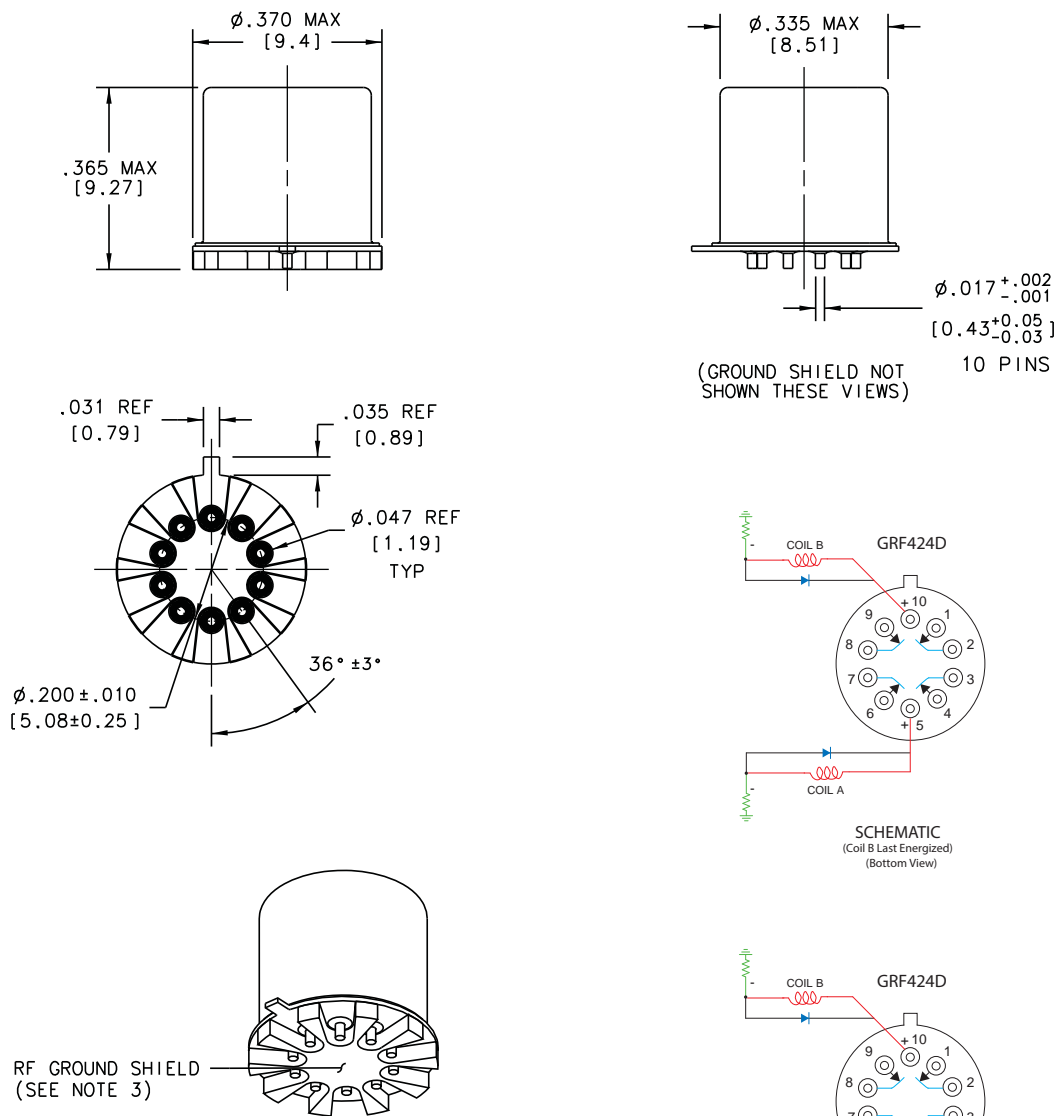

**NOTES:**  
1. DIMENSIONS ARE IN INCHES, METRIC EQUIVALENTS SHOWN IN [ ].

**GENERAL NOTES**

1. Relays will exhibit no contact chatter in excess of 10  $\mu\text{sec}$  or transfer in excess of 1  $\mu\text{sec}$ .
2. Unless otherwise specified, parameters are initial values.
3. For extended contact life ratings, contact factory.
4. Contacts shown in position resulting when Coil B last energized.

**SERIES GRF424/GRF424D**  
**TYPICAL SIGNAL INTEGRITY CHARACTERISTICS**

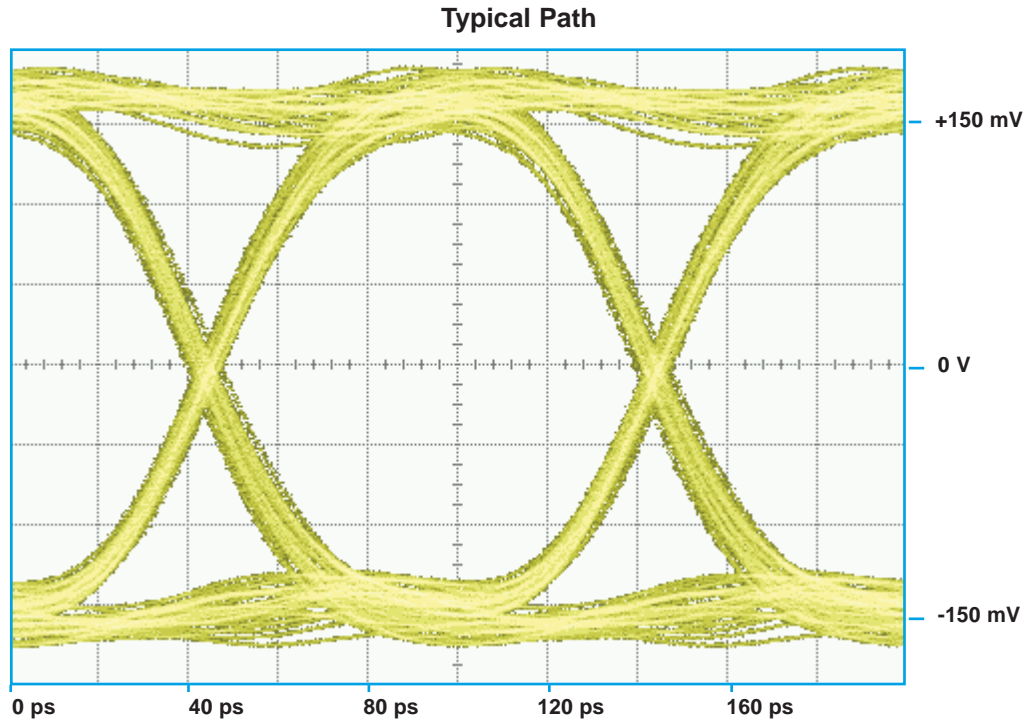

Eye Height	Eye Width	SNR	Jitter <sub>P-P</sub>
254.0 mV	90.27 ps	15.61	8.89 ps

**PATTERN GENERATOR SETTINGS**

- 10 Gbps Random Pulse Pattern Generator
- $2^{31} - 1$  PRBS signal
- PRBS output of 300 mV<sub>P-P</sub> (nominal)
- RF PCB effect (negligible) not removed from measurement
- Data shown is typical of both poles

Компания «Life Electronics» занимается поставками электронных компонентов импортного и отечественного производства от производителей и со складов крупных дистрибьюторов Европы, Америки и Азии.

С конца 2013 года компания активно расширяет линейку поставок компонентов по направлению коаксиальный кабель, кварцевые генераторы и конденсаторы (керамические, пленочные, электролитические), за счёт заключения дистрибьюторских договоров

Мы предлагаем:

- Конкурентоспособные цены и скидки постоянным клиентам.
- Специальные условия для постоянных клиентов.
- Подбор аналогов.
- Поставку компонентов в любых объемах, удовлетворяющих вашим потребностям.
- Приемлемые сроки поставки, возможна ускоренная поставка.
- Доставку товара в любую точку России и стран СНГ.
- Комплексную поставку.
- Работу по проектам и поставку образцов.
- Формирование склада под заказчика.
- Сертификаты соответствия на поставляемую продукцию (по желанию клиента).
- Тестирование поставляемой продукции.
- Поставку компонентов, требующих военную и космическую приемку.
- Входной контроль качества.
- Наличие сертификата ISO.

В составе нашей компании организован Конструкторский отдел, призванный помогать разработчикам, и инженерам.

Конструкторский отдел помогает осуществить:

- Регистрацию проекта у производителя компонентов.
- Техническую поддержку проекта.
- Защиту от снятия компонента с производства.
- Оценку стоимости проекта по компонентам.
- Изготовление тестовой платы монтаж и пусконаладочные работы.



Тел: +7 (812) 336 43 04 (многоканальный)

Email: [org@lifeelectronics.ru](mailto:org@lifeelectronics.ru)