

### AD7506/AD7507

#### FEATURES

- R<sub>ON</sub>: 300Ω**
- Power Dissipation: 1.5mW**
- TTL/DTL/CMOS Direct Interface**
- Break-Before-Make Switching**
- Standard 28-Pin DIPs and 28-Terminal Surface Mount Packages**

#### GENERAL DESCRIPTION

The AD7506 is a monolithic CMOS 16-channel analog multiplexer packaged in a 28-pin DIP or a 28-terminal surface mount package. It switches a common output to one of 16 inputs, depending on the state of four address lines and an "enable." The AD7507 is identical to the AD7506 except it has two outputs switched to two of 16 inputs depending on three binary address states and an "enable."

#### ABSOLUTE MAXIMUM RATINGS\*

- (T<sub>A</sub> = +25°C unless otherwise noted)
- V<sub>DD</sub> - GND . . . . . +17V
  - V<sub>SS</sub> - GND . . . . . -17V
  - V Between Any Switch Terminals (see Note 1) . . . . . 25V
  - Digital Input Voltage Range . . . . . V<sub>DD</sub> to GND
  - Overvoltage at V<sub>OUT</sub> (V<sub>S</sub>) . . . . . V<sub>SS</sub>, V<sub>DD</sub>
  - Overcurrent (I<sub>S</sub>, Continuous One Channel) . . . . . 20mA
  - Switch Current (I<sub>S</sub>, Surge One Channel) . . . . . 35mA
  - 1ms Duration, 10% Duty Cycle . . . . . 35mA
  - Power Dissipation (Any Package)
  - Up to +50°C . . . . . 1000mW
  - Derates above +50°C by . . . . . 10mW/°C
  - Operating Temperature
  - Commercial (KN Versions) . . . . . 0 to +70°C
  - Industrial (KQ Versions) . . . . . -25°C to +85°C
  - Extended (TQ, TE Versions) . . . . . -55°C to +125°C
  - Storage Temperature . . . . . -65°C to +150°C
  - Lead Temperature (Soldering, 10sec) . . . . . +300°C

#### CAUTION:

- <sup>1</sup>Do not apply voltage higher than V<sub>DD</sub> and V<sub>SS</sub> to any other terminal, especially when V<sub>SS</sub> = V<sub>DD</sub> = 0V all other pins should be at 0V.
- <sup>2</sup>The digital control inputs are diode protected; however, permanent damage may occur on unconnected units under high energy electrostatic fields. Keep unused units in conductive foam at all times.
- \*Stresses above those listed under "Absolute Maximum Ratings" may cause permanent damage to the device. This is a stress rating only and functional operation of the device at these or any other conditions above those indicated in the operational sections of this specification is not implied. Exposure to absolute maximum rating conditions for extended periods may affect device reliability. Only one Absolute Maximum Rating may be applied at any one time.

#### REV. A

Information furnished by Analog Devices is believed to be accurate and reliable. However, no responsibility is assumed by Analog Devices for its use, nor for any infringements of patents or other rights of third parties which may result from its use. No license is granted by implication or otherwise under any patent or patent rights of Analog Devices.

#### FUNCTIONAL DIAGRAMS



AD7506

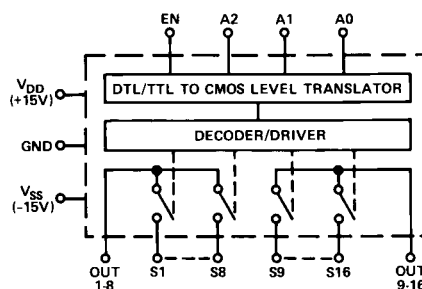

AD7507

#### ORDERING GUIDE

| Model <sup>1</sup> | Temperature Range | Package Option <sup>2</sup> |
|--------------------|-------------------|-----------------------------|
| AD7506KN           | 0°C to +70°C      | N-28                        |
| AD7506KQ           | -25°C to +85°C    | Q-28                        |
| AD7506TQ           | -55°C to +125°C   | Q-28                        |
| AD7506TE           | -55°C to +125°C   | E-28A                       |
| AD7507KN           | 0°C to +70°C      | N-28                        |
| AD7507KQ           | -25°C to +85°C    | Q-28                        |
| AD7507TQ           | -55°C to +125°C   | Q-28                        |
| AD7507TE           | -55°C to +125°C   | E-28A                       |

#### NOTES

- <sup>1</sup>To order MIL-STD-883, Class B, processed parts, add/883B to part number. See Analog Devices Military Products Databook (1990) for military data sheet.
- <sup>2</sup>N = Plastic DIP; Q = Cerdip; E = Leadless Ceramic Chip Carrier (LCCC).

**One Technology Way, P.O. Box 9106, Norwood, MA 02062-9106, U.S.A.**  
**Tel: 617/329-4700      Fax: 617/326-8703      Twx: 710/394-6577**  
**Telex: 924491      Cable: ANALOG NORWOODMASS**

# AD7506/AD7507 — SPECIFICATIONS ( $V_{DD} = +15V$ , $V_{SS} = -15V$ unless otherwise noted.)

| Parameter                                  | Version <sup>1</sup> | Switch Condition | @ +25°C                                    | Over Specified Temperature Range           | Test Conditions   |   |
|--|----------------------|------------------|--|--|---|---|
| <b>ANALOG SWITCH</b>                       |                      |                  |  |  |   |   |
| $R_{ON}$                                   | K<br>T               | ON<br>ON         | 300Ω typ, 450Ω max<br>400Ω max             | 550Ω max<br>500Ω max                       | $V_S = -10V$ to +10V, $I_S = 1mA$   |   |
| $R_{ON}$ vs. $V_S$                         | All                  | ON               | 15% typ                                    |  | $V_S = 0V$ , $I_S = 1mA$  |   |
| $R_{ON}$ vs. Temperature                   | All                  | ON               | 0.5%/°C typ                                |  |   |   |
| $\Delta R_{ON}$ Between Switches           | All                  | ON               | 4% typ                                     |  |   |   |
| $R_{ON}$ vs. Temperature Between Switches  | All                  | ON               | 0.05%/°C typ                               |  |   |   |
| $I_S$ (OFF)                                | K<br>T               | OFF<br>OFF       | 0.05nA typ, 5nA max<br>0.05nA typ, 1nA max | 50nA max<br>50nA max                       | $V_S = -10V$ , $V_{OUT} = +10V$<br>and  |   |
| $I_{OUT}$ (OFF)                            | AD7506               | K<br>T           | OFF<br>OFF                                 | 0.3nA typ, 20nA max<br>0.3nA typ, 10nA max | 500nA max<br>500nA max  | $V_S = +10V$ , $V_{OUT} = -10V$<br>“Enable” Low |
|  |                      | K<br>T           | OFF<br>OFF                                 | 0.3nA typ, 10nA max<br>0.3nA typ, 5nA max  | 250nA max<br>250nA max  |   |
| $I_{OUT} - I_S$<br>(Any Switch ON)         | AD7506               | K<br>T           | ON<br>ON                                   | 0.3nA typ, 20nA max<br>0.3nA typ, 10nA max | 500nA max<br>500nA max  | $V_S = 0V$                                      |
|  |                      | K<br>T           | ON<br>ON                                   | 0.3nA typ, 10nA max<br>0.3nA typ, 5nA max  | 250nA max<br>250nA max  |   |
| AD7507                                     | AD7507               | K<br>T           | ON<br>ON                                   | 0.3nA typ, 10nA max<br>0.3nA typ, 5nA max  | 250nA max<br>250nA max  |   |
|  |                      | K<br>T           | ON<br>ON                                   | 0.3nA typ, 10nA max<br>0.3nA typ, 5nA max  | 250nA max<br>250nA max  |   |
| <b>DIGITAL CONTROL</b>                     |                      |                  |  |  |   |   |
| $V_{INL}$                                  | All                  |                  |  | 0.8V max                                   |   |   |
| $V_{INH}$                                  | All                  |                  |  | 2.4V min                                   |   |   |
| $I_{INL}$ or $I_{INH}$                     | All                  |                  | 10μA max                                   | 30μA max                                   |   |   |
| $C_{IN}$                                   | All                  |                  | 3pF typ                                    |  |   |   |
| <b>DYNAMIC CHARACTERISTICS<sup>2</sup></b> |                      |                  |  |  |   |   |
| $t_{TRANSITION}$                           | All                  |                  | 700ns typ, 1000ns max                      |  | $V_{IN}$ : 0 to 3.0V  |   |
| $t_{OPEN}$                                 | All                  |                  | 100ns typ                                  |  |   |   |
| $t_{ON}$ (En)                              | All                  |                  | 1.5μs max                                  |  | $V_{EN}$ : 0 to 3.0V  |   |
| $t_{OFF}$ (En)                             | All                  |                  | 1μs max                                    |  |   |   |
| “OFF” Isolation                            | All                  |                  | 70dB typ                                   |  | $V_{EN} = 0$ , $R_L = 200\Omega$ , $C_L = 3.0pF$ ,<br>$V_S = 3.0V$ rms, $f = 50kHz$ |   |
| $C_S$                                      | All                  | OFF              | 5pF typ                                    |  |   |   |
| $C_{OUT}$                                  | AD7506               | All              | OFF  | 40pF typ                                   |   |   |
|  | AD7507               | All              | OFF  | 20pF typ                                   |   |   |
| $C_{S-OUT}$                                | All                  | OFF              | 0.5pF typ                                  |  |   |   |
| $C_{SS}$ Between Any Two Switches          | All                  | OFF              | 0.5pF typ                                  |  |   |   |
| <b>POWER SUPPLY</b>                        |                      |                  |  |  |   |   |
| $I_{DD}$                                   | K<br>T               | OFF<br>OFF       | 0.05mA typ, 1mA max<br>0.05mA typ, 1mA max | 2mA max                                    | All Digital Inputs Low  |   |
|  |                      | OFF<br>OFF       | 0.05mA typ, 1mA max<br>0.05mA typ, 1mA max |  |   |   |
| $I_{SS}$                                   | K<br>T               | OFF<br>OFF       | 0.05mA typ, 1mA max<br>0.05mA typ, 1mA max | 2mA max                                    | All Digital Inputs High   |   |
|  |                      | ON<br>ON         | 0.3mA typ, 1mA max<br>0.3mA typ, 1mA max   |  |   |   |
| $I_{DD}$                                   | K<br>T               | ON<br>ON         | 0.3mA typ, 1mA max<br>0.3mA typ, 1mA max   | 2mA max                                    | All Digital Inputs High   |   |
|  |                      | ON<br>ON         | 0.05mA typ, 1mA max<br>0.05mA typ, 1mA max |  |   |   |
| $I_{SS}$                                   | K<br>T               | ON<br>ON         | 0.05mA typ, 1mA max<br>0.05mA typ, 1mA max | 2mA max                                    | All Digital Inputs High   |   |
|  |                      | ON<br>ON         | 0.05mA typ, 1mA max<br>0.05mA typ, 1mA max |  |   |   |

## NOTES

<sup>1</sup>KN Version specified for 0 to +70°C; KQ Version for -25°C to +85°C; and TQ, TE Versions for -55°C to +125°C.

<sup>2</sup>Sample tested to ensure compliance.

Specifications subject to change without notice.

## CAUTION

ESD (electrostatic discharge) sensitive device. The digital control inputs are diode protected; however, permanent damage may occur on unconnected devices subject to high energy electrostatic fields. Unused devices must be stored in conductive foam or shunts. The protective foam should be discharged to the destination socket before devices are removed.



## TRUTH TABLES

| AD7506         |                |                |                |                |      |
|----------------|----------------|----------------|----------------|----------------|------|
| A <sub>3</sub> | A <sub>2</sub> | A <sub>1</sub> | A <sub>0</sub> | E <sub>N</sub> | "ON" |
| 0              | 0              | 0              | 0              | 1              | 1    |
| 0              | 0              | 0              | 1              | 1              | 2    |
| 0              | 0              | 1              | 0              | 1              | 3    |
| 0              | 0              | 1              | 1              | 1              | 4    |
| 0              | 1              | 0              | 0              | 1              | 5    |
| 0              | 1              | 0              | 1              | 1              | 6    |
| 0              | 1              | 1              | 0              | 1              | 7    |
| 0              | 1              | 1              | 1              | 1              | 8    |
| 1              | 0              | 0              | 0              | 1              | 9    |
| 1              | 0              | 0              | 1              | 1              | 10   |
| 1              | 0              | 1              | 0              | 1              | 11   |
| 1              | 0              | 1              | 1              | 1              | 12   |
| 1              | 1              | 0              | 0              | 1              | 13   |
| 1              | 1              | 0              | 1              | 1              | 14   |
| 1              | 1              | 1              | 0              | 1              | 15   |
| 1              | 1              | 1              | 1              | 1              | 16   |
| X              | X              | X              | X              | 0              | None |

| AD7507         |                |                |                |        |
|----------------|----------------|----------------|----------------|--------|
| A <sub>2</sub> | A <sub>1</sub> | A <sub>0</sub> | E <sub>N</sub> | "ON"   |
| 0              | 0              | 0              | 1              | 1 & 9  |
| 0              | 0              | 1              | 1              | 2 & 10 |
| 0              | 1              | 0              | 1              | 3 & 11 |
| 0              | 1              | 1              | 1              | 4 & 12 |
| 1              | 0              | 0              | 1              | 5 & 13 |
| 1              | 0              | 1              | 1              | 6 & 14 |
| 1              | 1              | 0              | 1              | 7 & 15 |
| 1              | 1              | 1              | 1              | 8 & 16 |
| X              | X              | X              | 0              | None   |

## PIN CONFIGURATIONS



## LCCC

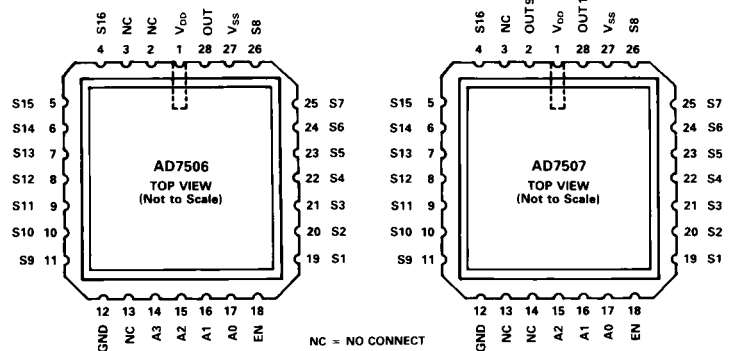

## Typical Performance Characteristics

### 1. R<sub>ON</sub> vs. V<sub>S</sub>

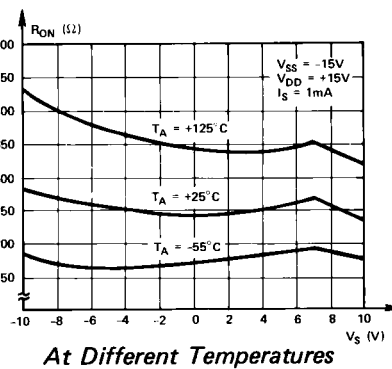
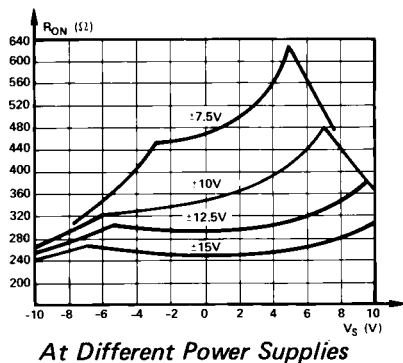

### 2. I<sub>OUT</sub> vs. V<sub>OUT</sub>

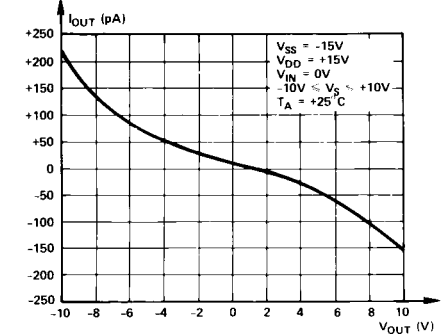

### 3. I<sub>OUT</sub> vs. T<sub>A</sub>

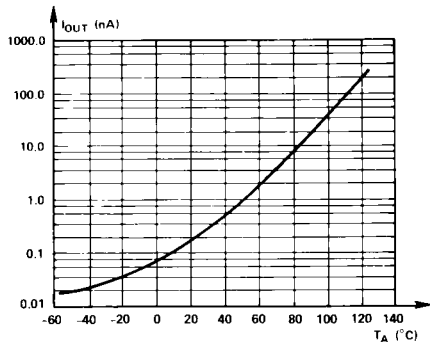

### 4. t<sub>TRANSITION</sub> vs. V<sub>IN</sub>

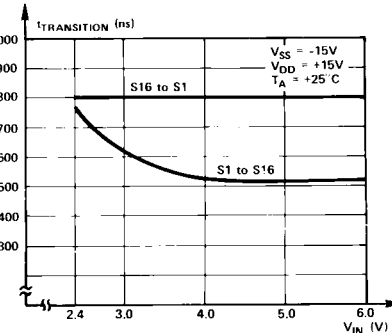

### 5. P<sub>D</sub> vs. Logic Frequency

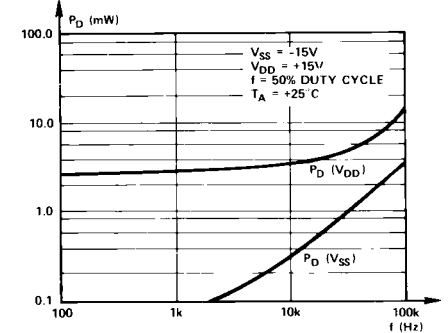

# AD7506/AD7507

## TYPICAL SWITCHING CHARACTERISTICS

### TEST CIRCUIT 1

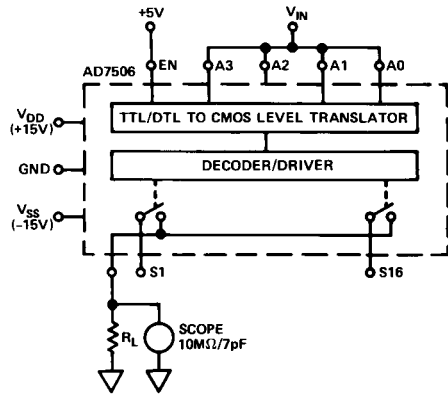

### TEST CIRCUIT 2

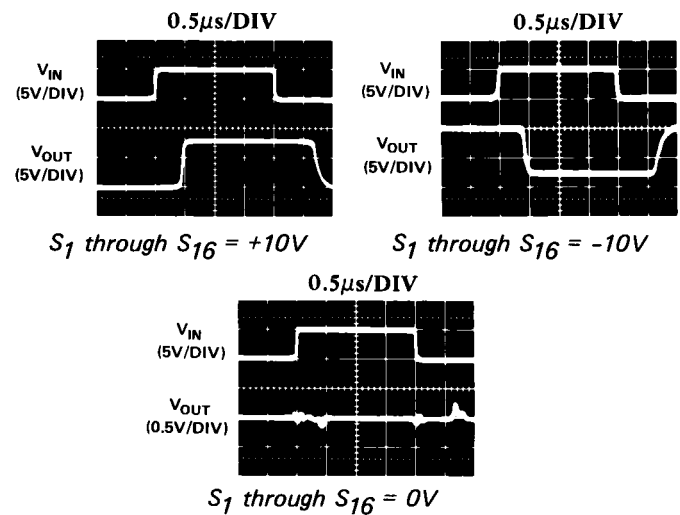
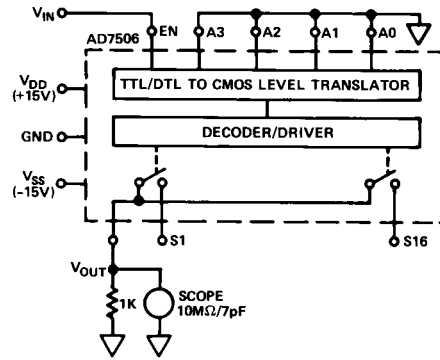

### OUTLINE DIMENSIONS

Dimensions shown in inches and (mm).

#### 28-Pin Plastic DIP (Suffix N)

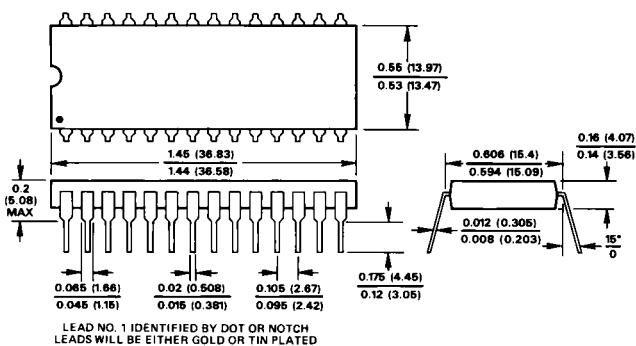

#### 28-Pin Cerdip (Q-28)

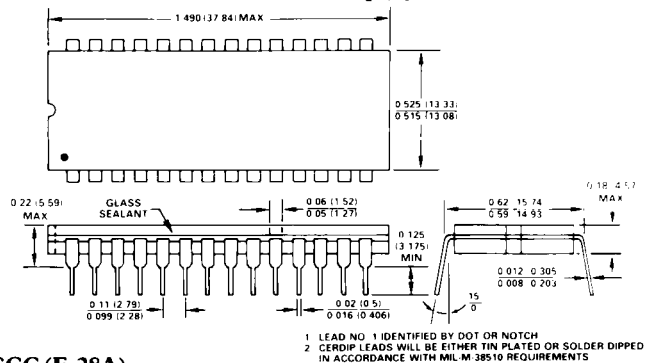

#### 28-Terminal LCCC (E-28A)

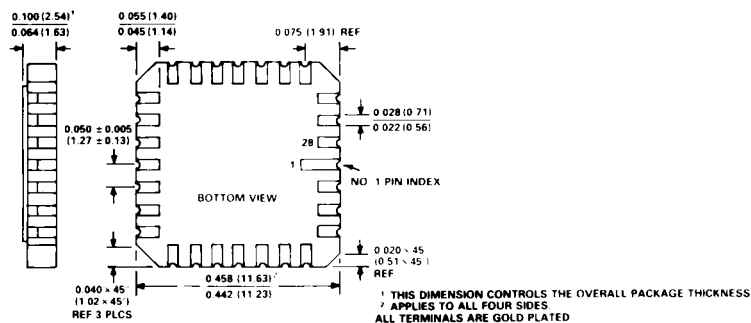

Компания «Life Electronics» занимается поставками электронных компонентов импортного и отечественного производства от производителей и со складов крупных дистрибьюторов Европы, Америки и Азии.

С конца 2013 года компания активно расширяет линейку поставок компонентов по направлению коаксиальный кабель, кварцевые генераторы и конденсаторы (керамические, пленочные, электролитические), за счёт заключения дистрибьюторских договоров

Мы предлагаем:

- Конкурентоспособные цены и скидки постоянным клиентам.
- Специальные условия для постоянных клиентов.
- Подбор аналогов.
- Поставку компонентов в любых объемах, удовлетворяющих вашим потребностям.
- Приемлемые сроки поставки, возможна ускоренная поставка.
- Доставку товара в любую точку России и стран СНГ.
- Комплексную поставку.
- Работу по проектам и поставку образцов.
- Формирование склада под заказчика.
- Сертификаты соответствия на поставляемую продукцию (по желанию клиента).
- Тестирование поставляемой продукции.
- Поставку компонентов, требующих военную и космическую приемку.
- Входной контроль качества.
- Наличие сертификата ISO.

В составе нашей компании организован Конструкторский отдел, призванный помогать разработчикам, и инженерам.

Конструкторский отдел помогает осуществить:

- Регистрацию проекта у производителя компонентов.
- Техническую поддержку проекта.
- Защиту от снятия компонента с производства.
- Оценку стоимости проекта по компонентам.
- Изготовление тестовой платы монтаж и пусконаладочные работы.



Тел: +7 (812) 336 43 04 (многоканальный)

Email: [org@lifeelectronics.ru](mailto:org@lifeelectronics.ru)