

PART NUMBER	SSP-DM0	REV.	A
DATE	E.C.N. NUMBER AND REVISION COMMENTS		REV.
02.28.12	E.C.N. #11809.		A

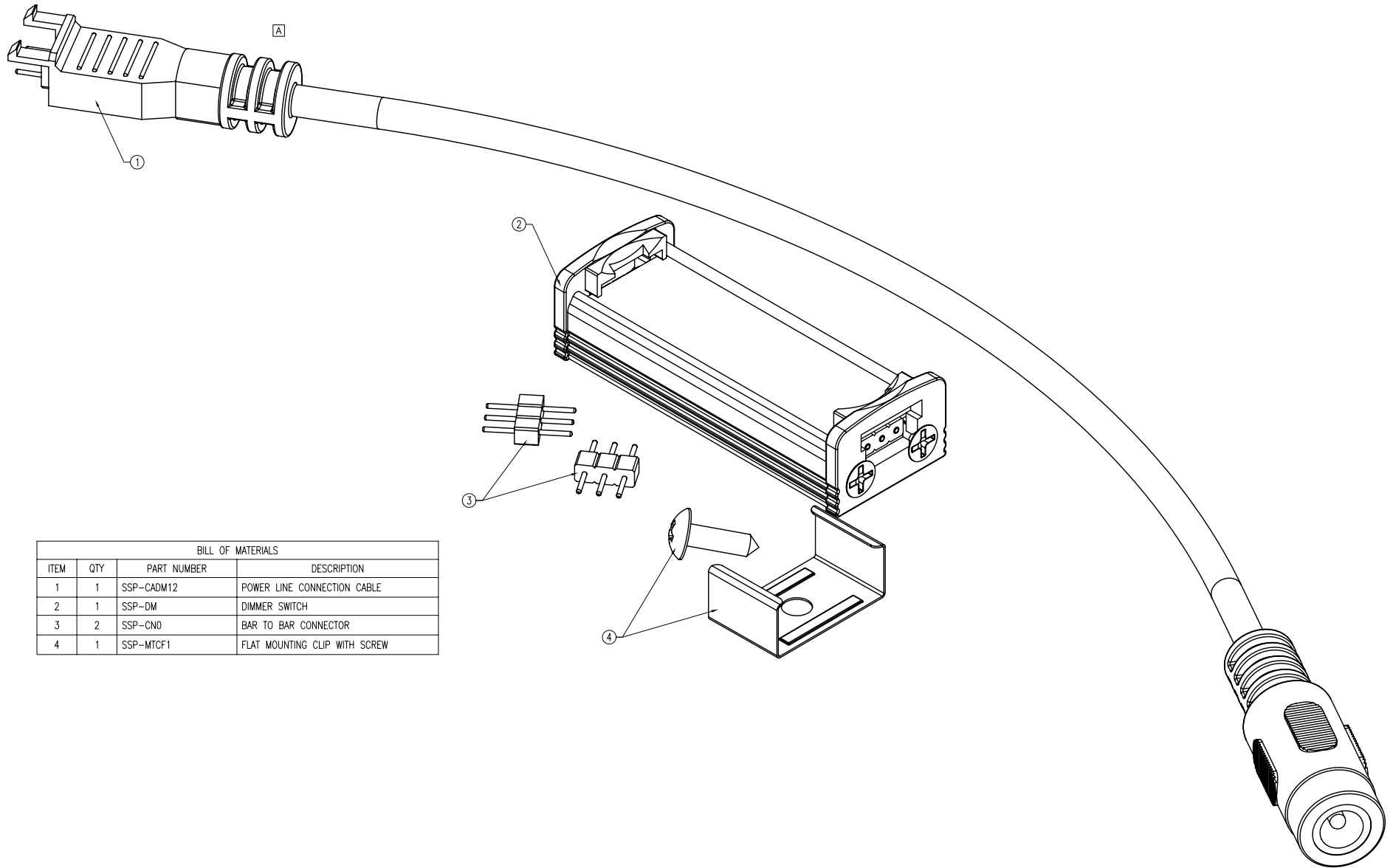

BILL OF MATERIALS			
ITEM	QTY	PART NUMBER	DESCRIPTION
1	1	SSP-CADM12	POWER LINE CONNECTION CABLE
2	1	SSP-DM	DIMMER SWITCH
3	2	SSP-CN0	BAR TO BAR CONNECTOR
4	1	SSP-MTCF1	FLAT MOUNTING CLIP WITH SCREW

*UNLESS OTHERWISE SPECIFIED TOLERANCES PER DECIMAL PRECISION ARE: X=±1 (±0.039), X.X=±0.5 (±0.020), X.XX=±0.25 (±0.010), X.XXX=±0.127 (±0.005). LEAD SIZE=±0.05 (±0.002), LEAD LENGTH=±0.75 (±0.030). MIN.= ^{+0.00}DECIMAL PRECISION MAX.= ^{+0.00}DECIMAL PRECISION _{-0.00}DECIMAL PRECISION



290 E. HELEN ROAD
 PALATINE, IL 60067-6976
 PHONE: +1.847.359.2790
 FAX: +1.847.359.6538
 WEB: WWW.LUMEX.COM

SUNBRITE DIMMER SWITCH KIT FOR MODULAR LED LIGHTBAR.

THE SPECIFICATIONS MAY CHANGE AT ANY TIME WITHOUT NOTICE DUE TO NEW MATERIALS OR PRODUCT IMPROVEMENT.

CONFIDENTIAL INFORMATION
 THE INFORMATION CONTAINED IN THIS DOCUMENT IS THE PROPERTY OF LUMEX INC. EXCEPT AS SPECIFICALLY AUTHORIZED IN WRITING BY LUMEX INC., THE HOLDER OF THIS DOCUMENT SHALL KEEP ALL INFORMATION CONTAINED HEREIN CONFIDENTIAL AND SHALL PROTECT SAME IN WHOLE OR IN PART FROM DISCLOSURE AND DISSEMINATION TO ALL THIRD PARTIES.

DATE:	07.13.11	DRAWN BY:	AB
PAGE:	1 OF 3	CHKD BY:	KF
SCALE:	NTS	APRVD BY:	KF
UNIT:	mm [INCH]		Ⓟ

PART NUMBER	SSP-DMO	REV.	A
DATE	E.C.N. NUMBER AND REVISION COMMENTS		REV.
02.28.12	E.C.N. #11809.		A

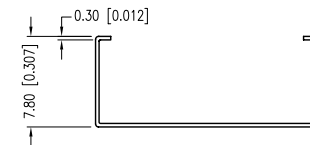
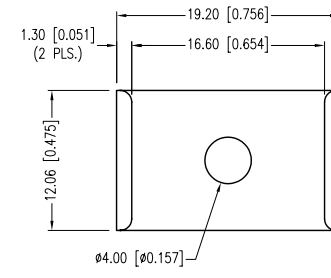
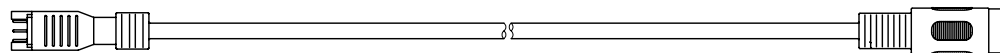
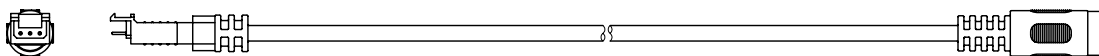
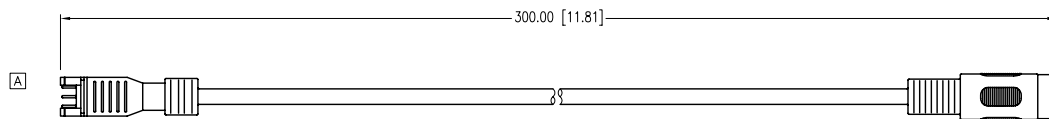
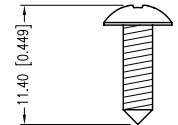
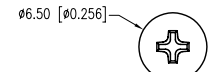
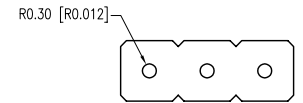
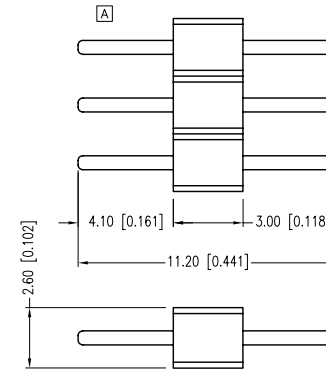
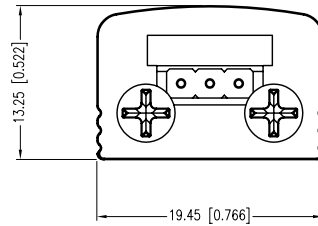
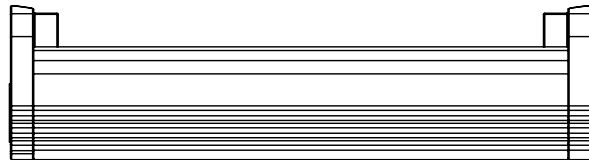

*UNLESS OTHERWISE SPECIFIED TOLERANCES PER DECIMAL PRECISION ARE: X=±1 (±0.039), X.X=±0.5 (±0.020), X.XX=±0.25 (±0.010), X.XXX=±0.127 (±0.005). LEAD SIZE=±0.05 (±0.002), LEAD LENGTH=±0.75 (±0.030). MIN.= +DECIMAL PRECISION MAX.= +0.00 -DECIMAL PRECISION

LUMEX
 Creating LED and LCD Solutions Together™
 290 E. HELEN ROAD
 PALATINE, IL 60067-6976
 PHONE: +1.847.359.2790
 FAX: +1.847.359.6538
 WEB: WWW.LUMEX.COM

SUNBRITE DIMMER SWITCH KIT FOR MODULAR LED LIGHTBAR.
 THE SPECIFICATIONS MAY CHANGE AT ANY TIME WITHOUT NOTICE DUE TO NEW MATERIALS OR PRODUCT IMPROVEMENT.
 CONFIDENTIAL INFORMATION
 THE INFORMATION CONTAINED IN THIS DOCUMENT IS THE PROPERTY OF LUMEX INC. EXCEPT AS SPECIFICALLY AUTHORIZED IN WRITING BY LUMEX INC., THE HOLDER OF THIS DOCUMENT SHALL KEEP ALL INFORMATION CONTAINED HEREIN CONFIDENTIAL AND SHALL PROTECT SAME IN WHOLE OR IN PART FROM DISCLOSURE AND DISSEMINATION TO ALL THIRD PARTIES.

DATE:	07.13.11	DRAWN BY:	AB
PAGE:	2 OF 3	CHKD BY:	KF
SCALE:	NTS	APRVD BY:	KF
UNIT:	mm [INCH]		Ⓟ

PART NUMBER	SSP-DM0	REV.	A
DATE	E.C.N. NUMBER AND REVISION COMMENTS		REV.
02.28.12	E.C.N. #11809.		A

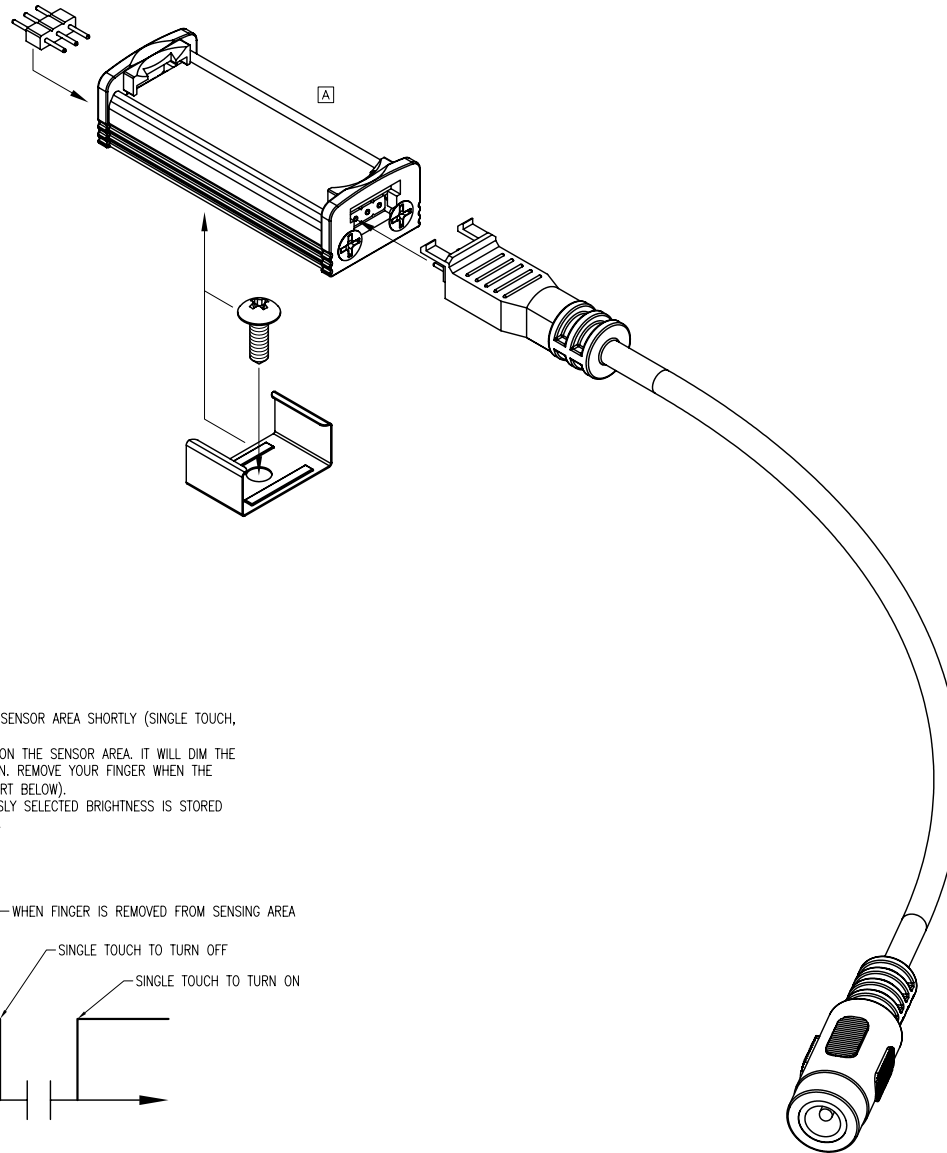

OPERATION DESCRIPTION

1. ON/OFF: USE YOUR FINGER TO TOUCH THE SENSOR AREA SHORTLY (SINGLE TOUCH, ~0.5 SECONDS, SEE CHART BELOW).
2. DIMMING: CONTINUE TO HOLD YOUR FINGER ON THE SENSOR AREA. IT WILL DIM THE LIGHTBAR BRIGHTNESS IN A CYCLING PATTERN. REMOVE YOUR FINGER WHEN THE DESIRED BRIGHTNESS IS ACHIEVED (SEE CHART BELOW).
3. BRIGHTNESS SETTING MEMORY: THE PREVIOUSLY SELECTED BRIGHTNESS IS STORED UNTIL THE ADAPTOR PLUG IS DISCONNECTED.

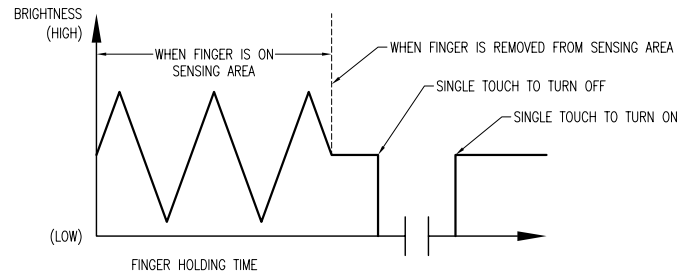

*UNLESS OTHERWISE SPECIFIED TOLERANCES PER DECIMAL PRECISION ARE: X=±1 (±0.039), X.X=±0.5 (±0.020), X.XX=±0.25 (±0.010), X.XXX=±0.127 (±0.005). LEAD SIZE=±0.05 (±0.002), LEAD LENGTH=±0.75 (±0.030). MIN.= ^{+0.00} DECIMAL PRECISION MAX.= ^{-0.00} DECIMAL PRECISION



290 E. HELEN ROAD
 PALATINE, IL 60067-6976
 PHONE: +1.847.359.2790
 FAX: +1.847.359.6538
 WEB: WWW.LUMEX.COM

SUNBRITE DIMMER SWITCH KIT FOR MODULAR LED LIGHTBAR.

THE SPECIFICATIONS MAY CHANGE AT ANY TIME WITHOUT NOTICE DUE TO NEW MATERIALS OR PRODUCT IMPROVEMENT.

CONFIDENTIAL INFORMATION
 THE INFORMATION CONTAINED IN THIS DOCUMENT IS THE PROPERTY OF LUMEX INC. EXCEPT AS SPECIFICALLY AUTHORIZED IN WRITING BY LUMEX INC., THE HOLDER OF THIS DOCUMENT SHALL KEEP ALL INFORMATION CONTAINED HEREIN CONFIDENTIAL AND SHALL PROTECT SAME IN WHOLE OR IN PART FROM DISCLOSURE AND DISSEMINATION TO ALL THIRD PARTIES.

DATE:	07.13.11	DRAWN BY:	AB
PAGE:	3 OF 3	CHKD BY:	KF
SCALE:	NTS	APRVD BY:	KF
UNIT:	mm [INCH]		Ⓟ

Компания «Life Electronics» занимается поставками электронных компонентов импортного и отечественного производства от производителей и со складов крупных дистрибьюторов Европы, Америки и Азии.

С конца 2013 года компания активно расширяет линейку поставок компонентов по направлению коаксиальный кабель, кварцевые генераторы и конденсаторы (керамические, пленочные, электролитические), за счёт заключения дистрибьюторских договоров

Мы предлагаем:

- Конкурентоспособные цены и скидки постоянным клиентам.
- Специальные условия для постоянных клиентов.
- Подбор аналогов.
- Поставку компонентов в любых объемах, удовлетворяющих вашим потребностям.
- Приемлемые сроки поставки, возможна ускоренная поставка.
- Доставку товара в любую точку России и стран СНГ.
- Комплексную поставку.
- Работу по проектам и поставку образцов.
- Формирование склада под заказчика.
- Сертификаты соответствия на поставляемую продукцию (по желанию клиента).
- Тестирование поставляемой продукции.
- Поставку компонентов, требующих военную и космическую приемку.
- Входной контроль качества.
- Наличие сертификата ISO.

В составе нашей компании организован Конструкторский отдел, призванный помогать разработчикам, и инженерам.

Конструкторский отдел помогает осуществить:

- Регистрацию проекта у производителя компонентов.
- Техническую поддержку проекта.
- Защиту от снятия компонента с производства.
- Оценку стоимости проекта по компонентам.
- Изготовление тестовой платы монтаж и пусконаладочные работы.



Тел: +7 (812) 336 43 04 (многоканальный)

Email: org@lifeelectronics.ru