

SERIES: VSK-S5-T | DESCRIPTION: AC-DC POWER SUPPLY
FEATURES

- up to 5.5 W continuous output
- encapsulated compact case
- universal input (85~264 Vac/110~370 Vdc)
- single regulated output from 3.3~24 Vdc
- over voltage, over temperature, and short circuit protections
- UL/cUL safety approvals
- efficiency up to 83%



MODEL	output voltage	output current	output power	ripple and noise ¹	efficiency
	(Vdc)	max (mA)	max (W)	max (mVp-p)	max (%)
VSK-S5-3R3UA-T	3.3	1250	4.125	120	74
VSK-S5-5UA-T	5	1000	5	120	78
VSK-S5-9UA-T	9	550	5	100	78
VSK-S5-12UA-T	12	420	5	100	80
VSK-S5-15UA-T	15	333	5	100	82
VSK-S5-24UA-T	24	230	5.5	100	83

Notes: 1. Ripple and noise are measured at 20 MHz BW by "parallel cable" method with 1 μ F ceramic and 10 μ F electrolytic capacitors on the output.

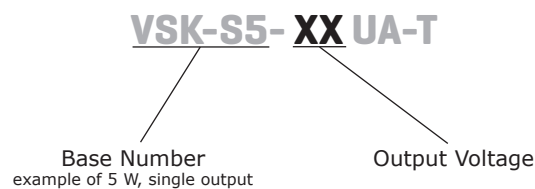
PART NUMBER KEY

INPUT

parameter	conditions/description	min	typ	max	units
voltage		85		264	Vac
		110		370	Vdc
frequency		47		63	Hz
current	at 110 Vac		110		mA
	at 230 Vac		70		mA
inrush current	at 110 Vac		10		A
	at 230 Vac		20		A
input fuse	1 A/250 V, slow-blow type (internal, included)				
temperature coefficient			±0.02		%/°C

OUTPUT

parameter	conditions/description	min	typ	max	units
capcitive load ¹	3.3 Vdc model			4000	μF
	5 Vdc model			4000	μF
	9 Vdc model			1000	μF
	12 Vdc model			820	μF
	15 Vdc model			820	μF
	24 Vdc model			330	μF
line regulation			±0.5		%
load regulation	at 10~100% load		±1		%
voltage set accuracy	3.3 Vdc model		±3		%
	all other models		±2		%
hold-up time	at 110 Vac		12		ms
	at 230 Vac		80		ms
switching frequency				140	kHz

Notes: 1. Test without external circuit

PROTECTIONS

parameter	conditions/description	min	typ	max	units
over voltage protection	shutdown				
over current protection	auto recovery	110			%
short circuit protection	hiccup, auto recovery				

SAFETY & COMPLIANCE

parameter	conditions/description	min	typ	max	units
isolation voltage	for 1 minute	4,000			Vac
safety approvals	UL60950-1				
safety class	Class II				
conducted emissions	CISPR22/EN55022, Class B				
radiated emissions	CISPR22/EN55022, Class B				
ESD	IEC/EN61000-4-2 Class B, contact ±6 kV / air ±8 kV				
radiated immunity	IEC/EN61000-4-3 Class A, 10V/m				
EFT/burst	IEC/EN61000-4-4 Class B, ±2 kV				
	IEC/EN61000-4-4 Class B, ±4 kV (external circuit required, see figure 2)				
surge	IEC/EN61000-4-5 Class B, ±1 kV / ±2 kV				
	IEC/EN61000-4-5 Class B, ±2 kV / ±4 kV (external circuit required, see figure 2)				
conducted immunity	IEC/EN61000-4-6 Class A, 10 Vr.m.s				

SAFETY & COMPLIANCE (CONTINUED)

parameter	conditions/description	min	typ	max	units
PFM	IEC/EN61000-4-8 Class A, 10 A/m				
voltage dips & interruptions	IEC/EN61000-4-11 Class B, 0%-70%				
MTBF	as per MIL-HDBK-217F, at 25 °C	300,000			hours
RoHS	2011/65/EU				

ENVIRONMENTAL

parameter	conditions/description	min	typ	max	units
operating temperature	see derating curves	-25		70	°C
storage temperature		-25		105	°C
storage humidity	non-condensing			95	%

DERATING CURVES

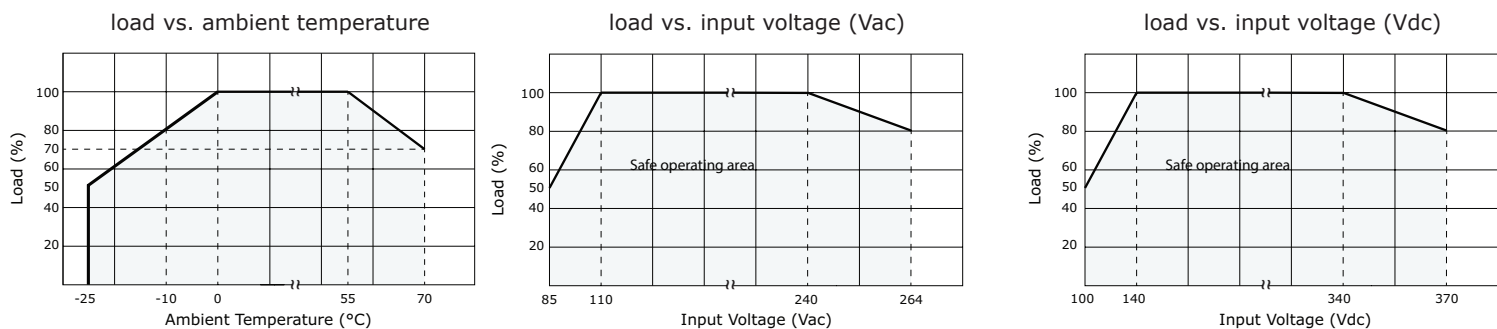

EFFICIENCY CURVES

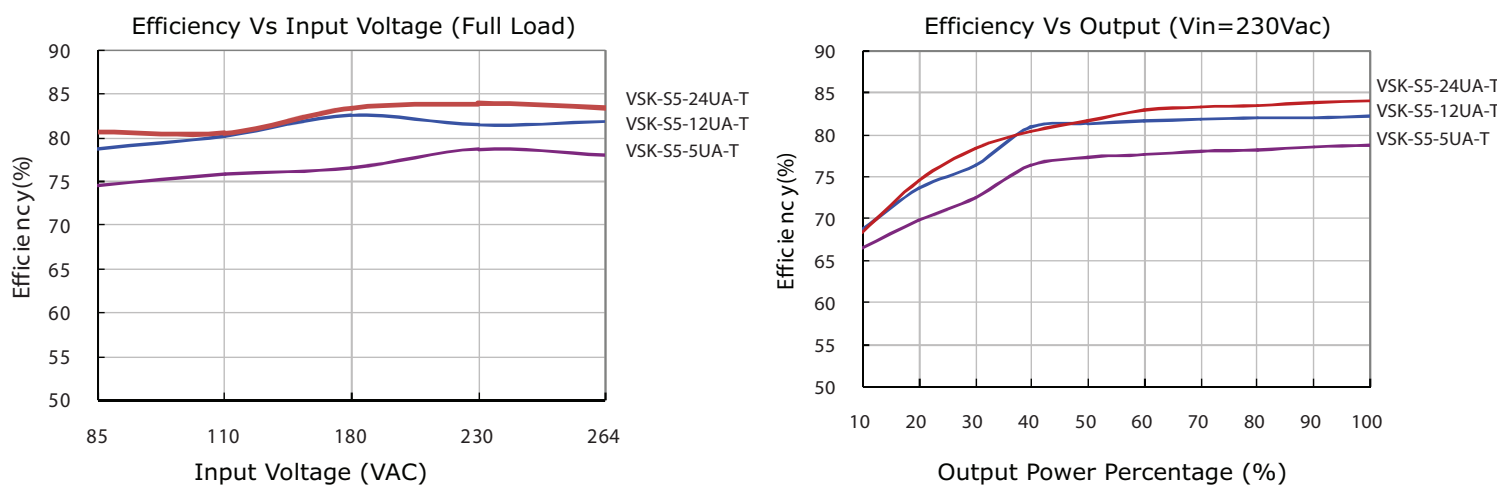

MECHANICAL

parameter	conditions/description	min	typ	max	units
dimensions	76.0 x 31.50 x 23.96 (2.992 x 1.240 x 0.943 inch)				mm
material	UL94V-0				
weight			52		g

MECHANICAL DRAWING

units: mm [inch]
 tolerance: ±0.50 [±0.020]

wire range: 24~12 AWG

PIN CONNECTIONS	
PIN	FUNCTION
1	AC(N)
2	AC(L)
3	+Vo
4	-Vo

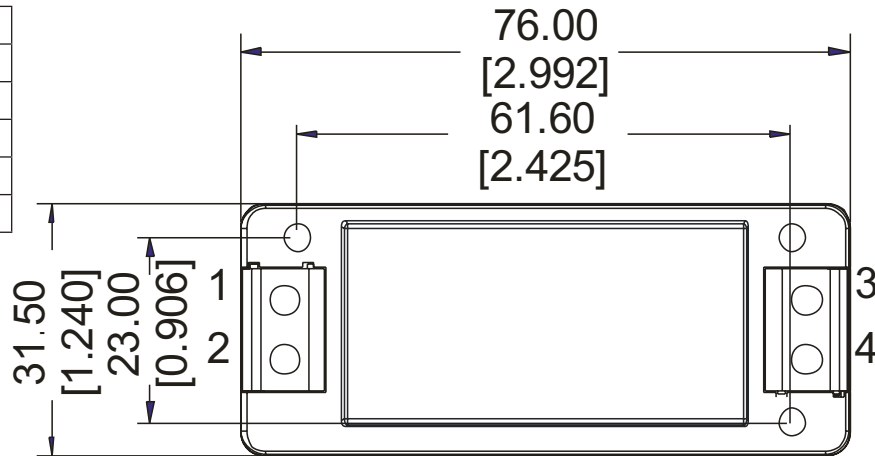

Top View

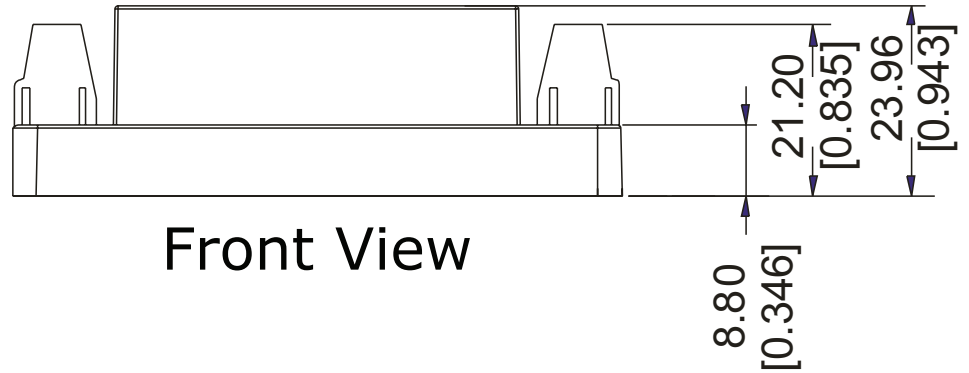

Front View

TYPICAL APPLICATION CIRCUIT

Figure 1

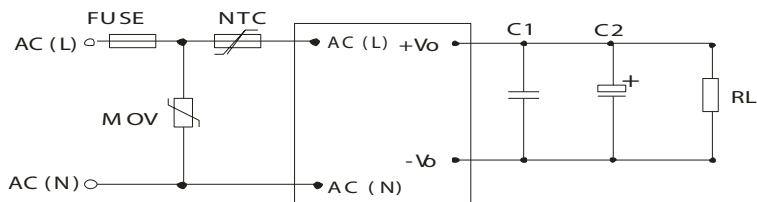

Table 1

Recommended External Circuit Components					
MODEL	C1 ¹ (μF)	C2 ¹ (μF)	FUSE	NTC	MOV
VSK-S5-3R3UA-T	1	220	1 A/250 V	12D-5	S14K350
VSK-S5-5UA-T	1	220	1 A/250 V	12D-5	S14K350
VSK-S5-9UA-T	1	100	1 A/250 V	12D-5	S14K350
VSK-S5-12UA-T	1	100	1 A/250 V	12D-5	S14K350
VSK-S5-15UA-T	1	100	1 A/250 V	12D-5	S14K350
VSK-S5-24UA-T	1	47	1 A/250 V	12D-5	S14K350

Note: 1. Output filtering capacitor C1 is a ceramic capacitor that is used to filter high frequency noise. C2 is an electrolytic capacitor. It is recommended to use high frequency and low impedance electrolytic capacitors. For capacitance and current of capacitor please refer to the manufacturer's datasheet. Voltage derating of capacitor should be 80% or above.

EMC RECOMMENDED CIRCUIT

Figure 2

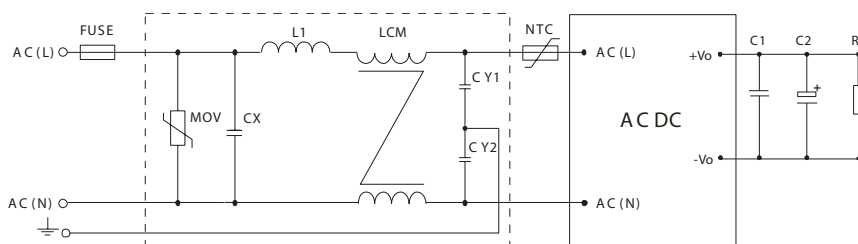

Table 2

Recommended External Circuit Components	
FUSE	1A/250V, slow fusing, necessary
MOV	S14K350
CY1, CY2	1nF/400VAC
CX	0.1μF/275VAC
LCM	2.2mH
L1	4.7μH/2.0A
C1, C2	see Table 1

Note: 1. All specifications measured at Ta=25°C, humidity <75%, nominal input voltage, and rated output load, unless otherwise specified.

REVISION HISTORY

rev.	description	date
1.0	initial release	09/06/2012
1.01	updated mechanical drawing and product photo	11/28/2012
1.02	updated spec	03/08/2013
1.03	updated spec	08/23/2013
1.04	updated spec	01/08/2014
1.05	changed internal IC, updated datasheet	06/05/2015

The revision history provided is for informational purposes only and is believed to be accurate.



CUI INC[®]

Headquarters
20050 SW 112th Ave.
Tualatin, OR 97062
800.275.4899

Fax 503.612.2383
cui.com
techsupport@cui.com

CUI offers a two (2) year limited warranty. Complete warranty information is listed on our website.

CUI reserves the right to make changes to the product at any time without notice. Information provided by CUI is believed to be accurate and reliable. However, no responsibility is assumed by CUI for its use, nor for any infringements of patents or other rights of third parties which may result from its use.

CUI products are not authorized or warranted for use as critical components in equipment that requires an extremely high level of reliability. A critical component is any component of a life support device or system whose failure to perform can be reasonably expected to cause the failure of the life support device or system, or to affect its safety or effectiveness.

Компания «Life Electronics» занимается поставками электронных компонентов импортного и отечественного производства от производителей и со складов крупных дистрибьюторов Европы, Америки и Азии.

С конца 2013 года компания активно расширяет линейку поставок компонентов по направлению коаксиальный кабель, кварцевые генераторы и конденсаторы (керамические, пленочные, электролитические), за счёт заключения дистрибьюторских договоров

Мы предлагаем:

- Конкурентоспособные цены и скидки постоянным клиентам.
- Специальные условия для постоянных клиентов.
- Подбор аналогов.
- Поставку компонентов в любых объемах, удовлетворяющих вашим потребностям.
- Приемлемые сроки поставки, возможна ускоренная поставка.
- Доставку товара в любую точку России и стран СНГ.
- Комплексную поставку.
- Работу по проектам и поставку образцов.
- Формирование склада под заказчика.
- Сертификаты соответствия на поставляемую продукцию (по желанию клиента).
- Тестирование поставляемой продукции.
- Поставку компонентов, требующих военную и космическую приемку.
- Входной контроль качества.
- Наличие сертификата ISO.

В составе нашей компании организован Конструкторский отдел, призванный помогать разработчикам, и инженерам.

Конструкторский отдел помогает осуществить:

- Регистрацию проекта у производителя компонентов.
- Техническую поддержку проекта.
- Защиту от снятия компонента с производства.
- Оценку стоимости проекта по компонентам.
- Изготовление тестовой платы монтаж и пусконаладочные работы.



Тел: +7 (812) 336 43 04 (многоканальный)

Email: org@lifeelectronics.ru