



DATA SHEET

SE2622L: 2.4 GHz, 256 QAM Power Amplifier

Applications

- DSSS 2.4 GHz WLAN (IEEE 802.11b)
- OFDM 2.4 GHz WLAN (IEEE 802.11g)
- OFDM 2.4 GHz WLAN (IEEE 802.11n)
- OFDM 2.4 GHz WLAN (256 QAM)
- Access points, PCMCIA, PC cards

Features

- Single 3.3 V supply operation:
 - 18 dBm, EVM = –35 dB, 256 QAM OFDM
 - 20 dBm, EVM = –30 dB, 802.11n
 - 23 dBm, ACPR < –32 dBc, 802.11b
- Small signal gain: 31 dB typical
- Integrated temperature compensated power detector
- Digital power amplifier enable pin (VEN)
- Lead Free, Halogen Free and RoHS compliant
- Small footprint QFN (16-pin, 3 × 3 × 0.9 mm) package (MSL1, 260 °C per JEDEC J-STD-020)



Skyworks Green™ products are compliant with all applicable legislation and are halogen-free. For additional information, refer to *Skyworks Definition of Green™*, document number SQ04-0074.

Description

The SE2622L is a 2.4 GHz power amplifier designed for use in the 2.4 GHz ISM band for wireless LAN applications. The device incorporates a power detector for closed loop monitoring of the output power.

The SE2622L includes a digital enable control for device on/off control.

The SE2622L temperature compensated power detector is highly immune to mismatch at its output with less than 1.5 dB of variation with a 2:1 mismatch. The device package and pinout for the 16-pin QFN are shown in Figure 1. A block diagram of the SE2622L is shown in Figure 2.

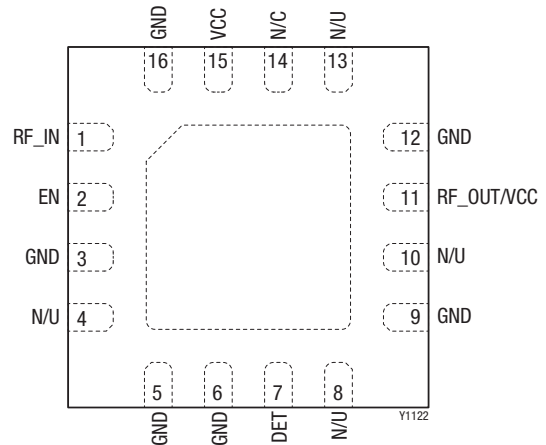

Figure 1. SE2622L Pinout – 16-Pin QFN (Top View)

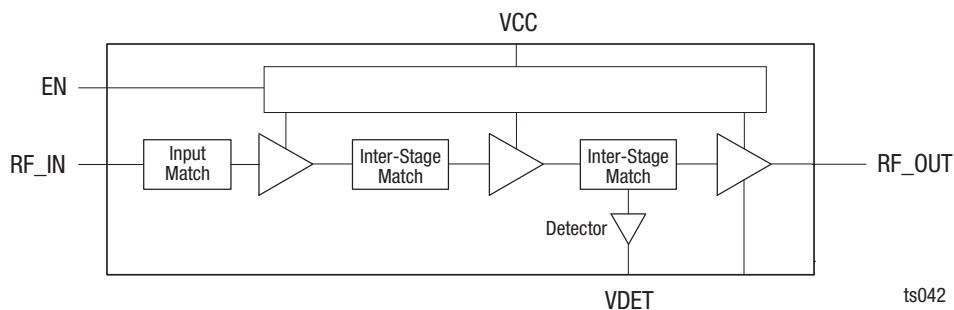

Figure 2. SE2622L Block Diagram

Electrical and Mechanical Specifications

Signal pin assignments and functional pin descriptions are described in Table 1. The absolute maximum ratings of the SE2622L are provided in Table 2. Recommended operating

conditions are specified in Table 3. Electrical specifications are provided in Tables 4, 5, and 6.

Typical performance characteristics of the SE2622L are illustrated in Figure 3.

Table 1. SE2622L Signal Descriptions

Pin	Name	Description	Pin	Name	Description
1	RF_IN	Power amplifier RF input; DC block required	10	N/U	Not used
2	EN	Digital pin used to power up and power down the IC	11	RF_OUT/VCC	Power Amplifier RF output / Final stage collector supply
3	GND	Ground	12	GND	Ground
4	N/U	Not used	13	N/U	Not used
5,6	GND	Ground	14	N/C	No connect
7	DET	Analog power detector output	15	VCC	Stages 1, 2 collector supply
8	N/U	Not used	16	GND	Ground
9	GND	Ground	Paddle	GND	Exposed die paddle; electrical and thermal ground

Table 2. SE2622L Absolute Maximum Ratings (Note 1)

Parameter	Symbol	Minimum	Maximum	Units
Supply voltage on pins Vcc	Vcc	-0.3	+4	V
Power amplifier enable	VEN	-0.3	+3.6	V
RF input power, RF_OUT terminated into 50 Ω match	RFIN		+10	dBm
Storage temperature range	TSTG	-40	+150	°C
Electrostatic discharge: Human Body Model (HBM), Class 1B	ESD		500	V

Note 1: Exposure to maximum rating conditions for extended periods may reduce device reliability. There is no damage to device with only one parameter set at the limit and all other parameters set at or below their nominal value. Exceeding any of the limits listed here may result in permanent damage to the device.

CAUTION: Although this device is designed to be as robust as possible, electrostatic discharge (ESD) can damage this device. This device must be protected at all times from ESD. Static charges may easily produce potentials of several kilovolts on the human body or equipment, which can discharge without detection. Industry-standard ESD precautions should be used at all times.

Table 3. SE2622L Recommended Operating Conditions

Parameter	Symbol	Minimum	Maximum	Units
Supply voltage	Vcc	3.0	3.6	V
Supply voltage on pins VCC3	Vcc3	3.0	3.6	V
Ambient temperature	TA	-40	85	°C

Table 4. SE2622L Electrical Specifications: DC Characteristics (Note 1)
(Vcc = Vcc3 = VEN = 3.3 V, TA = +25 °C, as Measured on Evaluation Board, Unless Otherwise Noted)

Parameter	Symbol	Test Condition	Min	Typical	Max	Units
Supply current (Sum of Vcc0, Vcc, Vcc3)	Icc-802.11b	POUT = +23 dBm, 11 Mbps CCK signal, BT = 0.45, Vcc = Vcc3 = 3.3 V		250		mA
Supply current (Sum of Vcc, Vcc3)	Icc-802.11g	Pout = +19 dBm, 54 Mbps OFDM signal, Vcc = Vcc3 = 3.3 V		175		mA
Supply current (Sum of Vcc, Vcc3)	ICQ	No RF		125		mA
Supply current	IOFF	VEN = 0 V, No RF		2	10	μA
Logic high voltage	VENH		1.3		Vcc	V
Logic low voltage	VENL		0		0.5	V
Input current logic high voltage	IENH			300		μA
Input current logic low voltage	IENL			<1		μA
Enable pin input impedance	ZEN	Passive pull down		10		kΩ

Note 1: Performance is guaranteed only under the conditions listed in this table.

Table 5. SE2622L Electrical Specifications: AC Characteristics (Note 1)
(Vcc = Vcc3 = VEN = 3.3 V, f = 2.45 GHz, TA = +25 °C, as Measured on Evaluation Board, Unless Otherwise Noted)

Parameter	Symbol	Test Condition	Min	Typ	Max	Units
Frequency range	f		2400		2500	MHz
Output power	POUT	OFDM, 256 QAM, HT40, -35 dB EVM		+18		dBm
		OFDM, 256 QAM, HT20, -35 dB EVM		+19		
		OFDM, 256 QAM, HT40, -38 dB EVM		+16		
		OFDM, 64 QAM, HT20, -30 dB EVM		+20		
		CCK signal, BT = 0.045, Mask		+23		
		802.11n, HT20, all data rates, Mask		+23		
		802.11n, HT40, all data rates, Mask		+22		
Output 1dB compression point	P1dB	No modulation	+24.5	+27		dBm
Input return loss	S11			-12	-10	dB
Small signal gain	S21	PIN = -25 dBm	26	31	34	dB
Gain Variation over band	ΔS21	PIN = -25 dBm, f = 2400 to 2500 MHz		1		dB
Harmonic	2f	POUT = +23 dBm, CW		-50		dBm/MHz
	3f			-50		dBm/MHz
Rise and fall time	tr, tf			0.5		μs
Stability	STAB	POUT = +23 dBm, 54 Mbps OFDM signal, 64 QAM, VSWR = 6:1. All Phases	All non-harmonically related outputs less than -50 dBc/100 kHz			
Tolerance to output load mismatching	VSVR	POUT = +23 dBm, 54 Mbps OFDM signal, 64 QAM, VSWR = 10:1. All Phases	No damage			

Note 1: Performance is guaranteed only under the conditions listed in this table.

Table 6. SE2622L Electrical Specifications: Power Detector Characteristics (Note 1)
 (Vcc = Vcc3 = VEN = 3.3 V, f = 2.45 GHz, TA = +25 °C, as Measured on Evaluation Board, Unless Otherwise Noted)

Parameter	Symbol	Test Condition	Min	Typical	Max	Units
POUT detect range	PDR		0		P1dB	dBm
Detector voltage	VDET	POUT = +23 dBm		1.04		V
Detector voltage	VDET	POUT = +21 dBm		0.87		V
Detector voltage	VDET	POUT = No RF		0.33		V
Output impedance	PDZOUT			2.3		kΩ
DC load impedance	PDZLOAD		10			kΩ

Note 1: Performance is guaranteed only under the conditions listed in this table.

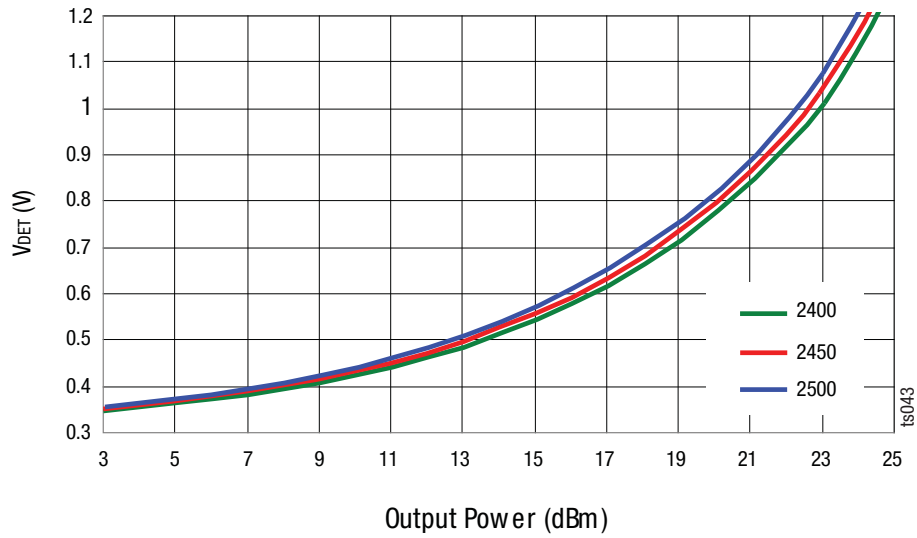

Figure 3. SE2622L Power Detector Characteristics

Evaluation Board Test Procedure

1. Connect GND to all ground pins.
2. Connect a power supply to the VCC1, VCC2, and the two RF_OUT pins.
3. If desired, connect a voltage meter to the VDET pin.
4. Connect a +3.3 V supply to EN pin.
5. Connect a signal generator to the RF signal input port. Set it to the desired RF frequency at a power level of –30 dBm or less to the Evaluation Board. DO NOT enable the RF signal.
6. Connect a spectrum analyzer to the RF signal output port.

7. Enable the power supply.
8. Enable the RF signal.
9. Take measurements.

CAUTION: *If the input signal exceeds the rated power, the Evaluation Board can be permanently damaged.*

NOTE: *It is important to adjust the VCC voltage source so that the target supply voltage (+5) is measured at the board. The high collector currents will drop the collector voltage significantly if long leads are used. Adjust the bias voltage to compensate."*

Table 7. SE2622L Evaluation Board Bill of Materials

Component	Part number	Description	Manufacturer
U1	SE2622L		Skyworks
PCB	Z053-B		Skyworks
R1, C2, C5, C6, C10, C13, C19	DNI		
C3, C9	10 pF	GRM1555C1H100JZ01	Murata
C4	1500 pF	GRM155R71H152KA01	Murata
C11	4.7 μF	GRM188R60J475KE19	Murata
C14	1.8 pF	GRM1555C1H1R8CZ01	Murata
C15	15 pF	GRM1555C1H150JZ01	Murata
C16	1.5 pF	GRM1555C1H1R5CZ01	Murata
C17	1.0 pF	GRM1555C1H1R0CZ01	Murata
J1, J2	SMA	142-0701-851	Johnson
J3	HEADER 6	22-28-4063	Molex
L2	4.7 nH	LQG18HN4N7S00D	Murata
L3	1.5 nH	LQG15HN1N5S02D	Murata

Package Dimensions

The PCB layout footprint for the SE2622L is provided in Figure 5. Typical case markings are shown in Figure 6. Package dimensions for the 16-pin QFN are shown in Figure 7, and tape and reel dimensions are provided in Figure 8.

Package and Handling Information

Because of its sensitivity to moisture absorption, instructions on the shipping container label must be followed regarding exposure to moisture after the container seal is broken, otherwise, problems related to moisture absorption may occur when the part is subjected to high temperature during solder assembly. The SE2622L is capable of withstanding a Pb free solder reflow. Care

must be taken when attaching this product, whether it is done manually or in a production solder reflow environment. If the part is manually attached, precaution should be taken to insure that the device is not subjected to temperatures above its rated peak temperature for an extended period of time. For details on both attachment techniques, precautions, and handling procedures recommended by Skyworks, please refer to:

- Skyworks Application Note: *Quad Flat No-Lead Module Solder Reflow & Rework Information*, Document Number QAD-00045.
- Skyworks Application Note: *Handling, Packing, Shipping and Use of Moisture Sensitive QFN*, Document Number QAD-00044.

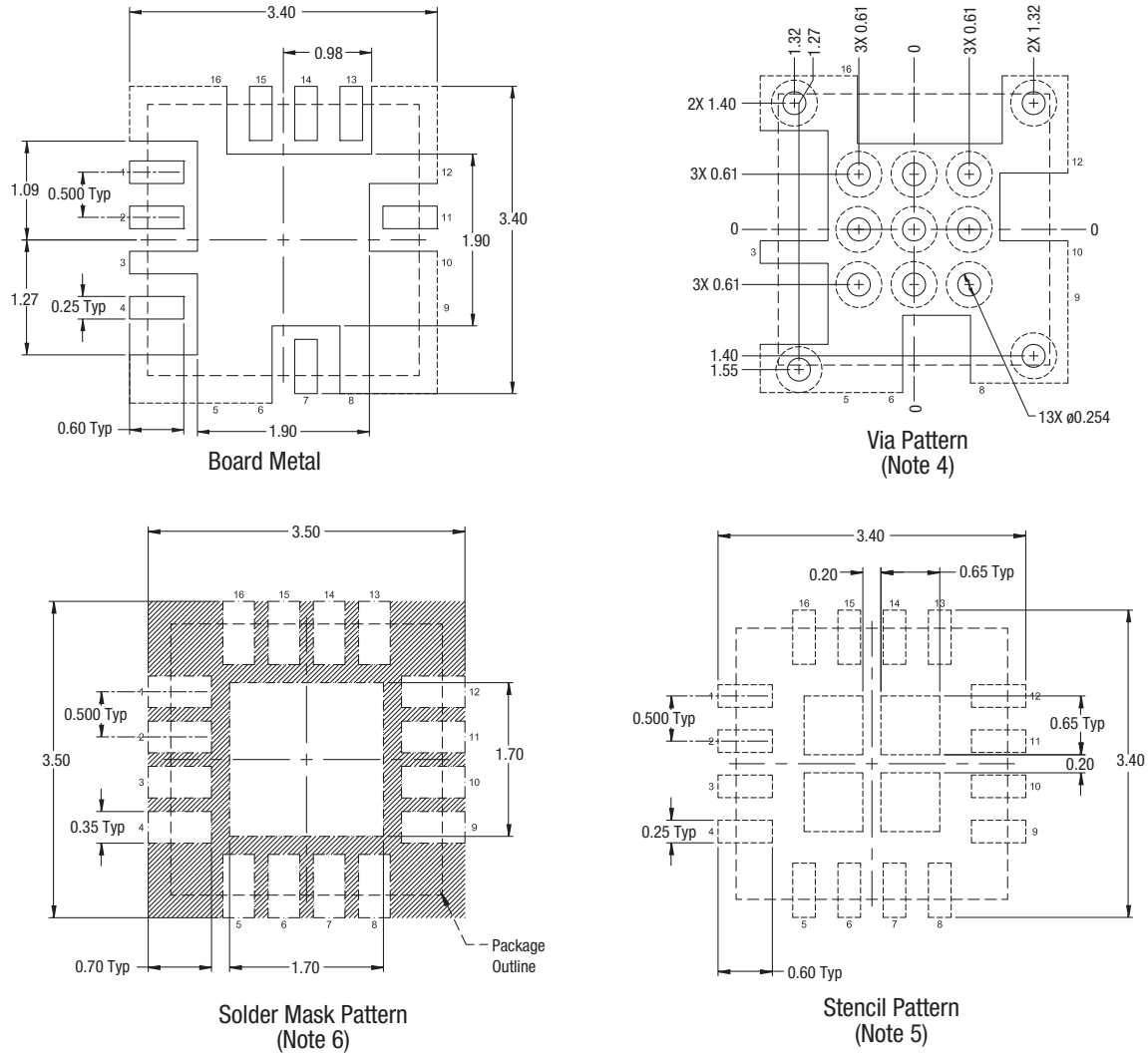

- Notes:**
1. All dimensions are in millimeters.
 2. Dimensions and tolerances according to ASME Y14.5M-1994.
 3. Unless specified, dimensions are symmetrical about center lines.
 4. Via hole recommendations: 0.025 mm Cu via wall plating (minimum), via hole to be filled with conductive paste and plated over.
 5. Stencil recommendations: 0.125 mm stencil thickness, laser cut apertures, trapezoidal walls and rounded corners offer better paste release.
 6. Solder mask recommendations: contact board fabricator for recommended solder mask offset and tolerance.

Y1177

Figure 5. PCB Layout Footprint for the SE2622L

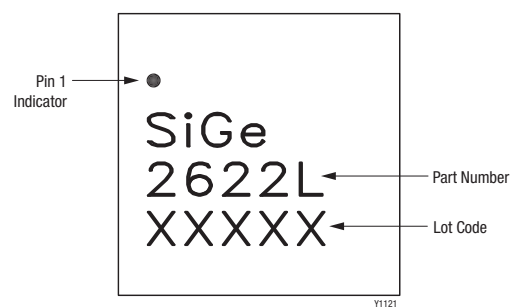
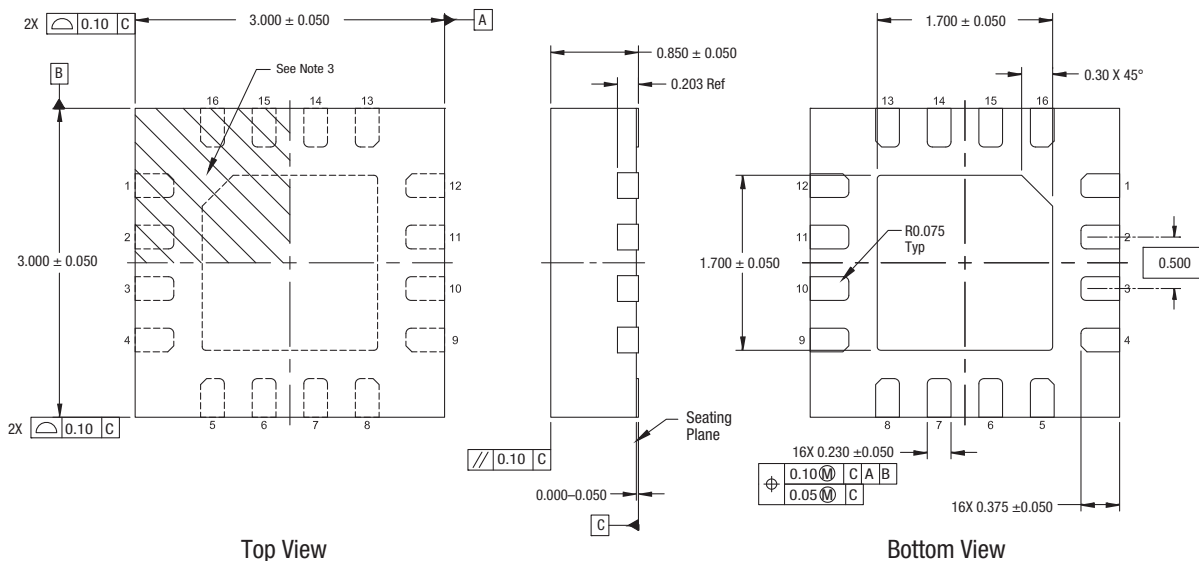

Figure 6. Typical Case Markings (Top View)



Notes:

1. Dimensions and tolerances according to ASME Y14.5M-1994.
2. All measurements are in millimeters.
 Unless otherwise specified, the following values apply:
 Decimal Tolerance: Angular Tolerance:
 X.X (1 place) ± 0.1 mm ± 0.5°
 X.XX (2 places) ± 0.05 mm
 X.XXX (3 places) ± 0.025 mm
3. Terminal 1 identification mark located within marked area.
4. Unless specified, dimensions are symmetrical about center lines.

Y1123

Figure 7. SE2622L 16-Pin QFN Package Dimensions

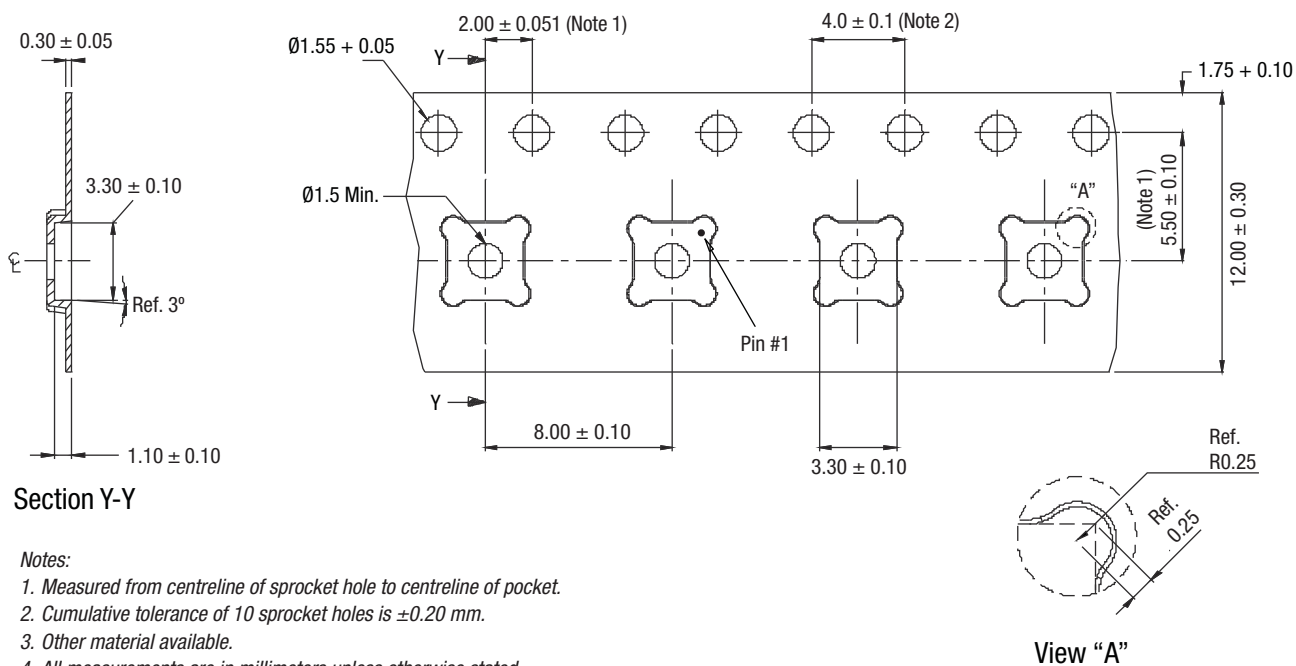

Section Y-Y

Notes:

1. Measured from centreline of sprocket hole to centreline of pocket.
2. Cumulative tolerance of 10 sprocket holes is ±0.20 mm.
3. Other material available.
4. All measurements are in millimeters unless otherwise stated.

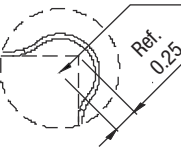

View "A"

ts019

Figure 8. SE2622L Tape and Reel Dimensions

Ordering Information

Model Name	Manufacturing Part Number	Evaluation Board Part Number
SE2622L 2.4 GHz, 256 QAM Power Amplifier	SE2622L	SE2622L-EK1

Copyright © 2013-2014 Skyworks Solutions, Inc. All Rights Reserved.

Information in this document is provided in connection with Skyworks Solutions, Inc. ("Skyworks") products or services. These materials, including the information contained herein, are provided by Skyworks as a service to its customers and may be used for informational purposes only by the customer. Skyworks assumes no responsibility for errors or omissions in these materials or the information contained herein. Skyworks may change its documentation, products, services, specifications or product descriptions at any time, without notice. Skyworks makes no commitment to update the materials or information and shall have no responsibility whatsoever for conflicts, incompatibilities, or other difficulties arising from any future changes.

No license, whether express, implied, by estoppel or otherwise, is granted to any intellectual property rights by this document. Skyworks assumes no liability for any materials, products or information provided hereunder, including the sale, distribution, reproduction or use of Skyworks products, information or materials, except as may be provided in Skyworks Terms and Conditions of Sale.

THE MATERIALS, PRODUCTS AND INFORMATION ARE PROVIDED "AS IS" WITHOUT WARRANTY OF ANY KIND, WHETHER EXPRESS, IMPLIED, STATUTORY, OR OTHERWISE, INCLUDING FITNESS FOR A PARTICULAR PURPOSE OR USE, MERCHANTABILITY, PERFORMANCE, QUALITY OR NON-INFRINGEMENT OF ANY INTELLECTUAL PROPERTY RIGHT; ALL SUCH WARRANTIES ARE HEREBY EXPRESSLY DISCLAIMED. SKYWORKS DOES NOT WARRANT THE ACCURACY OR COMPLETENESS OF THE INFORMATION, TEXT, GRAPHICS OR OTHER ITEMS CONTAINED WITHIN THESE MATERIALS. SKYWORKS SHALL NOT BE LIABLE FOR ANY DAMAGES, INCLUDING BUT NOT LIMITED TO ANY SPECIAL, INDIRECT, INCIDENTAL, STATUTORY, OR CONSEQUENTIAL DAMAGES, INCLUDING WITHOUT LIMITATION, LOST REVENUES OR LOST PROFITS THAT MAY RESULT FROM THE USE OF THE MATERIALS OR INFORMATION, WHETHER OR NOT THE RECIPIENT OF MATERIALS HAS BEEN ADVISED OF THE POSSIBILITY OF SUCH DAMAGE.

Skyworks products are not intended for use in medical, lifesaving or life-sustaining applications, or other equipment in which the failure of the Skyworks products could lead to personal injury, death, physical or environmental damage. Skyworks customers using or selling Skyworks products for use in such applications do so at their own risk and agree to fully indemnify Skyworks for any damages resulting from such improper use or sale.

Customers are responsible for their products and applications using Skyworks products, which may deviate from published specifications as a result of design defects, errors, or operation of products outside of published parameters or design specifications. Customers should include design and operating safeguards to minimize these and other risks. Skyworks assumes no liability for applications assistance, customer product design, or damage to any equipment resulting from the use of Skyworks products outside of stated published specifications or parameters.

Skyworks and the Skyworks symbol are trademarks or registered trademarks of Skyworks Solutions, Inc., in the United States and other countries. Third-party brands and names are for identification purposes only, and are the property of their respective owners. Additional information, including relevant terms and conditions, posted at www.skyworksinc.com, are incorporated by reference.

Компания «Life Electronics» занимается поставками электронных компонентов импортного и отечественного производства от производителей и со складов крупных дистрибьюторов Европы, Америки и Азии.

С конца 2013 года компания активно расширяет линейку поставок компонентов по направлению коаксиальный кабель, кварцевые генераторы и конденсаторы (керамические, пленочные, электролитические), за счёт заключения дистрибьюторских договоров

Мы предлагаем:

- Конкуренспособные цены и скидки постоянным клиентам.
- Специальные условия для постоянных клиентов.
- Подбор аналогов.
- Поставку компонентов в любых объемах, удовлетворяющих вашим потребностям.
- Приемлемые сроки поставки, возможна ускоренная поставка.
- Доставку товара в любую точку России и стран СНГ.
- Комплексную поставку.
- Работу по проектам и поставку образцов.
- Формирование склада под заказчика.
- Сертификаты соответствия на поставляемую продукцию (по желанию клиента).
- Тестирование поставляемой продукции.
- Поставку компонентов, требующих военную и космическую приемку.
- Входной контроль качества.
- Наличие сертификата ISO.

В составе нашей компании организован Конструкторский отдел, призванный помогать разработчикам, и инженерам.

Конструкторский отдел помогает осуществить:

- Регистрацию проекта у производителя компонентов.
- Техническую поддержку проекта.
- Защиту от снятия компонента с производства.
- Оценку стоимости проекта по компонентам.
- Изготовление тестовой платы монтаж и пусконаладочные работы.



Тел: +7 (812) 336 43 04 (многоканальный)

Email: org@lifeelectronics.ru