



Low Skew PCI / PCI-X Buffer

General Description

The ICS9112-27 is a high performance, low skew, low jitter PCI / PCI-X clock driver. It is designed to distribute high speed signals in PCI / PCI-X applications operating at speeds from 0 to 140 MHz.

The ICS9112-27 is characterized for operation from -40°C to 85°C for automotive and industrial applications.

Features

- Frequency range 0 - 140 MHz (3.3V)
- Less than 200 ps Jitter between outputs
- Skew controlled outputs < 100 ps
- Distribute one clock input to one bank of four outputs
- 3.3V ±10% operation
- Available in 8 pin TSSOP, and SOIC packages.

Block Diagram

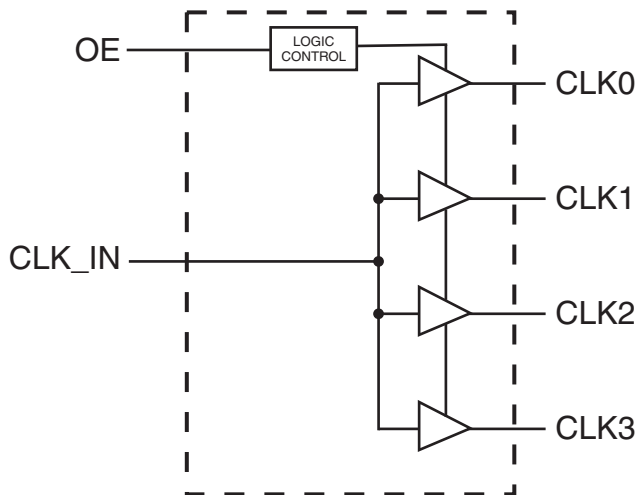

Pin Configuration

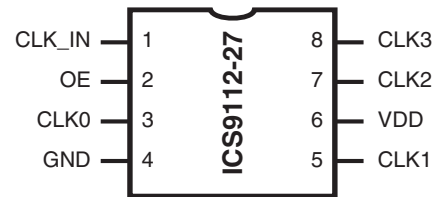

8 pin TSSOP & SOIC

Functionality Table

INPUTS		OUTPUTS
CLK_IN	OE	CLK(3:0)
0	0	Tristate
0	1	0
1	0	Tristate
1	1	1

Pin Descriptions

PIN NUMBER	PIN NAME	TYPE	DESCRIPTION
1	CLK_IN	IN	Input reference frequency.
2	OE	IN	Output enable. When OE is low, it tristates the clock outputs
3	CLK0	OUT	Buffered clock output
4	GND	PWR	Ground
5	CLK1	OUT	Buffered clock output
6	VDD	PWR	Power supply for 3.3V
7	CLK2	OUT	Buffered clock output
8	CLK3	OUT	Buffered clock output



Absolute Maximum Ratings

Supply voltage range V_{DD} -0.5V to 4.3 V
 Input voltage range V_I (see notes 1 & 2) -0.5V to $V_{DD} + 0.5V$
 Output voltage range V_O (see notes 1 & 2) -0.5V to $V_{DD} + 0.5V$
 Input clamp current I_{IK} ($V_I < 0$ or $V_I > V_{DD}$) ± 50 mA
 Output clamp current I_{OK} ($V_O < 0$ or $V_O > V_{DD}$) ± 50 mA
 Continuous total output current, I_O ($V_O = 0$ to V_{DD}) ± 50 mA
 Package thermal impedance θ_{JA} (see note 3): PW package 230.5°C/W
 Storage temperature range, T_{stg} -65°C to 150°C

Stresses above those listed under *Absolute Maximum Ratings* may cause permanent damage to the device. These ratings are stress specifications only and functional operation of the device at these or any other conditions above those listed in the operational sections of the specifications is not implied. Exposure to absolute maximum rating conditions for extended periods may affect product reliability.

Notes:

1. The input and output negative-voltage ratings may be exceeded if the input and output clamp-current ratings are observed.
2. This value is limited to 4.6 V maximum.
3. The package thermal impedance is calculated in accordance with JESD 51.

Recommended Operating Conditions

	Min	Nom	Max	Unit
Supply voltage, V_{DD}	3	3.3	3.6	V
High-level input voltage, V_{IH}	$0.7 \times V_{DD}$			V
Low-level input voltage, V_{IL}			$0.3 \times V_{DD}$	V
Input voltage, V_I	0		V_{DD}	V
High-level output current, I_{OH}			-24	mA
Low-level output current, I_{OL}			24	mA
Operating free-air temperature, T_A	-40		85	°C

Timing requirements over recommended ranges of supply voltage and operating free-air temperature

	Min	Nom	Max	Unit
Clock frequency f_{CLK}	0		140	MHz



Electrical Characteristics at 3.3V

T_A = -40° to 85°C; Supply Voltage V_{DD} = 3.3 V +/-10% (unless otherwise stated)

PARAMETER	SYMBOL	CONDITIONS	MIN	TYP	MAX	UNITS
Input voltage	V _{IK}	V _{DD} = 3.3V, I _I = -18 mA			-1.2	V
High-level Output Voltage	V _{OH}	V _{DD} = min to max, I _{OH} = -1 mA	V _{DD} - 0.2	3.3		V
		V _{DD} = 3V, I _{OH} = -24 mA	2	2.3		
		V _{DD} = 3V, I _{OH} = 12 mA	2.4	2.7		
Low-level Output Voltage	V _{OL}	V _{DD} = min to max, I _{OH} = 1 mA		0.022	0.2	V
		V _{DD} = 3V, I _{OH} = 24 mA		0.61	0.8	
		V _{DD} = 3V, I _{OH} = 12 mA		0.31	0.55	
High-level Input Current	I _{OH}	V _{DD} = 3V, V _O = 1V		-53	-40	mA
		V _{DD} = 3.3V, V _O = 1.65V		-54		
Low-level Input Current	I _{OL}	V _{DD} = 3V, V _O = 2V	40	53		mA
		V _{DD} = 3.3V, V _O = 1.65V		57		
Input Current	I _I	V = V _O or V _{DD}	-5		5	mA
Dynamic Supply Current	I _{DD}	Unloaded outputs at 66.67 MHz		13	37	mA
Input Capacitance ¹	C _I	V _{DD} = 3.3V, V _I = 0V or 3.3V		3		pF
Output Capacitance ¹	C _O	V _{DD} = 3.3V, V _I = 0V or 3.3V		3.2		pF

1. Guaranteed by design, not 100% tested in production.

Switching Characteristics at 3.3V

T_A = -40° to 0 85°C; Supply Voltage V_{DD} = 3.3 V +/-10% (For loading, see figures 1 and 2)

PARAMETER	SYMBOL	CONDITIONS	MIN	TYP	MAX	UNITS
High-to-low Propagation Delay ¹	t _{PLH}	V _O = V _{DD} /2	1.8	3.1	3.8	ns
Low-to-high Propagation Delay ¹	t _{PHL}	V _O = V _{DD} /2	1.8	2.9	3.8	ns
Output Skew Window ¹	T _{sk(o)}	V _O = V _{DD} /2		50	100	ps
Pulse Skew = t _{PLH} - t _{PHL} ¹	T _{sk(p)}	V _O = V _{DD} /2			300	ps
Process Skew ¹	T _{sk(pr)}	V _O = V _{DD} /2			500	ps
CLKIN High Time ¹	T _{high}	66 MHz	6			ns
		140 MHz	3			
CLKIN Low Time ¹	T _{low}	66 MHz	6			ns
		140 MHz	3			
Output Rise Slew Rate ¹	T _r	0.3 to 0.6 V _{DD}	1.5	2.1	4	V/ns
Output Rise Slew Rate ¹	T _f	0.6 to 0.3 V _{DD}	1.5	2.4	4	V/ns

1. Guaranteed by design, not 100% tested in production.



Parameter Measurement Information

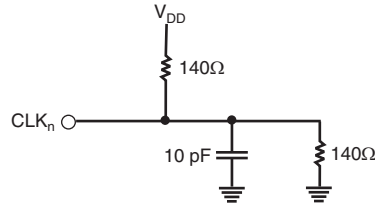

Figure 1. Test Load Circuit

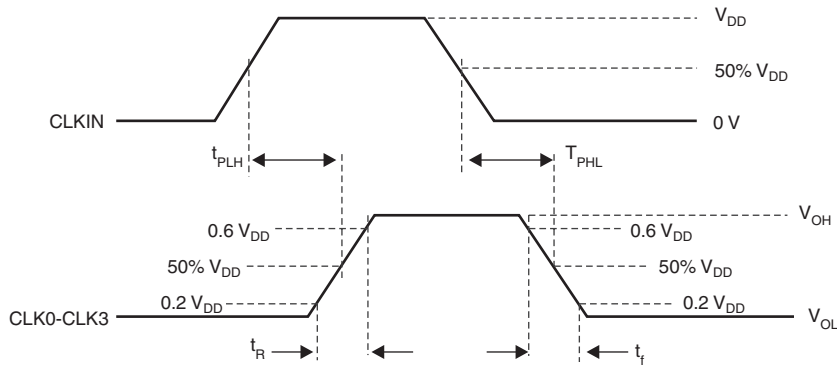

Figure 2. Voltage Thresholds for Propagation Delay (t_{pd}) Measurements

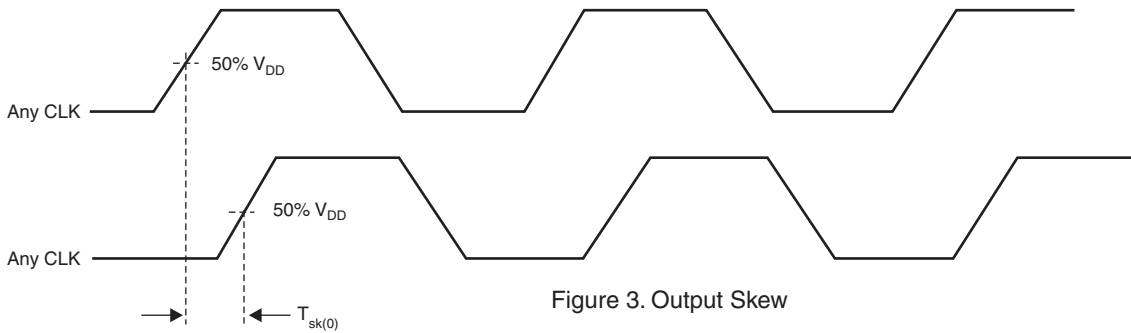

Figure 3. Output Skew

Parameter	Value	Unit
$V_{IH(Min)}$	$0.5 V_{DD}$	V
$V_{IL(Max)}$	$0.35 V_{DD}$	V
V_{test}	$0.4 V_{DD}$	V

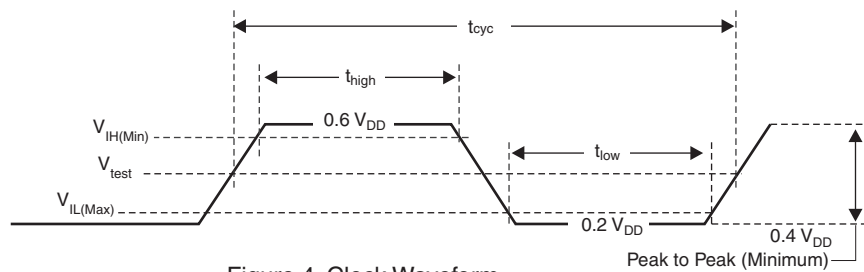
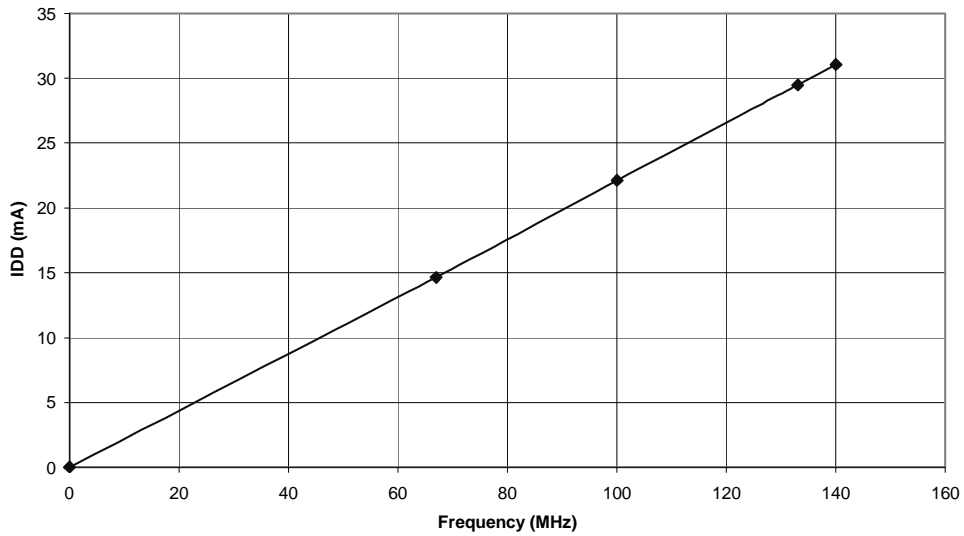

Figure 4. Clock Waveform

Note: All parameters in Figure 4 are according to PCI-X 1.0 specifications.



ICS9112AG-27
SUPPLY CURRENT
vs.
FREQUENCY
 $V_{DD} = 3.63\text{ V}$, $T_A = 85^\circ\text{C}$



ICS9112AG-27
HIGH-LEVEL OUTPUT VOLTAGE
vs
HIGH-LEVEL OUTPUT CURRENT
 $V_{DD} = 3.3\text{V}$, $T_A = 25^\circ\text{C}$

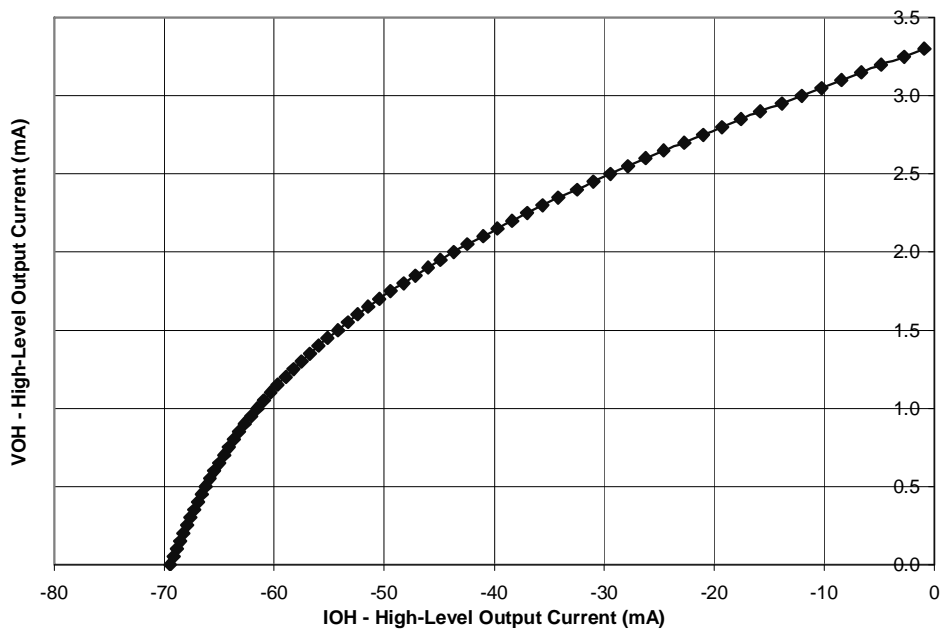



ICS9112AG-27
LOW-LEVEL OUTPUT VOLTAGE
vs
LOW-LEVEL OUTPUT CURRENT
 $V_{DD} = 3.3V, T_A = 25^{\circ}C$

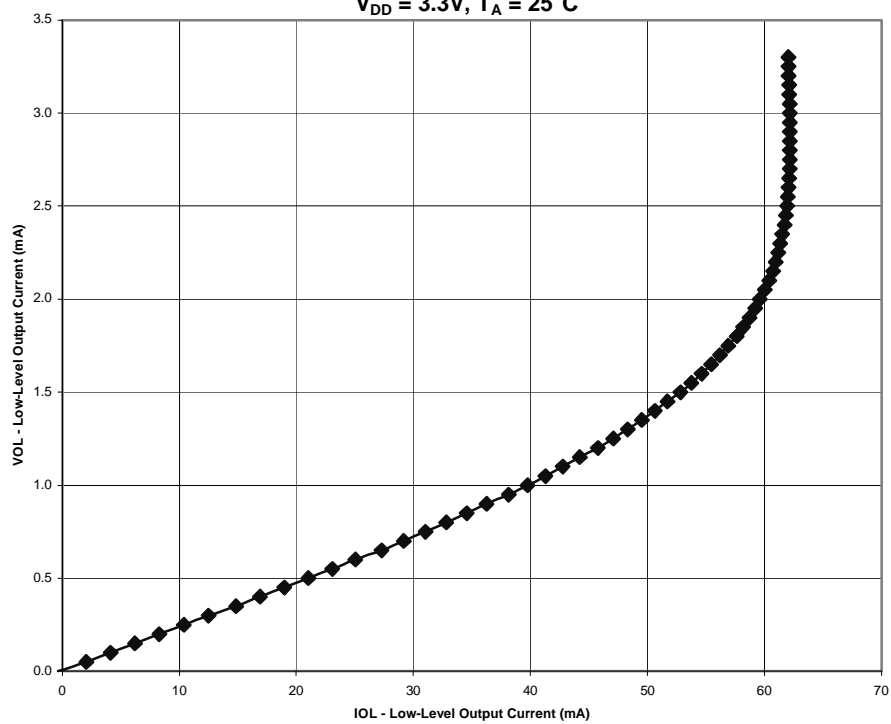

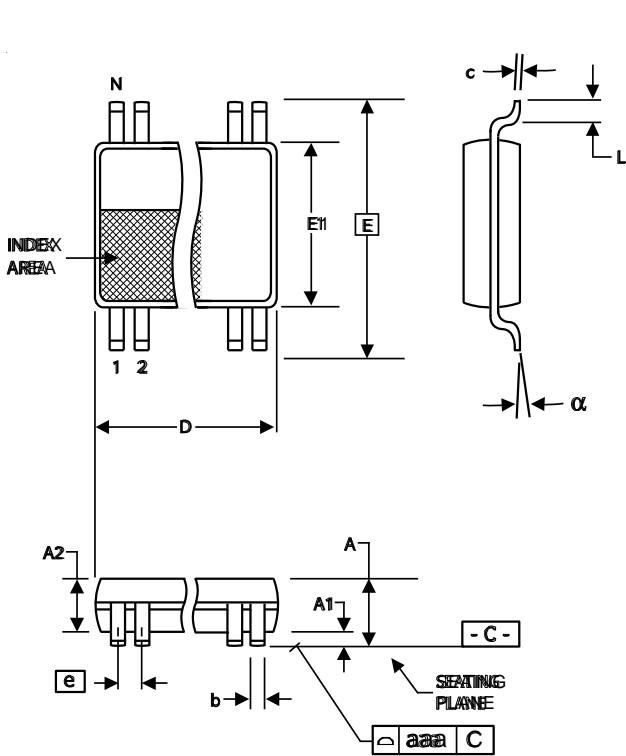

4.40 mm. Body, 0.65 mm. Pitch TSSOP
(173 mil) (25.6 mil)

SYMBOL	In Millimeters COMMON DIMENSIONS		In Inches COMMON DIMENSIONS	
	MIN	MAX	MIN	MAX
A	--	1.20	--	.047
A1	0.05	0.15	.002	.006
A2	0.80	1.05	.032	.041
b	0.19	0.30	.007	.012
c	0.09	0.20	.0035	.008
D	SEE VARIATIONS		SEE VARIATIONS	
E	6.40 BASIC		0.252 BASIC	
E1	4.30	4.50	.169	.177
e	0.65 BASIC		0.0256 BASIC	
L	0.45	0.75	.018	.030
N	SEE VARIATIONS		SEE VARIATIONS	
α	0°	8°	0°	8°
aaa	--	0.10	--	.004

VARIATIONS

N	D mm.		D (inch)	
	MIN	MAX	MIN	MAX
8	2.90	3.10	.114	.122

Reference Doc.: JEDEC Publication 95, MO-153
10-0035

4.40 mm. Body, 0.65 mm. pitch TSSOP
(173 mil) (0.0256 Inch)

Ordering Information

9112AG-27LFT

Example:

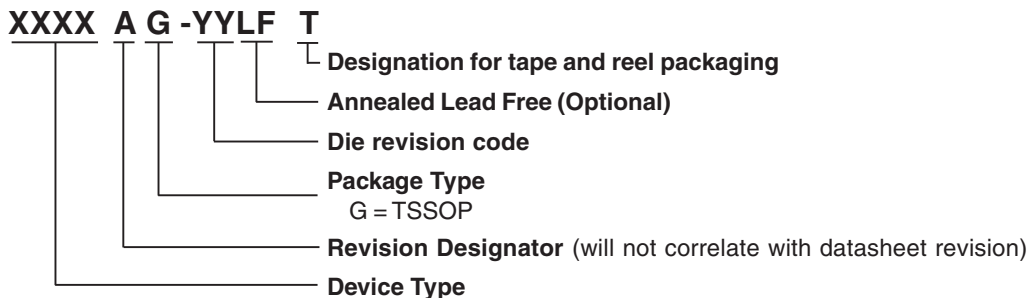

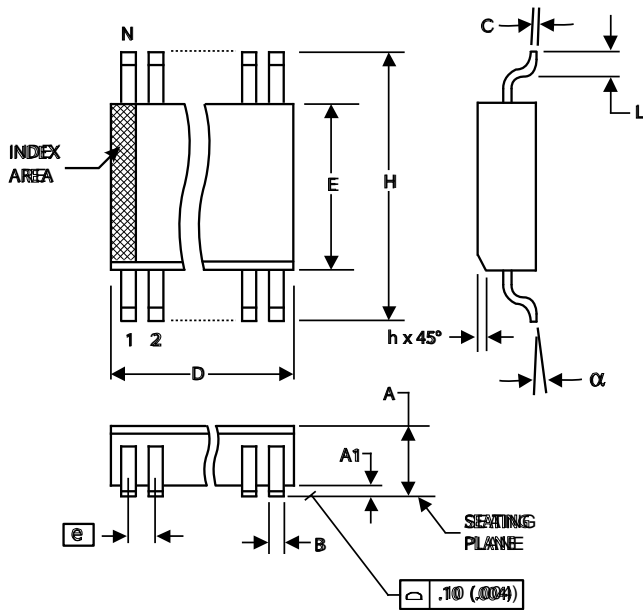

150 mil (Narrow Body) SOIC

150 mil (Narrow Body) SOIC

SYMBOL	In Millimeters		In Inches	
	MIN	MAX	MIN	MAX
A	1.35	1.75	.0532	.0688
A1	0.10	0.25	.0040	.0098
B	0.33	0.51	.013	.020
C	0.19	0.25	.0075	.0098
D	SEE VARIATIONS		SEE VARIATIONS	
E	3.80	4.00	.1497	.1574
e	1.27 BASIC		0.050 BASIC	
H	5.80	6.20	.2284	.2440
h	0.25	0.50	.010	.020
L	0.40	1.27	.016	.050
N	SEE VARIATIONS		SEE VARIATIONS	
α	0°	8°	0°	8°

VARIATIONS

N	D mm.		D (inch)	
	MIN	MAX	MIN	MAX
8	4.80	5.00	.1890	.1968

Reference Doc.: JEDEC Publication 95, MS-012
10-0030

Ordering Information

9112AM-27LFT

Example:

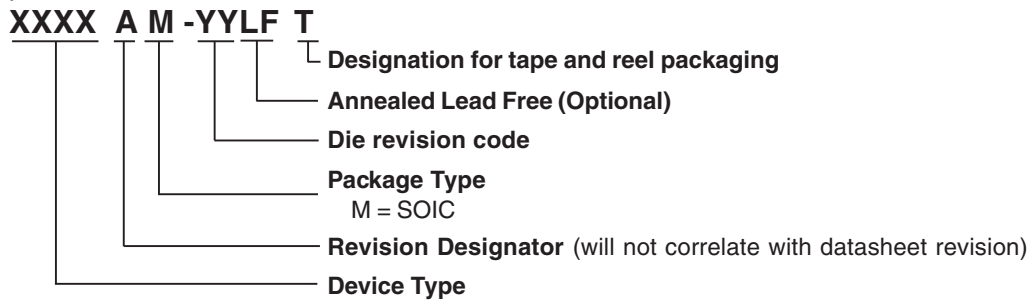

Компания «Life Electronics» занимается поставками электронных компонентов импортного и отечественного производства от производителей и со складов крупных дистрибьюторов Европы, Америки и Азии.

С конца 2013 года компания активно расширяет линейку поставок компонентов по направлению коаксиальный кабель, кварцевые генераторы и конденсаторы (керамические, пленочные, электролитические), за счёт заключения дистрибьюторских договоров

Мы предлагаем:

- Конкурентоспособные цены и скидки постоянным клиентам.
- Специальные условия для постоянных клиентов.
- Подбор аналогов.
- Поставку компонентов в любых объемах, удовлетворяющих вашим потребностям.
- Приемлемые сроки поставки, возможна ускоренная поставка.
- Доставку товара в любую точку России и стран СНГ.
- Комплексную поставку.
- Работу по проектам и поставку образцов.
- Формирование склада под заказчика.
- Сертификаты соответствия на поставляемую продукцию (по желанию клиента).
- Тестирование поставляемой продукции.
- Поставку компонентов, требующих военную и космическую приемку.
- Входной контроль качества.
- Наличие сертификата ISO.

В составе нашей компании организован Конструкторский отдел, призванный помогать разработчикам, и инженерам.

Конструкторский отдел помогает осуществить:

- Регистрацию проекта у производителя компонентов.
- Техническую поддержку проекта.
- Защиту от снятия компонента с производства.
- Оценку стоимости проекта по компонентам.
- Изготовление тестовой платы монтаж и пусконаладочные работы.



Тел: +7 (812) 336 43 04 (многоканальный)

Email: org@lifeelectronics.ru