

# KAI-04070

## 2048 (H) x 2048 (V) Interline CCD Image Sensor

### Description

The KAI-04070 Image Sensor is a 4-megapixel CCD in a 4/3 inch optical format. Based on the TRUESENSE 7.4 micron Interline Transfer CCD Platform, the sensor provides very high smear rejection and up to 82 dB linear dynamic range through the use of a unique dual-gain amplifier. A flexible readout architecture enables use of 1, 2, or 4 outputs for full resolution readout up to 28 frames per second, while a vertical overflow drain structure suppresses image blooming and enables electronic shuttering for precise exposure control.

**Table 1. GENERAL SPECIFICATIONS**

| Parameter  | Typical Value  |
|--|--|
| Architecture   | Interline CCD, Progressive Scan  |
| Total Number of Pixels   | 2128 (H) × 2112 (V)  |
| Number of Effective Pixels   | 2080 (H) × 2080 (V)  |
| Number of Active Pixels  | 2048 (H) × 2048 (V)  |
| Pixel Size   | 7.4 μm (H) × 7.4 μm (V)  |
| Active Image Size  | 15.2 mm (H) × 15.2 mm (V),<br>21.4 mm (Diagonal),<br>4/3" Optical Format |
| Aspect Ratio   | 1:1  |
| Number of Outputs  | 1, 2, or 4   |
| Charge Capacity  | 44,000 electrons   |
| Output Sensitivity   | 8.7 μV/e <sup>-</sup> (Low), 33 μV/e <sup>-</sup> (High)                 |
| Quantum Efficiency<br>Pan (-ABA, -PBA, -QBA)<br>R, G, B (-CBA)<br>R, G, B (-FBA) | 52%<br>38%, 42%, 43%<br>37%, 42%, 41%                                    |
| Read Noise (f = 40 MHz)  | 12 e <sup>-</sup> rms  |
| Dark Current<br>Photodiode<br>VCCD   | 3 e <sup>-</sup> /s<br>145 e <sup>-</sup> /s                             |
| Dark Current Doubling Temp.<br>Photodiode<br>VCCD                                | 7°C<br>9°C   |
| Dynamic Range<br>High Gain Amp (40 MHz)<br>Dual Amp, 2×2 Bin (40 MHz)            | 70 dB<br>82 dB   |
| Charge Transfer Efficiency   | 0.999999   |
| Blooming Suppression   | > 1000 X   |
| Smear  | -115 dB  |
| Image Lag  | < 10 electrons   |
| Maximum Pixel Clock Speed  | 40 MHz   |
| Maximum Frame Rate<br>Quad Output<br>Dual Output<br>Single Output                | 28 fps<br>14 fps<br>8 fps  |
| Package  | 68 Pin PGA   |
| Cover Glass  | AR Coated, 2 Sides   |

NOTE: All Parameters are specified at T = 40°C unless otherwise noted.



**ON Semiconductor®**

[www.onsemi.com](http://www.onsemi.com)

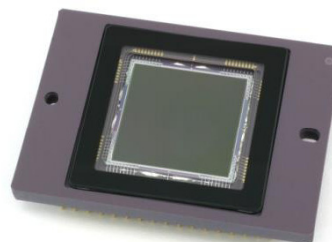

**Figure 1. KAI-04070 Interline CCD Image Sensor**

### Features

- Superior Smear Rejection
- Up to 82 dB Linear Dynamic Range
- Bayer Color Pattern, TRUESENSE Sparse Color Filter Pattern, and Monochrome Configurations
- Progressive Scan & Flexible Readout Architecture
- High Frame Rate
- High Sensitivity – Low Noise Architecture
- Package Pin Reserved for Device Identification

### Application

- Industrial Imaging and Inspection
- Traffic
- Surveillance

### ORDERING INFORMATION

See detailed ordering and shipping information on page 2 of this data sheet.

## KAI-04070

The sensor is available with the TRUESENSE Sparse Color Filter Pattern, a technology which provides a 2x improvement in light sensitivity compared to a standard color Bayer part.

The sensor shares common pin-out and electrical configurations with a full family of Truesense Imaging

Interline Transfer CCD image sensors, allowing a single camera design to be leveraged in support of multiple devices.

### ORDERING INFORMATION

**Table 2. ORDERING INFORMATION – KAI-04070 IMAGE SENSOR**

| Part Number            | Description   | Marking Code                   |
|------------------------|---|--------------------------------|
| KAI-04070-ABA-JD-BA    | Monochrome, Telecentric Microlens, PGA Package, Sealed Clear Cover Glass with AR Coating (Both Sides), Standard Grade                           | KAI-04070-ABA<br>Serial Number |
| KAI-04070-ABA-JD-AE    | Monochrome, Telecentric Microlens, PGA Package, Sealed Clear Cover Glass with AR Coating (Both Sides), Engineering Grade                        |                                |
| KAI-04070-ABA-JR-BA    | Monochrome, Telecentric Microlens, PGA Package, Taped Clear Cover Glass with AR Coating (Both Sides), Standard Grade                            |                                |
| KAI-04070-ABA-JR-AE    | Monochrome, Telecentric Microlens, PGA Package, Taped Clear Cover Glass with AR Coating (Both Sides), Engineering Grade                         |                                |
| 11KAI-04070-FBA-JD-BA  | Gen2 Color (Bayer RGB), Telecentric Microlens, PGA Package, Sealed Clear Cover Glass with AR Coating (Both Sides), Standard Grade               | KAI-04070-FBA<br>Serial Number |
| 11KAI-04070-FBA-JD-AE  | Gen2 Color (Bayer RGB), Telecentric Microlens, PGA Package, Sealed Clear Cover Glass with AR Coating (Both Sides), Engineering Grade            |                                |
| 11KAI-04070-QBA-JD-BA  | Gen2 Color (TRUESENSE Sparse CFA), Telecentric Microlens, PGA Package, Sealed Clear Cover Glass with AR Coating (Both Sides), Standard Grade    | KAI-04070-QBA<br>Serial Number |
| 11KAI-04070-QBA-JD-AE  | Gen2 Color (TRUESENSE Sparse CFA), Telecentric Microlens, PGA Package, Sealed Clear Cover Glass with AR Coating (Both Sides), Engineering Grade |                                |
| 11KAI-04070-CBA-JD-BA* | Gen1 Color (Bayer RGB), Telecentric Microlens, PGA Package, Sealed Clear Cover Glass with AR Coating (Both Sides), Standard Grade               | KAI-04070-CBA<br>Serial Number |
| 11KAI-04070-CBA-JD-AE* | Gen1 Color (Bayer RGB), Telecentric Microlens, PGA Package, Sealed Clear Cover Glass with AR Coating (Both Sides), Engineering Grade            |                                |
| 11KAI-04070-PBA-JD-BA* | Gen1 Color (TRUESENSE Sparse CFA), Telecentric Microlens, PGA Package, Sealed Clear Cover Glass with AR Coating (Both Sides), Standard Grade    | KAI-04070-PBA<br>Serial Number |
| 11KAI-04070-PBA-JD-AE* | Gen1 Color (TRUESENSE Sparse CFA), Telecentric Microlens, PGA Package, Sealed Clear Cover Glass with AR Coating (Both Sides), Engineering Grade |                                |

\*Note recommended for new designs.

**Table 3. ORDERING INFORMATION – EVALUATION SUPPORT**

| Part Number                   | Description  |
|-------------------------------|--|
| G2-FPGA-BD-14-40-A-GEVK       | FPGA Board for IT-CCD Evaluation Hardware          |
| KAI-68PIN-HEAD-BD-A-GEVB      | 68 Pin Imager Board for IT-CCD Evaluation Hardware |
| LENS-MOUNT-KIT-A-GEVK         | Lens Mount Kit for IT-CCD Evaluation Hardware      |
| KAI-68PIN-N-PROBE-CARD-A-GEVB | 68 Pin Probe Card (Narrow Socket)                  |
| KAI-68PIN-W-PROBE-CARD-A-GEVB | 68 Pin Probe Card (Wide Socket)                    |

See the ON Semiconductor *Device Nomenclature* document (TND310/D) for a full description of the naming convention used for image sensors. For reference documentation, including information on evaluation kits, please visit our web site at [www.onsemi.com](http://www.onsemi.com).

DEVICE DESCRIPTION

Architecture

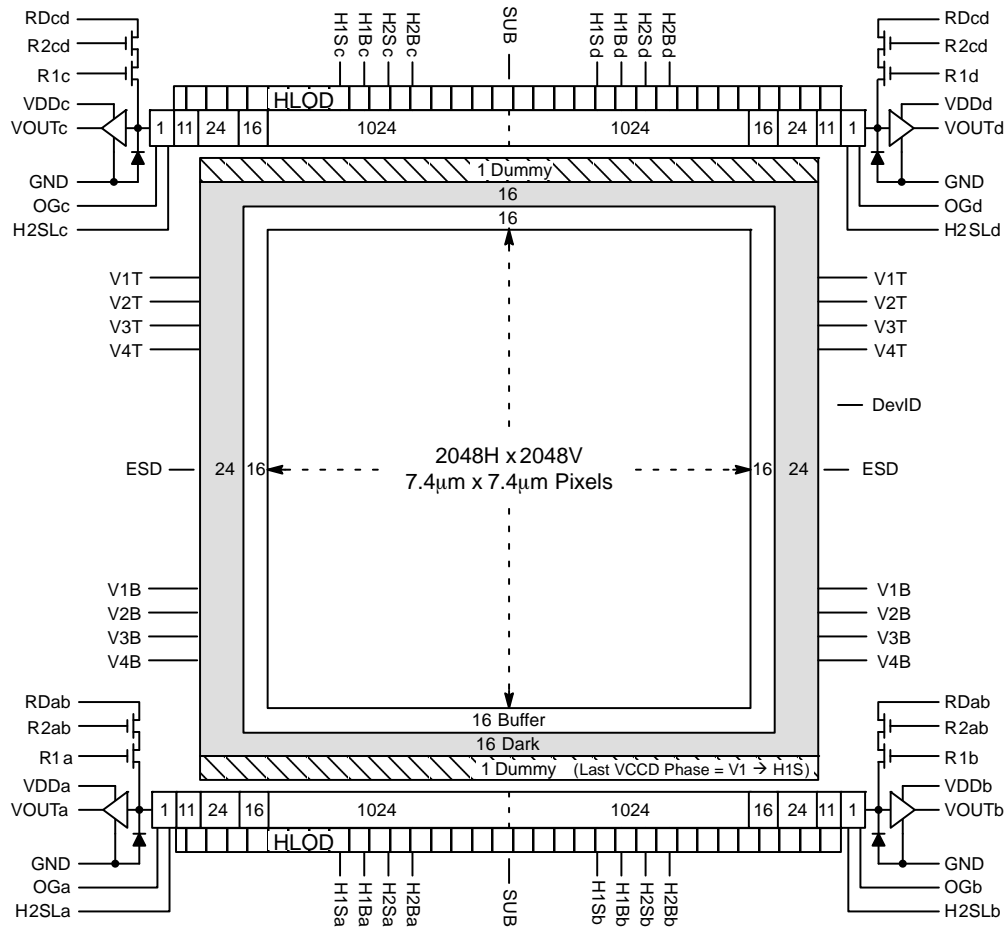

Figure 2. Block Diagram

**Dark Reference Pixels**

There are 16 dark reference rows at the top and 16 dark rows at the bottom of the image sensor. The 24 dark columns on the left or right side of the image sensor should be used as a dark reference.

Under normal circumstances use only the center 22 columns of the 24 column dark reference due to potential light leakage.

**Dummy Pixels**

Within each horizontal shift register there are 12 leading additional shift phases. These pixels are designated as dummy pixels and should not be used to determine a dark reference level.

In addition, there is one dummy row of pixels at the top and bottom of the image.

**Active Buffer Pixels**

16 unshielded pixels adjacent to any leading or trailing dark reference regions are classified as active buffer pixels. These pixels are light sensitive but are not tested for defects and non-uniformities.

**Image Acquisition**

An electronic representation of an image is formed when incident photons falling on the sensor plane create electron-hole pairs within the individual silicon photodiodes. These photoelectrons are collected locally by the formation of potential wells at each photosite. Below photodiode saturation, the number of photoelectrons collected at each pixel is linearly dependent upon light level and exposure time and non-linearly dependent on wavelength. When the photodiodes charge capacity is reached, excess electrons are discharged into the substrate to prevent blooming.

**ESD Protection**

Adherence to the power-up and power-down sequence is critical. Failure to follow the proper power-up and power-down sequences may cause damage to the sensor. See Power-Up and Power-Down Sequence section.

## Bayer Color Filter Pattern

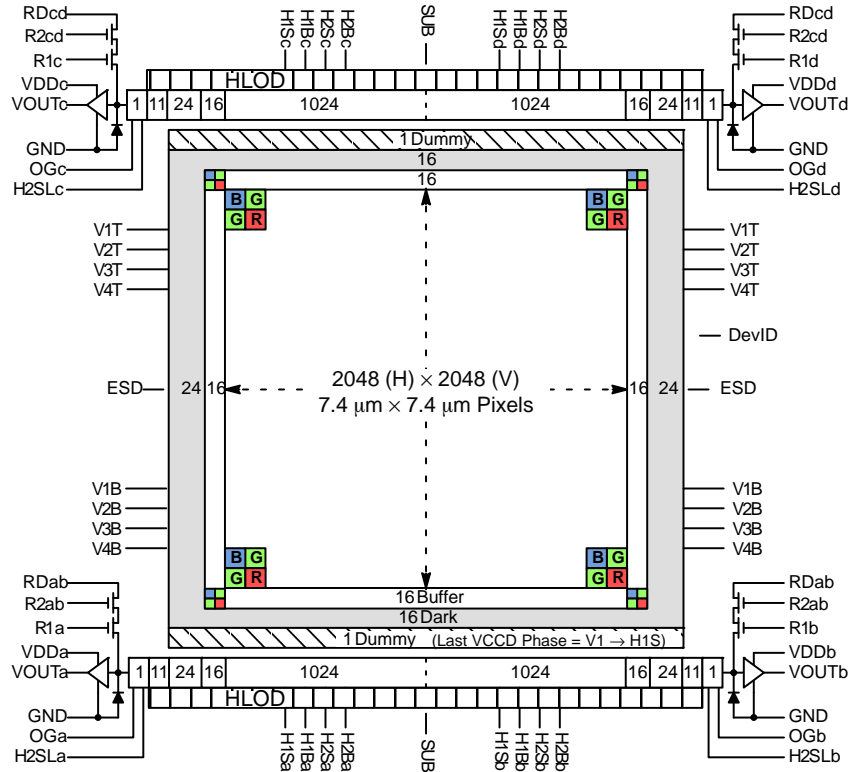

Figure 3. Bayer Color Filter Pattern

## TRUESENSE Sparse Color Filter Pattern

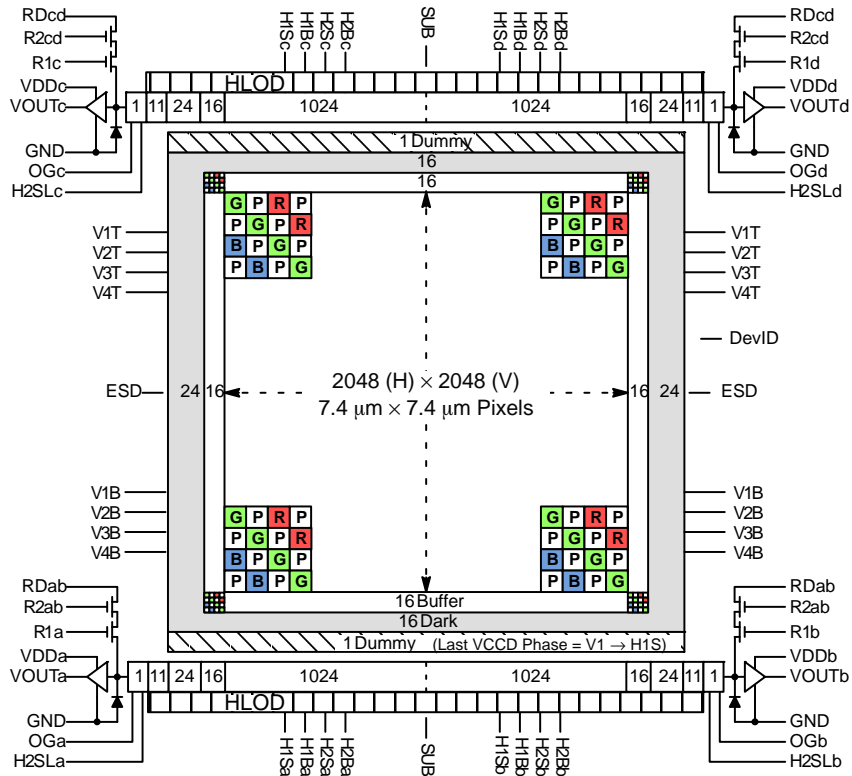

Figure 4. TRUESENSE Sparse Color Filter Pattern

Physical Description

Pin Description and Device Orientation

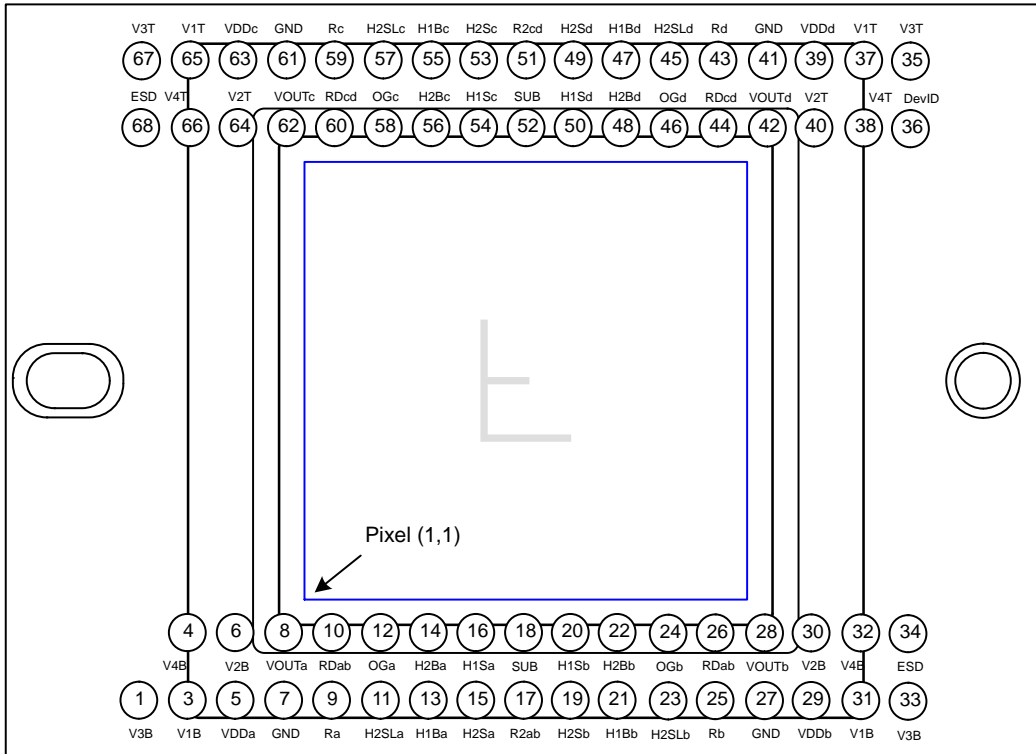

Figure 5. Package Pin Designations – Top View

Table 4. PACKAGE PIN DESCRIPTION

| Pin | Name  | Description  |
|-----|-------|--|
| 1   | V3B   | Vertical CCD Clock, Phase 3, Bottom                            |
| 3   | V1B   | Vertical CCD Clock, Phase 1, Bottom                            |
| 4   | V4B   | Vertical CCD Clock, Phase 4, Bottom                            |
| 5   | VDDa  | Output Amplifier Supply, Quadrant a                            |
| 6   | V2B   | Vertical CCD Clock, Phase 2, Bottom                            |
| 7   | GND   | Ground   |
| 8   | VOUta | Video Output, Quadrant a                                       |
| 9   | Ra    | Reset Gate, Standard (High) Gain, Quadrant a                   |
| 10  | RDab  | Reset Drain, Quadrants a & b                                   |
| 11  | H2SLa | Horizontal CCD Clock, Phase 2, Storage, Last Phase, Quadrant a |
| 12  | OGa   | Output Gate, Quadrant a  |
| 13  | H1Ba  | Horizontal CCD Clock, Phase 1, Barrier, Quadrant a             |
| 14  | H2Ba  | Horizontal CCD Clock, Phase 2, Barrier, Quadrant a             |
| 15  | H2Sa  | Horizontal CCD Clock, Phase 2, Storage, Quadrant a             |
| 16  | H1Sa  | Horizontal CCD Clock, Phase 1, Storage, Quadrant a             |
| 17  | R2ab  | Reset Gate, Low Gain, Quadrants a & b                          |
| 18  | SUB   | Substrate  |
| 19  | H2Sb  | Horizontal CCD Clock, Phase 2, Storage, Quadrant b             |
| 20  | H1Sb  | Horizontal CCD Clock, Phase 1, Storage, Quadrant b             |
| 21  | H1Bb  | Horizontal CCD Clock, Phase 1, Barrier, Quadrant b             |

**Table 4. PACKAGE PIN DESCRIPTION** (continued)

| Pin | Name  | Description  |
|-----|-------|--|
| 22  | H2Bb  | Horizontal CCD Clock, Phase 2, Barrier, Quadrant b             |
| 23  | H2SLb | Horizontal CCD Clock, Phase 1, Storage, Last Phase, Quadrant b |
| 24  | OGb   | Output Gate, Quadrant b  |
| 25  | Rb    | Reset Gate, Standard (High) Gain, Quadrant b                   |
| 26  | RDab  | Reset Drain, Quadrants a & b                                   |
| 27  | GND   | Ground   |
| 28  | VOUtb | Video Output, Quadrant b                                       |
| 29  | VDDb  | Output Amplifier Supply, Quadrant b                            |
| 30  | V2B   | Vertical CCD Clock, Phase 2, Bottom                            |
| 31  | V1B   | Vertical CCD Clock, Phase 1, Bottom                            |
| 32  | V4B   | Vertical CCD Clock, Phase 4, Bottom                            |
| 33  | V3B   | Vertical CCD Clock, Phase 3, Bottom                            |
| 34  | ESD   | ESD Protection Disable   |
| 35  | V3T   | Vertical CCD Clock, Phase 3, Top                               |
| 36  | DevID | Device Identification  |
| 37  | V1T   | Vertical CCD Clock, Phase 1, Top                               |
| 38  | V4T   | Vertical CCD Clock, Phase 4, Top                               |
| 39  | VDDd  | Output Amplifier Supply, Quadrant d                            |
| 40  | V2T   | Vertical CCD Clock, Phase 2, Top                               |
| 41  | GND   | Ground   |
| 42  | VOUtd | Video Output, Quadrant d                                       |
| 43  | Rd    | Reset Gate, Standard (High) Gain, Quadrant d                   |
| 44  | RDcd  | Reset Drain, Quadrants c & d                                   |
| 45  | H2SLd | Horizontal CCD Clock, Phase 2, Storage, Last Phase, Quadrant d |
| 46  | OGd   | Output Gate, Quadrant d  |
| 47  | H1Bd  | Horizontal CCD Clock, Phase 1, Barrier, Quadrant d             |
| 48  | H2Bd  | Horizontal CCD Clock, Phase 2, Barrier, Quadrant d             |
| 49  | H2Sd  | Horizontal CCD Clock, Phase 2, Storage, Quadrant d             |
| 50  | H1Sd  | Horizontal CCD Clock, Phase 1, Storage, Quadrant d             |
| 51  | R2cd  | Reset Gate, Low Gain, Quadrants c & d                          |
| 52  | SUB   | Substrate  |
| 53  | H2Sc  | Horizontal CCD Clock, Phase 2, Storage, Quadrant c             |
| 54  | H1Sc  | Horizontal CCD Clock, Phase 1, Storage, Quadrant c             |
| 55  | H1Bc  | Horizontal CCD Clock, Phase 1, Barrier, Quadrant c             |
| 56  | H2Bc  | Horizontal CCD Clock, Phase 2, Barrier, Quadrant c             |
| 57  | H2SLc | Horizontal CCD Clock, Phase 2, Storage, Last Phase, Quadrant c |
| 58  | OGc   | Output Gate, Quadrant c  |
| 59  | Rc    | Reset Gate, Standard (High) Gain, Quadrant c                   |
| 60  | RDcd  | Reset Drain, Quadrants c & d                                   |
| 61  | GND   | Ground   |
| 62  | VOUtc | Video Output, Quadrant c                                       |
| 63  | VDDc  | Output Amplifier Supply, Quadrant c                            |
| 64  | V2T   | Vertical CCD Clock, Phase 2, Top                               |
| 65  | V1T   | Vertical CCD Clock, Phase 1, Top                               |
| 66  | V4T   | Vertical CCD Clock, Phase 4, Top                               |
| 67  | V3T   | Vertical CCD Clock, Phase 3, Top                               |
| 68  | ESD   | EDS Protection Disable   |

1. Liked named pins are internally connected and should have a common drive signal.

## IMAGING PERFORMANCE

**Table 5. TYPICAL OPERATIONAL CONDITIONS**

(Unless otherwise noted, the Imaging Performance Specifications are measured using the following conditions.)

| Description  | Condition                                       | Notes |
|--------------|---|-------|
| Light Source | Continuous Red, Green and Blue LED Illumination | 1     |
| Operation    | Nominal Operating Voltages and Timing           |       |

1. For monochrome sensor, only green LED used.

## Specifications

**Table 6. PERFORMANCE SPECIFICATIONS**

| Description   | Symbol                     | Min.        | Nom.        | Max.        | Unit               | Sampling Plan | Temperature Tested at (°C) |
|---|----------------------------|-------------|-------------|-------------|--------------------|---------------|----------------------------|
| <b>ALL CONFIGURATIONS</b>   |                            |             |             |             |                    |               |                            |
| Dark Field Global Non-Uniformity  | DSNU                       | –           | –           | 2.0         | mVpp               | Die           | 27, 40                     |
| Bright Field Global Non-Uniformity (Note 1)   |                            | –           | 2.0         | 5.0         | % rms              | Die           | 27, 40                     |
| Bright Field Global Peak to Peak Non-Uniformity (Note 1)  | PRNU                       | –           | 5.0         | 15.0        | % pp               | Die           | 27, 40                     |
| Bright Field Center Non-Uniformity (Note 1)   |                            | –           | 1.0         | 2.0         | % rms              | Die           | 27, 40                     |
| Maximum Photoresponse Non-Linearity<br>High Gain (4,000 to 20,000 electrons)<br>High Gain (4,000 to 40,000 electrons)<br>Low Gain (8,000 to 80,000 electrons) | NL_HG1<br>NL_HG2<br>NL_LG1 | –<br>–<br>– | 2<br>3<br>6 | –<br>–<br>– | %                  | Design        |                            |
| Maximum Gain Difference between Outputs (Note 2)  | $\Delta G$                 | –           | –           | 10          | %                  | Design        |                            |
| Horizontal CCD Charge Capacity  | H <sub>Ne</sub>            | –           | 90          | –           | ke <sup>-</sup>    | Design        |                            |
| Vertical CCD Charge Capacity  | V <sub>Ne</sub>            | –           | 60          | –           | ke <sup>-</sup>    | Design        |                            |
| Photodiode Charge Capacity (Note 3)   | P <sub>Ne</sub>            | –           | 44          | –           | ke <sup>-</sup>    | Die           | 27, 40                     |
| Floating Diffusion Capacity – High Gain   | FNe_HG                     | 40          | –           | –           | ke <sup>-</sup>    | Die           | 27, 40                     |
| Floating Diffusion Capacity – Low Gain  | FNe_LG                     | 160         | –           | –           | ke <sup>-</sup>    | Die           | 27, 40                     |
| Horizontal CCD Charge Transfer Efficiency   | HCTE                       | 0.999995    | 0.999999    | –           |                    | Die           |                            |
| Vertical CCD Charge Transfer Efficiency   | VCTE                       | 0.999995    | 0.999999    | –           |                    | Die           |                            |
| Photodiode Dark Current   | I <sub>PD</sub>            | –           | 7           | 70          | e/p/s              | Die           | 40                         |
| Vertical CCD Dark Current   | I <sub>VD</sub>            | –           | 140         | 400         | e/p/s              | Die           | 40                         |
| Image Lag   | Lag                        | –           | –           | 10          | e <sup>-</sup>     | Design        |                            |
| Anti-Blooming Factor  | X <sub>AB</sub>            | 1,000       | –           | –           |                    | Design        |                            |
| Vertical Smear  | Smr                        | –           | -115        | –           | dB                 | Design        |                            |
| Read Noise (Note 4)<br>High Gain<br>Low Gain  | n <sub>e-T</sub>           | –           | 12<br>45    | –           | e <sup>-</sup> rms | Design        |                            |
| Dynamic Range, Standard (Notes 4, 5)  | DR                         | –           | 70.5        | –           | dB                 | Design        |                            |
| Dynamic Range, Extended Linear Dynamic Range Mode (XLDR) (Notes 4, 5)   | XLDR                       | –           | 82.5        | –           | dB                 | Design        |                            |
| Output Amplifier DC Offset  | V <sub>ODC</sub>           | –           | 9.0         | –           | V                  | Die           | 27, 40                     |
| Output Amplifier Bandwidth (Note 6)   | f <sub>-3db</sub>          | –           | 250         | –           | MHz                | Die           |                            |
| Output Amplifier Impedance  | R <sub>OUT</sub>           | –           | 127         | –           | Ω                  | Die           | 27, 40                     |
| Output Amplifier Sensitivity<br>High Gain<br>Low Gain   | $\Delta V/\Delta N$        | –<br>–      | 33<br>8.7   | –<br>–      | μV/e <sup>-</sup>  | Design        |                            |

Table 6. PERFORMANCE SPECIFICATIONS (continued)

| Description   | Symbol            | Min.        | Nom.              | Max.        | Unit | Sampling Plan | Temperature Tested at (°C) |
|---|-------------------|-------------|-------------------|-------------|------|---------------|----------------------------|
| <b>KAI-04070-ABA AND KAI-04070-PBA AND KAI-04070-QBA CONFIGURATIONS</b>   |                   |             |                   |             |      |               |                            |
| Peak Quantum Efficiency   | QE <sub>MAX</sub> | -           | 52                | -           | %    | Design        |                            |
| Peak Quantum Efficiency Wavelength  | λ <sub>QE</sub>   | -           | 500               | -           | nm   | Design        |                            |
| <b>KAI-04070-FBA AND KAI-04070-QBA GEN2 COLOR CONFIGURATIONS</b>          |                   |             |                   |             |      |               |                            |
| Peak Quantum Efficiency<br>Blue<br>Green<br>Red                           | QE <sub>MAX</sub> | -<br>-<br>- | 41<br>42<br>37    | -<br>-<br>- | %    | Design        |                            |
| Peak Quantum Efficiency Wavelength<br>Blue<br>Green<br>Red                | λ <sub>QE</sub>   | -<br>-<br>- | 460<br>535<br>610 | -<br>-<br>- | nm   | Design        |                            |
| <b>KAI-04070-CBA AND KAI-04070-PBA GEN1 COLOR CONFIGURATIONS (Note 7)</b> |                   |             |                   |             |      |               |                            |
| Peak Quantum Efficiency<br>Blue<br>Green<br>Red                           | QE <sub>MAX</sub> | -<br>-<br>- | 43<br>42<br>38    | -<br>-<br>- | %    | Design        |                            |
| Peak Quantum Efficiency Wavelength<br>Blue<br>Green<br>Red                | λ <sub>QE</sub>   | -<br>-<br>- | 470<br>540<br>620 | -<br>-<br>- | nm   | Design        |                            |

1. Per color.
2. Value is over the range of 10% to 90% of linear signal level saturation.
3. The operating value of the substrate voltage, V<sub>AB</sub>, will be marked on the shipping container for each device. The value of V<sub>AB</sub> is set such that the photodiode charge capacity is 440 mV. This value is determined while operating the device in the low gain mode. V<sub>AB</sub> value assigned is valid for both modes; high gain or low gain.
4. At 40 MHz.
5. Uses 20LOG (P<sub>Ne</sub> / n<sub>e-T</sub>).
6. Assumes 5 pF load.
7. This color filter set configuration (Gen1) is not recommended for new designs.

Linear Signal Range

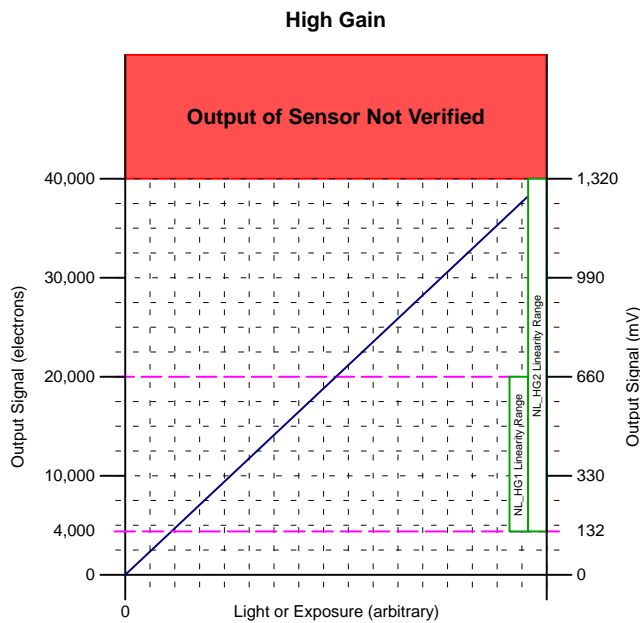

Figure 6. High Gain Linear Signal Range

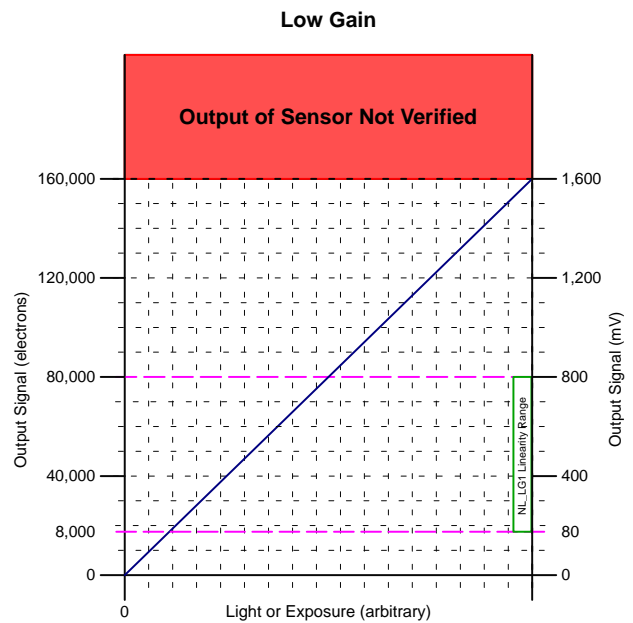

Figure 7. Low Gain Linear Signal Range



TYPICAL PERFORMANCE CURVES

Quantum Efficiency

Monochrome with Microlens

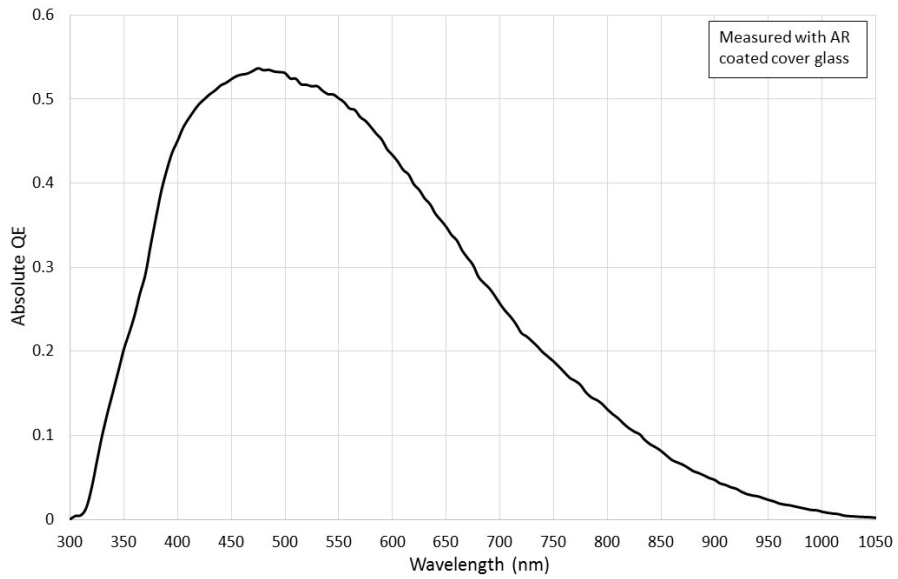

Figure 8. Monochrome with Microlens Quantum Efficiency

Color (Bayer RGB) with Microlens (Gen2 and Gen1 CFA)

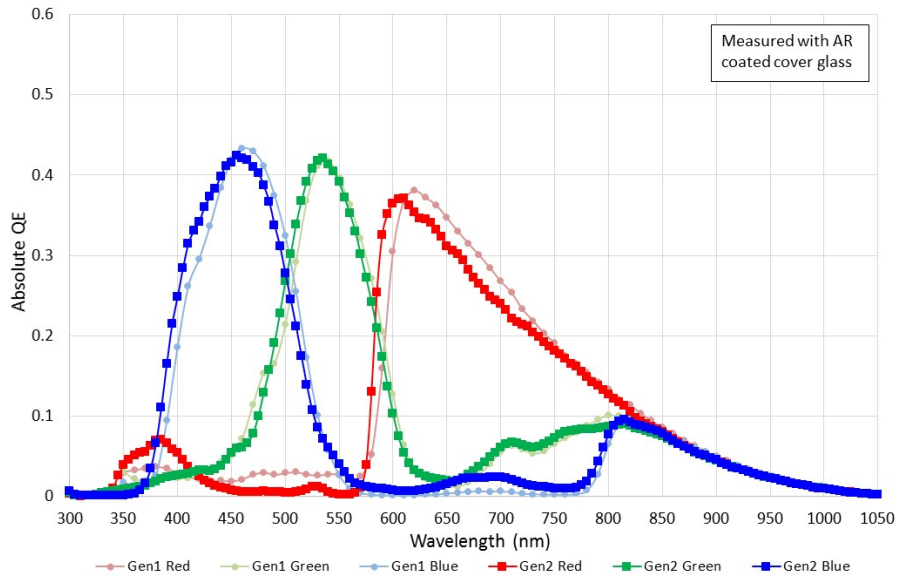

Figure 9. Color (Bayer RGB) with Microlens Quantum Efficiency

Color (TRUESENSE Sparse CFA) with Microlens (Gen2 and Gen1 CFA)

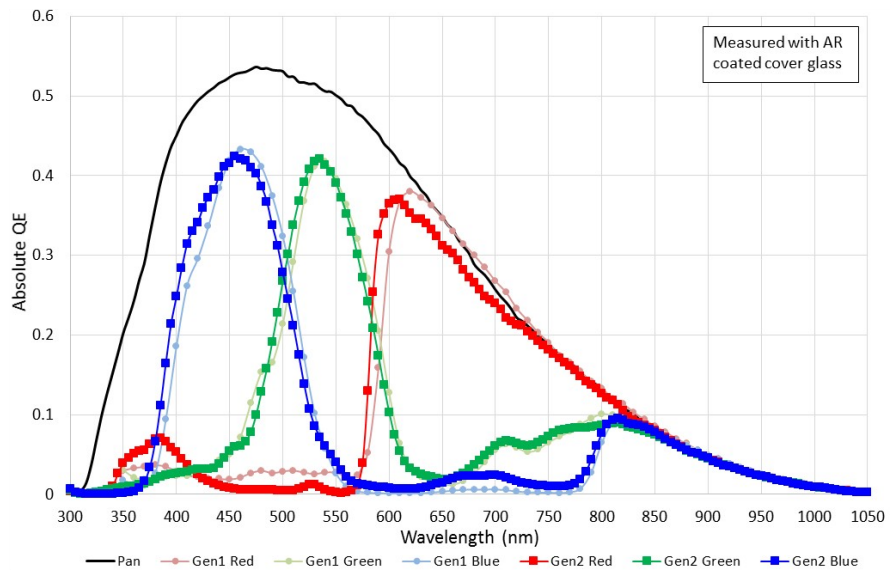

Figure 10. Color (TRUESENSE Sparse CFA) with Microlens Quantum Efficiency

Angular Quantum Efficiency

For the curves marked “Horizontal”, the incident light angle is varied in a plane parallel to the HCCD. For the curves marked “Vertical”, the incident light angle is varied in a plane parallel to the VCCD.

Monochrome with Microlens

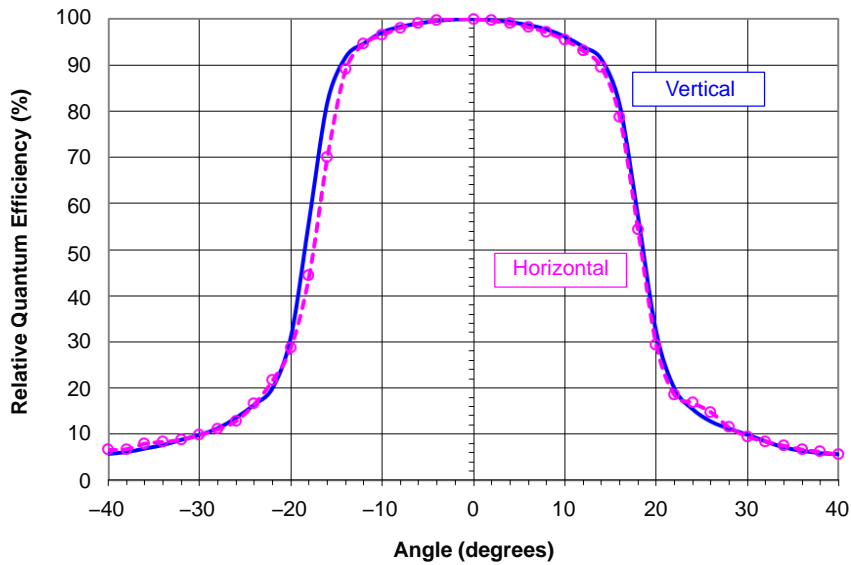

Figure 11. Monochrome with Microlens Angular Quantum Efficiency

Color (Bayer RGB) with Microlens

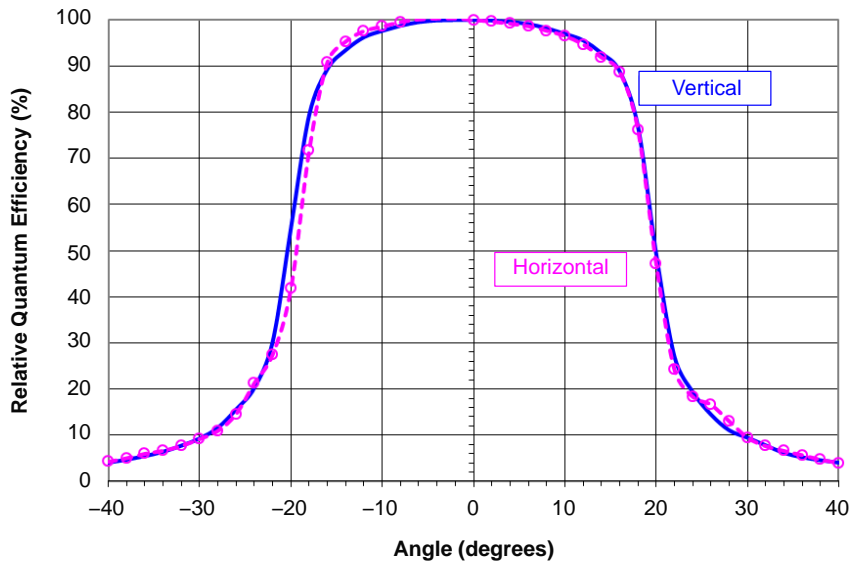

Figure 12. Color (Bayer RGB) with Microlens Angular Quantum Efficiency

Dark Current vs. Temperature

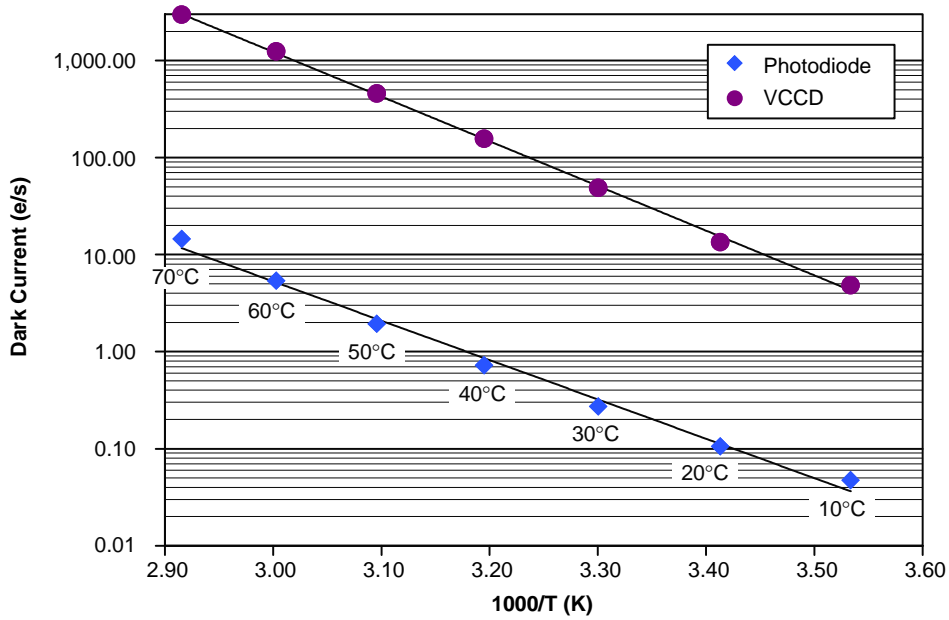

Figure 13. Dark Current vs. Temperature

Power-Estimated

Power-Estimated – Full Resolution

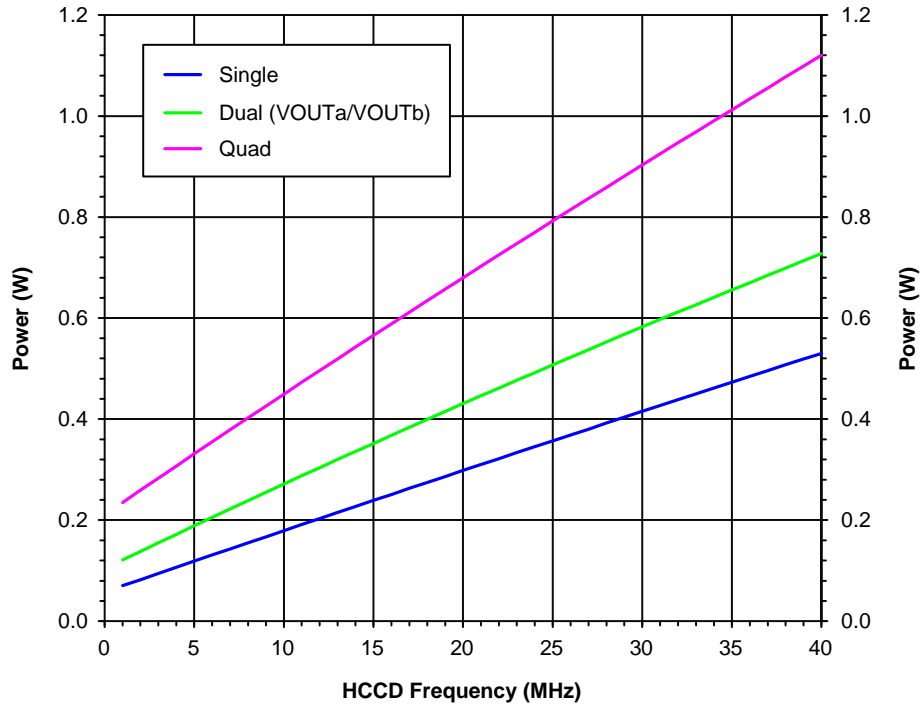

Figure 14. Power – Full Resolution

Power-Estimated – 1/4 Resolution – 2x2 Binning

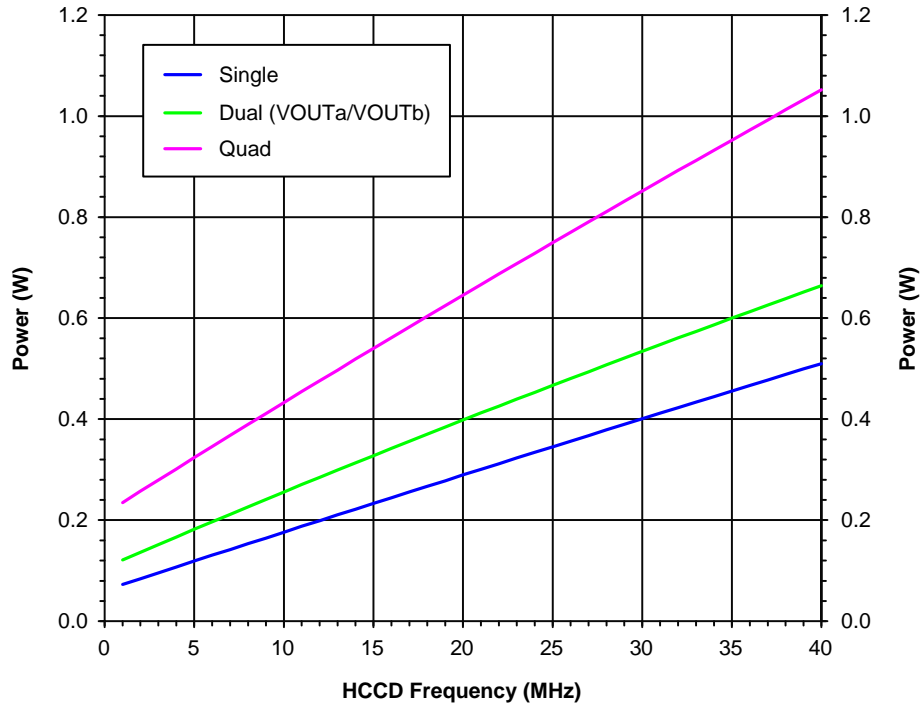

Figure 15. Power – 1/4 Resolution – Constant HCCD

Power-Estimated – 1/4 Resolution – 2x2 Binning using Variable HCCD XLDR

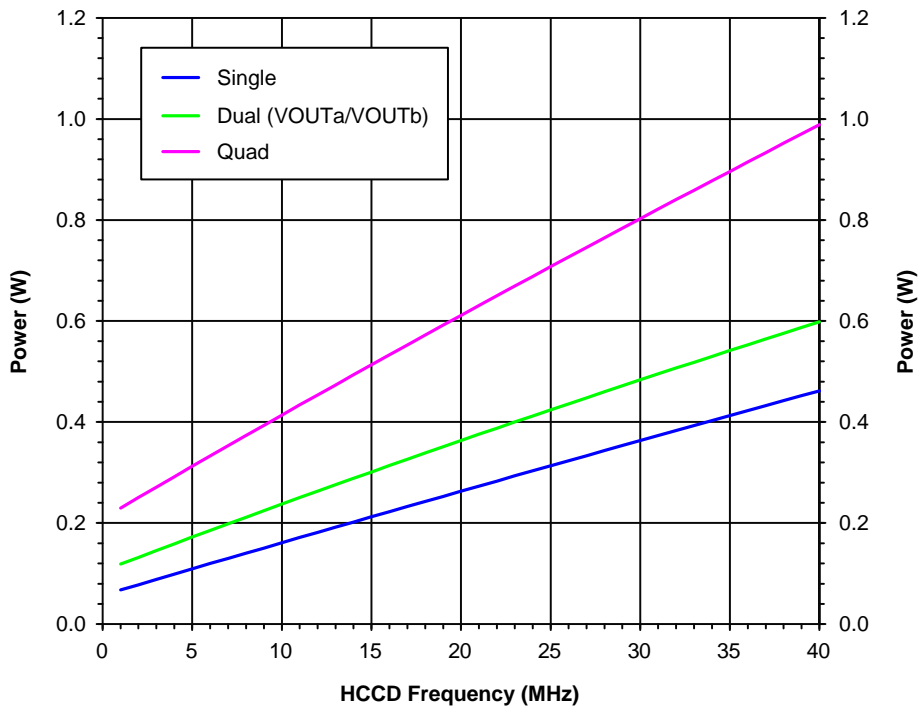

Figure 16. Power – 1/4 Resolution – Variable HCCD XLDR

Power-Estimated – 1/4 Resolution – 2x2 Binning using Constant HCCD XLDR

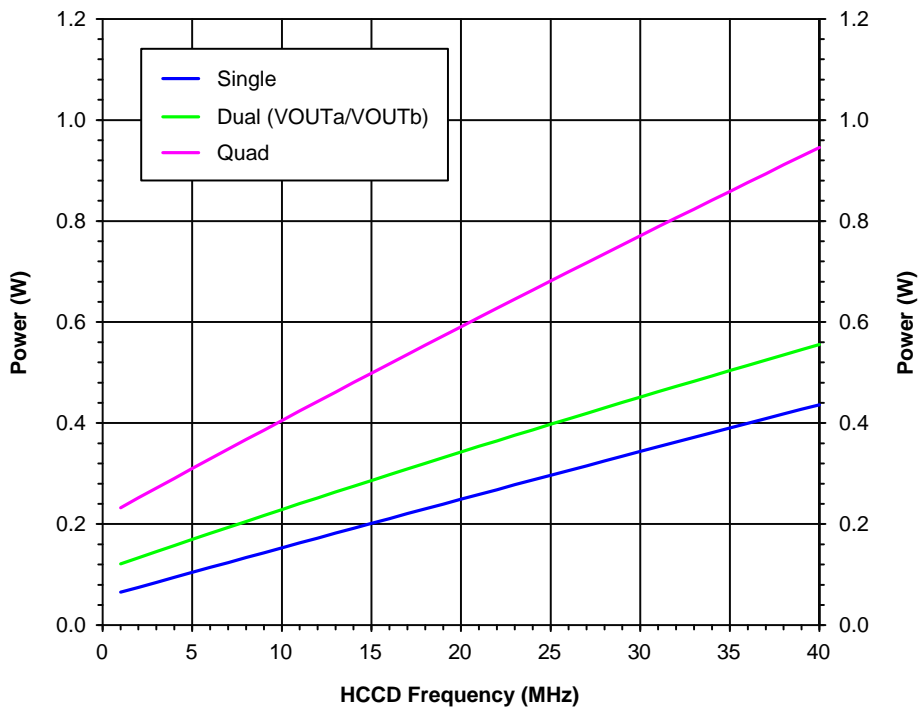

Figure 17. Power – 1/4 Resolution – Constant HCCD XLDR

Frame Rates

Frame Rates – Full Resolution

Frame rates are for low and high gain modes of operation.

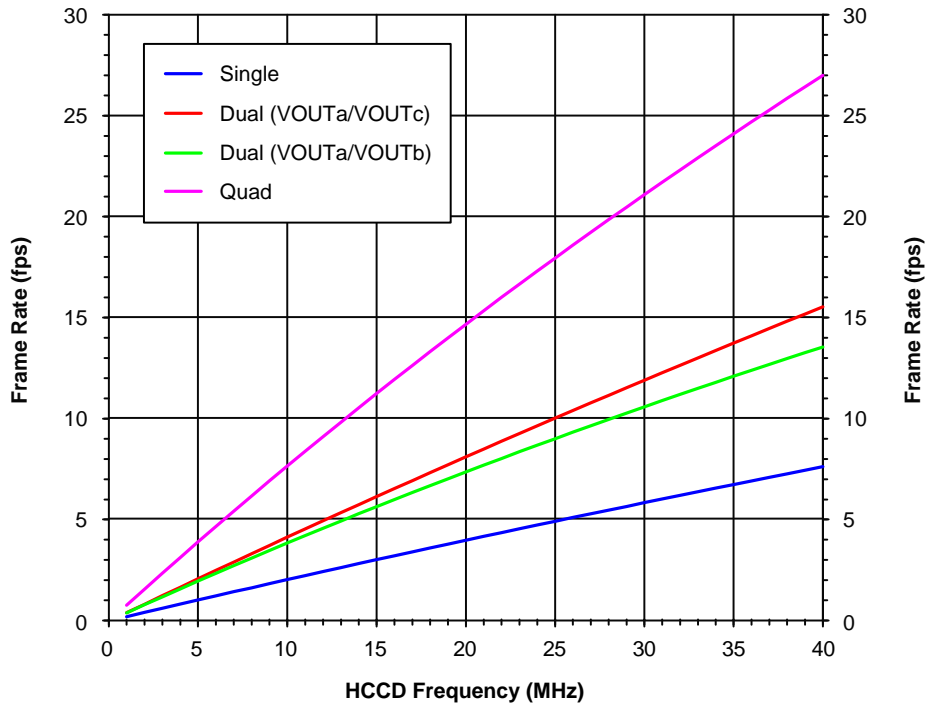

Figure 18. Frame Rates – Full Resolution

Frame Rates – 1/4 Resolution – 2x2 Binning

Frame rates are for low and high gain modes of operation.

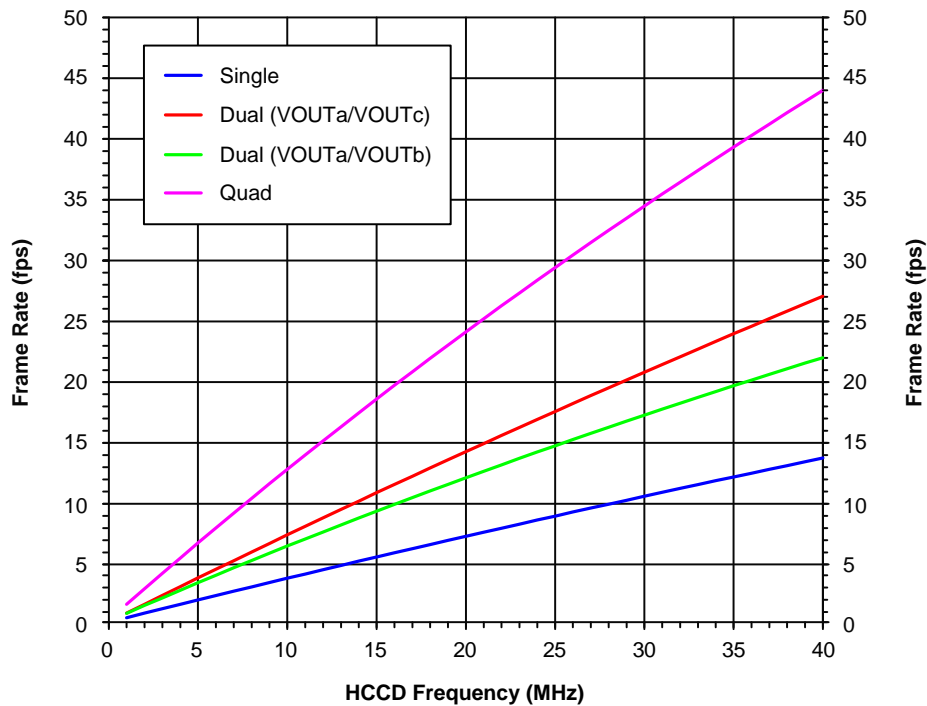

Figure 19. Frame Rates – 1/4 Resolution – Constant HCCD

Frame Rates – 1/4 Resolution – 2x2 Binning using Variable HCCD XLDR

Frame rates for variable HCCD modes of operation.

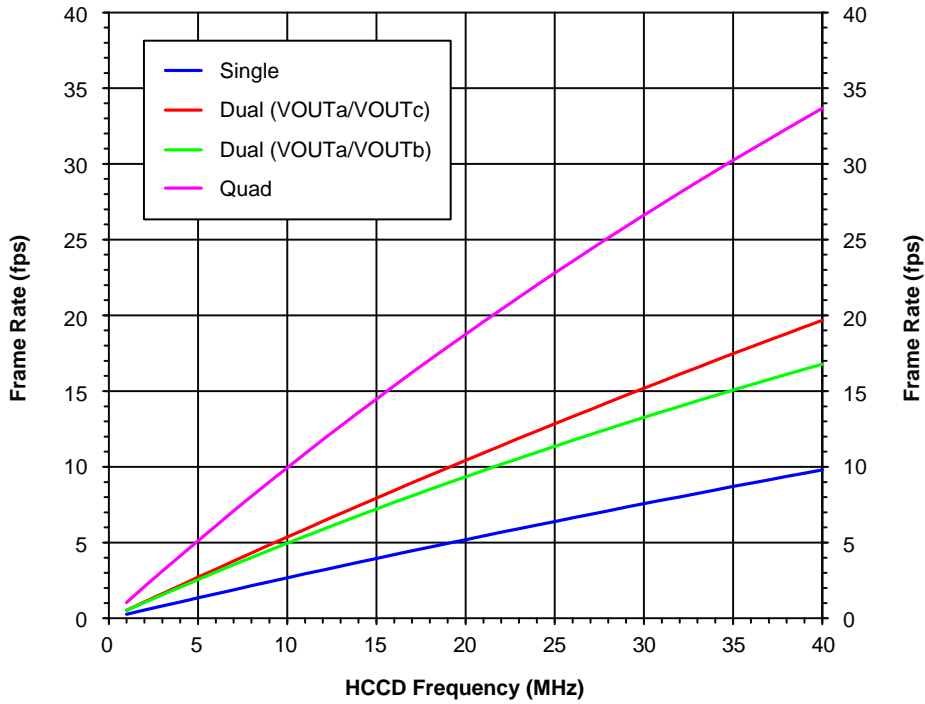

Figure 20. Frame Rates – 1/4 Resolution – Variable HCCD XLDR

Frame Rates – 1/4 Resolution – 2x2 Binning using Constant HCCD XLDR

Frame rates for a constant HCCD mode of operation.

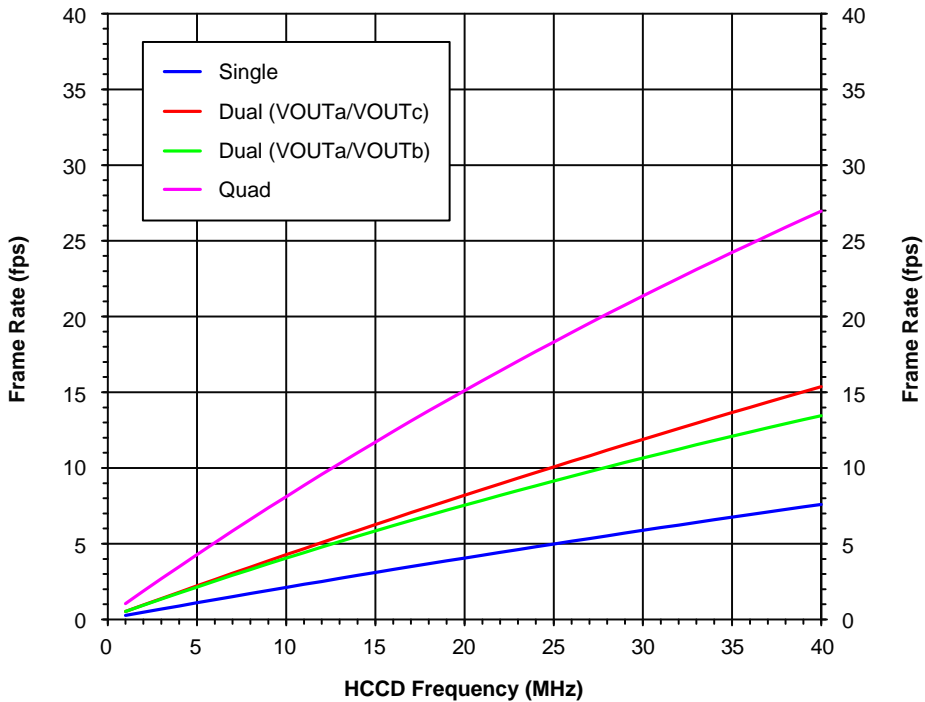

Figure 21. Frame Rates – 1/4 Resolution – Constant HCCD XLDR

**DEFECT DEFINITIONS**

**Table 7. OPERATION CONDITIONS FOR DEFECT TESTING AT 40°C**

| Description                           | Condition   | Notes |
|---------------------------------------|---|-------|
| Operational Mode                      | One Output, using VOUTa, Continuous Readout                 |       |
| HCCD Clock Frequency                  | 20 MHz  |       |
| Pixels per Line                       | 2,140   |       |
| Lines per Frame                       | 2,112   |       |
| Line Time                             | 115.0 $\mu$ s   |       |
| Frame Time                            | 242.9 ms  |       |
| Photodiode Integration Time (PD_Tint) | PD_Tint = Frame Time = 242.9 ms, No Electronic Shutter Used |       |
| Temperature                           | 40°C  |       |
| Light Source                          | Continuous Red, Green and Blue LED Illumination             | 1     |
| Operation                             | Nominal Operating Voltages and Timing                       |       |

1. For monochrome sensor, only the green LED is used.

**Table 8. DEFECT DEFINITIONS FOR TESTING AT 40°C**

| Description                             | Definition   | Standard Grade | Notes |
|---|--|----------------|-------|
| Major Dark Field Defective Bright Pixel | Defect $\geq$ 83 mV  | 40             | 1     |
| Major Bright Field Defective Pixel      | -12% $\geq$ Defect $\geq$ 12%  | 40             | 1     |
| Minor Dark Field Defective Bright Pixel | Defect $\geq$ 41 mV  | 400            |       |
| Cluster Defect                          | A group of 2 to 10 contiguous major defective pixels, but no more than 2 adjacent defect horizontally. | 8              | 2     |
| Column Defect                           | A group of more than 10 contiguous major defective pixels along a single column.                       | 0              | 2     |

1. For the color devices (KAI-04070-CBA and KAI-04070-PBA), a bright field defective pixel deviates by 12% with respect to pixels of the same color.
2. Column and cluster defects are separated by no less than two (2) good pixels in any direction (excluding single pixel defects).



# KAI-04070

**Table 9. OPERATION CONDITIONS FOR DEFECT TESTING AT 27°C**

| Description                           | Condition   | Notes |
|---------------------------------------|---|-------|
| Operational Mode                      | One Output, Using VOUTa, Continuous Readout                 |       |
| HCCD Clock Frequency                  | 20 MHz  |       |
| Pixels per Line                       | 2,140   |       |
| Lines per Frame                       | 2,112   |       |
| Line Time                             | 115 $\mu$ s   |       |
| Frame Time                            | 242.9 ms  |       |
| Photodiode Integration Time (PD_Tint) | PD_Tint = Frame Time = 242.9 ms, No Electronic Shutter Used |       |
| Temperature                           | 27°C  |       |
| Light Source                          | Continuous Red, Green and Blue LED Illumination             | 1     |
| Operation                             | Nominal Operating Voltages and Timing                       |       |

1. For monochrome sensor, only the green LED is used.

**Table 10. DEFECT DEFINITIONS FOR TESTING AT 40°C**

| Description                             | Definition   | Standard Grade | Notes |
|---|--|----------------|-------|
| Major Dark Field Defective Bright Pixel | Defect $\geq$ 27 mV  | 40             | 1     |
| Major Bright Field Defective Pixel      | -12% $\geq$ Defect $\geq$ 12%  | 40             | 1     |
| Cluster Defect                          | A group of 2 to 10 contiguous major defective pixels, but no more than 2 adjacent defect horizontally. | 8              | 2     |
| Column Defect                           | A group of more than 10 contiguous major defective pixels along a single column.                       | 0              | 2     |

1. For the color devices (KAI-04070-CBA and KAI-04070-PBA), a bright field defective pixel deviates by 12% with respect to pixels of the same color.
2. Column and cluster defects are separated by no less than two (2) good pixels in any direction (excluding single pixel defects).

## Defect Map

The defect map supplied with each sensor is based upon testing at an ambient (27°C) temperature. Minor point

defects are not included in the defect map. All defective pixels are reference to pixel 1, 1 in the defect maps. See Figure 22 for the location of pixel 1, 1.

**TEST DEFINITIONS**

**Test Regions of Interest**

Image Area ROI: Pixel (1, 1) to Pixel (2080, 2080)  
 Active Area ROI: Pixel (17, 17) to Pixel (2064, 2064)  
 Center ROI: Pixel (991, 991) to Pixel (1090, 1090)

Only the Active Area ROI pixels are used for performance and defect tests.

**Overclocking**

The test system timing is configured such that the sensor is overclocked in both the vertical and horizontal directions. See Figure 22 for a pictorial representation of the regions of interest.

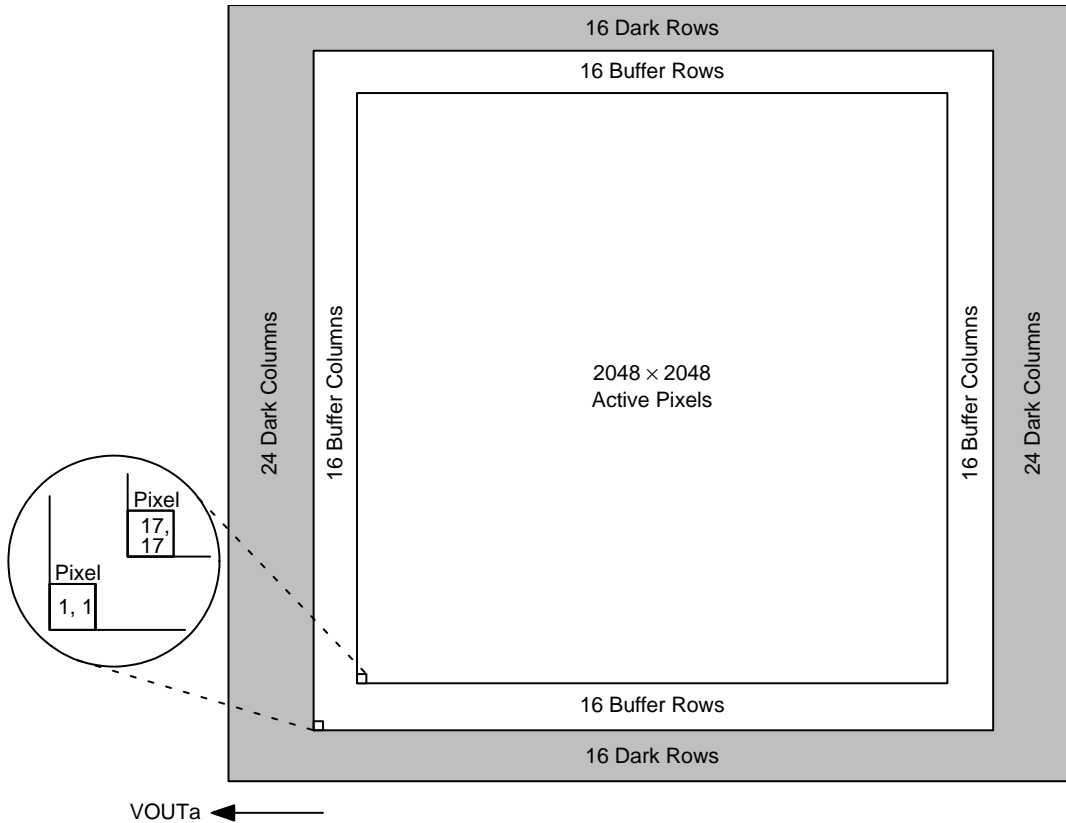

**Figure 22. Regions of Interest**

**Tests**

*Dark Field Global Non-Uniformity*

This test is performed under dark field conditions. The sensor is partitioned into 256 sub regions of interest, each of which is 128 by 128 pixels in size. The average signal level of each of the 256 sub regions of interest is calculated. The signal level of each of the sub regions of interest is calculated using the following formula:

$$\text{Signal of ROI}[i] = (\text{ROI Average in Counts} - \text{Horizontal Overclock Average in Counts}) \cdot \text{mV per Count}$$

Units : mVpp (millivolts Peak to Peak)

where  $i = 1$  to 256. During this calculation on the 256 sub regions of interest, the maximum and minimum signal levels

are found. The dark field global uniformity is then calculated as the maximum signal found minus the minimum signal level found.

*Global Non-Uniformity*

This test is performed with the imager illuminated to a level such that the output is at 70% of saturation (approximately 924 mV). Prior to this test being performed the substrate voltage has been set such that the charge capacity of the sensor is 1,320 mV. Global non-uniformity is defined as

$$\text{Global Non-Uniformity} = 100 \cdot \left( \frac{\text{Active Area Standard Deviation}}{\text{Active Area Signal}} \right)$$

Units : % rms

Active Area Signal = Active Area Average – Dark Column Average

*Global Peak to Peak Non-Uniformity*

This test is performed with the imager illuminated to a level such that the output is at 70% of saturation (approximately 924 mV). Prior to this test being performed the substrate voltage has been set such that the charge capacity of the sensor is 1,320 mV. The sensor is partitioned into 256 sub regions of interest, each of which is 128 by 128 pixels in size. The average signal level of each of the 256 sub regions of interest (ROI) is calculated. The signal level of each of the sub regions of interest is calculated using the following formula:

$$\text{Signal of ROI}[i] = (\text{ROI Average in Counts} - \text{Horizontal Overclock Average in Counts}) \cdot \text{mV per Count}$$

Where  $i = 1$  to 256. During this calculation on the 144 sub regions of interest, the maximum and minimum signal levels are found. The global peak to peak uniformity is then calculated as:

$$\text{Global Uniformity} = 100 \cdot \left( \frac{\text{Max. Signal} - \text{Min. Signal}}{\text{Active Area Signal}} \right)$$

Units : % pp

*Center Non-Uniformity*

This test is performed with the imager illuminated to a level such that the output is at 70% of saturation (approximately 924 mV). Prior to this test being performed the substrate voltage has been set such that the charge capacity of the sensor is 1,320 mV. Defects are excluded for the calculation of this test. This test is performed on the center 100 by 100 pixels of the sensor. Center uniformity is defined as:

$$\text{Center ROI Uniformity} = 100 \cdot \left( \frac{\text{Center ROI Standard Deviation}}{\text{Center ROI Signal}} \right)$$

Units : % rms

Center ROI Signal = Center ROI Average – Dark Column Average

*Dark Field Defect Test*

This test is performed under dark field conditions. The sensor is partitioned into 256 sub regions of interest, each of which is 128 by 128 pixels in size. In each region of interest, the median value of all pixels is found. For each region of interest, a pixel is marked defective if it is greater than or equal to the median value of that region of interest plus the defect threshold specified in the “Detect Definitions” section.

*Bright Field Defect Test*

This test is performed with the imager illuminated to a level such that the output is at approximately 924 mV. Prior to this test being performed the substrate voltage has been set such that the charge capacity of the sensor is 1,320 mV. The average signal level of all active pixels is found. The bright and dark thresholds are set as:

$$\text{Dark Defect Threshold} = \text{Active Area Signal} \cdot \text{Threshold}$$

$$\text{Bright Defect Threshold} = \text{Active Area Signal} \cdot \text{Threshold}$$

The sensor is then partitioned into 256 sub regions of interest, each of which is 128 by 128 pixels in size. In each region of interest, the average value of all pixels is found. For each region of interest, a pixel is marked defective if it is greater than or equal to the median value of that region of interest plus the bright threshold specified or if it is less than or equal to the median value of that region of interest minus the dark threshold specified.

- Example for major bright field defective pixels:
- Average value of all active pixels is found to be 924 mV
- Dark defect threshold:  $924 \text{ mV} \cdot 12\% = 111 \text{ mV}$
- Bright defect threshold:  $924 \text{ mV} \cdot 12\% = 111 \text{ mV}$
- Region of interest #1 selected. This region of interest is pixels 17, 17 to pixels 144, 144
  - ♦ Median of this region of interest is found to be 920 mV
  - ♦ Any pixel in this region of interest that is  $\leq (920 - 111 \text{ mV})$  809 mV in intensity will be marked defective
  - ♦ Any pixel in this region of interest that is  $\geq (920 + 111 \text{ mV})$  1,031 mV in intensity will be marked defective
- All remaining 144 sub regions of interest are analyzed for defective pixels in the same manner

## OPERATION

### Absolute Maximum Ratings

Absolute maximum rating is defined as a level or condition that should not be exceeded at any time per the

description. If the level or the condition is exceeded, the device will be degraded and may be damaged. Operation at these values will reduce MTTF.

**Table 11. ABSOLUTE MAXIMUM RATINGS**

| Description           | Symbol           | Minimum | Maximum | Unit | Notes |
|-----------------------|------------------|---------|---------|------|-------|
| Operating Temperature | T <sub>OP</sub>  | -50     | 70      | °C   | 1     |
| Humidity              | RH               | 5       | 90      | %    | 2     |
| Output Bias Current   | I <sub>OUT</sub> | -       | 60      | mA   | 3     |
| Off-Chip Load         | C <sub>L</sub>   | -       | 10      | pF   |       |

Stresses exceeding those listed in the Maximum Ratings table may damage the device. If any of these limits are exceeded, device functionality should not be assumed, damage may occur and reliability may be affected.

- Noise performance will degrade at higher temperatures.
- T = 25°C. Excessive humidity will degrade MTTF.
- Total for all outputs. Maximum current is -15 mA for each output. Avoid shorting output pins to ground or any low impedance source during operation. Amplifier bandwidth increases at higher current and lower load capacitance at the expense of reduced gain (sensitivity).

**Table 12. ABSOLUTE MAXIMUM VOLTAGE RATINGS BETWEEN PINS AND GROUND**

| Description   | Minimum   | Maximum    | Unit | Notes |
|---|-----------|------------|------|-------|
| VDD <sub>α</sub> , VOUT <sub>α</sub>  | -0.4      | 17.5       | V    | 1     |
| RD <sub>α</sub>   | -0.4      | 15.5       | V    | 1     |
| V1B, V1T  | ESD - 0.4 | ESD + 24.0 | V    |       |
| V2B, V2T, V3B, V3T, V4B, V4T  | ESD - 0.4 | ESD + 14.0 | V    |       |
| H1S <sub>α</sub> , H1B <sub>α</sub> , H2S <sub>α</sub> , H2B <sub>α</sub> , H2SL <sub>α</sub> , R1 <sub>α</sub> , R2 <sub>α</sub> , OG <sub>α</sub> | ESD - 0.4 | ESD + 14.0 | V    | 1     |
| ESD   | -10.0     | 0.0        | V    |       |
| SUB   | -0.4      | 40.0       | V    | 2     |

- α denotes a, b, c or d.
- Refer to Application Note *Using Interline CCD Image Sensors in High Intensity Visible Lighting Conditions*

### KAI-08050 Compatibility

The KAI-04070 is pin-for-pin compatible with a camera designed for the KAI-08050 image sensor with the following accommodations:

- To operate in accordance with a system designed for KAI-08050, the target substrate voltage should be set to be 2.0V higher than the value recorded on the KAI-04070 shipping container. This setting will cause the charge capacity to be limited to 20 ke<sup>-</sup> (or 660 mV)
- On the KAI-04070, pins 17 (R2ab) and 51 (R2cd) should be left floating per the KAI-08050 Device Performance Specification

- The KAI-04070 will operate in only the high gain mode (33 μV/e<sup>-</sup>)
- All timing and voltages are taken from the KAI-08050 specification sheet
- The number of horizontal and vertical CCD clock cycles is reduced as appropriate

In addition, if the intent is to operate the KAI-04070 image sensor in a camera designed for the KAI-08050 sensor that has been modified to accept and process the full 40,000 e<sup>-</sup> (1,320 mV) output, the following changes to the RD bias must be made:

**Table 13.**

| Pins           | Names   | KAI-08050                    | KAI-04070          |
|----------------|---|------------------------------|--------------------|
| 10, 26, 44, 60 | RD <sub>a</sub> , RD <sub>b</sub> , RD <sub>c</sub> , RD <sub>d</sub> | 12.0 V per the Specification | Increase to 12.6 V |

To make use of the low or dual gains modes the KAI-04070 voltages and timing specifications must be used.

**Reset Pin, Low Gain (R2ab and R2cd)**

The R2ab and R2bc (pins 17 and 51) each have an internal circuit to bias the pins to 4.3 V. This feature assures the device is set to operate in the high gain mode when pins 17

and 51 are not connected in the application to a clock driver (for KAI-08050 compatibility). Typical capacitor coupled drivers will not drive this structure.



**Figure 23. Equivalent Circuit for Reset Gate, Low Gain (R2ab and R2cd)**

**Power-Up and Power-Down Sequence**

Adherence to the power-up and power-down sequence is critical. Failure to follow the proper power-up and power-down sequences may cause damage to the sensor.

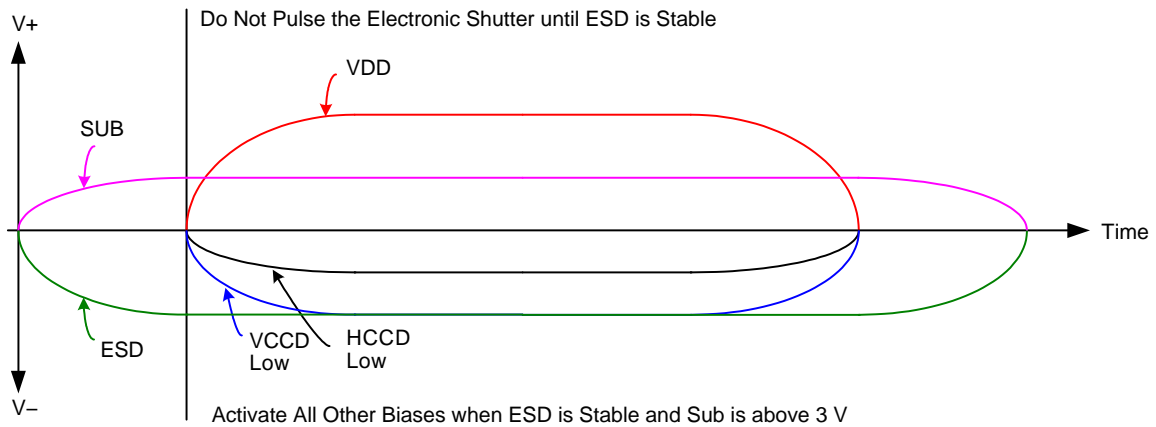

**Notes:**

1. Activate all other biases when ESD is stable and SUB is above 3 V.
2. Do not pulse the electronic shutter until ESD is stable.
3. VDD cannot be +15 V when SUB is 0 V.
4. The image sensor can be protected from an accidental improper ESD voltage by current limiting the SUB current to less than 10 mA. SUB and VDD must always be greater than GND. ESD must always be less than GND. Placing diodes between SUB, VDD, ESD and ground will protect the sensor from accidental overshoots of SUB, VDD and ESD during power on and power off. See the figure below.

**Figure 24. Power-Up and Power-Down Sequence**

# KAI-04070

The VCCD clock waveform must not have a negative overshoot more than 0.4 V below the ESD voltage.



**Figure 25. VCCD Clock Waveform**

Example of external diode protection for SUB, VDD and ESD.  $\alpha$  denotes a, b, c or d.

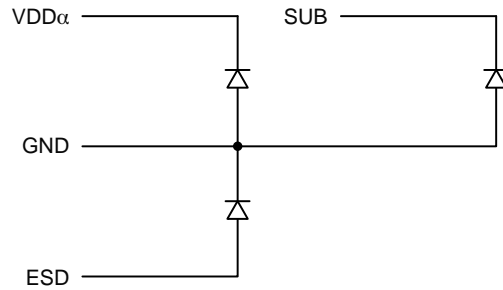

**Figure 26. Example of External Diode Protection**

DC Bias Operating Conditions

Table 14. DC BIAS OPERATING CONDITIONS

| Description             | Pins         | Symbol           | Min. | Nom.            | Max.             | Unit | Max. DC Current | Notes    |
|-------------------------|--------------|------------------|------|-----------------|------------------|------|-----------------|----------|
| Reset Drain             | RD $\alpha$  | RD               | 12.4 | 12.6            | 12.8             | V    | 10 $\mu$ A      | 1, 9     |
| Output Gate             | OG $\alpha$  | OG               | -2.2 | -2.0            | -1.8             | V    | 10 $\mu$ A      | 1        |
| Output Amplifier Supply | VDD $\alpha$ | V <sub>DD</sub>  | 14.5 | 15.0            | 15.5             | V    | 11.0 mA         | 1, 2     |
| Ground                  | GND          | GND              | 0.0  | 0.0             | 0.0              | V    | -1.0 mA         |          |
| Substrate               | SUB          | V <sub>SUB</sub> | 5.0  | V <sub>AB</sub> | V <sub>DD</sub>  | V    | 50 $\mu$ A      | 3, 8     |
| ESD Protection Disable  | ESD          | ESD              | -9.2 | -9.0            | V <sub>X_L</sub> | V    | 50 $\mu$ A      | 6, 7, 10 |
| Output Bias Current     | VOU $\alpha$ | I <sub>OUT</sub> | -3.0 | -5.0            | -10.0            | mA   | -               | 1, 4, 5  |

1.  $\alpha$  denotes a, b, c or d.
2. The maximum DC current is for one output.  $I_{DD} = I_{OUT} + I_{SS}$ . See Figure 27.
3. The operating value of the substrate voltage,  $V_{AB}$ , will be marked on the shipping container for each device. The value of  $V_{AB}$  is set such that the photodiode charge capacity is the nominal  $P_{Ne}$  (see Specifications).
4. An output load sink must be applied to each VOUT pin to activate each output amplifier.
5. Nominal value required for 40 MHz operation per output. May be reduced for slower data rates and lower noise.
6. Adherence to the power-up and power-down sequence is critical. See Sequence section.
7. ESD maximum value must be less than or equal to  $V1\_L + 0.4$  V and  $V2\_L + 0.4$  V.
8. Refer to Application Note *Using Interline CCD Image Sensors in High Intensity Visible Lighting Conditions*.
9. 12.0 V may be used if the total output signal desired is 20,000 e<sup>-</sup> or less.
10. Where  $V_{x\_L}$  is the level set for V1\_L, V2\_L, V3\_L, or V4\_L in the application.



Figure 27. Output Amplifier

AC Operating Conditions

Table 15. CLOCK LEVELS

| Description                                  | Pins<br>(Note 1) | Symbol | Level              | Min. | Nom. | Max. | Unit |
|--|------------------|--------|--------------------|------|------|------|------|
| Vertical CCD Clock, Phase 1                  | V1B, V1T         | V1_L   | Low                | -8.2 | -8.0 | -7.8 | V    |
|  |                  | V1_M   | Mid                | -0.2 | 0.0  | 0.2  |      |
|  |                  | V1_H   | High               | 11.5 | 12.0 | 12.5 |      |
| Vertical CCD Clock, Phase 2                  | V2B, V2T         | V2_L   | Low                | -8.2 | -8.0 | -7.8 | V    |
|  |                  | V2_H   | High               | -0.2 | 0.0  | 0.2  |      |
| Vertical CCD Clock, Phase 3                  | V3B, V3T         | V3_L   | Low                | -8.2 | -8.0 | -7.8 | V    |
|  |                  | V3_H   | High               | -0.2 | 0.0  | 0.2  |      |
| Vertical CCD Clock, Phase 4                  | V4B, V4T         | V4_L   | Low                | -8.2 | -8.0 | -7.8 | V    |
|  |                  | V4_H   | High               | -0.2 | 0.0  | 0.2  |      |
| Horizontal CCD Clock, Phase 1 Storage        | H1S $\alpha$     | H1S_L  | Low                | -5.2 | -4.0 | -3.8 | V    |
|  |                  | H1S_A  | Amplitude (Note 3) | 3.8  | 4.0  | 5.2  |      |
| Horizontal CCD Clock, Phase 1 Barrier        | H1B $\alpha$     | H1B_L  | Low                | -5.2 | -4.0 | -3.8 | V    |
|  |                  | H1B_A  | Amplitude (Note 3) | 3.8  | 4.0  | 5.2  |      |
| Horizontal CCD Clock, Phase 2 Storage        | H2S $\alpha$     | H2S_L  | Low                | -5.2 | -4.0 | -3.8 | V    |
|  |                  | H2S_A  | Amplitude (Note 3) | 3.8  | 4.0  | 5.2  |      |
| Horizontal CCD Clock, Phase 2 Barrier        | H2B $\alpha$     | H2B_L  | Low                | -5.2 | -4.0 | -3.8 | V    |
|  |                  | H2B_A  | Amplitude (Note 3) | 3.8  | 4.0  | 5.2  |      |
| Horizontal CCD Clock, Last Phase<br>(Note 2) | H2SL $\alpha$    | H2SL_L | Low                | -5.2 | -5.0 | -4.8 | V    |
|  |                  | H2SL_A | Amplitude (Note 3) | 4.8  | 5.0  | 5.2  |      |
| Reset Gate                                   | R1 $\alpha$      | R_L    | Low                | -3.2 | -3.0 | -2.8 | V    |
|  |                  | R_A    | Amplitude          | 6.0  | -    | 6.4  |      |
| Reset Gate 2                                 | R2 $\alpha$      | R2_L   | Low                | -2.0 | -1.8 | -1.6 | V    |
|  |                  | R2_A   | Amplitude          | 6.0  | -    | 6.4  |      |
| Electronic Shutter (Note 4)                  | SUB              | VES    | High               | 29.0 | 30.0 | 40.0 | V    |

1.  $\alpha$  denotes a, b, c or d.
2. Use separate clock driver for improved speed performance.
3. The horizontal clock amplitude should be set such that the high level reaches 0.0 V. Examples:
  - a. If the minimum horizontal low voltage of -5.2 V is used, then a 5.2 V amplitude clock is required for a clock swing of -5.2 V to 0.0 V.
  - b. If the maximum horizontal low voltage of -3.8 V is used, then a 3.8 V amplitude clock is required for a clock swing of -3.8 V to 0.0 V.
4. Refer to Application Note *Using Interline CCD Image Sensors in High Intensity Visible Lighting Conditions*.

The figure below shows the DC bias (V<sub>SUB</sub>) and AC clock (VES) applied to the SUB pin. Both the DC bias and AC clock are referenced to ground.

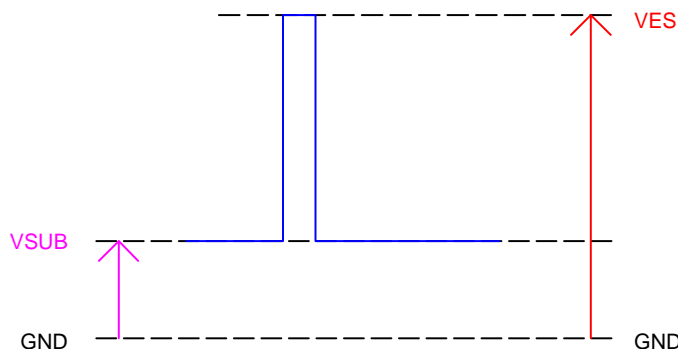

Figure 28. DC Bias and AC Clock Applied to the SUB Pin



Capacitance

Table 16. CAPACITANCE

|      | V1B | V2B | V3B | V4B | V1T | V2T | V3T | V4T | GND | All Pins | Unit |
|------|-----|-----|-----|-----|-----|-----|-----|-----|-----|----------|------|
| V1B  | X   | 4   | 3   | 3   | 2   | 2   | 2   | 1   | 10  | 25       | nF   |
| V2B  | X   | X   | 1   | 3   | 1   | 1   | 1   | 1   | 10  | 20       | nF   |
| V3B  | X   | X   | X   | 5   | 2   | 1   | 2   | 1   | 6   | 23       | nF   |
| V4B  | X   | X   | X   | X   | 2   | 1   | 1   | 1   | 13  | 23       | nF   |
| V1T  | X   | X   | X   | X   | X   | 2   | 3   | 2   | 20  | 29       | nF   |
| V2T  | X   | X   | X   | X   | X   | X   | 5   | 3   | 4   | 21       | nF   |
| V3T  | X   | X   | X   | X   | X   | X   | X   | 2   | 9   | 24       | nF   |
| V4T  | X   | X   | X   | X   | X   | X   | X   | X   | 3   | 20       | nF   |
| VSUB | 0.5 | 0.5 | 0.5 | 0.5 | 0.5 | 0.5 | 0.5 | 0.5 | 2.8 | 2.8      | nF   |

|     | H2S | H1B | H2B | GND | All Pins | Unit |
|-----|-----|-----|-----|-----|----------|------|
| H1S | 32  | 29  | 29  | 120 | 210      | pF   |
| H2S | X   | 16  | 21  | 170 | 240      | pF   |
| H1B | X   | X   | 7   | 155 | 210      | pF   |
| H2B | X   | X   | X   | 165 | 235      | pF   |

1. Tables show typical cross capacitance between pins of the device.
2. Capacitance is total for all like pins.
3. Capacitance values are estimated.

Device Identification

The device identification pin (DevID) may be used to determine which Truesense Imaging 7.4 micron pixel interline CCD sensor is being used.

Table 17. DEVICE IDENTIFICATION

| Description           | Pins  | Symbol | Min.   | Nom.   | Max.   | Unit     | Max. DC Current | Notes   |
|-----------------------|-------|--------|--------|--------|--------|----------|-----------------|---------|
| Device Identification | DevID | DevID  | 64,000 | 74,000 | 84,000 | $\Omega$ | 50 $\mu$ A      | 1, 2, 3 |

1. Nominal value subject to verification and/or change during release of preliminary specifications.
2. If the Device Identification is not used, it may be left disconnected.
3. After Device Identification resistance has been read during camera initialization, it is recommended that the circuit be disabled to prevent localized heating of the sensor due to current flow through the R\_DeviceID resistor.

Recommended Circuit

Note that V1 must be a different value than V2.

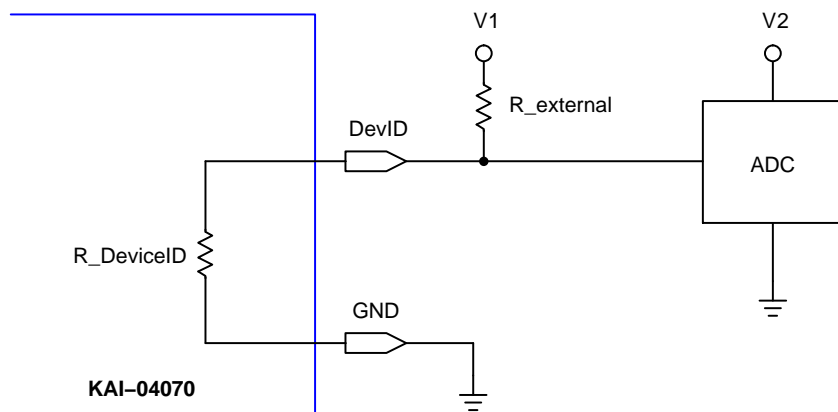

Figure 29. Device Identification Recommended Circuit

**TIMING**

**Requirements and Characteristics**

**Table 18. REQUIREMENTS AND CHARACTERISTICS**

| Description                                       | Symbol           | Min.  | Nom. | Max. | Unit          | Notes               |
|---|------------------|-------|------|------|---------------|---------------------|
| Photodiode Transfer                               | $t_{PD}$         | 1.0   | –    | –    | $\mu\text{s}$ |                     |
| VCCD Leading Pedestal                             | $t_{3P}$         | 4.0   | –    | –    | $\mu\text{s}$ |                     |
| VCCD Trailing Pedestal                            | $t_{3D}$         | 4.0   | –    | –    | $\mu\text{s}$ |                     |
| VCCD Transfer                                     | $t_V$            | 2.0   | –    | –    | $\mu\text{s}$ |                     |
| VCCD Clock Cross-Over                             | $V_{VCR}$        | 75    | –    | 100  | %             | 1                   |
| VCCD Rise, Fall Times                             | $t_{VR}, t_{VF}$ | 5     | –    | 10   | %             | 1, 2                |
| HCCD Delay  | $t_{HS}$         | 2.0   | –    | –    | $\mu\text{s}$ |                     |
| HCCD Transfer                                     | $t_e$            | 25.0  | –    | –    | ns            |                     |
| Shutter Transfer                                  | $t_{SUB}$        | 2.0   | –    | –    | $\mu\text{s}$ |                     |
| Shutter Delay                                     | $t_{HD}$         | 2.0   | –    | –    | $\mu\text{s}$ |                     |
| Reset Pulse                                       | $t_R$            | 2.5   | –    | –    | ns            |                     |
| Reset – Video Delay                               | $t_{RV}$         | –     | 2.2  | –    | ns            |                     |
| H2SL – Video Delay                                | $t_{HV}$         | –     | 3.1  | –    | ns            |                     |
| Line Time   | $t_{LINE}$       | 34.9  | –    | –    | $\mu\text{s}$ | Dual HCCD Readout   |
|   |                  | 61.5  | –    | –    | $\mu\text{s}$ | Single HCCD Readout |
| Frame Time  | $t_{FRAME}$      | 36.9  | –    | –    | ms            | Quad HCCD Readout   |
|   |                  | 73.8  | –    | –    | ms            | Dual HCCD Readout   |
|   |                  | 129.9 | –    | –    | ms            | Single HCCD Readout |
| Line Time (XLDR Bin 2x2)                          | $t_{LINE}$       | 69.8  | –    | –    | $\mu\text{s}$ | Dual HCCD Readout   |
|   |                  | 123.0 | –    | –    | $\mu\text{s}$ | Single HCCD Readout |
| Frame Time (XLDR Bin 2x2)<br>Constant HCCD Timing | $t_{FRAME}$      | 36.9  | –    | –    | ms            | Quad HCCD Readout   |
|   |                  | 73.7  | –    | –    | ms            | Dual HCCD Readout   |
|   |                  | 129.9 | –    | –    | ms            | Single HCCD Readout |
| Frame Time (XLDR Bin 2x2)<br>Variable HCCD Timing | $t_{FRAME}$      | 29.8  | –    | –    | ms            | Quad HCCD Readout   |
|   |                  | 59.5  | –    | –    | ms            | Dual HCCD Readout   |
|   |                  | 101.7 | –    | –    | ms            | Single HCCD Readout |

1. Refer to Figure 47: VCCD Clock Rise Time, Fall Time, and Edge Alignment.
2. Relative to the VCCD Transfer pulse width,  $t_V$ .

**Timing Flow Charts**

In the timing flow charts the number of HCCD clock cycles per row, NH, and the number of VCCD clock cycles per frame, NV, are shown in the following table.

**Table 19. VALUES FOR NH AND NV WHEN OPERATING THE SENSOR IN THE VARIOUS MODES OF RESOLUTION**

|                   | Full Resolution |      | 1/4 Resolution |      | XLDR |      |
|-------------------|-----------------|------|----------------|------|------|------|
|                   | NV              | NH   | NV             | NH   | NV   | NH   |
| Quad              | 1056            | 1076 | 528            | 538  | 528  | 538  |
| Dual VOUTa, VOUTc | 1056            | 2152 | 528            | 1076 | 528  | 1076 |
| Dual VOUTa, VOUTb | 2112            | 1076 | 1056           | 538  | 1056 | 538  |
| Single VOUTa      | 2112            | 2152 | 1056           | 1076 | 1056 | 1076 |

1. The time to read out one line  $t_{LINE} = \text{Line Timing} + NH / (\text{Pixel Frequency})$ .
2. The time to read out one frame  $t_{FRAME} = NV \cdot t_{LINE} + \text{Frame Timing}$ .
3. Line Timing: See Table 21: Line Timing.
4. Frame Timing: See Table 20: Frame Timing.
5. XLDR: eXtended Linear Dynamic Range.

*No Electronic Shutter*

In this case the photodiode exposure time is equal to the time to read out an image. This flow chart applies to both full and 1/4 resolution modes.

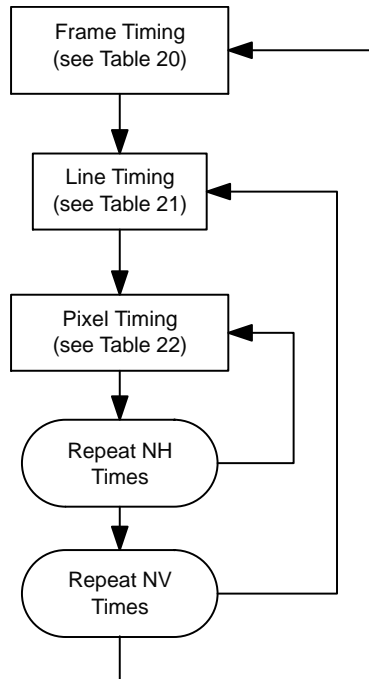
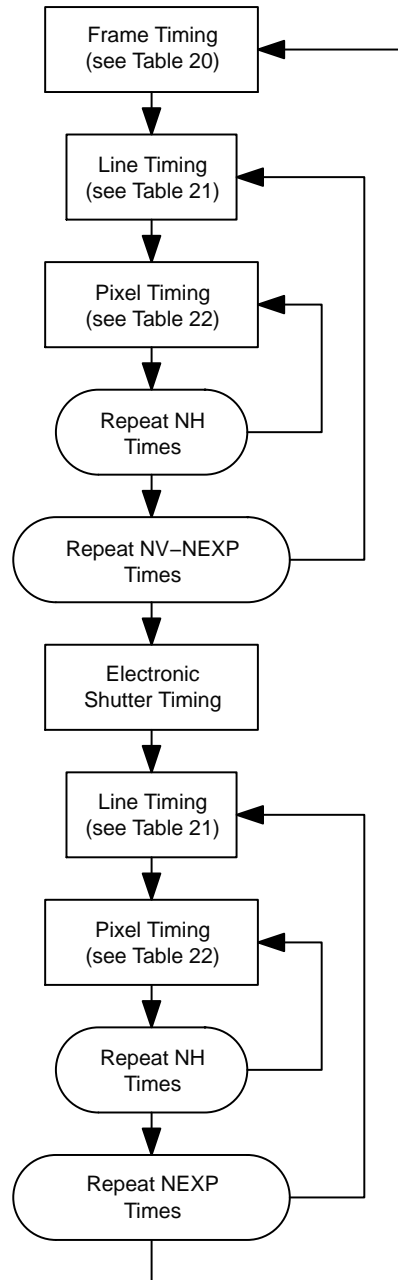

**Figure 30. Timing Flow when Electronic Shutter is Not Used**

*Using the Electronic Shutter*

This flow chart applies to both the full and 1/4 resolution modes. The exposure time begins on the falling edge of the electronic shutter pulse on the SUB pin. The exposure time

ends on the falling edge of the photodiode transfer ( $t_{PD}$ ) of the V1T and V1B pins. The electronic shutter timing is shown in Figure 38.



NOTE: NEXP: Exposure time in increments of number of lines.

**Figure 31. Timing Flow Chart using the Electronic Shutter for Exposure Control**

Timing Tables

Frame Timing

This timing table is for transferring charge from the photodiodes to the VCCD. See Figures 32 and 33 for frame timing diagrams.

Table 20. FRAME TIMING

| Device Pin   | Full Resolution, High Gain or Low Gain |                  |                  |              | 1/4 Resolution, High Gain or Low Gain |                  |                  |              | 1/4 Resolution XLDR |                  |                  |              |
|--------------|--|------------------|------------------|--------------|---------------------------------------|------------------|------------------|--------------|---------------------|------------------|------------------|--------------|
|              | Quad                                   | Dual VOUTa VOUTc | Dual VOUTa VOUTb | Single VOUTa | Quad                                  | Dual VOUTa VOUTc | Dual VOUTa VOUTb | Single VOUTa | Quad                | Dual VOUTa VOUTc | Dual VOUTa VOUTb | Single VOUTa |
| V1T          | F1T                                    |                  | F1B              |              | F1T                                   |                  | F1B              |              | F1T                 |                  | F1B              |              |
| V2T          | F2T                                    |                  | F4B              |              | F2T                                   |                  | F4B              |              | F2T                 |                  | F4B              |              |
| V3T          | F3T                                    |                  | F3B              |              | F3T                                   |                  | F3B              |              | F3T                 |                  | F3B              |              |
| V4T          | F4T                                    |                  | F2B              |              | F4T                                   |                  | F2B              |              | F4T                 |                  | F2B              |              |
| V1B          | F1B                                    |                  |                  |              | F1B                                   |                  |                  |              | F1B                 |                  |                  |              |
| V2B          | F2B                                    |                  |                  |              | F2B                                   |                  |                  |              | F2B                 |                  |                  |              |
| V3B          | F3B                                    |                  |                  |              | F3B                                   |                  |                  |              | F3B                 |                  |                  |              |
| V4B          | F4B                                    |                  |                  |              | F4B                                   |                  |                  |              | F4B                 |                  |                  |              |
| H1Sa         | P1                                     |                  |                  |              | P1Q                                   |                  |                  |              | P1XL                |                  |                  |              |
| H1Ba         | P1                                     |                  |                  |              | P1Q                                   |                  |                  |              | P1XL                |                  |                  |              |
| H2Sa         | P2                                     |                  |                  |              | P2Q                                   |                  |                  |              | P2XL                |                  |                  |              |
| H2Ba         | P2                                     |                  |                  |              | P2Q                                   |                  |                  |              | P2XL                |                  |                  |              |
| Ra           | RHG/RLG                                |                  |                  |              | RHGQ/RLGQ                             |                  |                  |              | RXL                 |                  |                  |              |
| H1Sb         | P1                                     |                  |                  |              | P1Q                                   |                  |                  |              | P1XL                |                  |                  |              |
| H1Bb         | P1                                     | P2               | P1               | P2           | P1Q                                   | P2Q              | P1Q              | P2Q          | P1XL                | P2XL             | P1XL             | P2XL         |
| H2Sb         | P2                                     |                  |                  |              | P2Q                                   |                  |                  |              | P2XL                |                  |                  |              |
| H2Bb         | P2                                     | P1               | P2               | P1           | P2Q                                   | P1Q              | P2Q              | P1Q          | P2XL                | P1XL             | P2XL             | P1XL         |
| Rb           | RHG/RLG                                | (Note 1)         | RHG/RLG          | (Note 1)     | RHGQ/RLGQ                             | (Note 1)         | RHGQ/RLGQ        | (Note 1)     | RXL                 | (Note 1)         | RXL              | (Note 1)     |
| R2ab         | R2HG/R2LG                              |                  |                  |              | R2HGQ/R2LGQ                           |                  |                  |              | R2XL                |                  |                  |              |
| H1Sc         | P1                                     |                  | (Note 1)         |              | P1Q                                   |                  | (Note 1)         |              | P1XL                |                  | (Note 1)         |              |
| H1Bc         | P1                                     |                  | (Note 1)         |              | P1Q                                   |                  | (Note 1)         |              | P1XL                |                  | (Note 1)         |              |
| H2Sc         | P2                                     |                  | (Note 1)         |              | P2Q                                   |                  | (Note 1)         |              | P2XL                |                  | (Note 1)         |              |
| H2Bc         | P2                                     |                  | (Note 1)         |              | P2Q                                   |                  | (Note 1)         |              | P2XL                |                  | (Note 1)         |              |
| Rc           | RHG/RLG                                |                  | (Note 1)         |              | RHGQ/RLGQ                             |                  | (Note 1)         |              | RXL                 |                  | (Note 1)         |              |
| H1Sd         | P1                                     |                  | (Note 1)         |              | P1Q                                   |                  | (Note 1)         |              | P1XL                |                  | (Note 1)         |              |
| H1Bd         | P1                                     | P2               | (Note 1)         |              | P1Q                                   | P2Q              | (Note 1)         |              | P1XL                | P2XL             | (Note 1)         |              |
| H2Sd         | P2                                     |                  | (Note 1)         |              | P2Q                                   |                  | (Note 1)         |              | P2XL                |                  | (Note 1)         |              |
| H2Bd         | P2                                     | P1               | (Note 1)         |              | P2Q                                   | P1Q              | (Note 1)         |              | P2XL                | P1XL             | (Note 1)         |              |
| Rd           | RHG/RLG                                | (Note 1)         | (Note 1)         |              | RHGQ/RLGQ                             | (Note 1)         | (Note 1)         |              | RXL                 | (Note 1)         | (Note 1)         |              |
| R2cd         | R2HG/R2LG                              |                  | (Note 1)         |              | R2HGQ/R2LGQ                           |                  | (Note 1)         |              | R2XL                |                  | (Note 1)         |              |
| SHP (Note 2) | SHP1                                   |                  |                  |              | SHPQ                                  |                  |                  |              | (Note 4)            |                  |                  |              |
| SHD (Note 2) | SHD1                                   |                  |                  |              | SHDQ                                  |                  |                  |              | (Note 5)            |                  |                  |              |

1. This clock should be held at its high level voltage (0 V) or held at +5.0 V for compatibility with TRUESENSE 5.5 micron Interline Transfer CCD family of products.
2. SHP and SHD are the sample clocks for the analog front end (AFE) signal processor.
3. This note intentionally left empty.
4. Use SHPLG for the AFE processing the low gain signal. Use SHPHG for the AFE processing the high gain signal.
5. Use SHDLG for the AFE processing the low gain signal. Use SHDHG for the AFE processing the high gain signal.

Line Timing

This timing is for transferring one line of charge from the VCCD to the HCCD. See Figure 34, Figure 35, Figure 36 and Figure 37 for line timing diagrams.

**Table 21. LINE TIMING**

| Device Pin   | Full Resolution, High Gain or Low Gain |                  |                  |              | 1/4 Resolution, High Gain or Low Gain |                  |                  |              | 1/4 Resolution XLDR |                  |                  |              |
|--------------|--|------------------|------------------|--------------|---------------------------------------|------------------|------------------|--------------|---------------------|------------------|------------------|--------------|
|              | Quad                                   | Dual VOUTa VOUTc | Dual VOUTa VOUTb | Single VOUTa | Quad                                  | Dual VOUTa VOUTc | Dual VOUTa VOUTb | Single VOUTa | Quad                | Dual VOUTa VOUTc | Dual VOUTa VOUTb | Single VOUTa |
| V1T          | L1T                                    |                  | L1B              |              | 2 × L1T                               |                  | 2 × L1B          |              | 2 × L1T             |                  | 2 × L1B          |              |
| V2T          | L2T                                    |                  | L4B              |              | 2 × L2T                               |                  | 2 × L4B          |              | 2 × L2T             |                  | 2 × L4B          |              |
| V3T          | L3T                                    |                  | L3B              |              | 2 × L3T                               |                  | 2 × L3B          |              | 2 × L3T             |                  | 2 × L3B          |              |
| V4T          | L4T                                    |                  | L2B              |              | 2 × L4T                               |                  | 2 × L2B          |              | 2 × L4T             |                  | 2 × L2B          |              |
| V1B          | L1B                                    |                  |                  |              | 2 × L1B                               |                  |                  |              | 2 × L1B             |                  |                  |              |
| V2B          | L2B                                    |                  |                  |              | 2 × L2B                               |                  |                  |              | 2 × L2B             |                  |                  |              |
| V3B          | L3B                                    |                  |                  |              | 2 × L3B                               |                  |                  |              | 2 × L3B             |                  |                  |              |
| V4B          | L4B                                    |                  |                  |              | 2 × L4B                               |                  |                  |              | 2 × L4B             |                  |                  |              |
| H1Sa         | P1L                                    |                  |                  |              | P1LQ                                  |                  |                  |              | P1XL                |                  |                  |              |
| H1Ba         | P1L                                    |                  |                  |              | P1LQ                                  |                  |                  |              | P1XL                |                  |                  |              |
| H2Sa         | P2L                                    |                  |                  |              | P2LQ                                  |                  |                  |              | P2XL                |                  |                  |              |
| H2Ba         | P2L                                    |                  |                  |              | P2LQ                                  |                  |                  |              | P2XL                |                  |                  |              |
| Ra           | RHG/RLG                                |                  |                  |              | RHGQ/RLGQ                             |                  |                  |              | RXL                 |                  |                  |              |
| H1Sb         | P1L                                    |                  |                  |              | P1LQ                                  |                  |                  |              | P1XL                |                  |                  |              |
| H1Bb         | P1L                                    | P2L              | P1L              | P2L          | P1LQ                                  | P2LQ             | P1LQ             | P2LQ         | P1XL                | P2XL             | P1XL             | P2XL         |
| H2Sb         | P2L                                    |                  |                  |              | P2LQ                                  |                  |                  |              | P2XL                |                  |                  |              |
| H2Bb         | P2L                                    | P1L              | P2L              | P1L          | P2LQ                                  | P1LQ             | P2LQ             | P1LQ         | P2XL                | P1XL             | P2XL             | P1XL         |
| Rb           | RHG/RLG                                | (Note 1)         | RHG/RLG          | (Note 1)     | RHGQ/RLGQ                             | (Note 1)         | RHGQ/RLGQ        | (Note 1)     | RXL                 | (Note 1)         | RXL              | (Note 1)     |
| R2ab         | R2HG/R2LG                              |                  |                  |              | R2HGQ/R2LGQ                           |                  |                  |              | R2XL                |                  |                  |              |
| H1Sc         | P1L                                    |                  | (Note 1)         |              | P1LQ                                  |                  | (Note 1)         |              | P1XL                |                  | (Note 1)         |              |
| H1Bc         | P1L                                    |                  | (Note 1)         |              | P1LQ                                  |                  | (Note 1)         |              | P1XL                |                  | (Note 1)         |              |
| H2Sc         | P2L                                    |                  | (Note 1)         |              | P2LQ                                  |                  | (Note 1)         |              | P2XL                |                  | (Note 1)         |              |
| H2Bc         | P2L                                    |                  | (Note 1)         |              | P2LQ                                  |                  | (Note 1)         |              | P2XL                |                  | (Note 1)         |              |
| Rc           | RHG/RLG                                |                  | (Note 1)         |              | RHGQ/RLGQ                             |                  | (Note 1)         |              | RXL                 |                  | (Note 1)         |              |
| H1Sd         | P1L                                    |                  | (Note 1)         |              | P1LQ                                  |                  | (Note 1)         |              | P1XL                |                  | (Note 1)         |              |
| H1Bd         | P1L                                    | P2L              | (Note 1)         |              | P1LQ                                  | P2LQ             | (Note 1)         |              | P1XL                | P2XL             | (Note 1)         |              |
| H2Sd         | P2L                                    |                  | (Note 1)         |              | P2LQ                                  |                  | (Note 1)         |              | P2XL                |                  | (Note 1)         |              |
| H2Bd         | P2L                                    | P1L              | (Note 1)         |              | P2LQ                                  | P1LQ             | (Note 1)         |              | P2XL                | P1XL             | (Note 1)         |              |
| Rd           | RHG/RLG                                | (Note 1)         | (Note 1)         |              | RHGQ/RLGQ                             | (Note 1)         | (Note 1)         |              | RXL                 | (Note 1)         | (Note 1)         |              |
| R2cd         | R2HG/R2LG                              |                  | (Note 1)         |              | R2HGQ/R2LGQ                           |                  | (Note 1)         |              | R2XL                |                  | (Note 1)         |              |
| SHP (Note 2) | SHP1                                   |                  |                  |              | SHPQ                                  |                  |                  |              | (Note 4)            |                  |                  |              |
| SHD (Note 2) | SHD1                                   |                  |                  |              | SHDQ                                  |                  |                  |              | (Note 5)            |                  |                  |              |

1. This clock should be held at its high level voltage (0 V) or held at +5.0 V for compatibility with TRUESENSE 5.5 micron Interline Transfer CCD family of products.
2. SHP and SHD are the sample clocks for the analog front end (AFE) signal processor.
3. The notation 2 × L1B means repeat the L1B timing twice for every line. This sums two rows into the HCCD.
4. Use SHPLG for the AFE processing the low gain signal. Use SHPHG for the AFE processing the high gain signal.
5. Use SHDLG for the AFE processing the low gain signal. Use SHDHG for the AFE processing the high gain signal.

Pixel Timing

This timing is for transferring one pixel from the HCCD to the output amplifier.

Table 22. PIXEL TIMING

| Device Pin   | Full Resolution, High Gain or Low Gain |                  |                  |              | 1/4 Resolution, High Gain or Low Gain |                  |                  |              | 1/4 Resolution XLDR |                  |                  |              |
|--------------|--|------------------|------------------|--------------|---------------------------------------|------------------|------------------|--------------|---------------------|------------------|------------------|--------------|
|              | Quad                                   | Dual VOUTa VOUTc | Dual VOUTa VOUTb | Single VOUTa | Quad                                  | Dual VOUTa VOUTc | Dual VOUTa VOUTb | Single VOUTa | Quad                | Dual VOUTa VOUTc | Dual VOUTa VOUTb | Single VOUTa |
| V1T          | -8 V                                   |                  |                  |              | -8 V                                  |                  |                  |              | -8 V                |                  |                  |              |
| V2T          | -8 V                                   |                  |                  |              | -8 V                                  |                  |                  |              | -8 V                |                  |                  |              |
| V3T          | 0 V                                    |                  |                  |              | 0 V                                   |                  |                  |              | 0 V                 |                  |                  |              |
| V4T          | 0 V                                    |                  |                  |              | 0 V                                   |                  |                  |              | 0 V                 |                  |                  |              |
| V1B          | -8 V                                   |                  |                  |              | -8 V                                  |                  |                  |              | -8 V                |                  |                  |              |
| V2B          | 0 V                                    |                  |                  |              | 0 V                                   |                  |                  |              | 0 V                 |                  |                  |              |
| V3B          | 0 V                                    |                  |                  |              | 0 V                                   |                  |                  |              | 0 V                 |                  |                  |              |
| V4B          | -8 V                                   |                  |                  |              | -8 V                                  |                  |                  |              | -8 V                |                  |                  |              |
| H1Sa         | P1                                     |                  |                  |              | P1Q                                   |                  |                  |              | P1XL                |                  |                  |              |
| H1Ba         | P1                                     |                  |                  |              | P1Q                                   |                  |                  |              | P1XL                |                  |                  |              |
| H2Sa         | P2                                     |                  |                  |              | P2Q                                   |                  |                  |              | P2XL                |                  |                  |              |
| H2Ba         | P2                                     |                  |                  |              | P2Q                                   |                  |                  |              | P2XL                |                  |                  |              |
| Ra           | RHG/RLG                                |                  |                  |              | RHGQ/RLGQ                             |                  |                  |              | RXL                 |                  |                  |              |
| H1Sb         | P1                                     |                  |                  |              | P1Q                                   |                  |                  |              | P1XL                |                  |                  |              |
| H1Bb         | P1                                     | P2               | P1               | P2           | P1Q                                   | P2Q              | P1Q              | P2Q          | P1XL                | P2XL             | P1XL             | P2XL         |
| H2Sb         | P2                                     |                  |                  |              | P2Q                                   |                  |                  |              | P2XL                |                  |                  |              |
| H2Bb         | P2                                     | P1               | P2               | P1           | P2Q                                   | P1Q              | P2Q              | P1Q          | P2XL                | P1XL             | P2XL             | P1XL         |
| Rb           | RHG/RLG                                | (Note 1)         | RHG/RLG          | (Note 1)     | RHGQ/RLGQ                             | (Note 1)         | RHGQ/RLGQ        | (Note 1)     | RXL                 | (Note 1)         | RXL              | (Note 1)     |
| R2ab         | R2HG/R2LG                              |                  |                  |              | R2HGQ/R2LGQ                           |                  |                  |              | R2XL                |                  |                  |              |
| H1Sc         | P1                                     |                  | (Note 1)         |              | P1Q                                   |                  | (Note 1)         |              | P1XL                |                  | (Note 1)         |              |
| H1Bc         | P1                                     |                  | (Note 1)         |              | P1Q                                   |                  | (Note 1)         |              | P1XL                |                  | (Note 1)         |              |
| H2Sc         | P2                                     |                  | (Note 1)         |              | P2Q                                   |                  | (Note 1)         |              | P2XL                |                  | (Note 1)         |              |
| H2Bc         | P2                                     |                  | (Note 1)         |              | P2Q                                   |                  | (Note 1)         |              | P2XL                |                  | (Note 1)         |              |
| Rc           | RHG/RLG                                |                  | (Note 1)         |              | RHGQ/RLGQ                             |                  | (Note 1)         |              | RXL                 |                  | (Note 1)         |              |
| H1Sd         | P1                                     |                  | (Note 1)         |              | P1Q                                   |                  | (Note 1)         |              | P1XL                |                  | (Note 1)         |              |
| H1Bd         | P1                                     | P2               | (Note 1)         |              | P1Q                                   | P2Q              | (Note 1)         |              | P1XL                | P2XL             | (Note 1)         |              |
| H2Sd         | P2                                     |                  | (Note 1)         |              | P2Q                                   |                  | (Note 1)         |              | P2XL                |                  | (Note 1)         |              |
| H2Bd         | P2                                     | P1               | (Note 1)         |              | P2Q                                   | P1Q              | (Note 1)         |              | P2XL                | P1XL             | (Note 1)         |              |
| Rd           | RHG/RLG                                | (Note 1)         | (Note 1)         |              | RHGQ/RLGQ                             | (Note 1)         | (Note 1)         |              | RXL                 | (Note 1)         | (Note 1)         |              |
| R2cd         | R2HG/R2LG                              |                  | (Note 1)         |              | R2HGQ/R2LGQ                           |                  | (Note 1)         |              | R2XL                |                  | (Note 1)         |              |
| SHP (Note 2) | SHP1                                   |                  |                  |              | SHPQ                                  |                  |                  |              | (Note 4)            |                  |                  |              |
| SHD (Note 2) | SHD1                                   |                  |                  |              | SHDQ                                  |                  |                  |              | (Note 5)            |                  |                  |              |

1. This clock should be held at its high level voltage (0 V) or held at +5.0 V for compatibility with TRUESENSE 5.5 micron Interline Transfer CCD family of products.
2. SHP and SHD are the sample clocks for the analog front end (AFE) signal processor.
3. This note intentionally left empty.
4. Use SHPLG for the AFE processing the low gain signal. Use SHPHG for the AFE processing the high gain signal.
5. Use SHDLG for the AFE processing the low gain signal. Use SHDHG for the AFE processing the high gain signal.

**Timing Diagrams**

The charge in the photodiodes is transferred to the VCCD on the rising edge of the +12 V pulse and is completed by the falling edge of the +12 V pulsed on F1T and F1B. During the

time period when F1T and F1B are at +12 V ( $t_{PD}$ ) anti-blooming protection is disabled. The photodiode integration time ends on the falling edge of the +12 V pulse.

*Frame Timing – Quadrant and Dual VOUTa/VOUTc Readout Modes*



NOTE: See Table 20 for pin assignments.

**Figure 32. Frame Timing Diagram Quadrant and Dual VOUTa/VOUTc Readout Modes**



Frame Timing – Single and Dual VOUTa/VOUTb Readout Modes

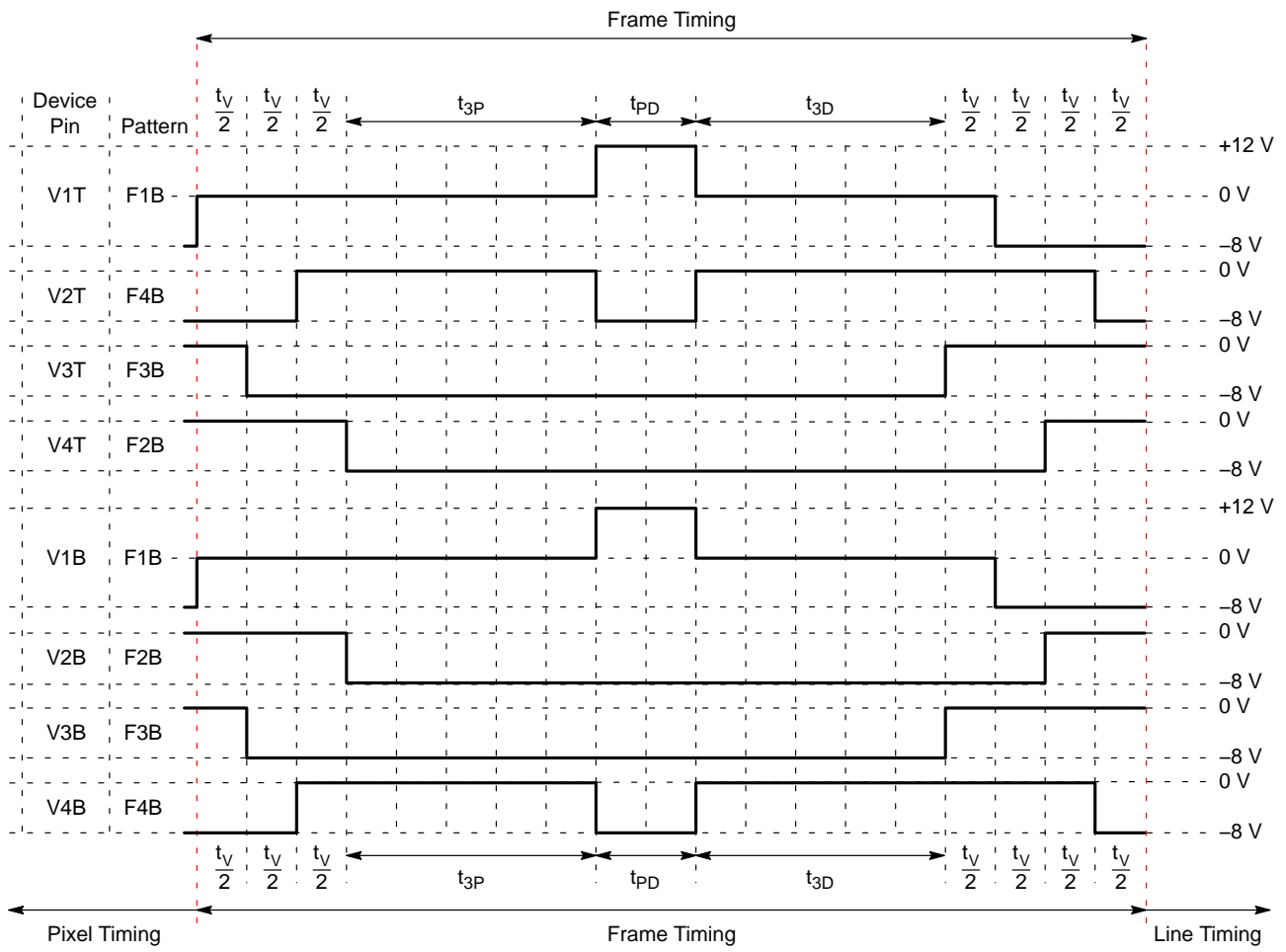

NOTE: See Table 20 for pin assignments.

Figure 33. Frame Timing Diagram Single and Dual VOUTa/VOUTb Readout Modes

Line Timing – Full Resolution – Quadrant and Dual VOUTa/VOUTc Readout Modes

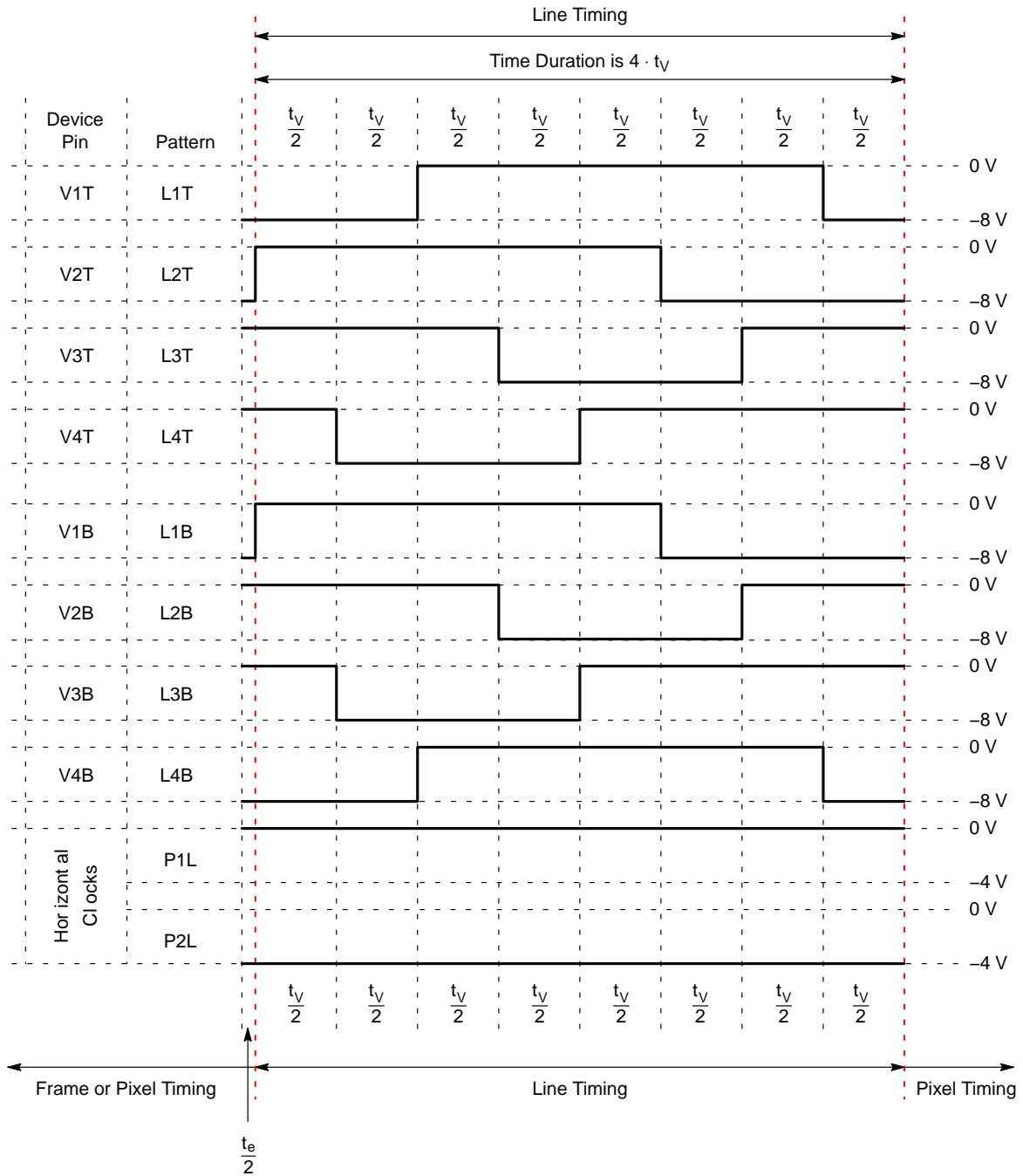

NOTE: See Table 21 for pin assignments.

Figure 34. Line Timing Diagram – Full Resolution – Quadrant and Dual VOUTa/VOUTc Readout Modes

Line Timing – Full Resolution – Single and Dual VOUTa/VOUTb Readout Modes

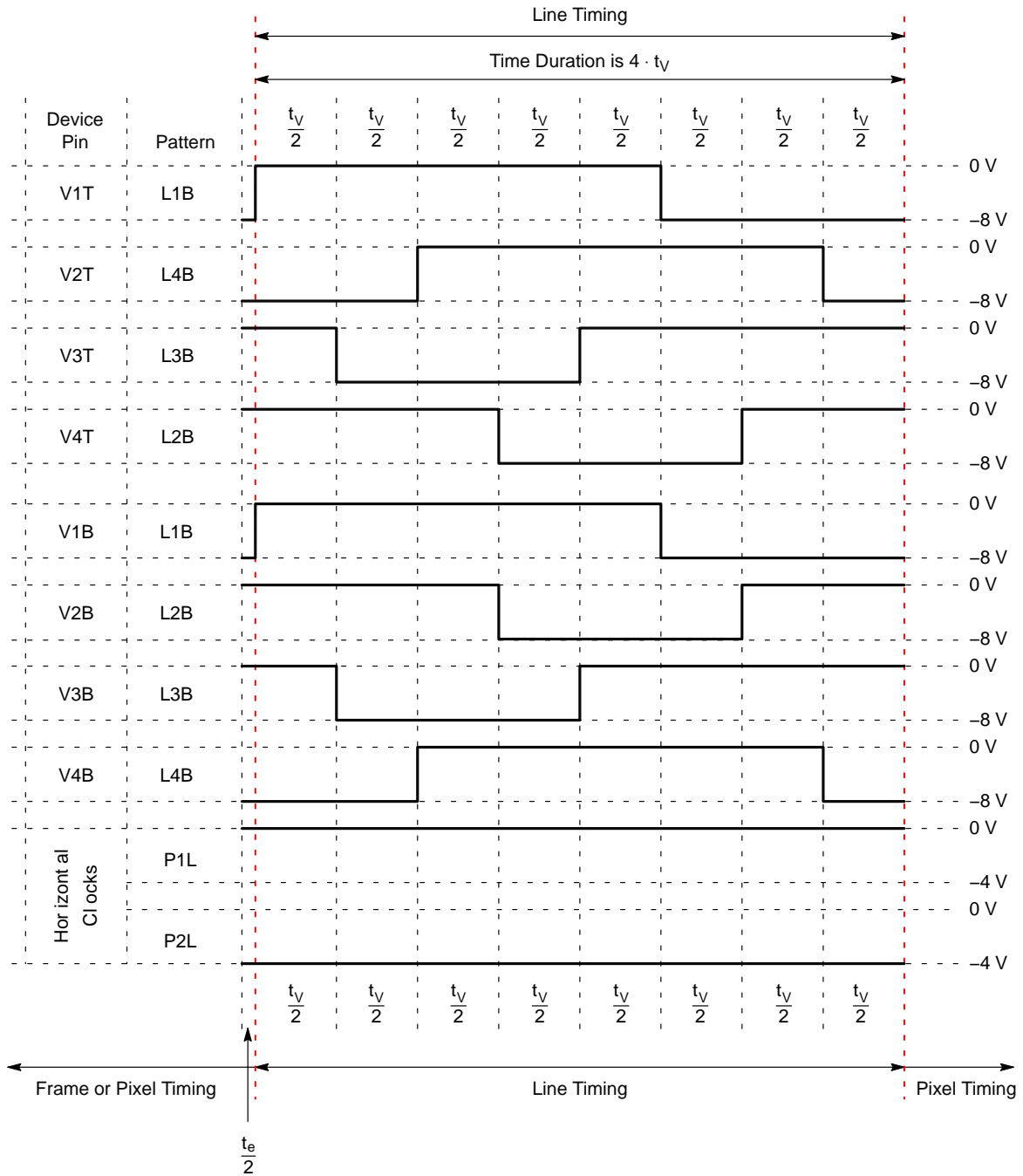

NOTE: See Table 21 for pin assignments.

Figure 35. Line Timing Diagram – Full Resolution – Single and Dual VOUTa/VOUTb Readout Modes

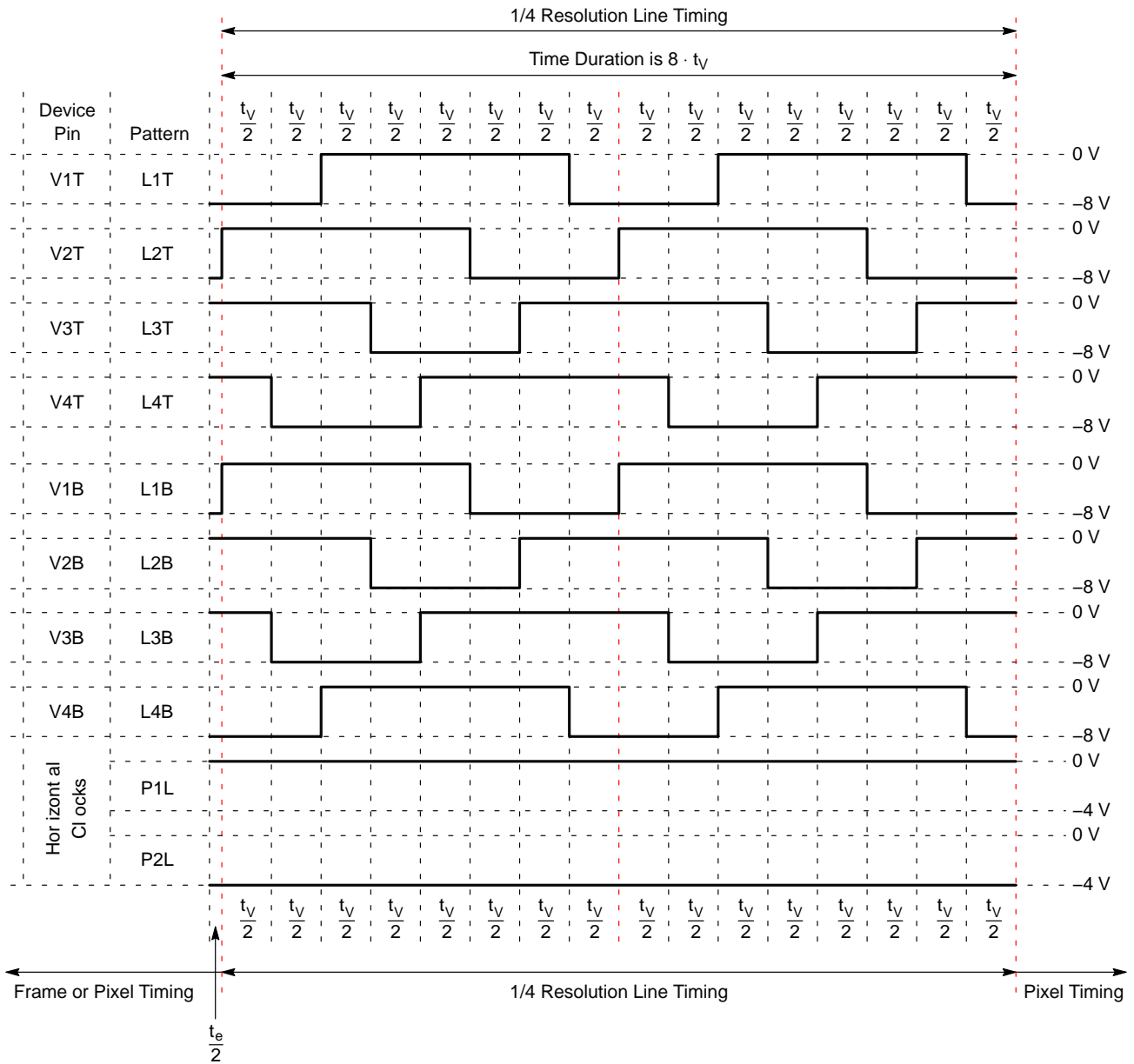

NOTE: See Table 21 for pin assignments.

Figure 36. Line Timing Diagram – 1/4 Resolution – Quadrant and Dual VOUTa/VOUTc Readout Modes

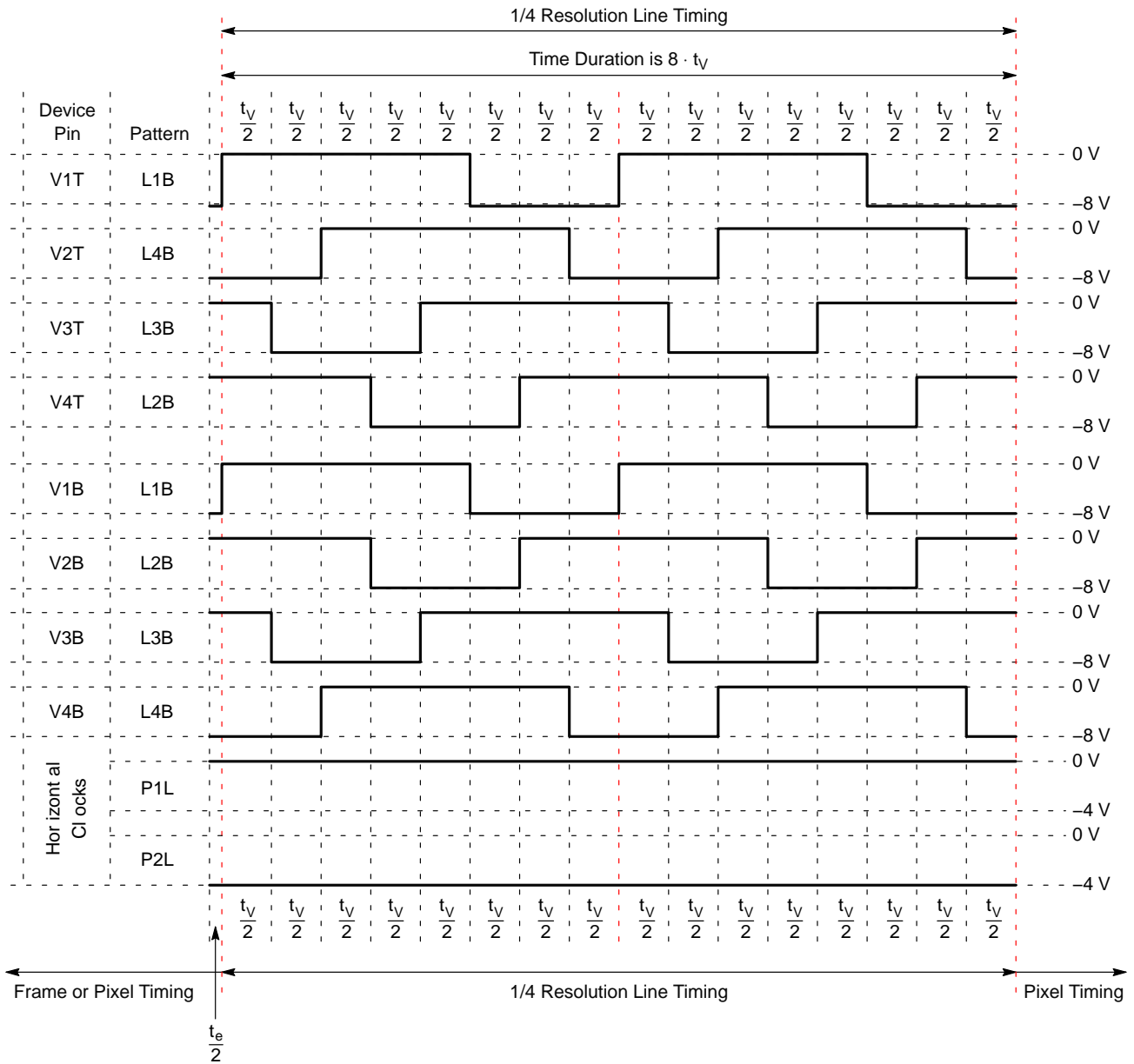

NOTE: See Table 21 for pin assignments.

Figure 37. Line Timing Diagram – 1/4 Resolution – Single and Dual VOUTa/VOUTb Readout Modes

*Electronic Shutter Timing Diagrams*

The electronic shutter pulse can be inserted at the end of any line of the HCCD timing. The HCCD should be empty when the electronic shutter is pulsed. A recommended position for the electronic shutter is just after the last pixel is read out of a line. The VCCD clocks should not resume until at least  $t_V/2$  after the electronic shutter pulse has

finished. The HCCD clocks can be run during the electronic shutter pulse as long as the HCCD does not contain valid image data.

For short exposures less than one line time, the electronic shutter pulse can appear inside the frame timing. Any electronic shutter pulse transition should be  $t_V/2$  away from any VCCD clock transition.

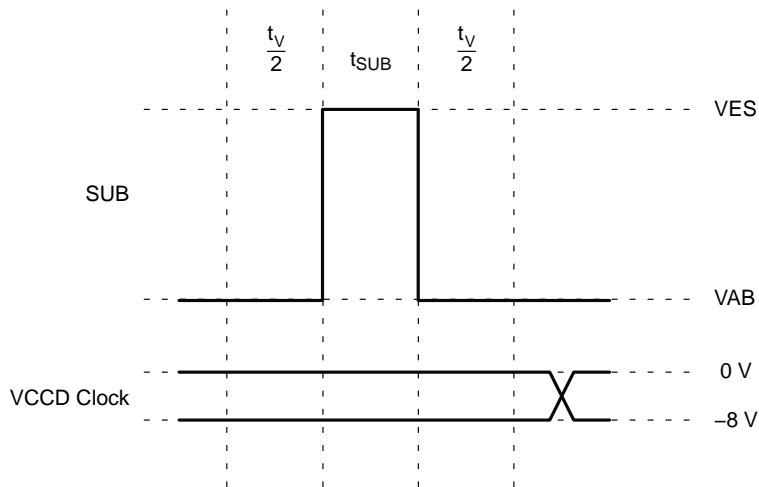

Figure 38. Electronic Shutter Timing

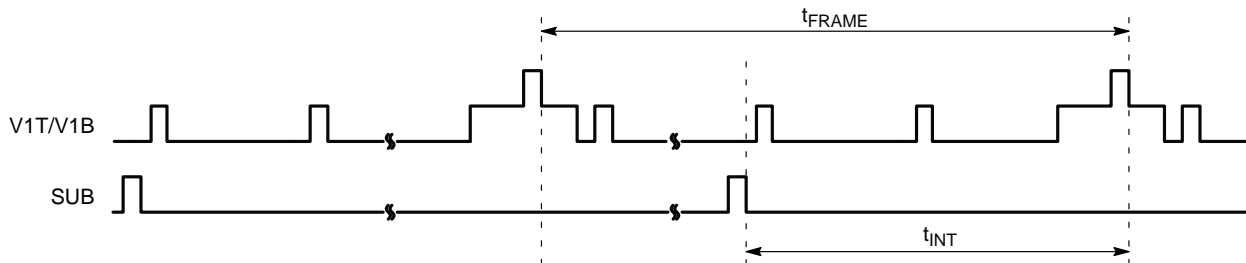

Figure 39. Frame/Electrical Shutter Timing

*Pixel Timing – Full Resolution – High Gain Pixel Timing*

Use this timing to read out every pixel at high gain. If the sensor is to be permanently operated at high gain, the R2ab and R2cd pins can be left floating or set to any DC voltage between +3 V and +5 V. Note the R2ab and R2cd pins are

internally biased to +4.3 V when left floating. The SHP1 and SHD1 pulses indicate where the camera electronics should sample the video waveform. The SHP1 and SHD1 pulses are not applied to the image sensor.

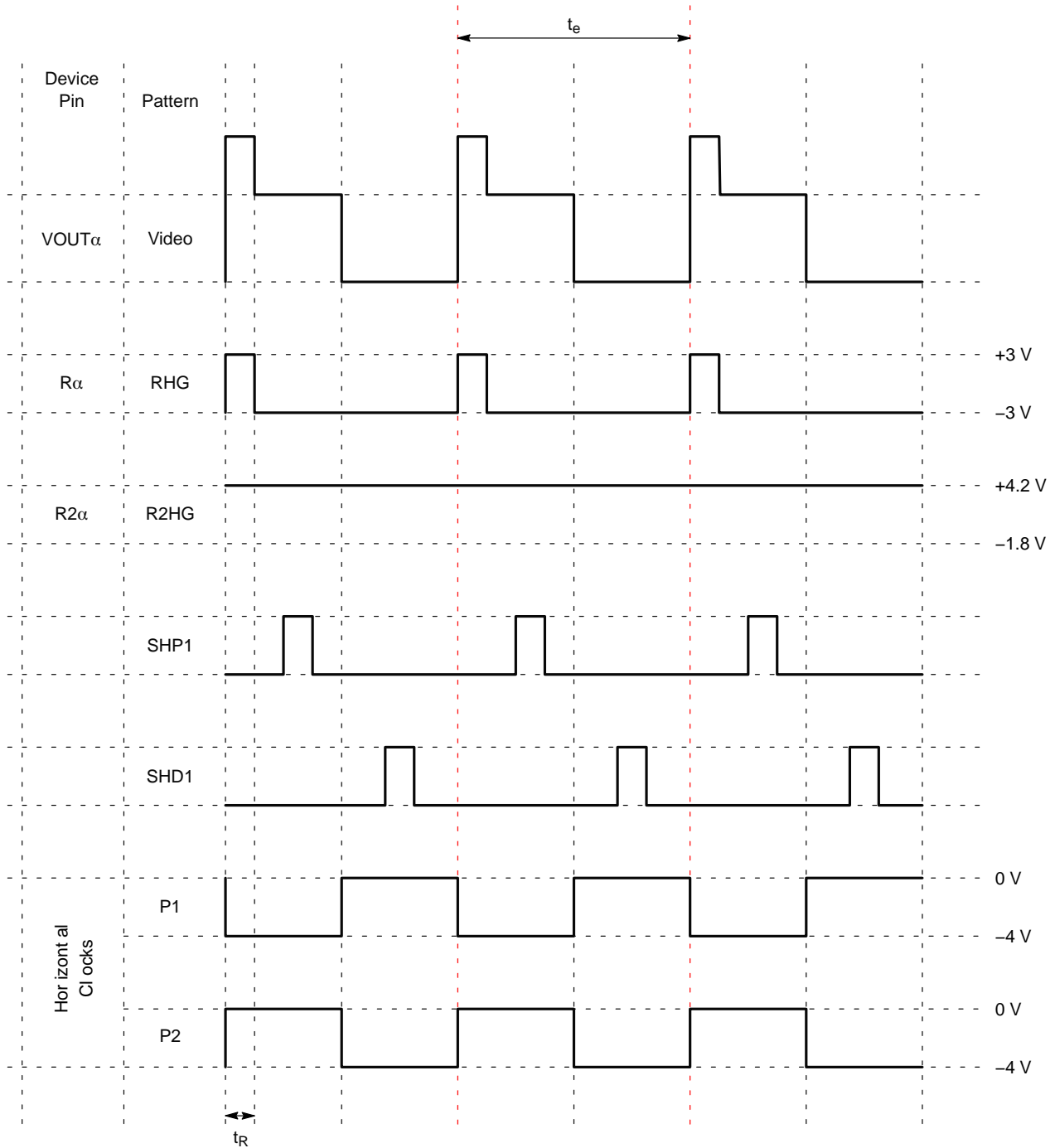

Figure 40. Pixel Timing Diagram – Full Resolution – High Gain

*Pixel Timing – Full Resolution – Low Gain Pixel Timing*

Use this pixel timing to read out every pixel at low gain. If the sensor is to be permanently operated at low gain, the Ra, Rb, Rc and Rd pins should be set to any DC voltage

between +3 V and +5 V. The SHP1 and SHD1 pulses indicate where the camera electronics should sample the video waveform. The SHP1 and SHD1 pulses are not applied to the image sensor.

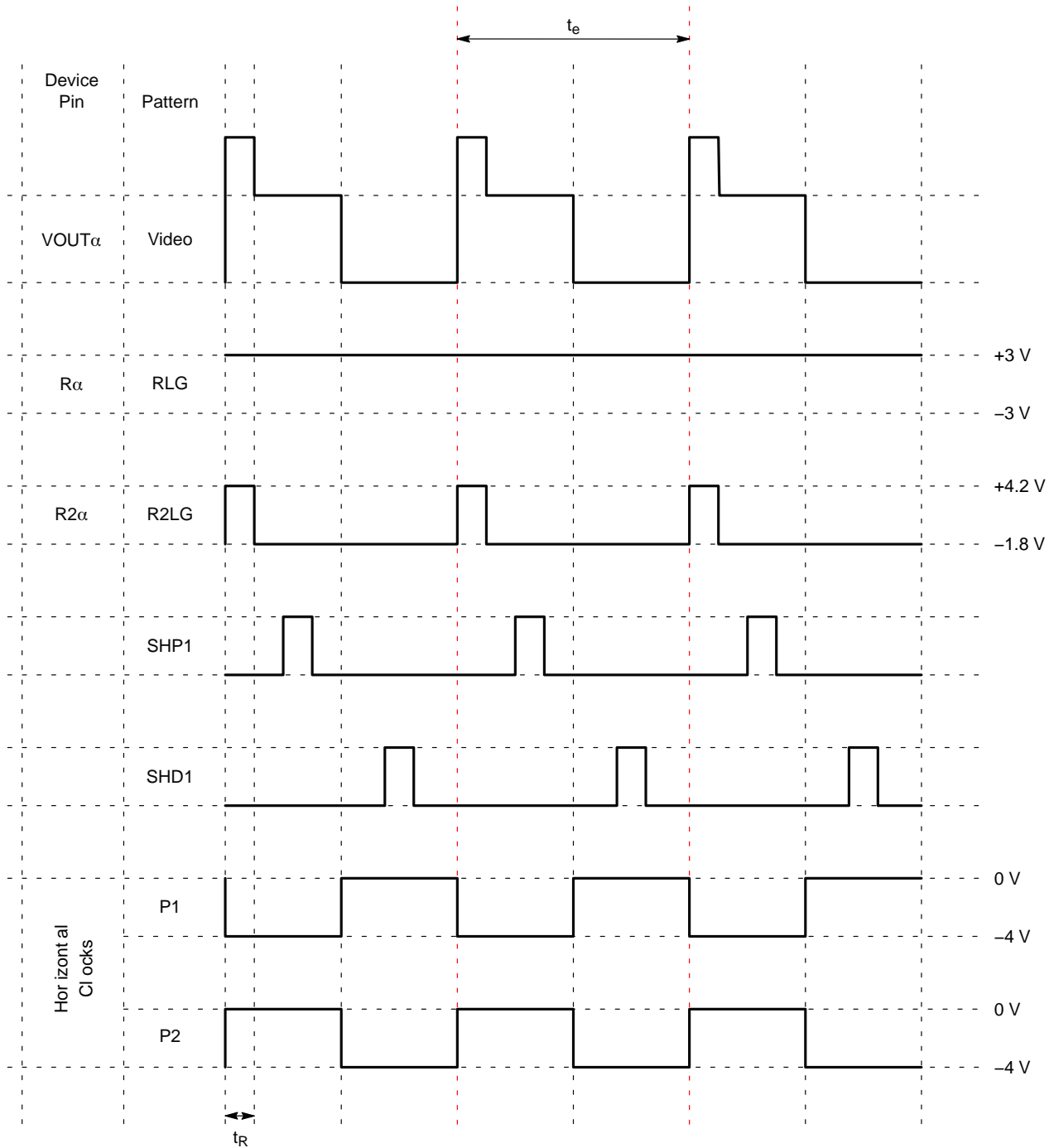

Figure 41. Pixel Timing Diagram – Full Resolution – Low Gain



*Pixel Timing – 1/4 Resolution – High Gain Pixel Timing*

Use this timing to read out two pixels summed on the output amplifier sense node at high gain. If the sensor is to be permanently operated at high gain, the R2ab and R2cd pins can be left floating or set to any DC voltage between +3 V and +5 V. Note the R2ab and R2cd pins are internally biased to +4.3 V when left floating. The SHPQ and SHDQ pulses indicate where the camera electronics should sample

the video waveform. The SHPQ and SHDQ pulses are not applied to the image sensor.

The Ra, Rb, Rc, and Rd pins are pulsed at half the frequency of the horizontal CCD clocks. This causes two pixels to be summed on the output amplifier sense node. The SHPQ and SHDQ clocks are also half the frequency of the horizontal CCD clocks.

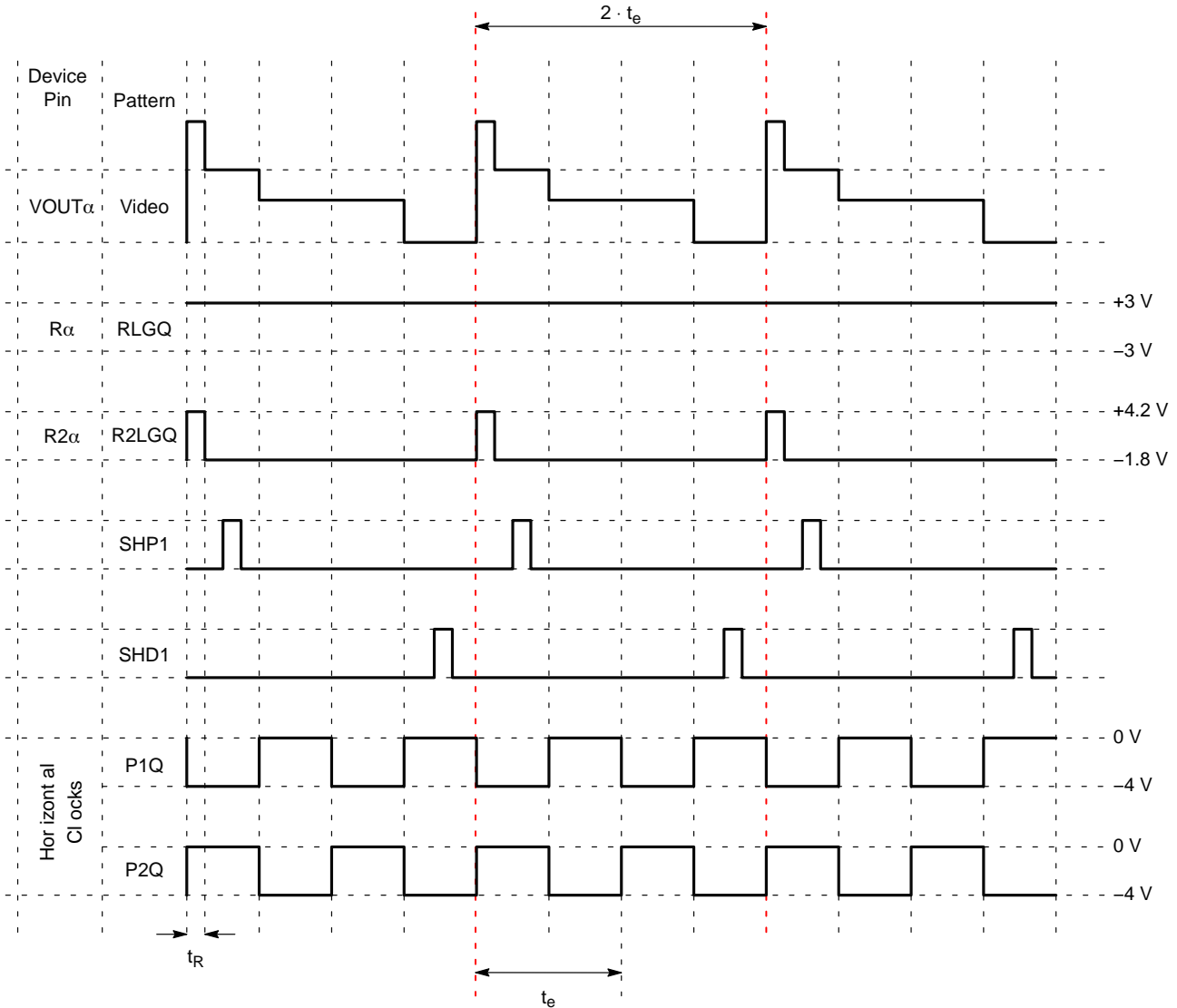

Figure 42. Pixel Timing Diagram – 1/4 Resolution – High Gain

*Pixel Timing – 1/4 Resolution – Low Gain Pixel Timing*

Use this timing to read out two pixels summed on the output amplifier sense node at low gain. If the sensor is to be permanently operated at low gain, the Ra, Rb, Rc and Rd pins can be set to any DC voltage between +3 V and +5 V. The SHPQ and SHDQ pulses indicate where the camera electronics should sample the video waveform. The SHPQ and SHDQ pulses are not applied to the image sensor.

The R2ab and R2cd pins are pulsed at half the frequency of the horizontal CCD clocks. This causes two pixels to be summed on the output amplifier sense node. The SHPQ and SHDQ clocks are also half the frequency of the horizontal CCD clocks.



**Figure 43. Pixel Timing Diagram – 1/4 Resolution – Low Gain**

*XLDR Pixel Timing*

To operate the sensor in extended linear dynamic range (XLDR) mode, the following pixel timing should be used. This mode requires two sets of analog front end (AFE) signal processing electronic units for each output. As shown in Figure 44 one AFE samples the pixel at low gain (SHPLG and SHDLG) and the other AFE samples the pixel at high gain (SHPHG and SHDHG).

Two HCCD pixels are summed on the output amplifier node to obtain enough charge to fully use the 82 dB range of the XLDR timing. Combined with two-line VCCD summing, a total of 160,000 electrons of signal ( $4 \times 40,000$ )

can be sampled with 12 electrons or less noise. Note that a linear dynamic range of 82 dB is very large. Ensure that the camera optics is capable of focusing an 82 dB dynamic range image on the sensor. Lens flare caused by inexpensive optics or even dust on the lens will limit the dynamic range.

The timing shown in Figure 46 shows the HCCD not being clocked at a constant frequency. If the HCCD cannot be clocked at a variable frequency, then the HCCD may be clocked at a constant frequency (Figure 45) at the expense of about 33% slower frame rate.



Figure 44. XLDR Timing – AFE Connections Block Diagram

Pixel Timing – 1/4 Resolution – XLDR Pixel Timing – Constant HCCD Timing



Figure 45. Pixel Timing Diagram – 1/4 Resolution – XLDR – Constant HCCD Timing

Pixel Timing – 1/4 Resolution – XLDR Pixel Timing – Variable HCCD Timing

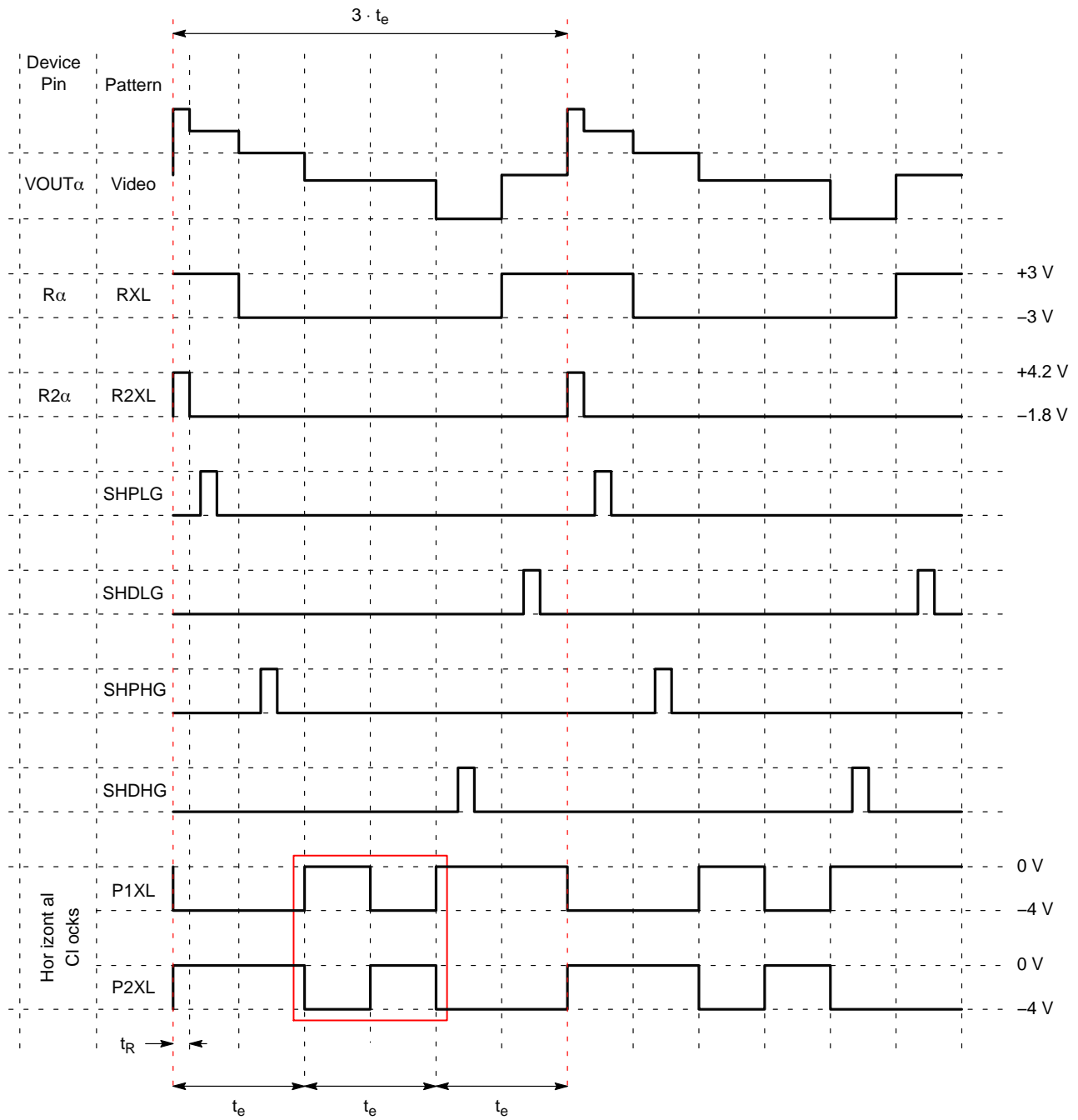

Figure 46. Pixel Timing Diagram – 1/4 Resolution – XLDR – Variable HCCD Timing

VCCD Clock Edge Alignment

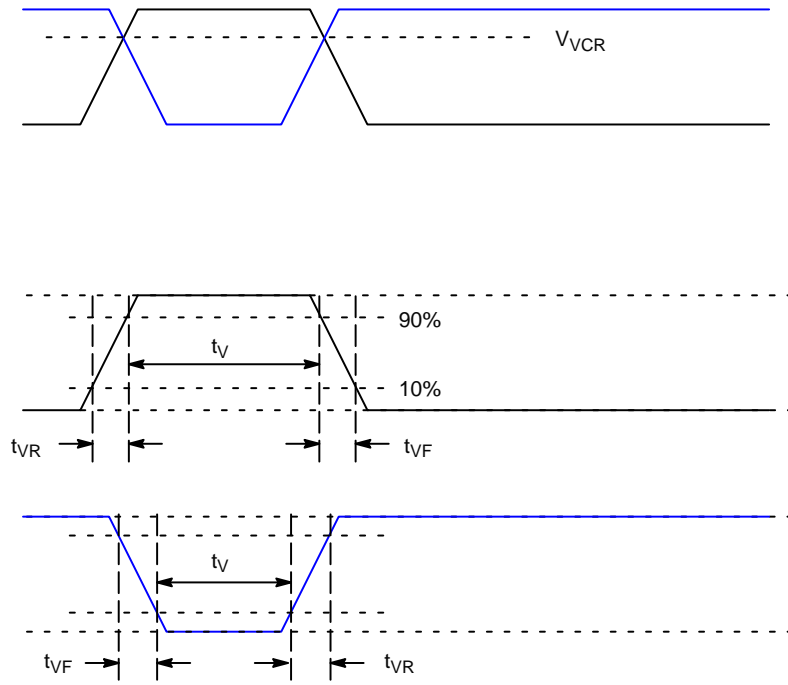
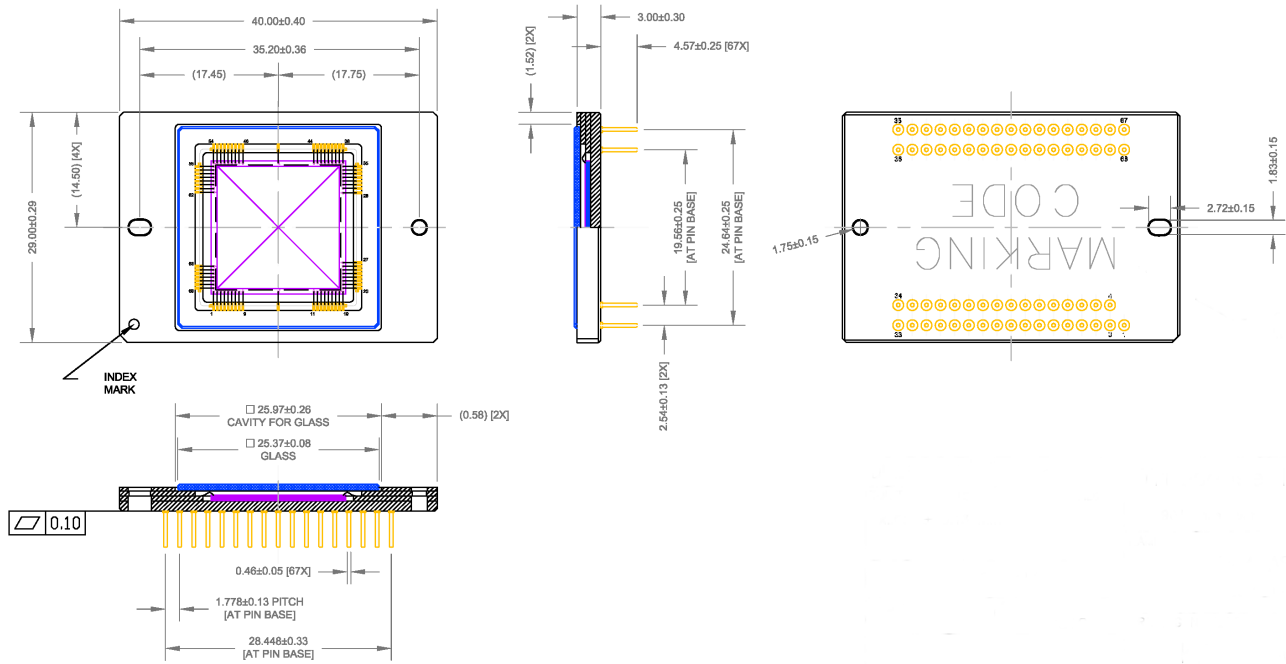

Figure 47. VCCD Clock Rise Time, Fall Time and Edge Alignment

MECHANICAL INFORMATION

Completed Assembly



Notes:

1. See Ordering Information for marking code.
2. No materials to interfere with clearance through guide holes.
3. Units: mm.

Figure 48. Completed Assembly (1 of 2)

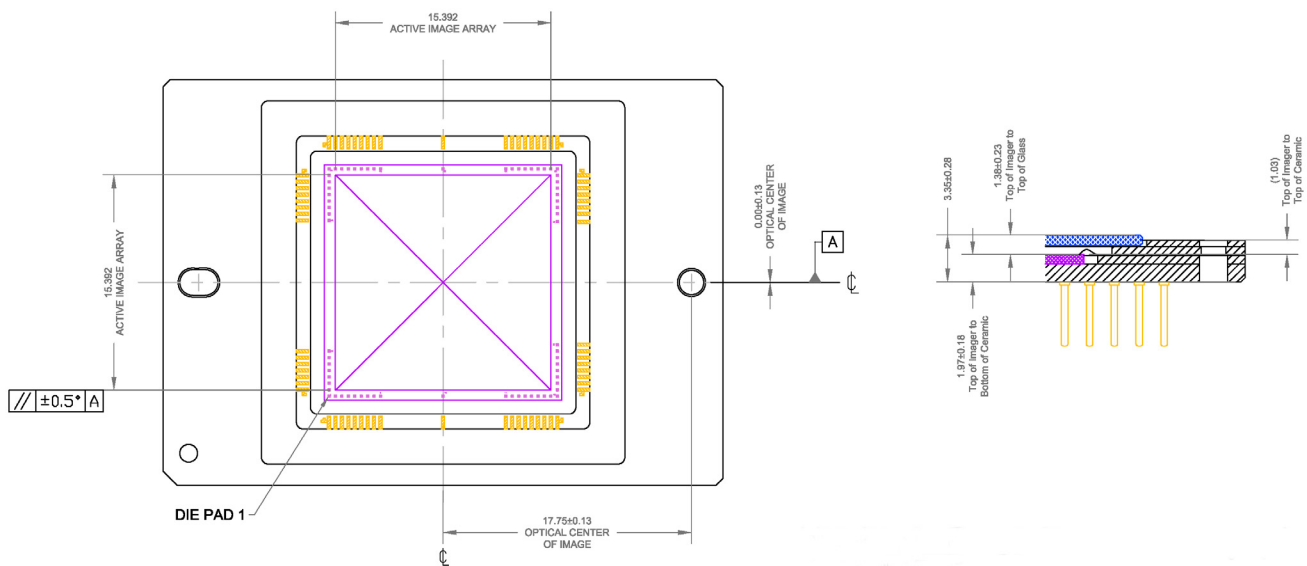

Notes:

1. Optical center of image is nominally at the package center.
2. Units: mm.

Figure 49. Completed Assembly (2 of 2)

# KAI-04070

## Cover Glass

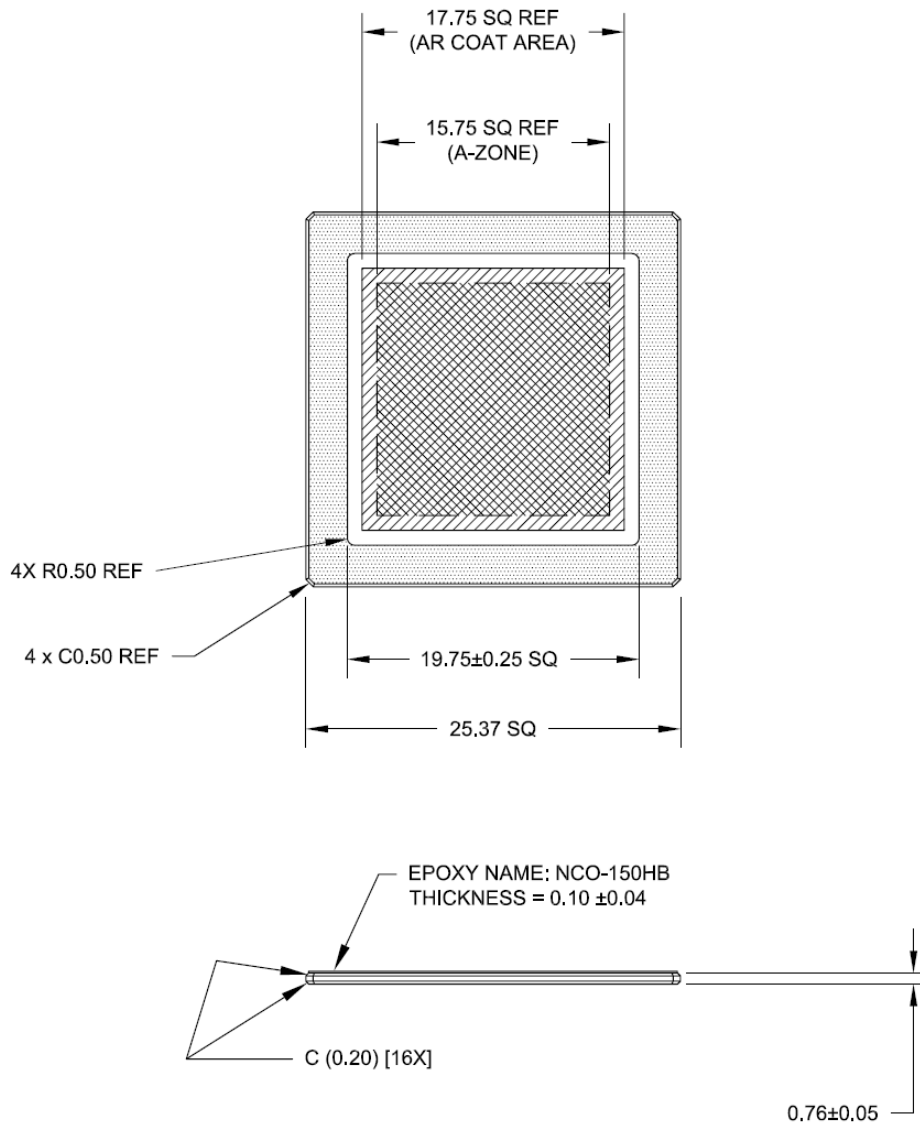

### Notes:

1. Substrate = Schott D263T eco.
2. Dust, Scratch, Inclusion Specification: 10  $\mu\text{m}$  maximum size in Zone A.
3. MAR coated both sides.
4. Spectral Transmission:
  - a. T > 98.0% 420–435 nm
  - b. T > 99.2% 435–630 nm
  - c. T > 98.0% 630–680 nm
5. Units: mm.

Figure 50. Cover Glass



Cover Glass Transmission

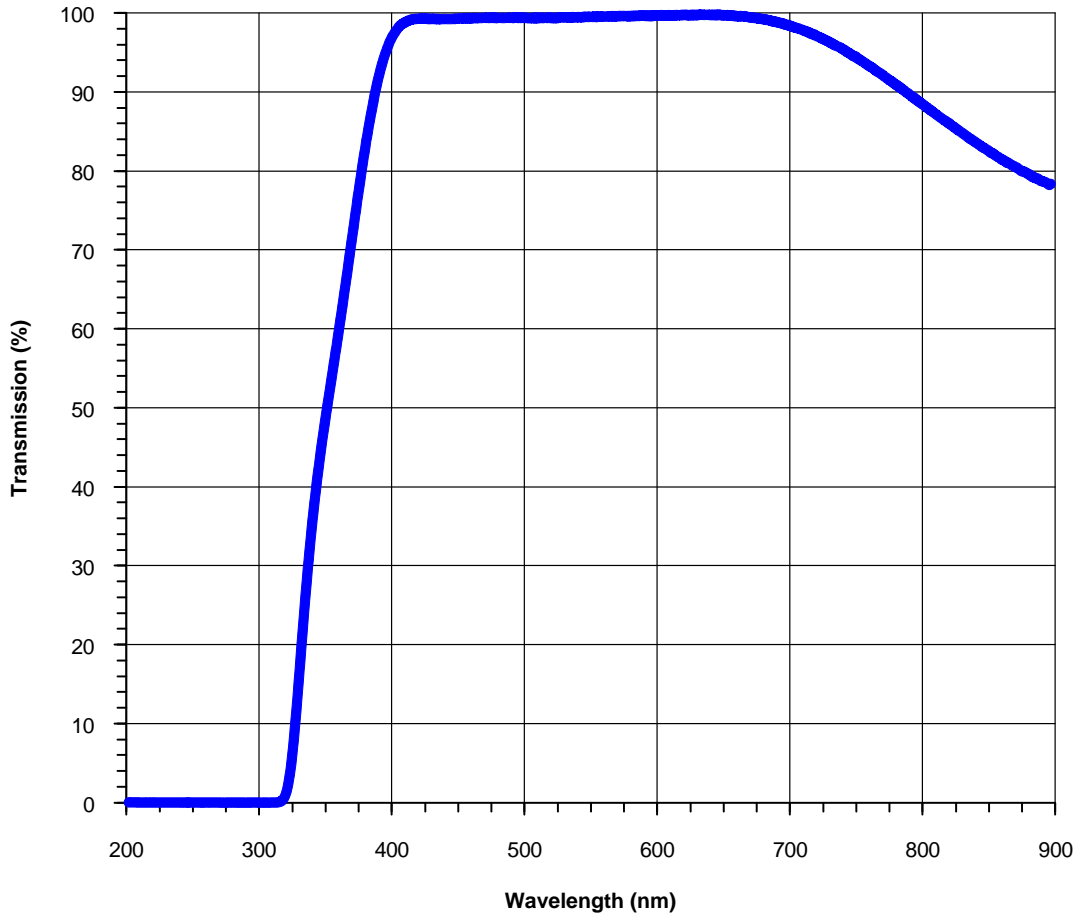

Figure 51. Cover Glass Transmission

## REFERENCES

For information on ESD and cover glass care and cleanliness, please download the *Image Sensor Handling and Best Practices* Application Note (AN52561/D) from [www.onsemi.com](http://www.onsemi.com).

For information on environmental exposure, please download the *Using Interline CCD Image Sensors in High Intensity Lighting Conditions* Application Note (AND9183/D) from [www.onsemi.com](http://www.onsemi.com).

For information on soldering recommendations, please download the *Soldering and Mounting Techniques Reference Manual* (SOLDERRM/D) from [www.onsemi.com](http://www.onsemi.com).

For quality and reliability information, please download the *Quality & Reliability Handbook* (HBD851/D) from [www.onsemi.com](http://www.onsemi.com).

For information on device numbering and ordering codes, please download the *Device Nomenclature* technical note (TND310/D) from [www.onsemi.com](http://www.onsemi.com).

For information on Standard terms and Conditions of Sale, please download [Terms and Conditions](http://www.onsemi.com) from [www.onsemi.com](http://www.onsemi.com).

ON Semiconductor and the  are registered trademarks of Semiconductor Components Industries, LLC (SCILLC) or its subsidiaries in the United States and/or other countries. SCILLC owns the rights to a number of patents, trademarks, copyrights, trade secrets, and other intellectual property. A listing of SCILLC's product/patent coverage may be accessed at [www.onsemi.com/site/pdf/Patent-Marking.pdf](http://www.onsemi.com/site/pdf/Patent-Marking.pdf). SCILLC reserves the right to make changes without further notice to any products herein. SCILLC makes no warranty, representation or guarantee regarding the suitability of its products for any particular purpose, nor does SCILLC assume any liability arising out of the application or use of any product or circuit, and specifically disclaims any and all liability, including without limitation special, consequential or incidental damages. "Typical" parameters which may be provided in SCILLC data sheets and/or specifications can and do vary in different applications and actual performance may vary over time. All operating parameters, including "Typicals" must be validated for each customer application by customer's technical experts. SCILLC does not convey any license under its patent rights nor the rights of others. SCILLC products are not designed, intended, or authorized for use as components in systems intended for surgical implant into the body, or other applications intended to support or sustain life, or for any other application in which the failure of the SCILLC product could create a situation where personal injury or death may occur. Should Buyer purchase or use SCILLC products for any such unintended or unauthorized application, Buyer shall indemnify and hold SCILLC and its officers, employees, subsidiaries, affiliates, and distributors harmless against all claims, costs, damages, and expenses, and reasonable attorney fees arising out of, directly or indirectly, any claim of personal injury or death associated with such unintended or unauthorized use, even if such claim alleges that SCILLC was negligent regarding the design or manufacture of the part. SCILLC is an Equal Opportunity/Affirmative Action Employer. This literature is subject to all applicable copyright laws and is not for resale in any manner.

## PUBLICATION ORDERING INFORMATION

### LITERATURE FULFILLMENT:

Literature Distribution Center for ON Semiconductor  
P.O. Box 5163, Denver, Colorado 80217 USA  
**Phone:** 303-675-2175 or 800-344-3860 Toll Free USA/Canada  
**Fax:** 303-675-2176 or 800-344-3867 Toll Free USA/Canada  
**Email:** [orderlit@onsemi.com](mailto:orderlit@onsemi.com)

**N. American Technical Support:** 800-282-9855 Toll Free  
USA/Canada  
**Europe, Middle East and Africa Technical Support:**  
Phone: 421 33 790 2910  
**Japan Customer Focus Center**  
Phone: 81-3-5817-1050

**ON Semiconductor Website:** [www.onsemi.com](http://www.onsemi.com)

**Order Literature:** <http://www.onsemi.com/orderlit>

For additional information, please contact your local Sales Representative

Компания «Life Electronics» занимается поставками электронных компонентов импортного и отечественного производства от производителей и со складов крупных дистрибьюторов Европы, Америки и Азии.

С конца 2013 года компания активно расширяет линейку поставок компонентов по направлению коаксиальный кабель, кварцевые генераторы и конденсаторы (керамические, пленочные, электролитические), за счёт заключения дистрибьюторских договоров

Мы предлагаем:

- Конкурентоспособные цены и скидки постоянным клиентам.
- Специальные условия для постоянных клиентов.
- Подбор аналогов.
- Поставку компонентов в любых объемах, удовлетворяющих вашим потребностям.
- Приемлемые сроки поставки, возможна ускоренная поставка.
- Доставку товара в любую точку России и стран СНГ.
- Комплексную поставку.
- Работу по проектам и поставку образцов.
- Формирование склада под заказчика.
- Сертификаты соответствия на поставляемую продукцию (по желанию клиента).
- Тестирование поставляемой продукции.
- Поставку компонентов, требующих военную и космическую приемку.
- Входной контроль качества.
- Наличие сертификата ISO.

В составе нашей компании организован Конструкторский отдел, призванный помогать разработчикам, и инженерам.

Конструкторский отдел помогает осуществить:

- Регистрацию проекта у производителя компонентов.
- Техническую поддержку проекта.
- Защиту от снятия компонента с производства.
- Оценку стоимости проекта по компонентам.
- Изготовление тестовой платы монтаж и пусконаладочные работы.



Тел: +7 (812) 336 43 04 (многоканальный)

Email: [org@lifeelectronics.ru](mailto:org@lifeelectronics.ru)