

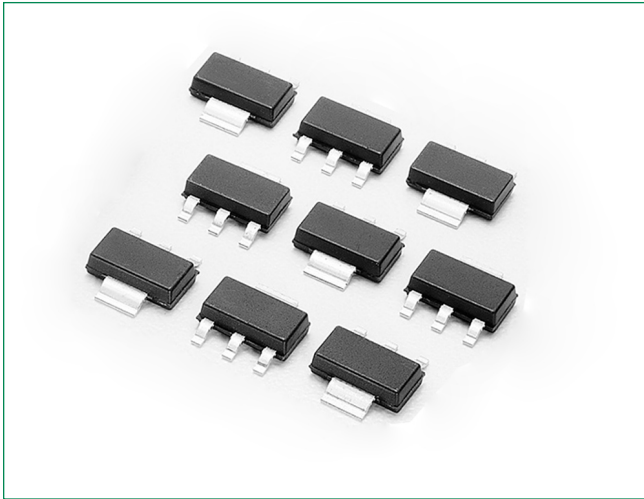

MAC08BT1, MAC08MT1



Description

Designed for high volume, low cost, industrial and consumer applications such as motor control; process control; temperature, light and speed control.

Features

- Sensitive Gate Trigger Current in Four Trigger Modes
- Blocking Voltage to 600 Volts
- Glass Passivated Surface for Reliability and Uniformity
- Surface Mount Package
- Pb-Free Packages are Available

Pin Out

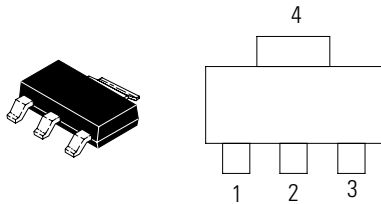

Functional Diagram

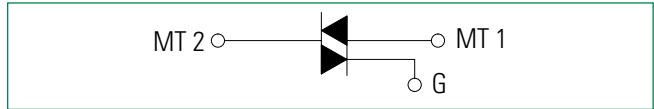

Additional Information



Datasheet



Resources



Samples

Maximum Ratings ($T_J = 25^\circ\text{C}$ unless otherwise noted)

Rating	Symbol	Value	Unit
Peak Repetitive Off-State Voltage (Note 1) (Gate Open, Sine Wave 50 to 60 Hz, $T_J = -40^\circ$ to 110°C)	V_{DRM}^* V_{RRM}	200 600	V
On-State RMS Current (Full Cycle Sine Wave, 60 Hz, $T_C = 80^\circ\text{C}$)	$I_{\text{T (RMS)}}$	0.8	A
Peak Non-Repetitive Surge Current (One Full Cycle Sine Wave, 60 Hz, $T_C = 25^\circ\text{C}$)	I_{TSM}	8.0	A
Circuit Fusing Consideration ($t = 8.3$ msec)	I^2t	0.4	A ² sec
Peak Gate Power (Pulse Width ≤ 10 μsec , $T_C = 80^\circ\text{C}$)	P_{GM}	5.0	W
Average Gate Power ($t = 8.3$ msec, $T_C = 80^\circ\text{C}$)	$P_{\text{G(AV)}}$	0.1	W
Operating Junction Temperature Range	T_J	-40 to +110	$^\circ\text{C}$
Storage Temperature Range	T_{stg}	-40 to +150	$^\circ\text{C}$

Stresses exceeding Maximum Ratings may damage the device. Maximum Ratings are stress ratings only. Functional operation above the Recommended Operating Conditions is not implied. Extended exposure to stresses above the Recommended Operating Conditions may affect device reliability.

- V_{DRM} and V_{RRM} for all types can be applied on a continuous basis. Ratings apply for zero or negative gate voltage; however, positive gate voltage shall not be applied concurrent with negative potential on the anode. Blocking voltages shall not be tested with a constant current source such that the voltage ratings of the devices are exceeded.

Thermal Characteristics

Rating	Symbol	Value	Unit
Thermal Resistance, Junction-to-Ambient PCB Mounted per Figure 1	$R_{\theta\text{JA}}$	156	$^\circ\text{C/W}$

- These ratings are applicable when surface mounted on the minimum pad sizes recommended.
- 1/8" from case for 10 seconds.

Electrical Characteristics - OFF ($T_C = 25^\circ\text{C}$ unless otherwise noted)

Characteristic	Symbol	Min	Typ	Max	Unit
†Peak Repetitive Blocking Current ($V_{\text{AK}} = V_{\text{DRM}} = V_{\text{RRM}}$; Gate Open)	I_{DRM}^* I_{RRM}	-	-	10	μA
		-	-	200	mA

Electrical Characteristics - ON ($T_C = 25^\circ\text{C}$ unless otherwise noted; Electricals apply in both directions)

Characteristic	Symbol	Min	Typ	Max	Unit
Peak On-State Voltage (Note 2) ($I_{\text{TM}} = \pm 1.1$ A)	V_{TM}	-	-	1.9	V
Gate Trigger Current (Continuous dc) ($V_D = 12$ V, $R_L = 100$ Ω)	I_{GT}	-	-	10	mA
Holding Current ($V_D = 12$ V, Gate Open, Initiating Current = ± 20 mA)	I_{H}	-	-	5.0	mA
Gate Trigger Voltage (Continuous dc) ($V_D = 12$ V, $R_L = 100$ Ω)	V_{GT}	-	-	2.0	V

- Pulse Test: Pulse Width ≤ 2.0 ms, Duty Cycle $\leq 2\%$.

Dynamic Characteristics

Characteristic	Symbol	Min	Typ	Max	Unit
Critical Rate of Rise of Commutation Voltage ($f = 250$ Hz, $I_{\text{TM}} = 1.0$ A, Commutating $di/dt = 1.5$ A/mS On-State Current Duration = 2.0 mS, $V_{\text{DRM}} = 200$ V, Gate Unenergized, $T_C = 110^\circ\text{C}$, Gate Source Resistance = 150 Ω , See Figure 10)	(di/dt)c	1.5	-	-	A/ms
Critical Rate of Rise of Off-State Voltage ($V_D = 0.67 \times V_{\text{DRM}}$, Exponential Waveform, Gate Open, $T_J = 110^\circ\text{C}$)	dV/dt	10	-	-	V/ μs

Voltage Current Characteristic of SCR

Symbol	Parameter
V_{DRM}	Peak Repetitive Forward Off State Voltage
I_{DRM}	Peak Forward Blocking Current
V_{RRM}	Peak Repetitive Reverse Off State Voltage
I_{RRM}	Peak Reverse Blocking Current
V_{TM}	Maximum On State Voltage
I_H	Holding Current

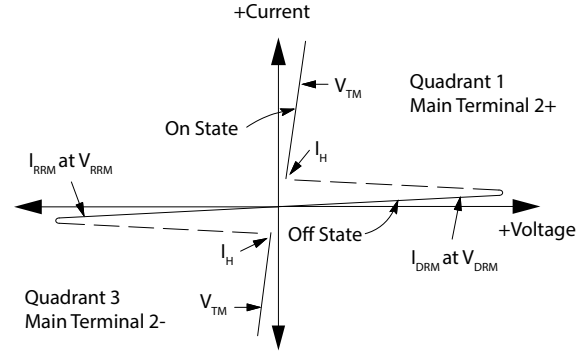

Quadrant Definitions for a Triac

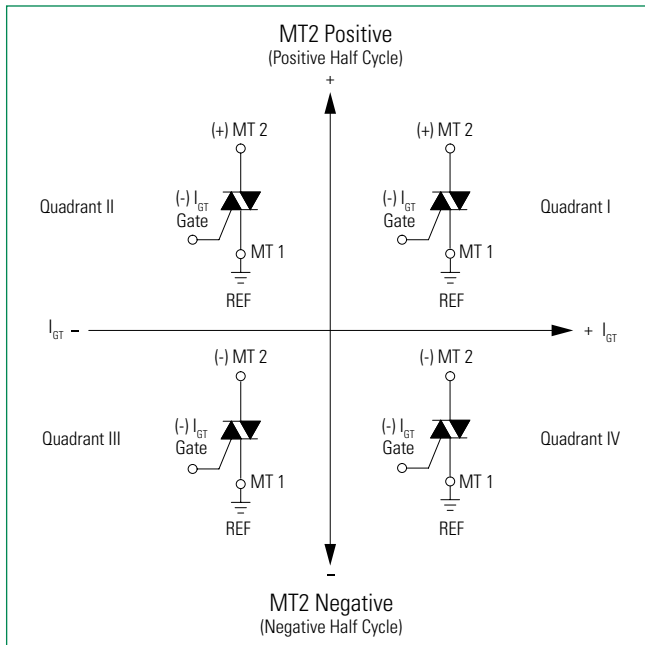

All Polarities are referenced to MT1.
With in-phase signals (using standard AC lines) quadrants I and III are used

Figure 1. PCB for Thermal Impedance and Power Testing of SOT-223

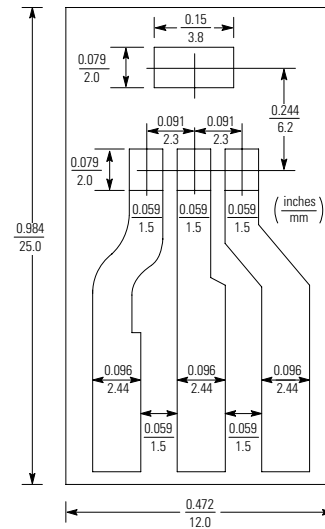

**BOARD MOUNTED VERTICALLY IN CINCH 8840 EDGE CONNECTOR.
BOARD THICKNESS = 65 MIL., FOIL THICKNESS = 2.5 MIL.
MATERIAL: G10 FIBERGLASS BASE EPOXY**

Figure 2. On-State Characteristics

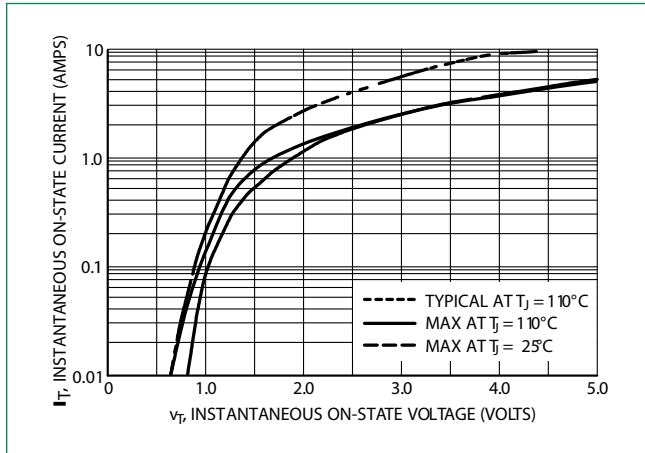

Figure 3. Junction to Ambient Thermal Resistance vs. Copper Tab Area

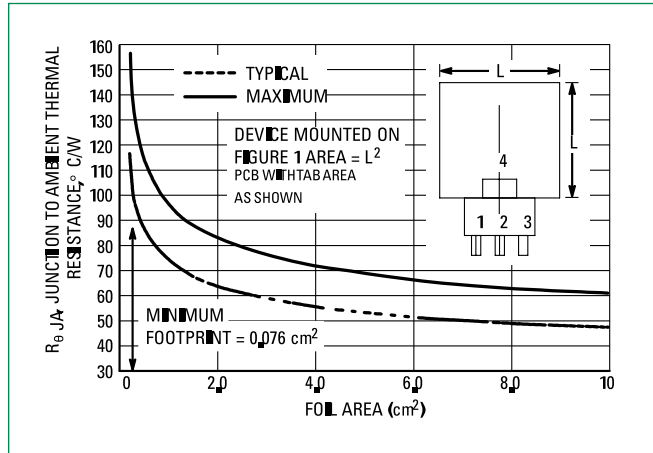

Figure 4. Current Derating, Minimum Pad Size Reference: Ambient Temperature

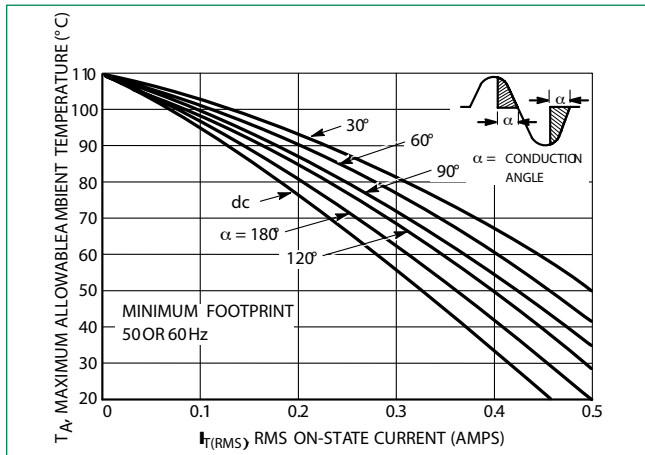

Figure 5. Current Derating, 1.0 cm Square Pad Reference: Ambient Temperature

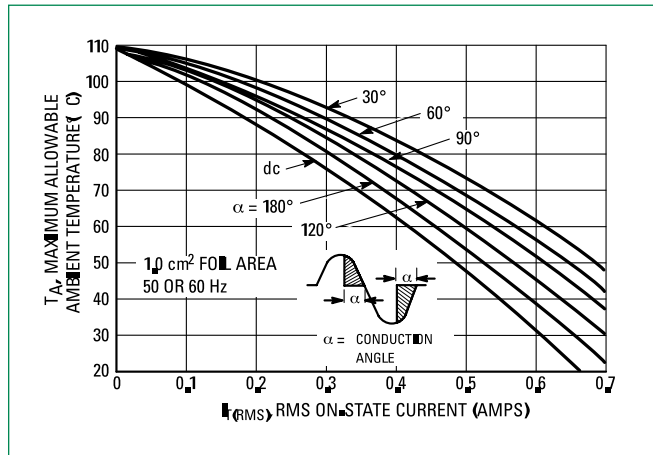

Figure 6. Current Derating, 2.0 cm Square Pad Reference: Ambient Temperature

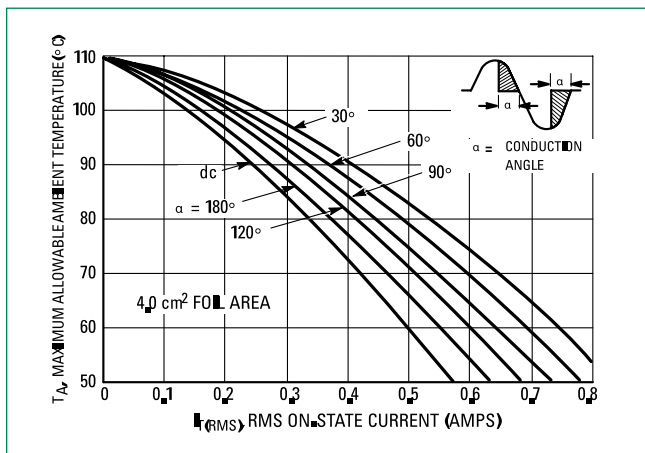

Figure 7. Current Derating Reference: MT2 Tab

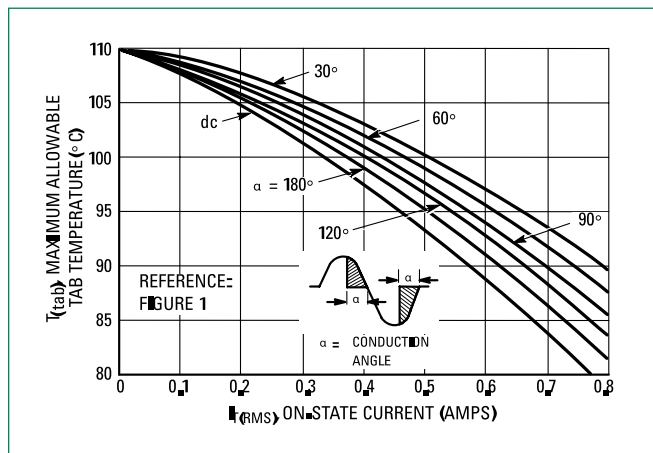

Figure 8. Power Dissipation

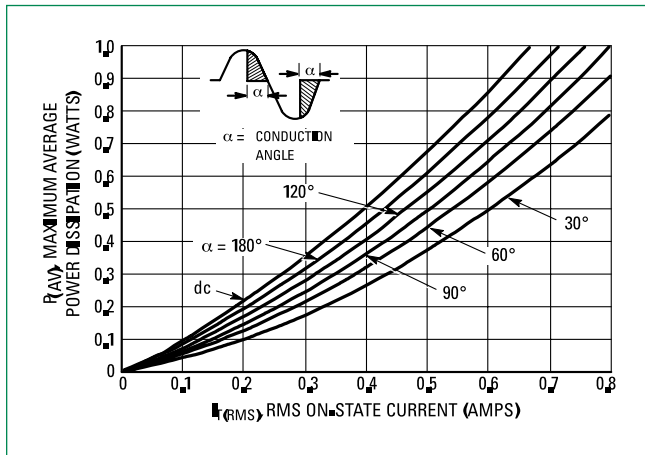

Figure 9. Thermal Response, Device Mounted on Figure 1 Printed Circuit Board

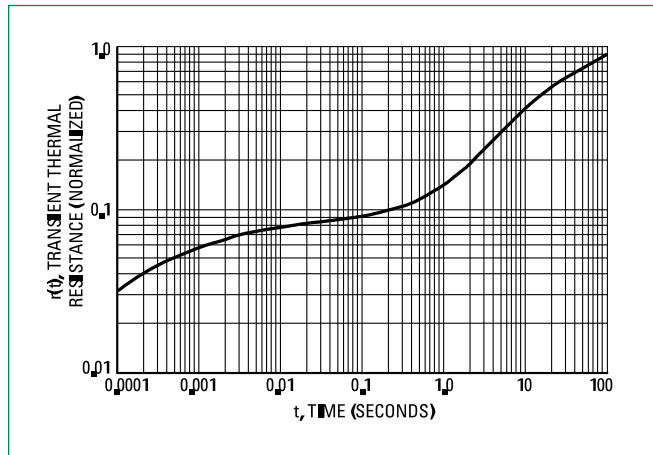

Figure 10. Simplified Test Circuit to Measure the Critical Rate of Rise of Commutating Current (di/dt)

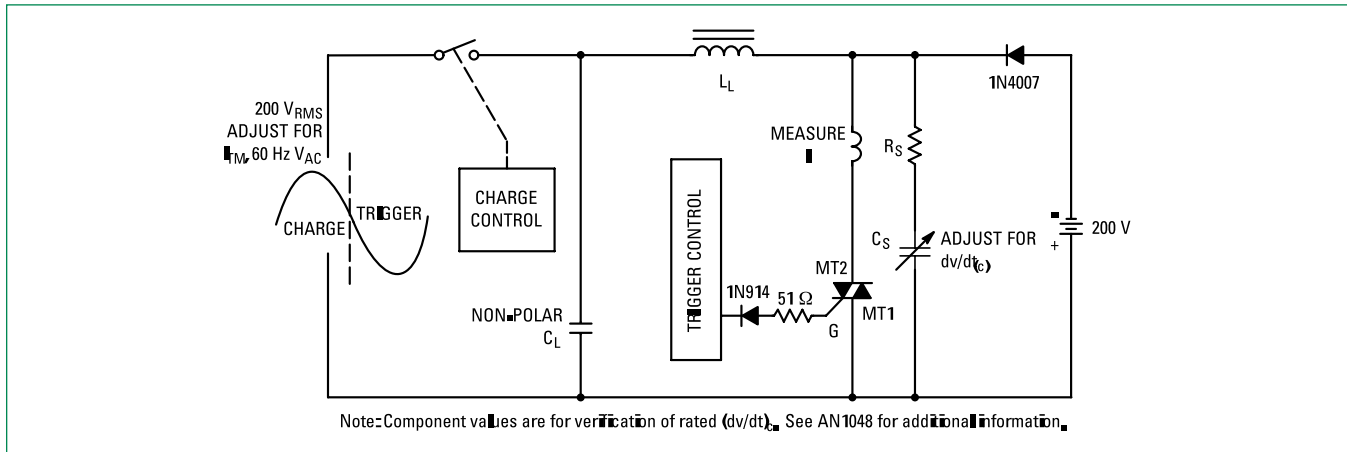

Figure 11. Typical Commutating dv/dt versus Current Crossing Rate and Junction Temperature

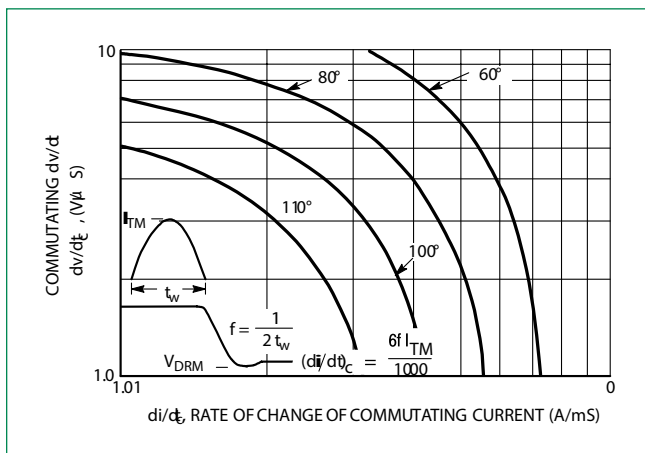

Figure 12. Typical Commutating dv/dt versus Junction Temperature at 0.8 Amps RMS

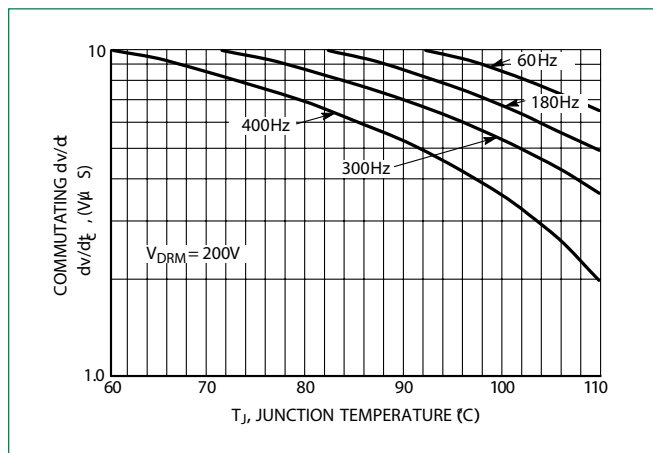

Figure 13. Exponential Static dv/dt versus Gate – Main Terminal 1 Resistance

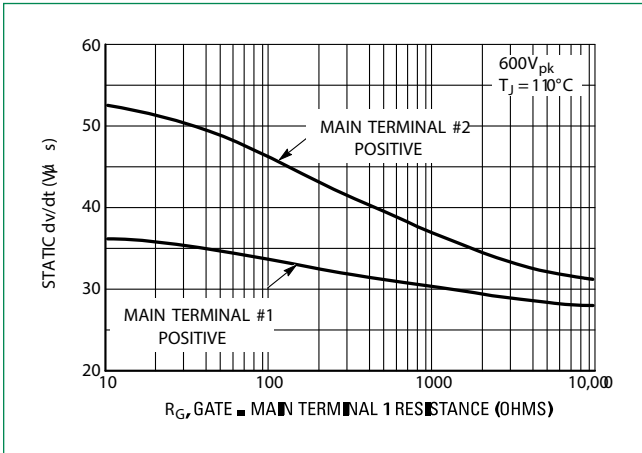

Figure 14. Typical Gate Trigger Current Variation

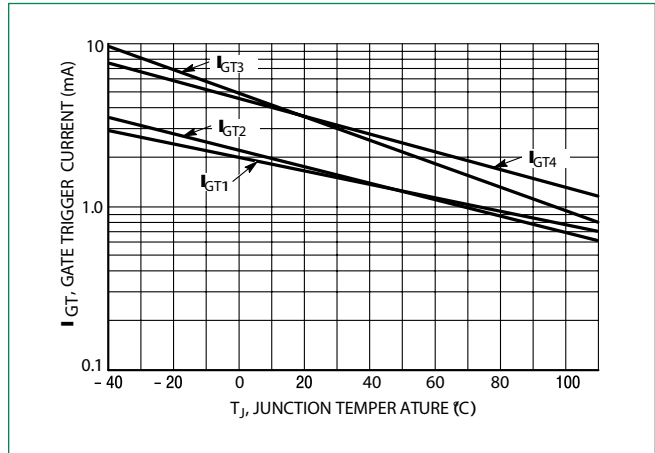

Figure 15. Typical Holding Current Variation

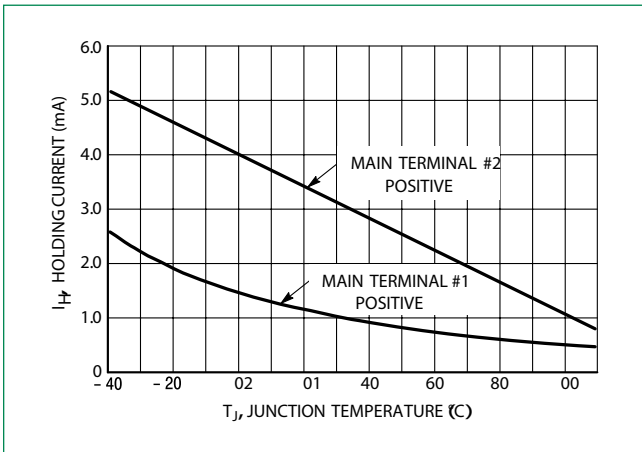
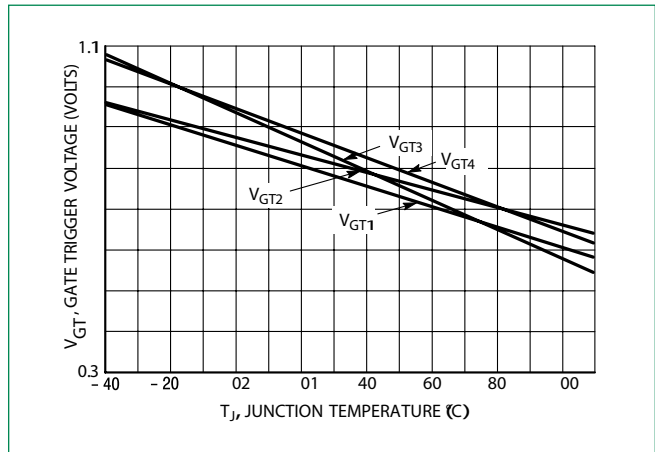
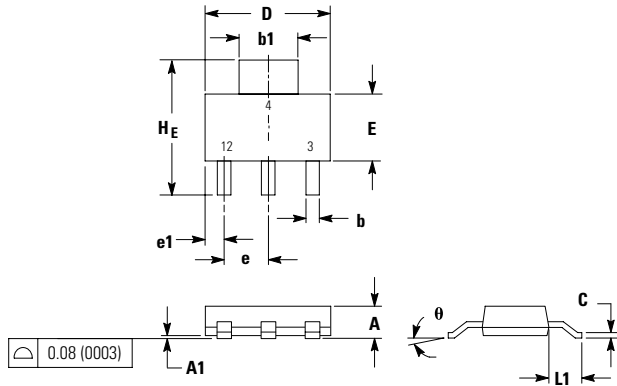

Figure 16. Gate Trigger Voltage Variation



Dimensions



Dim	Inches			Millimeters		
	Min	Nom	Max	Min	Nom	Max
A	---	---	0.071	---	---	1.80
A1	0.001	0.003	0.005	0.02	0.07	0.13
b	0.026	0.030	0.033	0.66	0.75	0.84
b1	0.114	0.118	0.122	2.90	3.00	3.10
c	0.009	0.011	0.014	0.23	0.29	0.35
D	0.260	0.260	0.264	6.60	6.60	6.71
E	0.130	0.138	0.146	3.30	3.50	3.70
e	---	0.091	---	---	2.30	---
e1	0.030	0.037	0.045	0.75	0.95	1.15
L1	0.059	0.069	0.079	1.50	1.75	2.00
HE	0.268	0.276	0.283	6.80	7.00	7.20
θ	0°	---	10°	0°	---	10°

1. DIMENSIONING AND TOLERANCING PER ANSI Y14.5M, 1982.
2. CONTROLLING DIMENSION: INCH.

Pin Assignment	
1	Main Terminal 1
2	Main Terminal 2
3	Gate
4	Main Terminal 2

Part Marking System

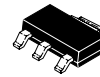

**SOT-223
Case 318E
Style 11**

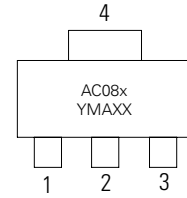

AC08X = Device Code
x = D, M, or N
Y = Year
M = Month
A = Assembly Site
XX = Lot Serial Code
G = Pb-Free Package

Soldering Footprint

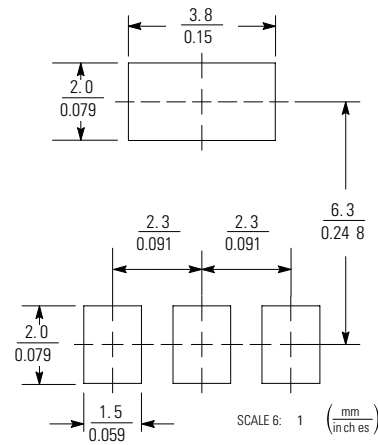

Ordering Information

Device	Package Type	Shipping
MAC08BT1	SOT-223	1000 / Tape & Reel
MAC08BT1G	SOT-223 (Pb-Free)	1000 / Tape & Reel
MAC08MT1	SOT-223	1000 / Tape & Reel
MAC08MT1G	SOT-223 (Pb-Free)	1000 / Tape & Reel

Disclaimer Notice - Information furnished is believed to be accurate and reliable. However, users should independently evaluate the suitability of and test each product selected for their own applications. Littelfuse products are not designed for, and may not be used in, all applications. Read complete Disclaimer Notice at: www.littelfuse.com/disclaimer-electronics

Компания «Life Electronics» занимается поставками электронных компонентов импортного и отечественного производства от производителей и со складов крупных дистрибьюторов Европы, Америки и Азии.

С конца 2013 года компания активно расширяет линейку поставок компонентов по направлению коаксиальный кабель, кварцевые генераторы и конденсаторы (керамические, пленочные, электролитические), за счёт заключения дистрибьюторских договоров

Мы предлагаем:

- Конкурентоспособные цены и скидки постоянным клиентам.
- Специальные условия для постоянных клиентов.
- Подбор аналогов.
- Поставку компонентов в любых объемах, удовлетворяющих вашим потребностям.
- Приемлемые сроки поставки, возможна ускоренная поставка.
- Доставку товара в любую точку России и стран СНГ.
- Комплексную поставку.
- Работу по проектам и поставку образцов.
- Формирование склада под заказчика.
- Сертификаты соответствия на поставляемую продукцию (по желанию клиента).
- Тестирование поставляемой продукции.
- Поставку компонентов, требующих военную и космическую приемку.
- Входной контроль качества.
- Наличие сертификата ISO.

В составе нашей компании организован Конструкторский отдел, призванный помогать разработчикам, и инженерам.

Конструкторский отдел помогает осуществить:

- Регистрацию проекта у производителя компонентов.
- Техническую поддержку проекта.
- Защиту от снятия компонента с производства.
- Оценку стоимости проекта по компонентам.
- Изготовление тестовой платы монтаж и пусконаладочные работы.



Тел: +7 (812) 336 43 04 (многоканальный)

Email: org@lifeelectronics.ru