

SPDT SWITCH GaAs MMIC

■GENERAL DESCRIPTION

NJG1508F is a GaAs SPDT switch MMIC which features low loss, high isolation and low control current, and ideally suitable the cellular phone handsets which needs to switch during two frequency bands.

NJG1508F is operated in the wide frequency range from 50MHz to 3GHz at a low voltage from 2.5V with very small MTP6 package.

■PACKAGE OUTLINE

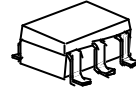

NJG1508F

■FEATURES

- Single and low control voltage
- Low insertion loss
- High isolation
- Transmission power
- Low control current
- Package

+2.5~+5.5V
 0.3dB typ. @f=1.0GHz, $P_{in}=0\text{dBm}$
 27dB typ. @f=1.0GHz, $P_{in}=0\text{dBm}$
 19dBm max. @f=2.0GHz, $V_{CTL}=3.0\text{V}$
 1.0uA typ. @f=0.05~2.5GHz, $P_{in}=10\text{dBm}$
 MTP6 (Mount Size: 2.8x2.9x1.2mm)

■PIN CONFIGURATION

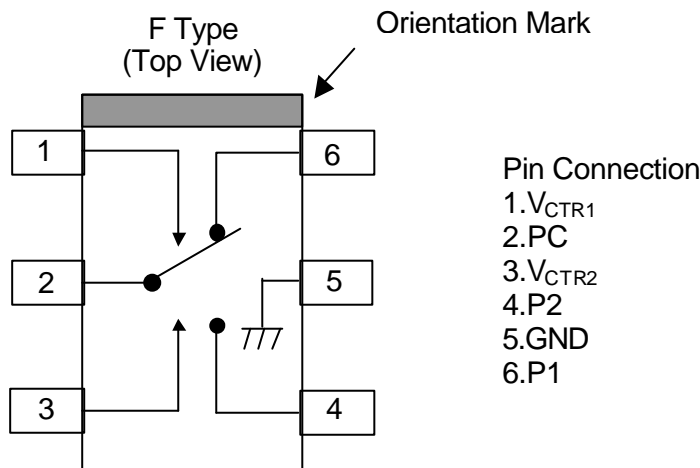

■TRUTH TABLE

“H”= $V_{CTR(H)}$, “L”= $V_{CTR(L)}$

V_{CTR1}	H	L	L	H
V_{CTR2}	L	H	L	H
P1-PC	OFF	ON	Loss=15dB P1 Return Loss=-3dB	Loss=16dB P1 Return Loss=-2dB
P2-PC	ON	OFF	Loss=15dB P2 Return Loss=-3dB	Loss=16dB P2 Return Loss=-2dB

Note) The values of “Loss” and “Return Loss” are typical values.

NJG1508F

■ABSOLUTE MAXIMUM RATINGS

($T_a=25^\circ\text{C}$)

PARAMETER	SYMBOL	RATINGS	UNITS
Input Power	P_{in}	28	dBm
Control Voltage	V_{CTR}	6.0	V
Power Dissipation	P_D	300	mW
Operating Temp.	T_{opr}	-20~+85	$^\circ\text{C}$
Storage Temp.	T_{stg}	-40~+150	$^\circ\text{C}$

■ELECTRICAL CHARACTERISTICS

($V_{CTR(L)}=0\text{V}$, $V_{CTR(H)}=2.7\text{V}$, $Z_S=Z_O=50\Omega$, $T_a=25^\circ\text{C}$)

PARAMETER	SYMBOL	RATINGS	MIN	TYP	MAX	UNITS
Control voltage (L)	$V_{CTR(L)}$	$f=0.05\sim 2.5\text{GHz}$, $P_{in}=10\text{dBm}$	-0.2	0.0	0.2	V
Control voltage (H)	$V_{CTR(H)}$	$f=0.05\sim 2.5\text{GHz}$, $P_{in}=10\text{dBm}$	2.5	2.7	5.5	V
Control current	I_{CTR}	$f=0.05\sim 2.5\text{GHz}$, $P_{in}=10\text{dBm}$	-	1.0	2.0	μA
Insertion loss 1	Loss1	$f=1.0\text{GHz}$, $P_{in}=0\text{dBm}$	-	0.3	0.6	dB
Insertion loss 2	Loss2	$f=2.0\text{GHz}$, $P_{in}=0\text{dBm}$	-	0.5	0.85	dB
Isolation 1 (PC-P1, PC-P2, P1-P2)	ISL1	$f=1.0\text{GHz}$, $P_{in}=0\text{dBm}$	23	27	-	dB
Isolation 2 (PC-P1, PC-P2, P1-P2)	ISL2	$f=2.0\text{GHz}$, $P_{in}=0\text{dBm}$	20	23	-	dB
Pin at 1dB compression point	$P_{-1\text{dB}}$	$f=2.0\text{GHz}$	19	22	-	dBm
VSWR (PC, P1, P2)	VSWR	$f=0.05\sim 2.5\text{GHz}$, ON State	-	1.3	1.6	
Switching time	T_{sw}	$f=0.05\sim 2.5\text{GHz}$	-	15	-	ns

TYPICAL CHARACTERISTICS

(PC-P1) Insertion loss vs. Frequency
 ($V_{CTR}=0V/2.7V$, $P_{in}=0dBm$)

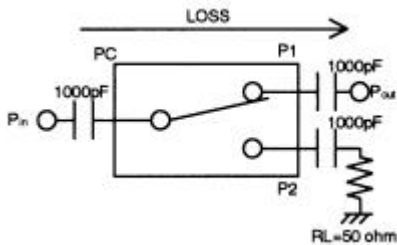
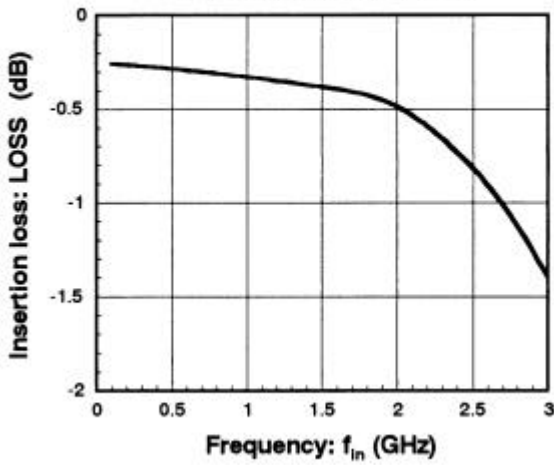

(PC-P2) Insertion loss vs. Frequency
 ($V_{CTR}=0V/2.7V$, $P_{in}=0dBm$)

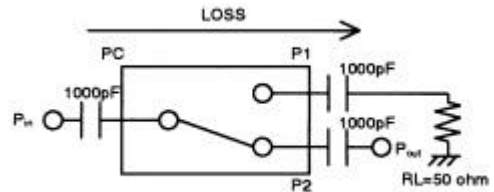
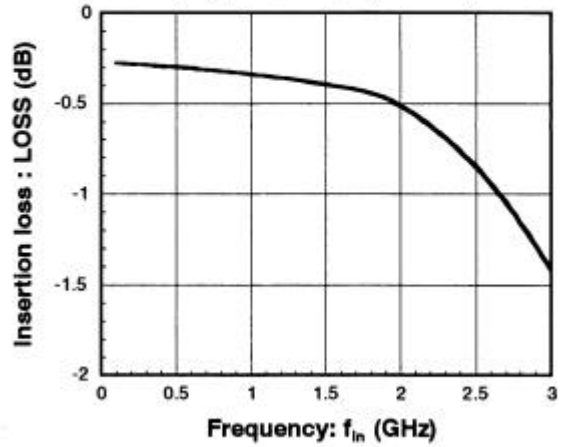

(PC-P1) Isolation vs. Frequency
 ($V_{CTR}=0V/2.7V$, $P_{is}=0dBm$)

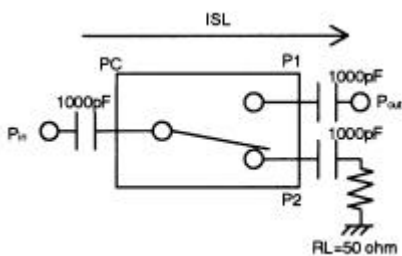
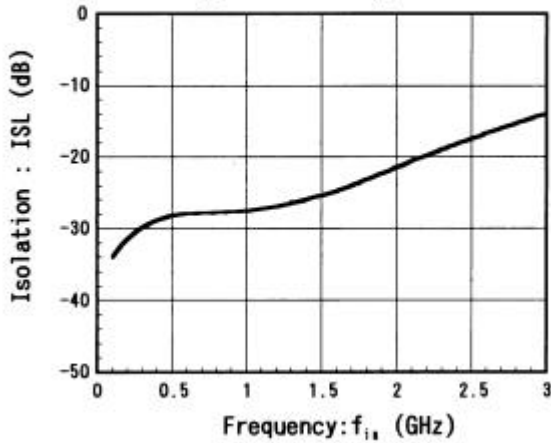

(PC-P2) Isolation vs. Frequency
 ($V_{CTR}=0V/2.7V$, $P_{is}=0dBm$)

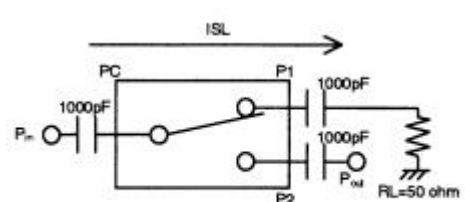
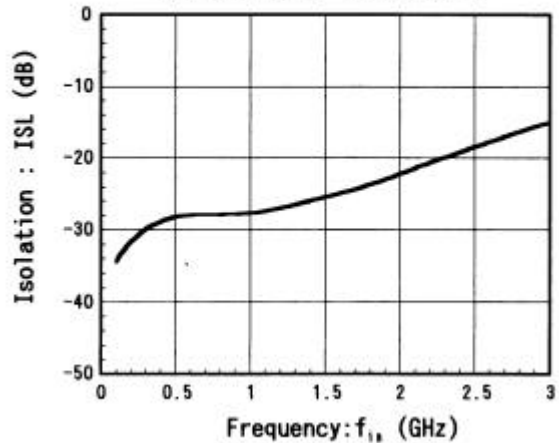

NJG1508F

TYPICAL CHARACTERISTICS

P1-PC(ON) VSWR vs. Frequency
 ($V_{CT1}=0V/2.7V$, $P_{i1}=0dBm$)

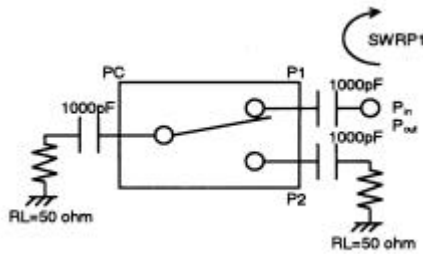
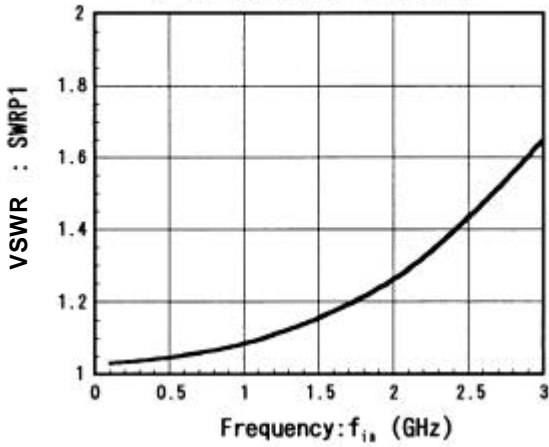

P2-PC(ON) VSWR vs. Frequency
 ($V_{CT1}=0V/2.7V$, $P_{i1}=0dBm$)

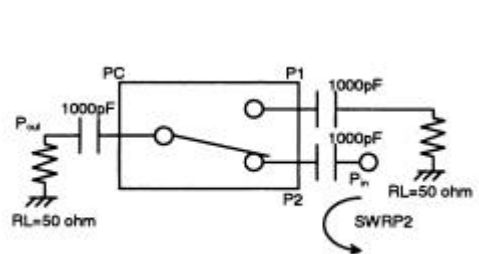
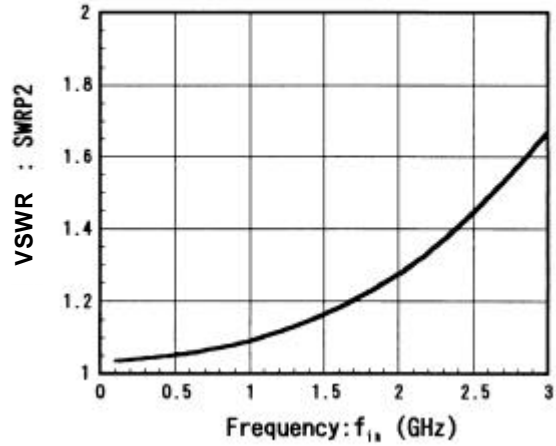

PC-P1(ON) VSWR vs. Frequency
 ($V_{CT1}=0V/2.7V$, $P_{i1}=0dBm$)

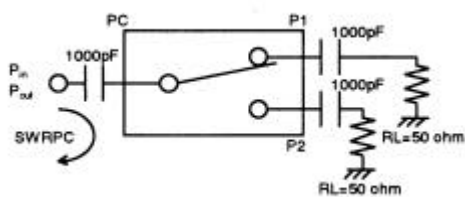
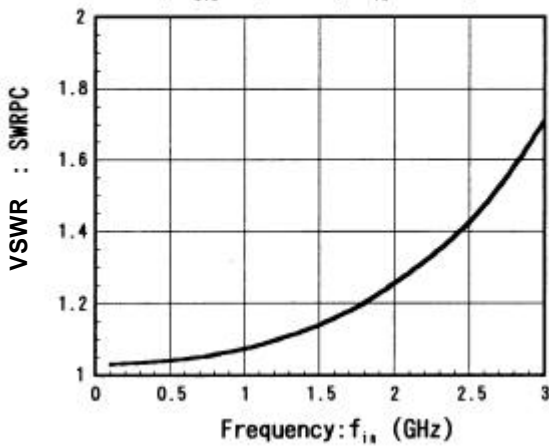

TYPICAL CHARACTERISTICS

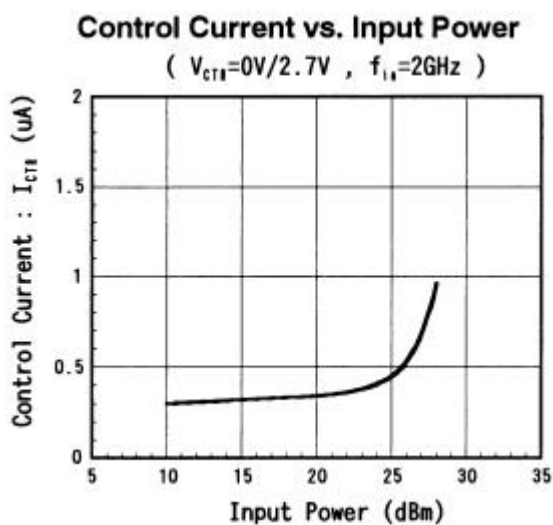
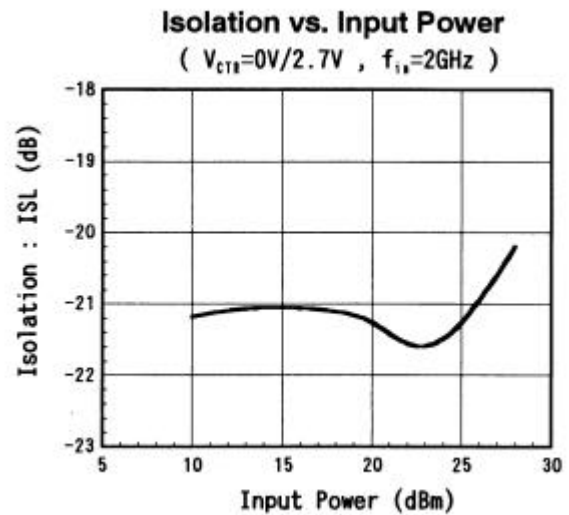
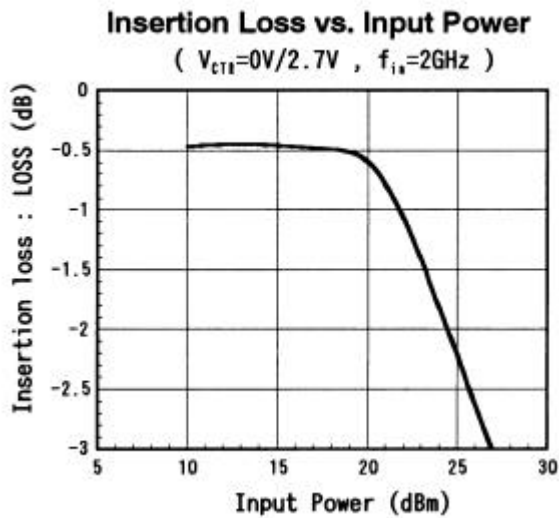
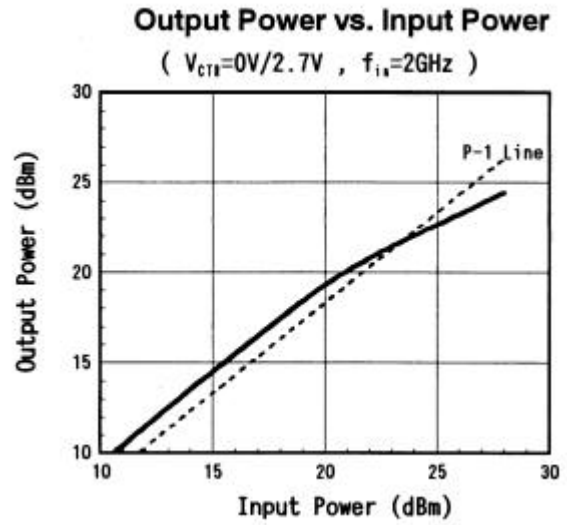
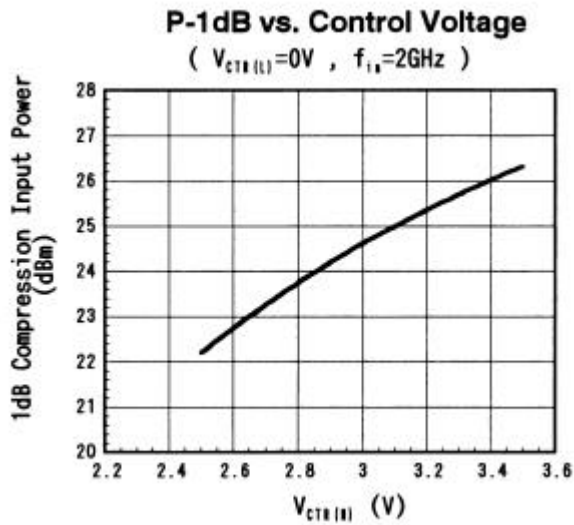

TYPICAL CHARACTERISTICS

Loss/Isolation vs. Temperature
 ($V_{CTK}=0V/2.7V$, $f_{i1}=2GHz$)

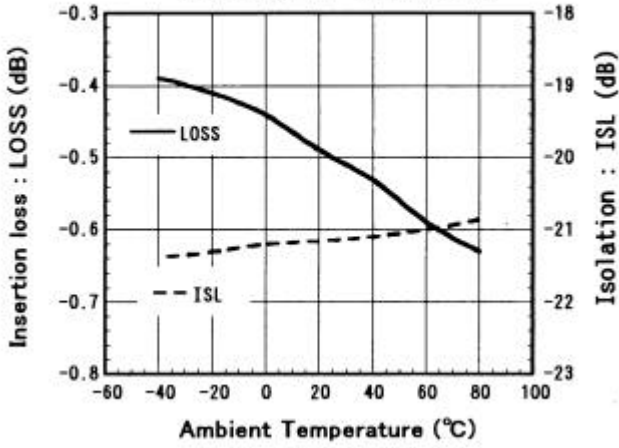

P-1dB vs. Temperature
 ($V_{CTK}=0V/2.7V$, $f_{i1}=2GHz$)

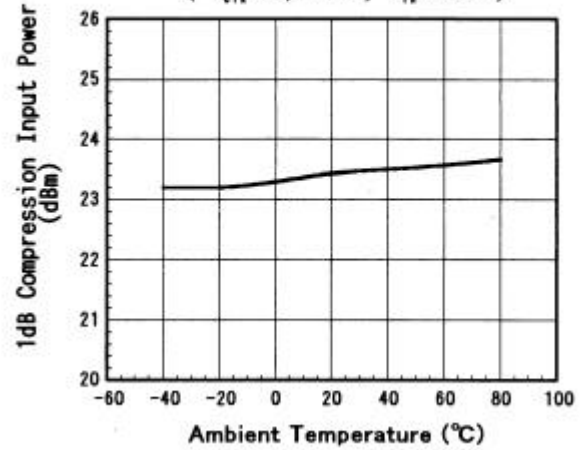

600kHz ACP vs. Temperature

($V_{CTK}=0V/2.7V$, $f_{i1}=1.9GHz$, $P_{i1}=0dBm$)

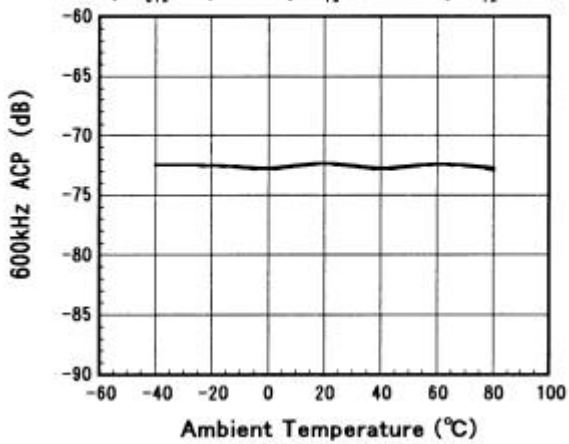

Control Current vs. Temperature

($V_{CTK}=0V/2.7V$, $f_{i1}=2GHz$, $P_{i1}=10dBm$)

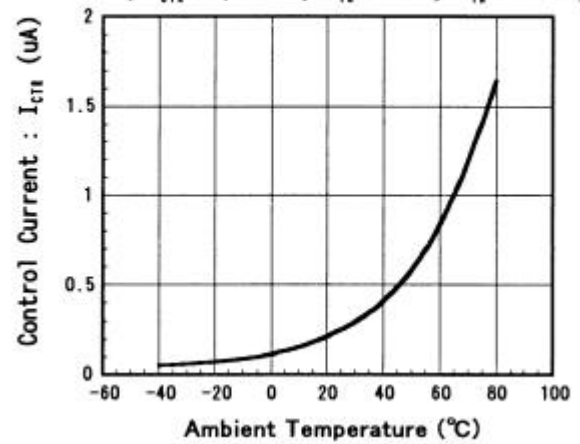

TYPICAL CHARACTERISTICS

P1 PORT IMPEDANCE (OFF STATE)

REF 1.0 Units
 Δ 200.0 mUnits/
 ∇ 221.36 Ω -90.945 $^\circ$

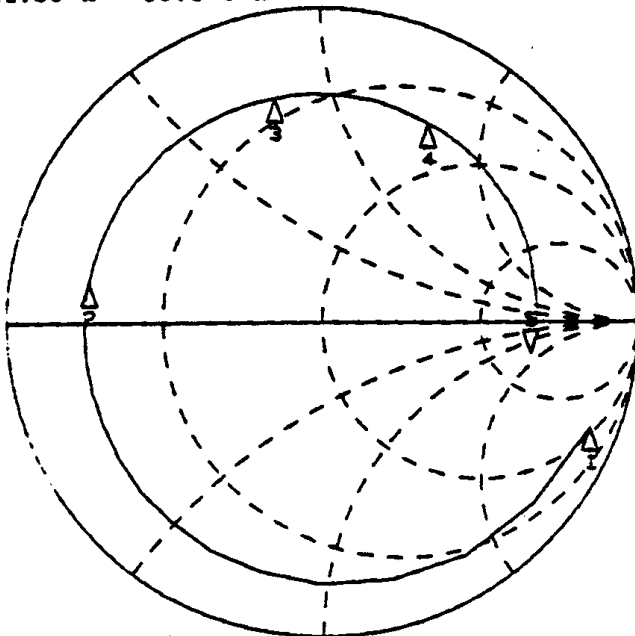

START 0.050000000 GHz
 STOP 3.000000000 GHz

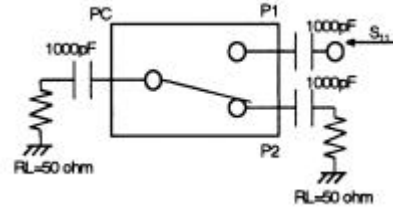

MARKER	f(MHz)	Mag.	Ang. ($^\circ$)
1	50	0.912	-21.7
2	800	0.748	170.1
3	1500	0.728	101.3
4	2000	0.718	61.7
5	3000	0.671	-8.7

P2 PORT IMPEDANCE (OFF STATE)

REF 1.0 Units
 Δ 200.0 mUnits/
 ∇ 228.38 Ω -26.797 $^\circ$

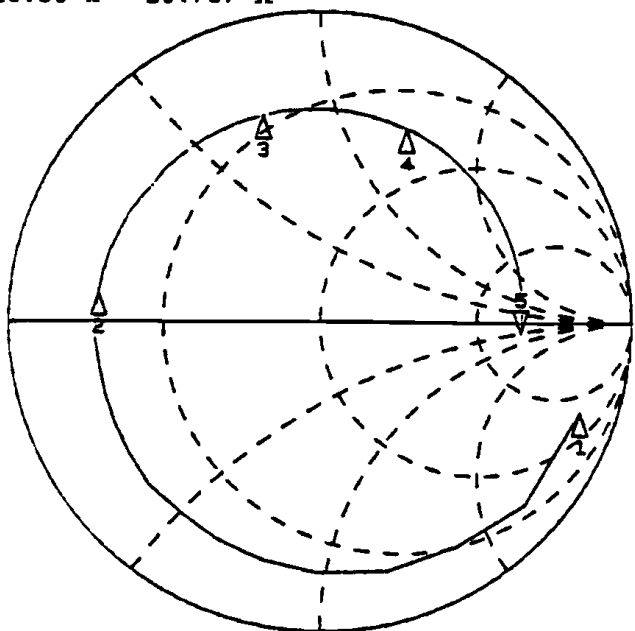

START 0.050000000 GHz
 STOP 3.000000000 GHz

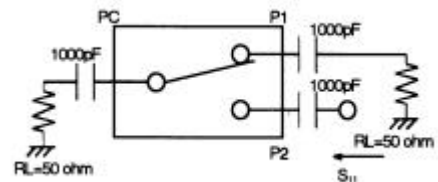

MARKER	f(MHz)	Mag.	Ang. ($^\circ$)
1	50	0.881	-19.2
2	800	0.713	172.3
3	1500	0.690	104.9
4	2000	0.681	66.1
5	3000	0.643	-3.2

■ TYPICAL CHARACTERISTICS

Scattering Parameters: S11 (OFF STATE)

f(MHz)	P1 PORT		P2 PORT	
	Mag.	Ang.(\angle°)	Mag.	Ang.(\angle°)
50	0.912	-21.7	0.881	-19.2
100	0.886	-40.6	0.883	-41.9
200	0.849	-75.2	0.832	-75.1
300	0.818	-103.8	0.787	-103.6
400	0.792	-127.1	0.757	-126.1
500	0.776	-146.5	0.743	-145.5
600	0.762	-163.0	0.726	-161.4
700	0.754	-177.1	0.721	-175.0
800	0.748	170.1	0.713	172.3
900	0.743	158.5	0.709	160.9
1000	0.740	147.7	0.704	150.4
1100	0.728	137.1	0.694	139.9
1200	0.731	128.0	0.696	131.0
1300	0.732	118.7	0.695	122.1
1400	0.730	110.0	0.694	113.3
1500	0.728	101.3	0.690	104.9
1600	0.726	93.0	0.689	96.9
1700	0.724	85.1	0.686	89.1
1800	0.724	77.1	0.684	81.3
1900	0.721	69.1	0.682	73.6
2000	0.718	61.7	0.681	66.1
2100	0.717	54.5	0.679	59.1
2200	0.714	46.9	0.677	51.7
2300	0.710	39.3	0.672	44.4
2400	0.706	32.4	0.670	37.3
2500	0.703	25.1	0.666	30.2
2600	0.696	18.2	0.664	23.4
2700	0.689	11.8	0.658	16.9
2800	0.684	5.0	0.655	10.0
2900	0.679	-2.1	0.648	3.3
3000	0.671	-8.7	0.643	-3.2

■APPLICATION CIRCUIT 1: Single control signal operation by using C-MOS inverter.

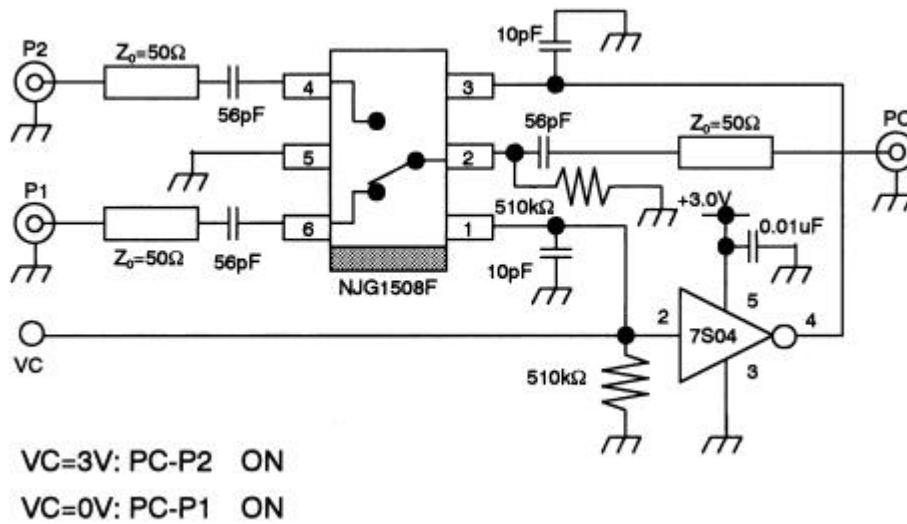

- [1] Please connect bypass capacitors to the supply terminals of the C-MOS inverter.
- [2] In order to stabilize input impedance of inverter, please pull down using 510kΩ resistor from the input terminal of the C-MOS inverter to the ground plane.

■APPLICATION CIRCUIT 2: Single control signal operation by using a transistor.

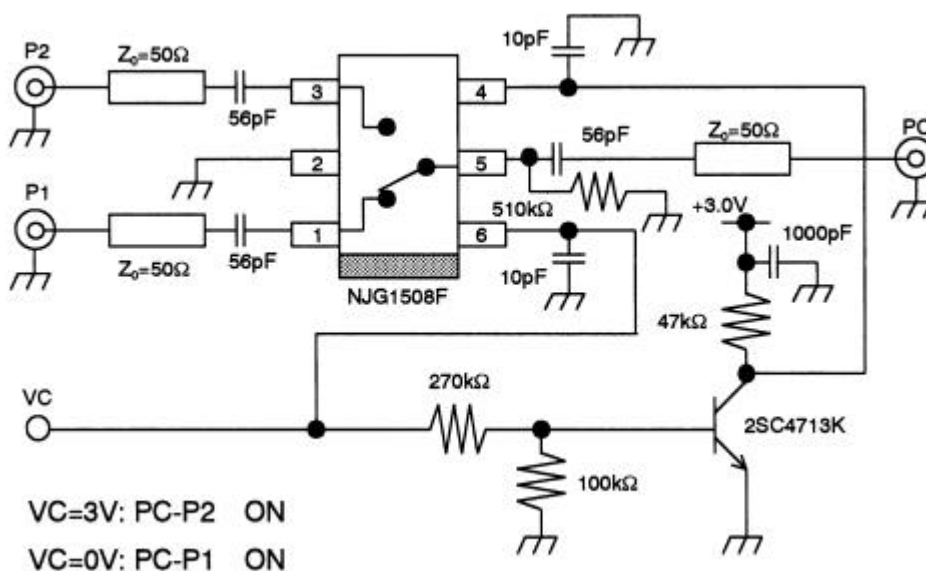

NJG1508F

TEST CIRCUIT

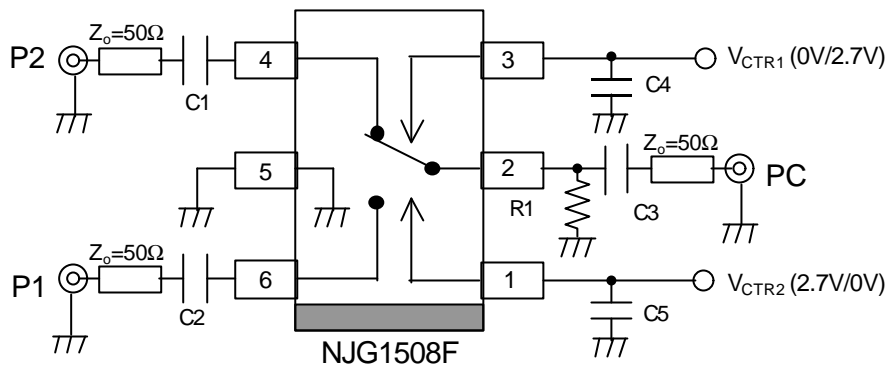

RECOMMENDED PCB DESIGN

(TOP VIEW)

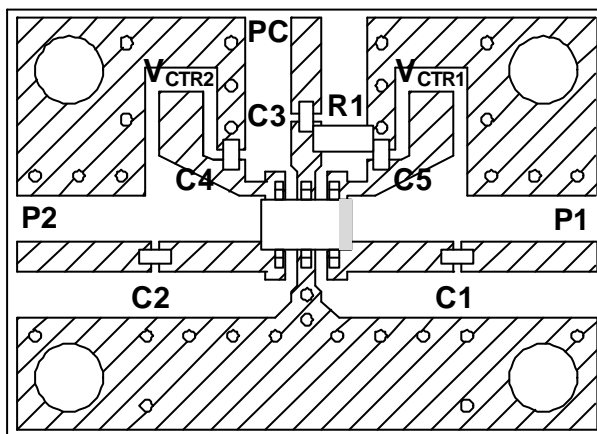

PCB SIZE=19.4x14.0mm
 PCB: FR-4, t=0.5mm
 CAPACITOR: size 1005
 STRIP LINE WIDTH=1mm
 C1~C3: 56pF
 C4, C5: 10pF
 R1: 510kΩ

Precautions

- [1] External capacitors should be connected to the input and output RF terminals (P1, P2, PC) to block the DC current. The above example is a circuit at 900MHz. Please select the capacitor value suitable for actual frequency from 10pF to 1000pF.
- [2] Decoupling capacitors should be connected to the control terminals (V_{CTR1} , V_{CTR2}) as close as possible. The values of these capacitors should be selected from 5pF to 100pF range. Please consider that these values are very effective to switching time (Larger capacitor gives longer switching time).
- [3] In order to keep good isolation characteristics, the ground terminal (5pin) should be connected to the ground pattern with wider width as close as possible, and through-hole in the ground plane should also be placed as close as possible.

PACKAGE OUTLINE (MTP6)

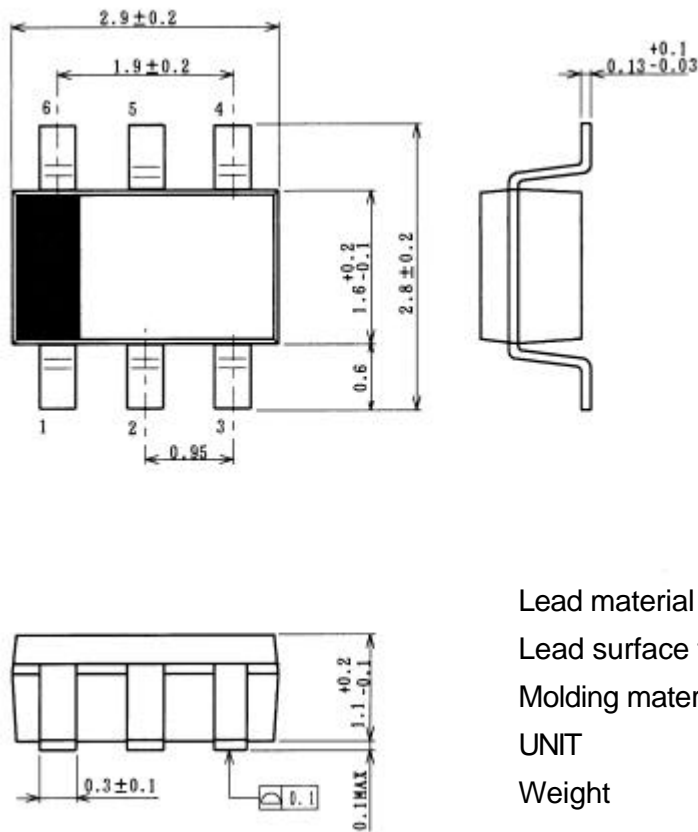

Lead material	: Copper
Lead surface finish	: Solder plating
Molding material	: Epoxy resin
UNIT	: mm
Weight	: 14mg

Cautions on using this product

This product contains Gallium-Arsenide (GaAs) which is a harmful material.

- Do NOT eat or put into mouth.
- Do NOT dispose in fire or break up this product.
- Do NOT chemically make gas or powder with this product.
- To waste this product, please obey the relating law of your country.

[CAUTION]

The specifications on this databook are only given for information, without any guarantee as regards either mistakes or omissions. The application circuits in this databook are described only to show representative usages of the product and not intended for the guarantee or permission of any right including the industrial rights.

This product may be damaged with electric static discharge (ESD) or spike voltage. Please handle with care to avoid these damages.

Компания «Life Electronics» занимается поставками электронных компонентов импортного и отечественного производства от производителей и со складов крупных дистрибьюторов Европы, Америки и Азии.

С конца 2013 года компания активно расширяет линейку поставок компонентов по направлению коаксиальный кабель, кварцевые генераторы и конденсаторы (керамические, пленочные, электролитические), за счёт заключения дистрибьюторских договоров

Мы предлагаем:

- Конкуренспособные цены и скидки постоянным клиентам.
- Специальные условия для постоянных клиентов.
- Подбор аналогов.
- Поставку компонентов в любых объемах, удовлетворяющих вашим потребностям.
- Приемлемые сроки поставки, возможна ускоренная поставка.
- Доставку товара в любую точку России и стран СНГ.
- Комплексную поставку.
- Работу по проектам и поставку образцов.
- Формирование склада под заказчика.
- Сертификаты соответствия на поставляемую продукцию (по желанию клиента).
- Тестирование поставляемой продукции.
- Поставку компонентов, требующих военную и космическую приемку.
- Входной контроль качества.
- Наличие сертификата ISO.

В составе нашей компании организован Конструкторский отдел, призванный помогать разработчикам, и инженерам.

Конструкторский отдел помогает осуществить:

- Регистрацию проекта у производителя компонентов.
- Техническую поддержку проекта.
- Защиту от снятия компонента с производства.
- Оценку стоимости проекта по компонентам.
- Изготовление тестовой платы монтаж и пусконаладочные работы.



Тел: +7 (812) 336 43 04 (многоканальный)
Email: org@lifeelectronics.ru