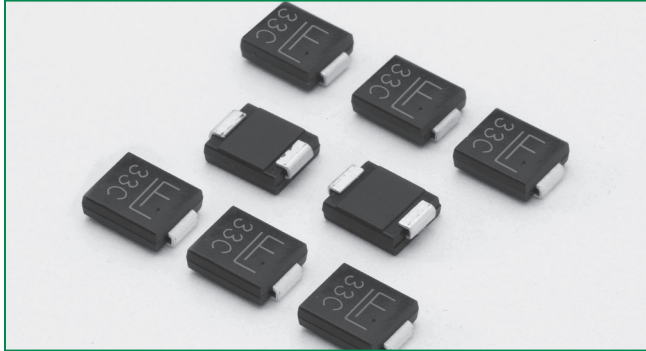


**HF RoHS 1.5SMC Series**



**Agency Approvals**

| AGENCY | AGENCY FILE NUMBER |
|--------|--------------------|
|        | E230531            |

**Maximum Ratings and Thermal Characteristics  
(T<sub>A</sub>=25°C unless otherwise noted)**

| Parameter                                                                                            | Symbol                            | Value      | Unit |
|------------------------------------------------------------------------------------------------------|-----------------------------------|------------|------|
| Peak Pulse Power Dissipation at T <sub>A</sub> =25°C by 10x1000µs waveform (Fig.1)(Note 1), (Note 2) | P <sub>PPM</sub>                  | 1500       | W    |
| Power Dissipation on infinite heat sink at T <sub>A</sub> =50°C                                      | P <sub>MAV</sub>                  | 6.5        | W    |
| Peak Forward Surge Current, 8.3ms Single Half Sine Wave (Note 3)                                     | I <sub>FSM</sub>                  | 200        | A    |
| Maximum Instantaneous Forward Voltage at 100A for Unidirectional only (Note 4)                       | V <sub>F</sub>                    | 3.5/5.0    | V    |
| Operating Junction and Storage Temperature Range                                                     | T <sub>J</sub> , T <sub>STG</sub> | -65 to 150 | °C   |
| Typical Thermal Resistance Junction to Lead                                                          | R <sub>θJL</sub>                  | 15         | °C/W |
| Typical Thermal Resistance Junction to Ambient                                                       | R <sub>θJA</sub>                  | 75         | °C/W |

**Notes:**

1. Non-repetitive current pulse, per Fig. 3 and derated above T<sub>A</sub> = 25°C per Fig. 2.
2. Mounted on copper pad area of 0.31x0.31" (8.0 x 8.0mm) to each terminal.
3. Measured on 8.3ms single half sine wave or equivalent square wave for unidirectional device only, duty cycle=4 per minute maximum.
4. V<sub>F</sub><3.5V for V<sub>BR</sub> ≤ 200V and V<sub>F</sub><5.0V for V<sub>BR</sub> ≥ 201V.

**Description**

The 1.5SMC series is designed specifically to protect sensitive electronic equipment from voltage transients induced by lightning and other transient voltage events.

**Features**


- Halogen-Free
- RoHS compliant
- For surface mounted applications to optimize board space
- Low profile package.
- Built-in strain relief
- Typical maximum temperature coefficient  $\Delta V_{BR} = 0.1\% \times V_{BR}@25^\circ\text{C} \times \Delta T$
- Glass passivated chip junction
- 1500W peak pulse power capability at 10x1000µs waveform, repetition rate (duty cycles):0.01%
- Fast response time: typically less than 1.0ps from 0V to BV min
- Excellent clamping capability
- Low incremental surge resistance
- Typical I<sub>R</sub> less than 1µA above 13V
- High Temperature soldering guaranteed: 260°C/40 seconds at terminals
- Plastic package has Underwriters Laboratory Flammability 94V-0
- Matte Tin Lead-free Plated

**Applications**

TVS devices are ideal for the protection of I/O Interfaces, V<sub>CC</sub> bus and other vulnerable circuits used in Telecom, Computer, Industrial and Consumer electronic applications.

1.5SMC Series

### Electrical Characteristics

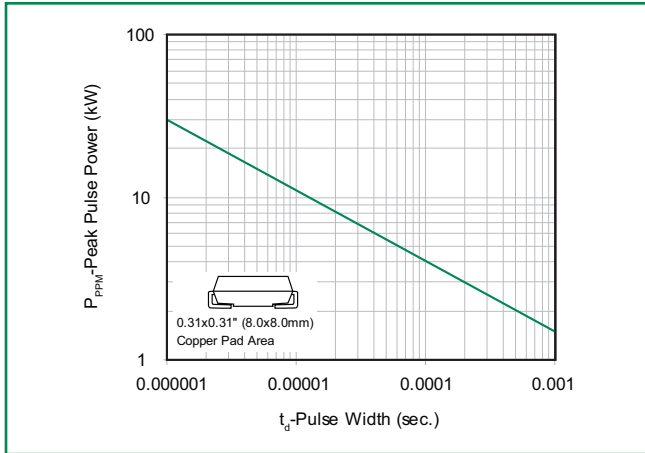
| Part Number (Uni) | Part Number (Bi) | Marking |      | Reverse Stand off Voltage $V_R$ (Volts) | Breakdown Voltage $V_{BR}$ (Volts) @ $I_T$ |        | Test Current $I_T$ (mA) | Maximum Clamping Voltage $V_C$ @ $I_{PP}$ (V) | Maximum Peak Pulse Current $I_{PP}$ (A) | Maximum Reverse Leakage $I_R$ @ $V_R$ ( $\mu$ A) | Agency Approval  |
|-------------------|------------------|---------|------|-----------------------------------------|--------------------------------------------|--------|-------------------------|-----------------------------------------------|-----------------------------------------|--------------------------------------------------|-----------------------------------------------------------------------------------------------------|
|                   |                  | UNI     | BI   |                                         | MIN                                        | MAX    |                         |                                               |                                         |                                                  |                                                                                                     |
| 1.5SMC6.8A        | 1.5SMC6.8CA      | 6V8A    | 6V8C | 5.80                                    | 6.45                                       | 7.14   | 10                      | 10.5                                          | 144.8                                   | 1000                                             | X                                                                                                   |
| 1.5SMC7.5A        | 1.5SMC7.5CA      | 7V5A    | 7V5C | 6.40                                    | 7.13                                       | 7.88   | 10                      | 11.3                                          | 134.5                                   | 500                                              | X                                                                                                   |
| 1.5SMC8.2A        | 1.5SMC8.2CA      | 8V2A    | 8V2C | 7.02                                    | 7.79                                       | 8.61   | 10                      | 12.1                                          | 125.6                                   | 200                                              | X                                                                                                   |
| 1.5SMC9.1A        | 1.5SMC9.1CA      | 9V1A    | 9V1C | 7.78                                    | 8.65                                       | 9.50   | 1                       | 13.4                                          | 113.4                                   | 50                                               | X                                                                                                   |
| 1.5SMC10A         | 1.5SMC10CA       | 10A     | 10C  | 8.55                                    | 9.50                                       | 10.50  | 1                       | 14.5                                          | 104.8                                   | 10                                               | X                                                                                                   |
| 1.5SMC11A         | 1.5SMC11CA       | 11A     | 11C  | 9.40                                    | 10.50                                      | 11.60  | 1                       | 15.6                                          | 97.4                                    | 5                                                | X                                                                                                   |
| 1.5SMC12A         | 1.5SMC12CA       | 12A     | 12C  | 10.20                                   | 11.40                                      | 12.60  | 1                       | 16.7                                          | 91.0                                    | 5                                                | X                                                                                                   |
| 1.5SMC13A         | 1.5SMC13CA       | 13A     | 13C  | 11.10                                   | 12.40                                      | 13.70  | 1                       | 18.2                                          | 83.5                                    | 1                                                | X                                                                                                   |
| 1.5SMC15A         | 1.5SMC15CA       | 15A     | 15C  | 12.80                                   | 14.30                                      | 15.80  | 1                       | 21.2                                          | 71.7                                    | 1                                                | X                                                                                                   |
| 1.5SMC16A         | 1.5SMC16CA       | 16A     | 16C  | 13.60                                   | 15.20                                      | 16.80  | 1                       | 22.5                                          | 67.6                                    | 1                                                | X                                                                                                   |
| 1.5SMC18A         | 1.5SMC18CA       | 18A     | 18C  | 15.30                                   | 17.10                                      | 18.90  | 1                       | 25.2                                          | 60.3                                    | 1                                                | X                                                                                                   |
| 1.5SMC20A         | 1.5SMC20CA       | 20A     | 20C  | 17.10                                   | 19.00                                      | 21.00  | 1                       | 27.7                                          | 54.9                                    | 1                                                | X                                                                                                   |
| 1.5SMC22A         | 1.5SMC22CA       | 22A     | 22C  | 18.80                                   | 20.90                                      | 23.10  | 1                       | 30.6                                          | 49.7                                    | 1                                                | X                                                                                                   |
| 1.5SMC24A         | 1.5SMC24CA       | 24A     | 24C  | 20.50                                   | 22.80                                      | 25.20  | 1                       | 33.2                                          | 45.8                                    | 1                                                | X                                                                                                   |
| 1.5SMC27A         | 1.5SMC27CA       | 27A     | 27C  | 23.10                                   | 25.70                                      | 28.40  | 1                       | 37.5                                          | 40.5                                    | 1                                                | X                                                                                                   |
| 1.5SMC30A         | 1.5SMC30CA       | 30A     | 30C  | 25.60                                   | 28.50                                      | 31.50  | 1                       | 41.4                                          | 36.7                                    | 1                                                | X                                                                                                   |
| 1.5SMC33A         | 1.5SMC33CA       | 33A     | 33C  | 28.20                                   | 31.40                                      | 34.70  | 1                       | 45.7                                          | 33.3                                    | 1                                                | X                                                                                                   |
| 1.5SMC36A         | 1.5SMC36CA       | 36A     | 36C  | 30.80                                   | 34.20                                      | 37.80  | 1                       | 49.9                                          | 30.5                                    | 1                                                | X                                                                                                   |
| 1.5SMC39A         | 1.5SMC39CA       | 39A     | 39C  | 33.30                                   | 37.10                                      | 41.00  | 1                       | 53.9                                          | 28.2                                    | 1                                                | X                                                                                                   |
| 1.5SMC43A         | 1.5SMC43CA       | 43A     | 43C  | 36.80                                   | 40.90                                      | 45.20  | 1                       | 59.3                                          | 25.6                                    | 1                                                | X                                                                                                   |
| 1.5SMC47A         | 1.5SMC47CA       | 47A     | 47C  | 40.20                                   | 44.70                                      | 49.40  | 1                       | 64.8                                          | 23.5                                    | 1                                                | X                                                                                                   |
| 1.5SMC51A         | 1.5SMC51CA       | 51A     | 51C  | 43.60                                   | 48.50                                      | 53.60  | 1                       | 70.1                                          | 21.7                                    | 1                                                | X                                                                                                   |
| 1.5SMC56A         | 1.5SMC56CA       | 56A     | 56C  | 47.80                                   | 53.20                                      | 58.80  | 1                       | 77.0                                          | 19.7                                    | 1                                                | X                                                                                                   |
| 1.5SMC62A         | 1.5SMC62CA       | 62A     | 62C  | 53.00                                   | 58.90                                      | 65.10  | 1                       | 85.0                                          | 17.9                                    | 1                                                | X                                                                                                   |
| 1.5SMC68A         | 1.5SMC68CA       | 68A     | 68C  | 58.10                                   | 64.60                                      | 71.40  | 1                       | 92.0                                          | 16.5                                    | 1                                                | X                                                                                                   |
| 1.5SMC75A         | 1.5SMC75CA       | 75A     | 75C  | 64.10                                   | 71.30                                      | 78.80  | 1                       | 103.0                                         | 14.8                                    | 1                                                | X                                                                                                   |
| 1.5SMC82A         | 1.5SMC82CA       | 82A     | 82C  | 70.10                                   | 77.90                                      | 86.10  | 1                       | 113.0                                         | 13.5                                    | 1                                                | X                                                                                                   |
| 1.5SMC91A         | 1.5SMC91CA       | 91A     | 91C  | 77.80                                   | 86.50                                      | 95.50  | 1                       | 125.0                                         | 12.2                                    | 1                                                | X                                                                                                   |
| 1.5SMC100A        | 1.5SMC100CA      | 68A     | 100C | 85.50                                   | 95.00                                      | 105.00 | 1                       | 137.0                                         | 11.1                                    | 1                                                | X                                                                                                   |
| 1.5SMC110A        | 1.5SMC110CA      | 75A     | 110C | 94.00                                   | 105.00                                     | 116.00 | 1                       | 152.0                                         | 10.0                                    | 1                                                | X                                                                                                   |
| 1.5SMC120A        | 1.5SMC120CA      | 120A    | 120C | 102.00                                  | 114.00                                     | 126.00 | 1                       | 165.0                                         | 9.2                                     | 1                                                | X                                                                                                   |
| 1.5SMC130A        | 1.5SMC130CA      | 130A    | 130C | 111.00                                  | 124.00                                     | 137.00 | 1                       | 179.0                                         | 8.5                                     | 1                                                | X                                                                                                   |
| 1.5SMC150A        | 1.5SMC150CA      | 150A    | 150C | 128.00                                  | 143.00                                     | 158.00 | 1                       | 207.0                                         | 7.3                                     | 1                                                | X                                                                                                   |
| 1.5SMC160A        | 1.5SMC160CA      | 160A    | 160C | 136.00                                  | 152.00                                     | 168.00 | 1                       | 219.0                                         | 6.9                                     | 1                                                | X                                                                                                   |
| 1.5SMC170A        | 1.5SMC170CA      | 170A    | 170C | 145.00                                  | 162.00                                     | 179.00 | 1                       | 234.0                                         | 6.5                                     | 1                                                | X                                                                                                   |
| 1.5SMC180A        | 1.5SMC180CA      | 180A    | 180C | 154.00                                  | 171.00                                     | 189.00 | 1                       | 246.0                                         | 6.2                                     | 1                                                | X                                                                                                   |
| 1.5SMC200A        | 1.5SMC200CA      | 200A    | 200C | 171.00                                  | 190.00                                     | 210.00 | 1                       | 274.0                                         | 5.5                                     | 1                                                | X                                                                                                   |
| 1.5SMC220A        | 1.5SMC220CA      | 220A    | 220C | 185.00                                  | 209.00                                     | 231.00 | 1                       | 328.0                                         | 4.6                                     | 1                                                | X                                                                                                   |
| 1.5SMC250A        | 1.5SMC250CA      | 250A    | 250C | 214.00                                  | 237.00                                     | 263.00 | 1                       | 344.0                                         | 4.4                                     | 1                                                | X                                                                                                   |
| 1.5SMC300A        | 1.5SMC300CA      | 300A    | 300C | 256.00                                  | 285.00                                     | 315.00 | 1                       | 414.0                                         | 3.7                                     | 1                                                | X                                                                                                   |
| 1.5SMC350A        | 1.5SMC350CA      | 350A    | 350C | 300.00                                  | 332.00                                     | 368.00 | 1                       | 482.0                                         | 3.2                                     | 1                                                | X                                                                                                   |
| 1.5SMC400A        | 1.5SMC400CA      | 400A    | 400C | 342.00                                  | 380.00                                     | 420.00 | 1                       | 548.0                                         | 2.8                                     | 1                                                | X                                                                                                   |
| 1.5SMC440A        | 1.5SMC440CA      | 440A    | 440C | 376.00                                  | 418.00                                     | 462.00 | 1                       | 602.0                                         | 2.5                                     | 1                                                | X                                                                                                   |
| 1.5SMC480A        | 1.5SMC480CA      | 480A    | 480C | 408.00                                  | 456.00                                     | 504.00 | 1                       | 658.0                                         | 2.3                                     | 1                                                | X                                                                                                   |
| 1.5SMC510A        | 1.5SMC510CA      | 510A    | 510C | 434.00                                  | 485.00                                     | 535.00 | 1                       | 698.0                                         | 2.1                                     | 1                                                | X                                                                                                   |
| 1.5SMC530A        | 1.5SMC530CA      | 530A    | 530C | 477.00                                  | 503.50                                     | 556.50 | 1                       | 725.0                                         | 2.1                                     | 1                                                | X                                                                                                   |
| 1.5SMC540A        | 1.5SMC540CA      | 540A    | 540C | 486.00                                  | 513.00                                     | 567.00 | 1                       | 740.0                                         | 2.0                                     | 1                                                | X                                                                                                   |
| 1.5SMC550A        | 1.5SMC550CA      | 550A    | 550C | 495.00                                  | 522.50                                     | 577.50 | 1                       | 760.0                                         | 2.0                                     | 1                                                | X                                                                                                   |

For bidirectional type having  $V_R$  of 10 volts and less, the  $I_R$  limit is double.

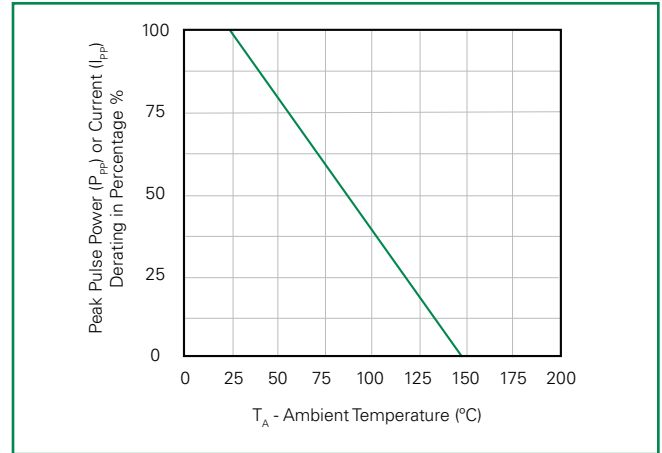
For parts without A, the  $V_{BR}$  is  $\pm 10\%$

### Ratings and Characteristic Curves ( $T_A=25^\circ\text{C}$ unless otherwise noted)

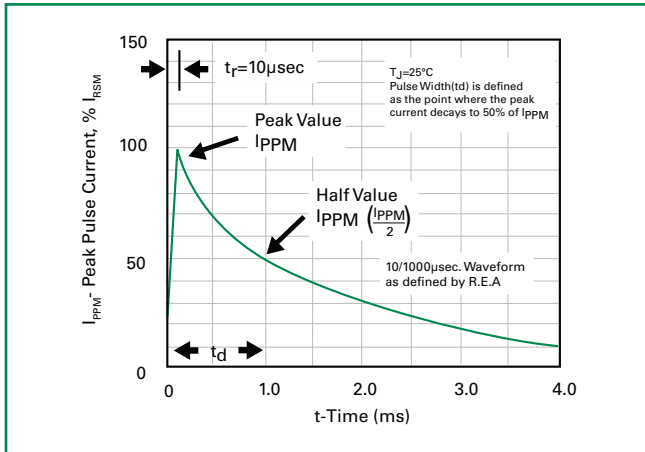
**Figure 1 - Peak Pulse Power Rating**



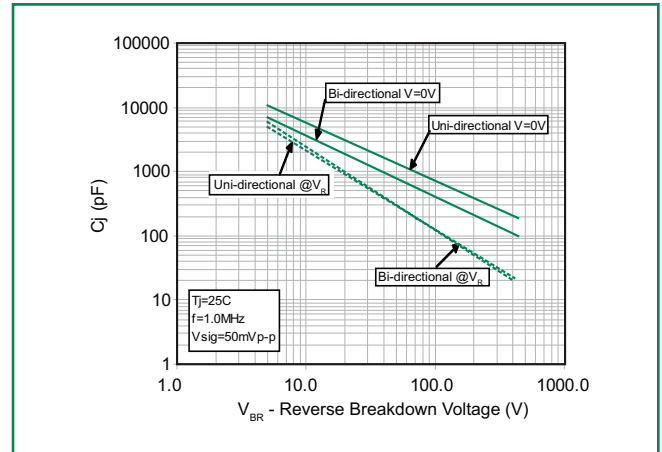
**Figure 2 - Pulse Derating Curve**



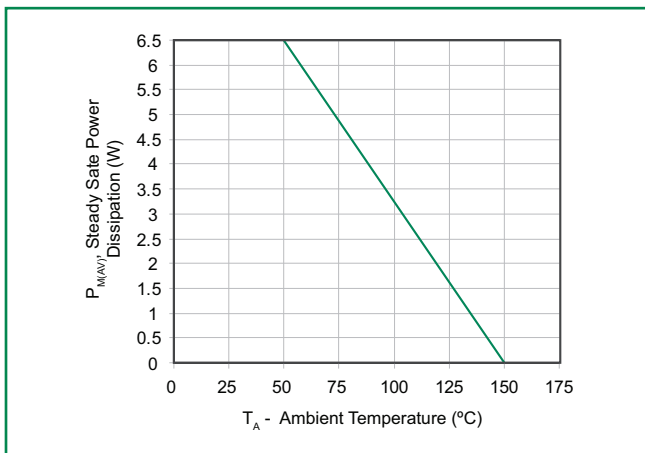
**Figure 3 - Pulse Waveform**



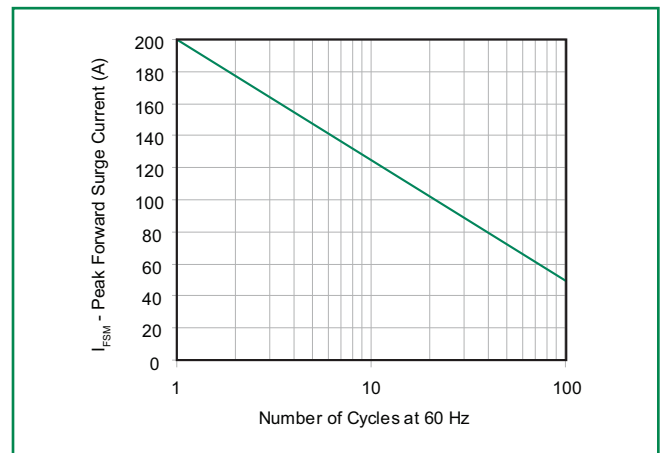
**Figure 4 - Typical Junction Capacitance**



**Figure 5 - Steady State Power Dissipation Derating Curve**

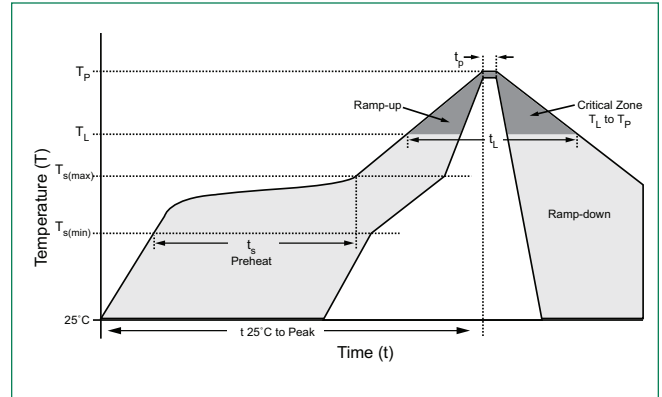


**Figure 6 - Maximum Non-Repetitive Peak Forward Surge Current Uni-Directional Only**



### Soldering Parameters

|                                                        |                                    |                         |
|--------------------------------------------------------|------------------------------------|-------------------------|
| Reflow Condition                                       |                                    | Lead-free assembly      |
| Pre Heat                                               | - Temperature Min ( $T_{s(min)}$ ) | 150°C                   |
|                                                        | - Temperature Max ( $T_{s(max)}$ ) | 200°C                   |
|                                                        | - Time (min to max) ( $t_s$ )      | 60 – 180 secs           |
| Average ramp up rate (Liquidus Temp ( $T_L$ ) to peak) |                                    | 3°C/second max          |
| $T_{s(max)}$ to $T_L$ - Ramp-up Rate                   |                                    | 3°C/second max          |
| Reflow                                                 | - Temperature ( $T_L$ ) (Liquidus) | 217°C                   |
|                                                        | - Time (min to max) ( $t_s$ )      | 60 – 150 seconds        |
| Peak Temperature ( $T_p$ )                             |                                    | 260 <sup>+0/-5</sup> °C |
| Time within 5°C of actual peak Temperature ( $t_p$ )   |                                    | 20 – 40 seconds         |
| Ramp-down Rate                                         |                                    | 6°C/second max          |
| Time 25°C to peak Temperature ( $T_p$ )                |                                    | 8 minutes Max.          |
| Do not exceed                                          |                                    | 280°C                   |



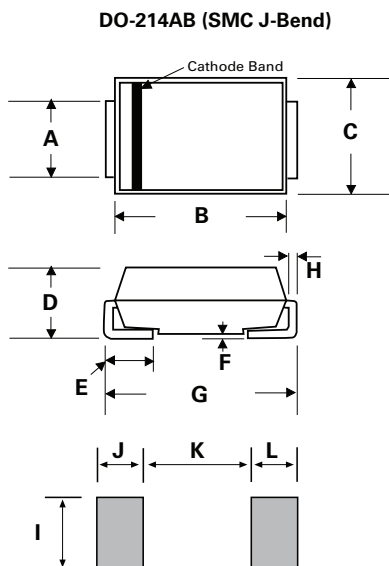
### Physical Specifications

|                 |                                                                   |
|-----------------|-------------------------------------------------------------------|
| <b>Weight</b>   | 0.007 ounce, 0.21 grams                                           |
| <b>Case</b>     | JEDEC DO214AB. Molded plastic body over glass passivated junction |
| <b>Polarity</b> | Color band denotes positive end (cathode) except Bidirectional.   |
| <b>Terminal</b> | Matte Tin-plated leads, Solderable per JESD22-B102D               |

### Environmental Specifications

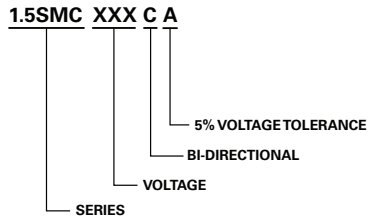
|                           |              |
|---------------------------|--------------|
| <b>Temperature Cycle</b>  | JESD22-A104  |
| <b>Pressure Cooker</b>    | JESD 22-A102 |
| <b>High Temp. Storage</b> | JESD22-A103  |
| <b>HTRB</b>               | JESD22-A108  |
| <b>Thermal Shock</b>      | JESD22-A106  |

### Dimensions

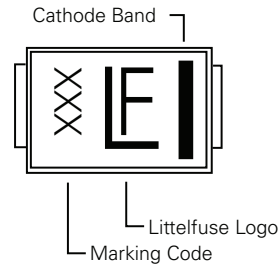


| Dimensions | Inches |       | Millimeters |       |
|------------|--------|-------|-------------|-------|
|            | Min    | Max   | Min         | Max   |
| A          | 0.114  | 0.126 | 2.900       | 3.200 |
| B          | 0.260  | 0.280 | 6.600       | 7.110 |
| C          | 0.220  | 0.245 | 5.590       | 6.220 |
| D          | 0.079  | 0.103 | 2.060       | 2.620 |
| E          | 0.030  | 0.060 | 0.760       | 1.520 |
| F          | -      | 0.008 | -           | 0.203 |
| G          | 0.305  | 0.320 | 7.750       | 8.130 |
| H          | 0.006  | 0.012 | 0.152       | 0.305 |
| I          | 0.129  | -     | 3.300       | -     |
| J          | 0.094  | -     | 2.400       | -     |
| K          | -      | 0.165 | -           | 4.200 |
| L          | 0.094  | -     | 2.400       | -     |

### Part Numbering System



### Part Marking System



### Packaging

| Part number | Component Package | Quantity | Packaging Option            | Packaging Specification |
|-------------|-------------------|----------|-----------------------------|-------------------------|
| 1.5SMCxxxXX | DO-214AB          | 3000     | Tape & Reel – 16mm/13" tape | EIA STD RS-481          |

Компания «Life Electronics» занимается поставками электронных компонентов импортного и отечественного производства от производителей и со складов крупных дистрибьюторов Европы, Америки и Азии.

С конца 2013 года компания активно расширяет линейку поставок компонентов по направлению коаксиальный кабель, кварцевые генераторы и конденсаторы (керамические, пленочные, электролитические), за счёт заключения дистрибьюторских договоров

Мы предлагаем:

- Конкуренспособные цены и скидки постоянным клиентам.
- Специальные условия для постоянных клиентов.
- Подбор аналогов.
- Поставку компонентов в любых объемах, удовлетворяющих вашим потребностям.
- Приемлемые сроки поставки, возможна ускоренная поставка.
- Доставку товара в любую точку России и стран СНГ.
- Комплексную поставку.
- Работу по проектам и поставку образцов.
- Формирование склада под заказчика.
- Сертификаты соответствия на поставляемую продукцию (по желанию клиента).
- Тестирование поставляемой продукции.
- Поставку компонентов, требующих военную и космическую приемку.
- Входной контроль качества.
- Наличие сертификата ISO.

В составе нашей компании организован Конструкторский отдел, призванный помогать разработчикам, и инженерам.

Конструкторский отдел помогает осуществить:

- Регистрацию проекта у производителя компонентов.
- Техническую поддержку проекта.
- Защиту от снятия компонента с производства.
- Оценку стоимости проекта по компонентам.
- Изготовление тестовой платы монтаж и пусконаладочные работы.



Тел: +7 (812) 336 43 04 (многоканальный)

Email: [org@lifeelectronics.ru](mailto:org@lifeelectronics.ru)