

EKMC(VZ) series

Current consumption **170 μ A** **Digital output**

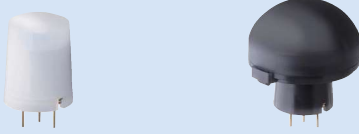

Standard detection type



Long distance detection type



Wall installation type

○Economy type suitable for a wide range of applications

Recommended applications

Lighting control, lighting equipment, heaters, ventilators or air conditioners, security equipment for IP cameras, intrusion alarms, digital signage, vending machines, multi-function printers, display panels for meeting rooms, PCs

Lensless type available
170 μ A type: EKMC1600100

Specifications

Detection performance	Model no.	Current consumption	Lens color	Output type	Detection distance	Detection area		Detection zones
						Horizontal	Vertical	
Standard detection type 	EKMC1601111	170 μ A	White	Digital	5m	94°	82°	64
	EKMC1601112		Black					
	EKMC1601113		Pearl white					
Long distance detection type 	EKMC1603111		White		12m	102°	92°	92
	EKMC1603112		Black					
	EKMC1603113		Pearl white					
Wall installation type 	EKMC1604111		White		12m (1st step lens) 6m (2nd step lens) 3m (3rd step lens)	40°	105°	68
	EKMC1604112		Black					
	EKMC1604113		Pearl white					

■ Ordering information

EKMC16 **1**

- PaPIRs motion sensor
- Detection (Lens)
 - 00: Lensless / 01: 5m distance standard / 03: 12m long distance / 04: Wall installation type

- Lens color
 - 0: Lensless / 1: White / 2: Black / 3: Pearl white
- Lens
 - 0: Lensless / 1: with lens

Characteristics

■ Maximum rated values

Items	Value
Power supply voltage	-0.3 to 7V
Ambient temperature	-20 to +60°C (no frost, no condensation)
Storage temperature	-20 to +70°C

■ Electrical characteristics

Items		Symbol	EKMC (VZ) type	Conditions
Operating voltage	Max	Vdd	6.0V	—
	Min		3.0V	
Current consumption (in standby mode) Note 1)	Ave	Iw	170 μ A	Ambient temperature: 25°C Iout=0 Vdd: 5V
Output current (during detection) Note 2)	Max	Iout	100 μ A	Ambient temperature: 25°C Vout \geq Vdd-0.5
Output voltage (during detection period)	Min	Vout	Vdd-0.5V	Ambient temperature: 25°C Open at no detection
Circuit stability time (when voltage is applied)	Max	Twu	30 sec	Ambient temperature: 25°C Iout=0 Vdd: 5V

Note 1) Current consumption during detection period is the total value of current consumption in standby mode add to output current.
Note 2) Please select an output resistors (pull-down concept) in accordance with Vout so that the output current is lower than or equal to 100 μ A. If the output current is more than 100 μ A, this may cause false alarms.

Timing chart



[Explanation of the timing]
Twu: Circuit stability time: max. 30 sec
During this stage, the output's status is undefined (ON/OFF) and detection is therefore not guaranteed.

Lenses for the EKMB/EKMC series

Dimension (mm)

Detection zone

Detection characteristics

Standard detection type

CAD data

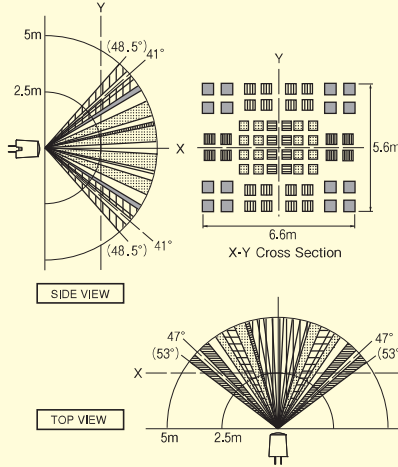
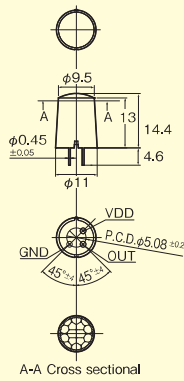

Detection distance	Max. 5m
Field of view	94°×82°
Detection zone	64 beams
Detection condition	<ul style="list-style-type: none"> The temperature difference between the target and the surroundings must be higher than 4°C. Movement speed: 1.0m/s Target concept: Human body with an approx. size of 700×250mm Target moving direction: Crossing the detection beam.

Long distance detection type

CAD data

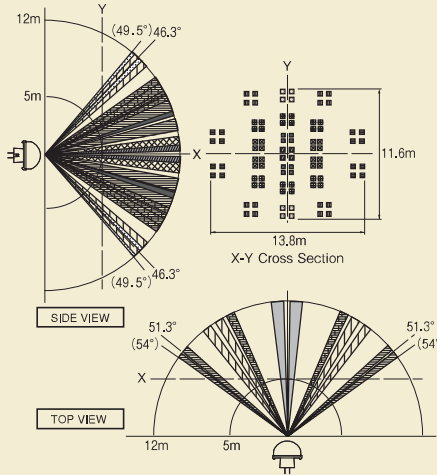

Detection distance	Max. 12m
Field of view	102°×92°
Detection zone	92 beams
Detection condition	<ul style="list-style-type: none"> The temperature difference between the target and the surroundings must be higher than 4°C. Movement speed: 1.0m/s Target concept: Human body with an approx. size of 700×250mm Target moving direction: Crossing the detection beam.

Wall installation type

CAD data

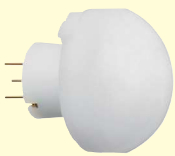

Detection distance	1st step lens	Max. 12m
	2nd step lens	Max. 6m
	3rd step lens	Max. 3m
Field of view	40°×105°	
Detection zone	68 beams	
Detection condition	<ul style="list-style-type: none"> The temperature difference between the target and the surroundings must be higher than 4°C. Movement speed: 1.0m/s Target concept: Human body with an approx. size of 700×250mm Target moving direction: Crossing the detection beam. 	

Lensless type



PIR element

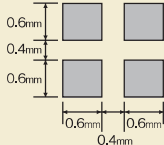

Detection sensitivity	Average: 5.6μW/cm ² Maximum: 7.6μW/cm ²
-----------------------	--

※Detection sensitivity is measured by following system

Test setup

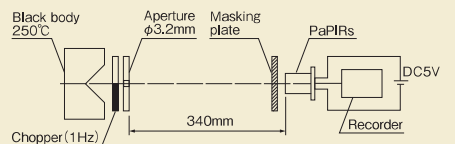

Horizontally wide detection type

Current consumption **1/2/6/170 μ A**

Digital output

> World's first PIR with "Approach Sensing" technology

Panasonic presents the world's first PIR sensor in the shape of a hammerhead with a special optic, which is more sensitive to radial motion.



Recommended applications

Wall switches, thermostats, IP cameras, wake-up switch for displays, intrusion alarm sensors (e.g. for windows and doors), door intercom systems, entrance and garden lamps, automatic door systems, vending machines



Horizontally wide detection type

Current consumption in standby mode (1 μ A type: in sleep mode)	1 μ A	2 μ A	6 μ A	170 μ A	
	Digital (open collector)				
Lens color	White	EKMB1105111	EKMB1205111	EKMB1305111K	EKMC1605111
	Black	EKMB1105112	EKMB1205112	EKMB1305112K	EKMC1605112
	Pearl white	EKMB1105113	EKMB1205113	EKMB1305113K	EKMC1605113

Dimension (mm)	Detection zone	Detection characteristics																		
<p>CAD data by request</p>		<table border="1"> <tr> <td>Detection distance</td> <td colspan="2">Max. 5m*</td> </tr> <tr> <td rowspan="2">Field of view</td> <td>Area A</td> <td>122° x 35°</td> </tr> <tr> <td>Area B</td> <td>150° x 20°</td> </tr> <tr> <td rowspan="2">Detection zone</td> <td>Area A</td> <td>88</td> </tr> <tr> <td>Area B</td> <td>16</td> </tr> <tr> <td rowspan="2">Detection condition ▲</td> <td>Area A</td> <td> <ul style="list-style-type: none"> The temperature difference between the target and the surroundings must be higher than 4°C. Movement speed: 1m/s Target concept: human head with an approx. size of 700x250mm Target moving direction: crossing 2 detection zones </td> </tr> <tr> <td>Area B</td> <td> <ul style="list-style-type: none"> The temperature difference between the target and the surroundings must be higher than 8°C. Movement speed: 1m/s Target concept: human body with an approx. size of 700x250mm Target moving direction: crossing 2 detection zones </td> </tr> </table>	Detection distance	Max. 5m*		Field of view	Area A	122° x 35°	Area B	150° x 20°	Detection zone	Area A	88	Area B	16	Detection condition ▲	Area A	<ul style="list-style-type: none"> The temperature difference between the target and the surroundings must be higher than 4°C. Movement speed: 1m/s Target concept: human head with an approx. size of 700x250mm Target moving direction: crossing 2 detection zones 	Area B	<ul style="list-style-type: none"> The temperature difference between the target and the surroundings must be higher than 8°C. Movement speed: 1m/s Target concept: human body with an approx. size of 700x250mm Target moving direction: crossing 2 detection zones
Detection distance	Max. 5m*																			
Field of view	Area A	122° x 35°																		
	Area B	150° x 20°																		
Detection zone	Area A	88																		
	Area B	16																		
Detection condition ▲	Area A	<ul style="list-style-type: none"> The temperature difference between the target and the surroundings must be higher than 4°C. Movement speed: 1m/s Target concept: human head with an approx. size of 700x250mm Target moving direction: crossing 2 detection zones 																		
	Area B	<ul style="list-style-type: none"> The temperature difference between the target and the surroundings must be higher than 8°C. Movement speed: 1m/s Target concept: human body with an approx. size of 700x250mm Target moving direction: crossing 2 detection zones 																		

* Under specified detection conditions
 ▲ Please refer to "Cautions for use" (page 18) and "Basic principles" (page 18, point 5), for more details

Please contact your local sales representative for detailed specifications.

Standard and slight motion detection type

Current consumption **1/2/6/170µA**

Digital output



> 2 functions in 1 lens

High Sensitivity Centre ZONE: Optimized for detecting small movements and small objects
 Normal Sensitivity Outer ZONE: Optimized for detecting larger movements of larger objects



Recommended applications

Lighting control, heaters, ventilators or air conditioners, IP cameras, intrusion alarms, digital signage, vending machines, multi-function printers, display panels for meeting rooms, PCs



Standard and slight motion detection type



► Current consumption in standby mode (1µA type: in sleep mode)	1µA	2µA	6µA	170µA	
	Digital (open collector)				
► Output	Digital (open collector)				
	White	EKMB1193111	EKMB1293111	EKMB1393111K	EKMC1693111
	Black	EKMB1193112	EKMB1293112	EKMB1393112K	EKMC1693112
► Lens color	Pearl white	EKMB1193113	EKMB1293113	EKMB1393113K	EKMC1693113

Dimension (mm)	Detection zone	Detection characteristics																		
<p>CAD data by request</p> <p>SECTION A-A</p>		<table border="1"> <tr> <td>Detection distance</td> <td colspan="2">Max. 2.2m*</td> </tr> <tr> <td rowspan="2">Field of view</td> <td>Slight motion</td> <td>44° x 44°</td> </tr> <tr> <td>Standard motion</td> <td>90° x 90°</td> </tr> <tr> <td rowspan="2">Detection zone</td> <td>Slight motion</td> <td>36</td> </tr> <tr> <td>Standard motion</td> <td>48</td> </tr> <tr> <td rowspan="2">Detection condition ▲</td> <td>Slight motion</td> <td> <ul style="list-style-type: none"> The temperature difference between the target and the surroundings must be higher than 4°C. Movement speed: 0.5m/s Target concept: human head with an approx. size of 200x200mm Target moving direction: crossing 1 detection zone </td> </tr> <tr> <td>Standard motion</td> <td> <ul style="list-style-type: none"> The temperature difference between the target and the surroundings must be higher than 4°C. Movement speed: 1.0m/s Target concept: human body with an approx. size of 400x200mm Target moving direction: crossing 2 detection zones </td> </tr> </table>	Detection distance	Max. 2.2m*		Field of view	Slight motion	44° x 44°	Standard motion	90° x 90°	Detection zone	Slight motion	36	Standard motion	48	Detection condition ▲	Slight motion	<ul style="list-style-type: none"> The temperature difference between the target and the surroundings must be higher than 4°C. Movement speed: 0.5m/s Target concept: human head with an approx. size of 200x200mm Target moving direction: crossing 1 detection zone 	Standard motion	<ul style="list-style-type: none"> The temperature difference between the target and the surroundings must be higher than 4°C. Movement speed: 1.0m/s Target concept: human body with an approx. size of 400x200mm Target moving direction: crossing 2 detection zones
Detection distance	Max. 2.2m*																			
Field of view	Slight motion	44° x 44°																		
	Standard motion	90° x 90°																		
Detection zone	Slight motion	36																		
	Standard motion	48																		
Detection condition ▲	Slight motion	<ul style="list-style-type: none"> The temperature difference between the target and the surroundings must be higher than 4°C. Movement speed: 0.5m/s Target concept: human head with an approx. size of 200x200mm Target moving direction: crossing 1 detection zone 																		
	Standard motion	<ul style="list-style-type: none"> The temperature difference between the target and the surroundings must be higher than 4°C. Movement speed: 1.0m/s Target concept: human body with an approx. size of 400x200mm Target moving direction: crossing 2 detection zones 																		

* Under specified detection conditions
 ▲ Please refer to "Cautions for use" (page 18) and "Basic principles" (page 18, point 5), for more details

Please contact your local sales representative for detailed specifications.

Mouser Electronics

Authorized Distributor

Click to View Pricing, Inventory, Delivery & Lifecycle Information:

Panasonic:

[EKMC1601111](#) [EKMC1601112](#) [EKMC1601113](#) [EKMC1603111](#) [EKMC1603112](#) [EKMC1603113](#) [EKMC1604112](#)
[EKMC1604113](#) [EKMC1604111](#) [EKMC1672112](#) [EKMC1672111](#)

Компания «Life Electronics» занимается поставками электронных компонентов импортного и отечественного производства от производителей и со складов крупных дистрибьюторов Европы, Америки и Азии.

С конца 2013 года компания активно расширяет линейку поставок компонентов по направлению коаксиальный кабель, кварцевые генераторы и конденсаторы (керамические, пленочные, электролитические), за счёт заключения дистрибьюторских договоров

Мы предлагаем:

- Конкурентоспособные цены и скидки постоянным клиентам.
- Специальные условия для постоянных клиентов.
- Подбор аналогов.
- Поставку компонентов в любых объемах, удовлетворяющих вашим потребностям.
- Приемлемые сроки поставки, возможна ускоренная поставка.
- Доставку товара в любую точку России и стран СНГ.
- Комплексную поставку.
- Работу по проектам и поставку образцов.
- Формирование склада под заказчика.
- Сертификаты соответствия на поставляемую продукцию (по желанию клиента).
- Тестирование поставляемой продукции.
- Поставку компонентов, требующих военную и космическую приемку.
- Входной контроль качества.
- Наличие сертификата ISO.

В составе нашей компании организован Конструкторский отдел, призванный помогать разработчикам, и инженерам.

Конструкторский отдел помогает осуществить:

- Регистрацию проекта у производителя компонентов.
- Техническую поддержку проекта.
- Защиту от снятия компонента с производства.
- Оценку стоимости проекта по компонентам.
- Изготовление тестовой платы монтаж и пусконаладочные работы.



Тел: +7 (812) 336 43 04 (многоканальный)

Email: org@lifeelectronics.ru