

NSS20200LT1G, NSV20200LT1G

20 V, 4.0 A, Low $V_{CE(sat)}$ PNP Transistor

ON Semiconductor's e²PowerEdge family of low $V_{CE(sat)}$ transistors are miniature surface mount devices featuring ultra low saturation voltage ($V_{CE(sat)}$) and high current gain capability. These are designed for use in low voltage, high speed switching applications where affordable efficient energy control is important.

Typical applications are DC-DC converters and power management in portable and battery powered products such as cellular and cordless phones, PDAs, computers, printers, digital cameras and MP3 players. Other applications are low voltage motor controls in mass storage products such as disc drives and tape drives. In the automotive industry they can be used in air bag deployment and in the instrument cluster. The high current gain allows e²PowerEdge devices to be driven directly from PMU's control outputs, and the Linear Gain (Beta) makes them ideal components in analog amplifiers.

Features

- NSV Prefix for Automotive and Other Applications Requiring Unique Site and Control Change Requirements; AEC-Q101 Qualified and PPAP Capable
- These Devices are Pb-Free, Halogen Free/BFR Free and are RoHS Compliant



ON Semiconductor®

www.onsemi.com

-20 VOLTS
4.0 AMPS
PNP LOW $V_{CE(sat)}$ TRANSISTOR
EQUIVALENT $R_{DS(on)}$ 65 m Ω

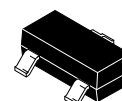

SOT-23 (TO-236)
CASE 318
STYLE 6

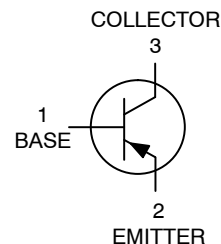

MARKING DIAGRAM

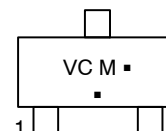

VC = Specific Device Code
M = Date Code*
▪ = Pb-Free Package

(Note: Microdot may be in either location)
*Date Code orientation and/or overbar may vary depending upon manufacturing location.

ORDERING INFORMATION

| Device | Package | Shipping [†] |
|--------------|---------------------|------------------------|
| NSS20200LT1G | SOT-23 (Pb-Free) | 3,000 / Tape & Reel |
| NSV20200LT1G | SOT-23 (Pb-Free) | 3,000 / Tape & Reel |

[†]For information on tape and reel specifications, including part orientation and tape sizes, please refer to our Tape and Reel Packaging Specification Brochure, BRD8011/D.

NSS20200LT1G, NSV20200LT1G

MAXIMUM RATINGS (T_A = 25°C)

| Rating | Symbol | Max | Unit |
|--------------------------------|------------------|----------------------------|------|
| Collector-Emitter Voltage | V _{CEO} | -20 | Vdc |
| Collector-Base Voltage | V _{CBO} | -20 | Vdc |
| Emitter-Base Voltage | V _{EBO} | -7.0 | Vdc |
| Collector Current – Continuous | I _C | -2.0 | A |
| Collector Current – Peak | I _{CM} | -4.0 | A |
| Electrostatic Discharge | ESD | HBM Class 3B MM Class C | |

THERMAL CHARACTERISTICS

| Characteristic | Symbol | Max | Unit |
|--|-----------------------------------|-------------|-------------|
| Total Device Dissipation T _A = 25°C Derate above 25°C | P _D (Note 1) | 460 3.7 | mW mW/°C |
| Thermal Resistance, Junction-to-Ambient | R _{θJA} (Note 1) | 270 | °C/W |
| Total Device Dissipation T _A = 25°C Derate above 25°C | P _D (Note 2) | 540 4.3 | mW mW/°C |
| Thermal Resistance, Junction-to-Ambient | R _{θJA} (Note 2) | 230 | °C/W |
| Total Device Dissipation (Single Pulse < 10 sec.) | P _{Dsingle} (Note 3) | 710 | mW |
| Junction and Storage Temperature Range | T _J , T _{stg} | -55 to +150 | °C |

Stresses exceeding those listed in the Maximum Ratings table may damage the device. If any of these limits are exceeded, device functionality should not be assumed, damage may occur and reliability may be affected.

1. FR-4 @ 100 mm², 1 oz. copper traces.
2. FR-4 @ 500 mm², 1 oz. copper traces.
3. Thermal response.

NSS20200LT1G, NSV20200LT1G

ELECTRICAL CHARACTERISTICS (T_A = 25°C unless otherwise noted)

| Characteristic | Symbol | Min | Typ | Max | Unit |
|----------------|--------|-----|-----|-----|------|
|----------------|--------|-----|-----|-----|------|

OFF CHARACTERISTICS

| | | | | | |
|--|----------------------|------|---|------|------|
| Collector – Emitter Breakdown Voltage (I _C = -10 mA, I _B = 0) | V _{(BR)CEO} | -20 | - | - | Vdc |
| Collector – Base Breakdown Voltage (I _C = -0.1 mA, I _E = 0) | V _{(BR)CBO} | -20 | - | - | Vdc |
| Emitter – Base Breakdown Voltage (I _E = -0.1 mA, I _C = 0) | V _{(BR)EBO} | -7.0 | - | - | Vdc |
| Collector Cutoff Current (V _{CB} = -20 Vdc, I _E = 0) | I _{CBO} | - | - | -0.1 | μAdc |
| Emitter Cutoff Current (V _{EB} = -7.0 Vdc) | I _{EBO} | - | - | -0.1 | μAdc |

ON CHARACTERISTICS

| | | | | | |
|--|----------------------|--------------------------|--------------------------------------|--------------------------------------|-----|
| DC Current Gain (Note 4) (I _C = -10 mA, V _{CE} = -2.0 V) (I _C = -500 mA, V _{CE} = -2.0 V) (I _C = -1.0 A, V _{CE} = -2.0 V) (I _C = -2.0 A, V _{CE} = -2.0 V) | h _{FE} | 250 250 180 150 | - 300 - - | - - - - | |
| Collector – Emitter Saturation Voltage (Note 4) (I _C = -0.1 A, I _B = -0.010 A) (Note 5) (I _C = -1.0 A, I _B = -0.100 A) (I _C = -1.0 A, I _B = -0.010 A) (I _C = -2.0 A, I _B = -0.200 A) | V _{CE(sat)} | - - - - | -0.008 -0.065 -0.100 -0.130 | -0.013 -0.090 -0.120 -0.180 | V |
| Base – Emitter Saturation Voltage (Note 4) (I _C = -1.0 A, I _B = -0.01 A) | V _{BE(sat)} | - | - | -0.900 | V |
| Base – Emitter Turn-on Voltage (Note 4) (I _C = -1.0 A, V _{CE} = -2.0 V) | V _{BE(on)} | - | - | -0.900 | V |
| Cutoff Frequency (I _C = -100 mA, V _{CE} = -5.0 V, f = 100 MHz) | f _T | 100 | - | - | MHz |
| Input Capacitance (V _{EB} = 0.5 V, f = 1.0 MHz) | C _{ibo} | - | - | 330 | pF |
| Output Capacitance (V _{CB} = 3.0 V, f = 1.0 MHz) | C _{obo} | - | - | 100 | pF |

SWITCHING CHARACTERISTICS

| | | | | | |
|---|----------------|---|---|-----|----|
| Delay (V _{CC} = -15 V, I _C = 750 mA, I _{B1} = 15 mA) | t _d | - | - | 60 | ns |
| Rise (V _{CC} = -15 V, I _C = 750 mA, I _{B1} = 15 mA) | t _r | - | - | 120 | ns |
| Storage (V _{CC} = -15 V, I _C = 750 mA, I _{B1} = 15 mA) | t _s | - | - | 300 | ns |
| Fall (V _{CC} = -15 V, I _C = 750 mA, I _{B1} = 15 mA) | t _f | - | - | 130 | ns |

Product parametric performance is indicated in the Electrical Characteristics for the listed test conditions, unless otherwise noted. Product performance may not be indicated by the Electrical Characteristics if operated under different conditions.

4. Pulsed Condition: Pulse Width = 300 msec, Duty Cycle ≤ 2%.
5. Guaranteed by design but not tested.

NSS20200LT1G, NSV20200LT1G

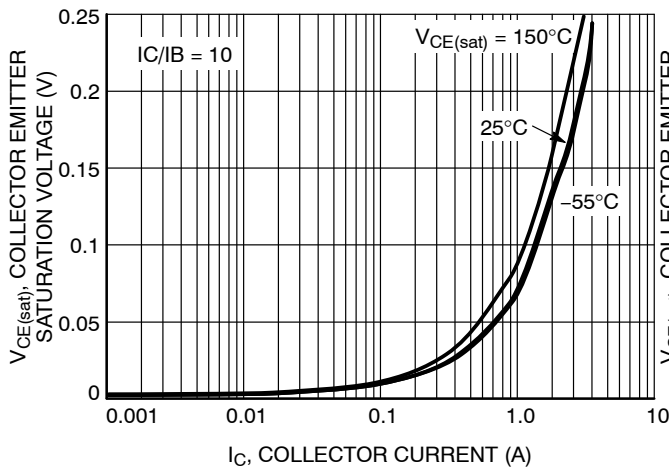

Figure 1. Collector Emitter Saturation Voltage vs. Collector Current

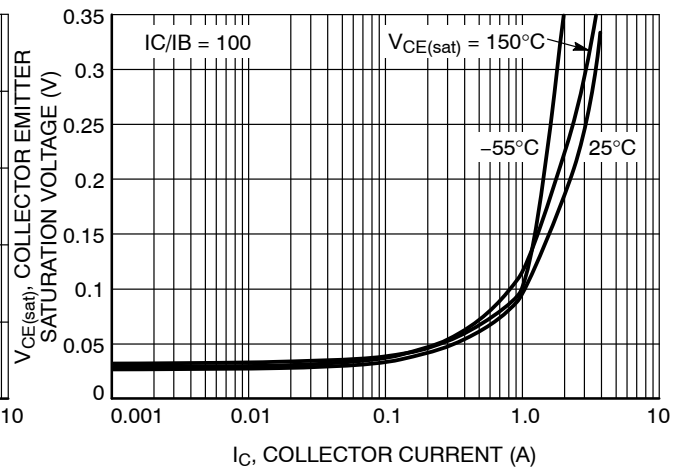

Figure 2. Collector Emitter Saturation Voltage vs. Collector Current

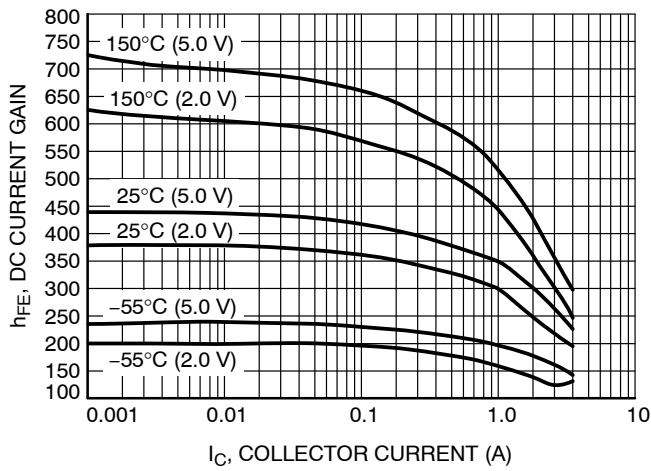

Figure 3. DC Current Gain vs. Collector Current

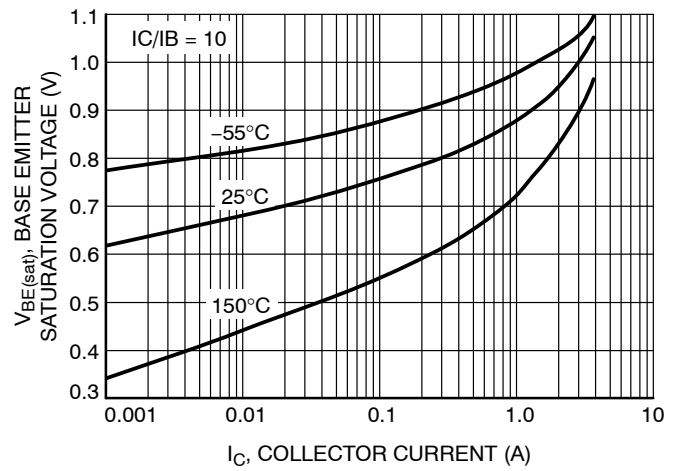

Figure 4. Base Emitter Saturation Voltage vs. Collector Current

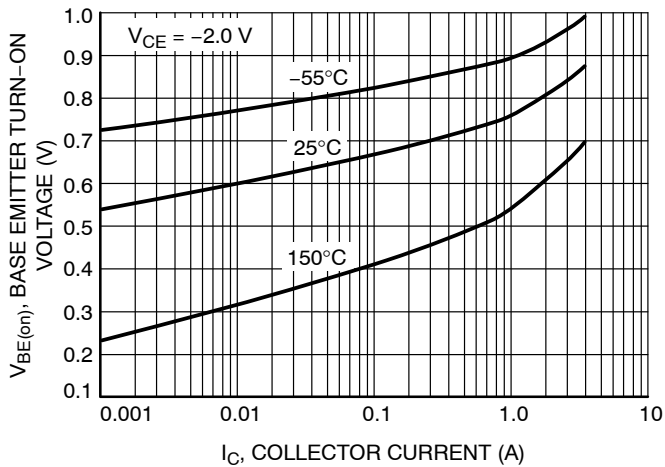

Figure 5. Base Emitter Turn-On Voltage vs. Collector Current

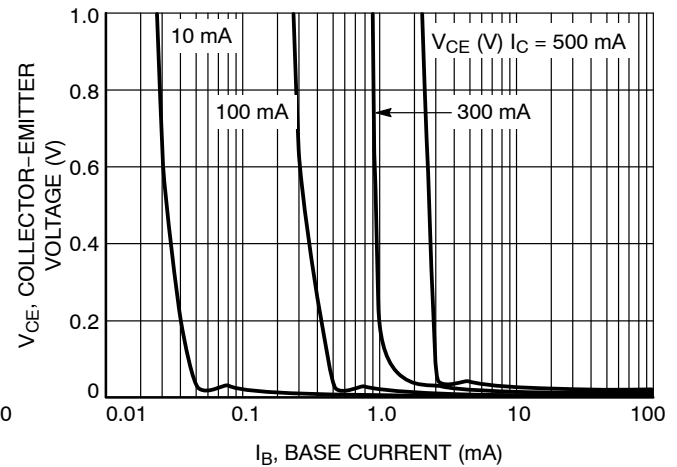

Figure 6. Saturation Region

NSS20200LT1G, NSV20200LT1G

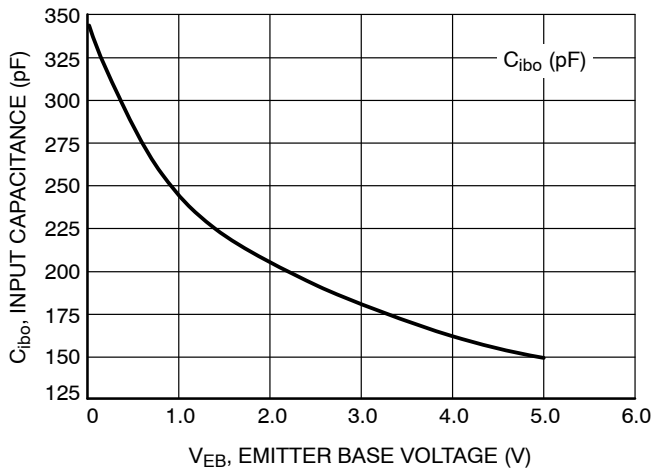

Figure 7. Input Capacitance

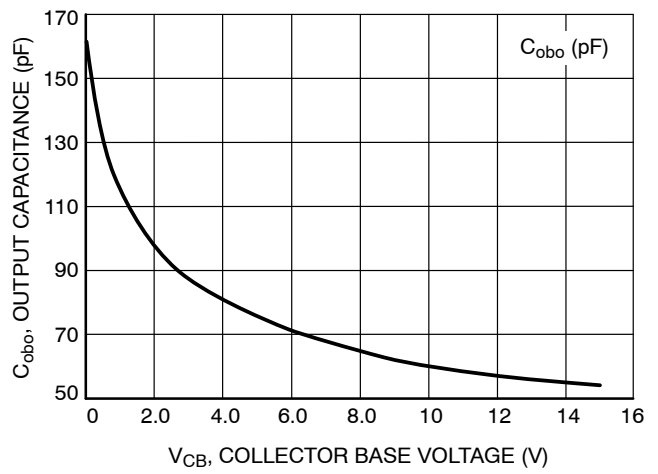

Figure 8. Output Capacitance

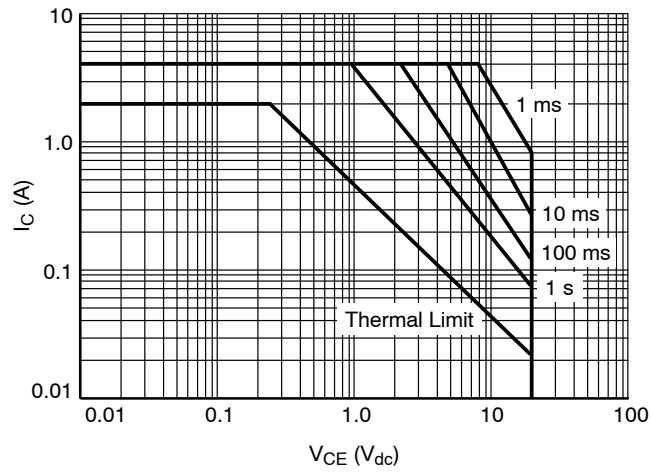
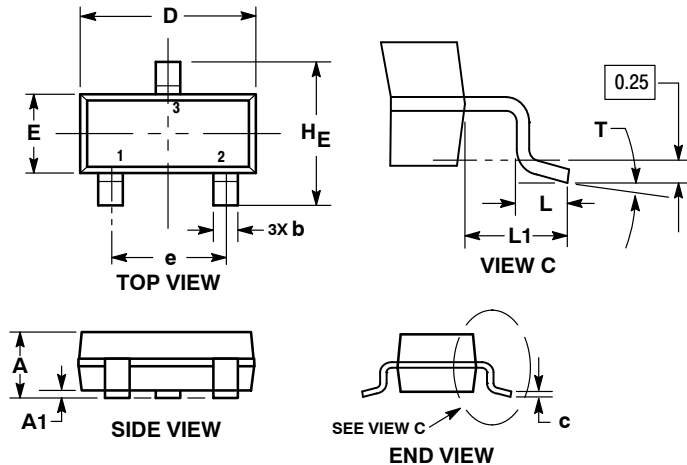

Figure 9. Safe Operating Area

NSS20200LT1G, NSV20200LT1G

PACKAGE DIMENSIONS

SOT-23 (TO-236)
CASE 318-08
ISSUE AR



NOTES:

1. DIMENSIONING AND TOLERANCING PER ASME Y14.5M, 1994.
2. CONTROLLING DIMENSION: MILLIMETERS.
3. MAXIMUM LEAD THICKNESS INCLUDES LEAD FINISH. MINIMUM LEAD THICKNESS IS THE MINIMUM THICKNESS OF THE BASE MATERIAL.
4. DIMENSIONS D AND E DO NOT INCLUDE MOLD FLASH, PROTRUSIONS, OR GATE BURRS.

| DIM | MILLIMETERS | | | INCHES | | |
|-----|-------------|------|------|--------|-------|-------|
| | MIN | NOM | MAX | MIN | NOM | MAX |
| A | 0.89 | 1.00 | 1.11 | 0.035 | 0.039 | 0.044 |
| A1 | 0.01 | 0.06 | 0.10 | 0.000 | 0.002 | 0.004 |
| b | 0.37 | 0.44 | 0.50 | 0.015 | 0.017 | 0.020 |
| c | 0.08 | 0.14 | 0.20 | 0.003 | 0.006 | 0.008 |
| D | 2.80 | 2.90 | 3.04 | 0.110 | 0.114 | 0.120 |
| E | 1.20 | 1.30 | 1.40 | 0.047 | 0.051 | 0.055 |
| e | 1.78 | 1.90 | 2.04 | 0.070 | 0.075 | 0.080 |
| L | 0.30 | 0.43 | 0.55 | 0.012 | 0.017 | 0.022 |
| L1 | 0.35 | 0.54 | 0.69 | 0.014 | 0.021 | 0.027 |
| HE | 2.10 | 2.40 | 2.64 | 0.083 | 0.094 | 0.104 |
| T | 0° | --- | 10° | 0° | --- | 10° |

STYLE 6:

1. BASE
2. EMITTER
3. COLLECTOR

RECOMMENDED SOLDERING FOOTPRINT*

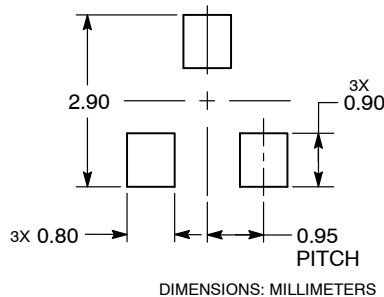

*For additional information on our Pb-Free strategy and soldering details, please download the ON Semiconductor Soldering and Mounting Techniques Reference Manual, SOLDERRM/D.

ON Semiconductor and are trademarks of Semiconductor Components Industries, LLC dba ON Semiconductor or its subsidiaries in the United States and/or other countries. ON Semiconductor owns the rights to a number of patents, trademarks, copyrights, trade secrets, and other intellectual property. A listing of ON Semiconductor's product/patent coverage may be accessed at www.onsemi.com/site/pdf/Patent-Marking.pdf. ON Semiconductor reserves the right to make changes without further notice to any products herein. ON Semiconductor makes no warranty, representation or guarantee regarding the suitability of its products for any particular purpose, nor does ON Semiconductor assume any liability arising out of the application or use of any product or circuit, and specifically disclaims any and all liability, including without limitation special, consequential or incidental damages. Buyer is responsible for its products and applications using ON Semiconductor products, including compliance with all laws, regulations and safety requirements or standards, regardless of any support or applications information provided by ON Semiconductor. "Typical" parameters which may be provided in ON Semiconductor data sheets and/or specifications can and do vary in different applications and actual performance may vary over time. All operating parameters, including "Typicals" must be validated for each customer application by customer's technical experts. ON Semiconductor does not convey any license under its patent rights nor the rights of others. ON Semiconductor products are not designed, intended, or authorized for use as a critical component in life support systems or any FDA Class 3 medical devices or medical devices with a same or similar classification in a foreign jurisdiction or any devices intended for implantation in the human body. Should Buyer purchase or use ON Semiconductor products for any such unintended or unauthorized application, Buyer shall indemnify and hold ON Semiconductor and its officers, employees, subsidiaries, affiliates, and distributors harmless against all claims, costs, damages, and expenses, and reasonable attorney fees arising out of, directly or indirectly, any claim of personal injury or death associated with such unintended or unauthorized use, even if such claim alleges that ON Semiconductor was negligent regarding the design or manufacture of the part. ON Semiconductor is an Equal Opportunity/Affirmative Action Employer. This literature is subject to all applicable copyright laws and is not for resale in any manner.

PUBLICATION ORDERING INFORMATION

LITERATURE FULFILLMENT:
Literature Distribution Center for ON Semiconductor
19521 E. 32nd Pkwy, Aurora, Colorado 80011 USA
Phone: 303-675-2175 or 800-344-3860 Toll Free USA/Canada
Fax: 303-675-2176 or 800-344-3867 Toll Free USA/Canada
Email: orderlit@onsemi.com

N. American Technical Support: 800-282-9855 Toll Free
USA/Canada
Europe, Middle East and Africa Technical Support:
Phone: 421 33 790 2910
Japan Customer Focus Center
Phone: 81-3-5817-1050

ON Semiconductor Website: www.onsemi.com
Order Literature: <http://www.onsemi.com/orderlit>

For additional information, please contact your local Sales Representative

Компания «Life Electronics» занимается поставками электронных компонентов импортного и отечественного производства от производителей и со складов крупных дистрибьюторов Европы, Америки и Азии.

С конца 2013 года компания активно расширяет линейку поставок компонентов по направлению коаксиальный кабель, кварцевые генераторы и конденсаторы (керамические, пленочные, электролитические), за счёт заключения дистрибьюторских договоров

Мы предлагаем:

- Конкурентоспособные цены и скидки постоянным клиентам.
- Специальные условия для постоянных клиентов.
- Подбор аналогов.
- Поставку компонентов в любых объемах, удовлетворяющих вашим потребностям.
- Приемлемые сроки поставки, возможна ускоренная поставка.
- Доставку товара в любую точку России и стран СНГ.
- Комплексную поставку.
- Работу по проектам и поставку образцов.
- Формирование склада под заказчика.
- Сертификаты соответствия на поставляемую продукцию (по желанию клиента).
- Тестирование поставляемой продукции.
- Поставку компонентов, требующих военную и космическую приемку.
- Входной контроль качества.
- Наличие сертификата ISO.

В составе нашей компании организован Конструкторский отдел, призванный помогать разработчикам, и инженерам.

Конструкторский отдел помогает осуществить:

- Регистрацию проекта у производителя компонентов.
- Техническую поддержку проекта.
- Защиту от снятия компонента с производства.
- Оценку стоимости проекта по компонентам.
- Изготовление тестовой платы монтаж и пусконаладочные работы.



Тел: +7 (812) 336 43 04 (многоканальный)

Email: org@lifeelectronics.ru