

### Product Description

The QPF4005 is a dual-channel multi-function Gallium Nitride MMIC front-end module targeted for 39GHz phased array 5G base stations and terminals. For each channel a multi-function MMIC die combines a low noise amplifier, a low insertion-loss high-isolation TR switch, and a high-gain high-efficiency multi-stage PA.

The QPF4005 operates from 37 GHz to 40.5 GHz range. The receive path (LNA + T/R SW) is designed to provide 15dB of gain and a noise figure less than 4.5dB. The transmit path (PA + T/R SW) provides 18 dB of small signal gain and a saturated output power of 2W each channel.

The compact 4.5 mm x 6.0 mm surface mount package configuration is designed to meet the tight lattice spacing requirements and support multi-channel/dual-polarization phased array applications.

The QPF4005 is fabricated on Qorvo’s 0.15um GaN on SiC process. It is housed in an air-cavity laminate package with an embedded copper heat slug. The copper slug, coupled with a low thermal resistance die-attach process, allows the QPF4005 to operate at the extreme case temperatures needed in phased array applications.

### Product Features

- Frequency Range: 37 – 40.5 GHz <sup>1</sup>
- RX Noise Figure: 4.2 dB
- RX Small Signal Gain: 18 dB
- RX Saturated Power: 17 dBm
- RX TOI : 20 dBm @ - 5 dBm Pin / tone
- TX Small Signal Gain: 23 dB
- TX Saturated Power: 33 dBm
- TX TOI: 42 dBm @ 24 dBm Pout / tone
- TX ACPR: 32dBc @ 24dBm average Pout <sup>2</sup>
- TX Linearity: 4% EVM @ 24 dBm average Pout <sup>2</sup>
- TX PAE: 7% @ 24 dBm average Pout.
- Package Dimensions: 4.5 x 6.0 x 1.8 mm

1. Performance is typical at room temperature.
2. OFDM, 400 MHz modulation bandwidth, 64QAM.

### Applications

- 5G Wireless Base stations and terminals
- Point to Point Communications

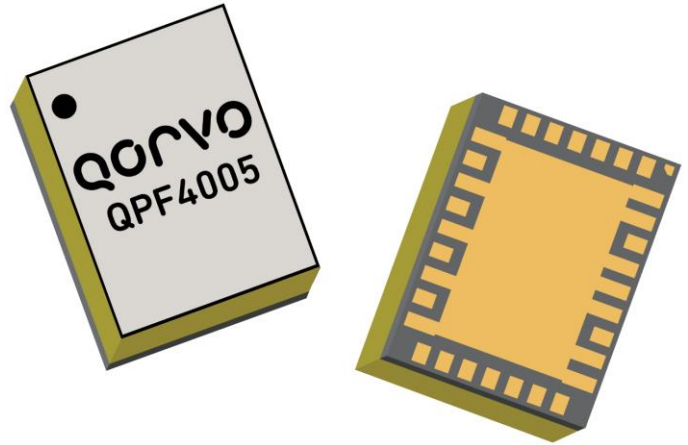

### Functional Block Diagram

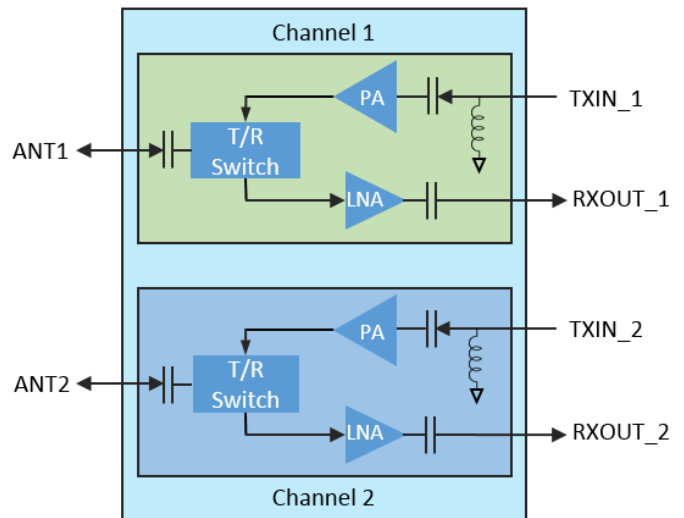

Part No.	Description
QPF4005SR	Tape and Reel, Qty 100
QPF4005EVB03	QPF4005 Evaluation Board, Qty 1

## Normal Operating Conditions

Parameter	Value
Drain Voltage (TXVD, RXVD) <sup>1, 2, 5</sup>	20 V
Drain Current (TXIDQ12 / TXIDQ3)	135 mA / 24 mA <sup>4</sup>
Drain Current (RXIDQ)	15 mA
Gate Voltage (TXVG12 / TXVG3) <sup>3</sup>	-2 V / -2.4 V
Gate Voltage (RXVG) <sup>3</sup>	-2 V
Control Voltage (TXSW, RXSW)	TXSW = 0 V, RXSW = 20V (RX on, TX off) TXSW = 20 V, RXSW = 0V (RX off, TX on)
Operating Temperature Range	-40 to 95 °C

- 1 Electrical specifications are measured at specified test conditions, no guarantee over all recommended operating conditions
- 2 Suffixes for channel ID removed from pin labels, both channels use the same settings
- 3 Gate voltages shown are typical, can be adjusted to set required drain current
- 4 Other current settings: 45 / 60 mA = 105 mA; 90 / 120 mA = 210 mA; 135 / 180 mA = 315 mA (gate controls combined together)
- 5 When in TX mode, the drain of receive channel is turned off by an internal switch.

## Electrical Specifications RX

Test conditions, unless otherwise noted: VD = 20 V, IDQ = 15 mA. Data de-embedded to device reference planes, 25 °C

Parameter	Min	Typical	Max	Units
Frequency	37		40.5	GHz
Small Signal Gain		18		dB
Noise Figure		4.2		dB
Saturated Output Power		17		dBm
Input Return Loss		12		dB
Output Return Loss		15		dB
Output TOI, @ -5 dBm Pin / tone, 10 MHz tone spacing		20		dBm
Gain Temperature Coefficient		-0.056		dB/°C

## Electrical Specifications TX

Test conditions unless otherwise noted: VD = 20 V, TXIDQ12 / TXIDQ3 = 135mA / 24 mA  
Data de-embedded to device reference planes, 25 °C

Parameter	Min	Typical	Max	Units
Frequency	37		40.5	GHz
Small Signal Gain		23		dB
Saturated Output Power		33		dBm
Input Return Loss		12		dB
Output Return Loss		13		dB
Output TOI, @ 24dBm Pout / tone, 10 MHz tone spacing		42		dBm
ACPR (24 dBm average power, OFDM, 400MHz, 64QAM)		-32		dBc
EVM (24 dBm average power, OFDM, 400MHz, 64QAM)		4		%
PAE at average output power (24dBm)		7		%
Gain Temperature Coefficient		-0.112		dB/°C

Performance Plots, Small Signal, Receive Path

Test Conditions unless otherwise stated: RXVD = 20 V, RXIDQ = 15 mA, 25C

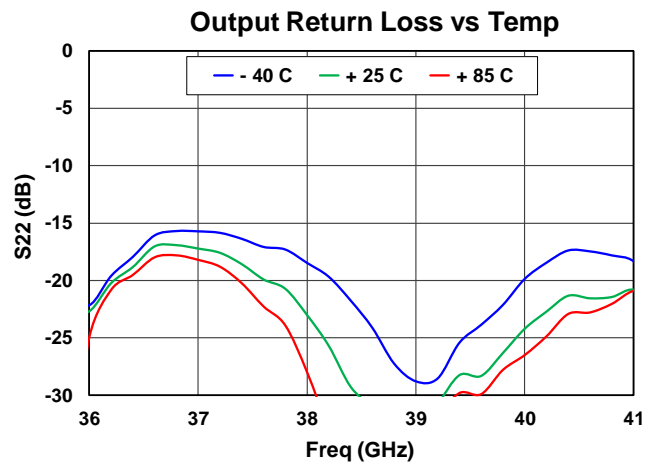
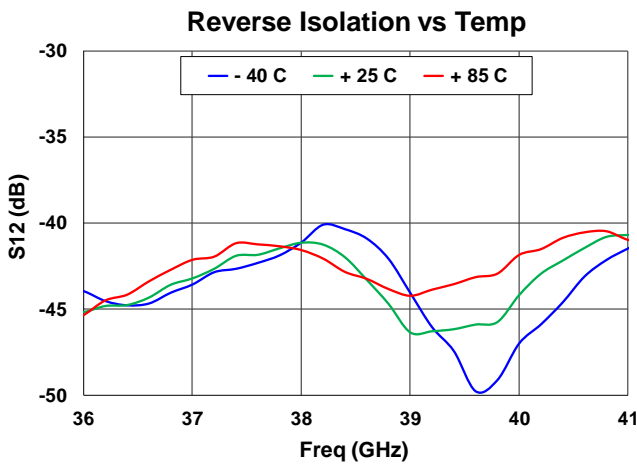
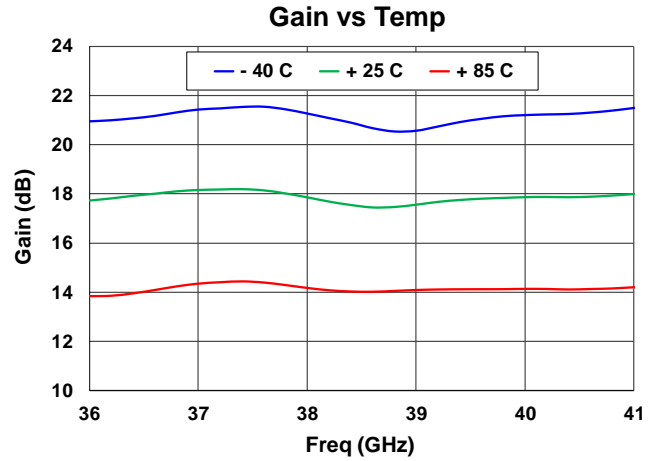
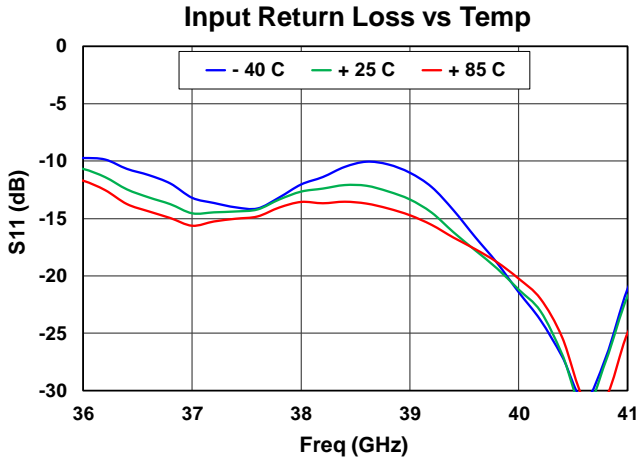

### Performance Plots, Small Signal, Receive Path

Test Conditions unless otherwise stated: RXVD = 20 V, RXIDQ = 15 mA, 25 C

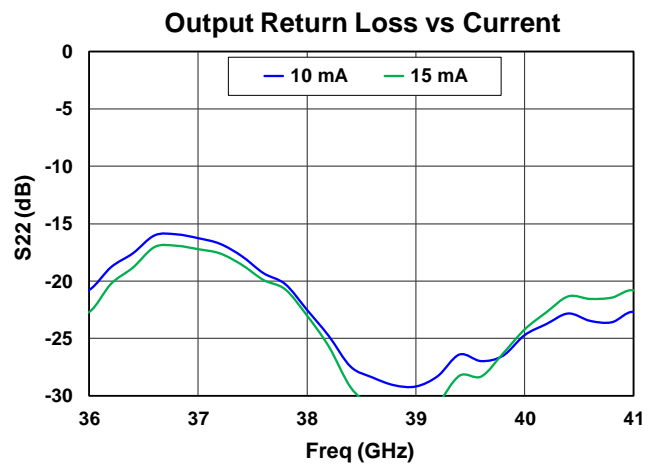
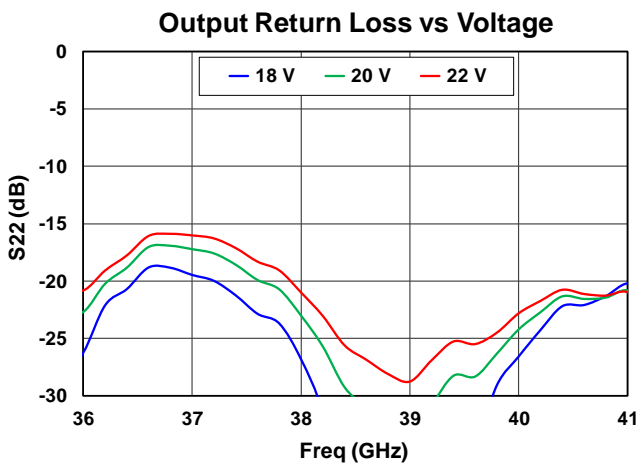
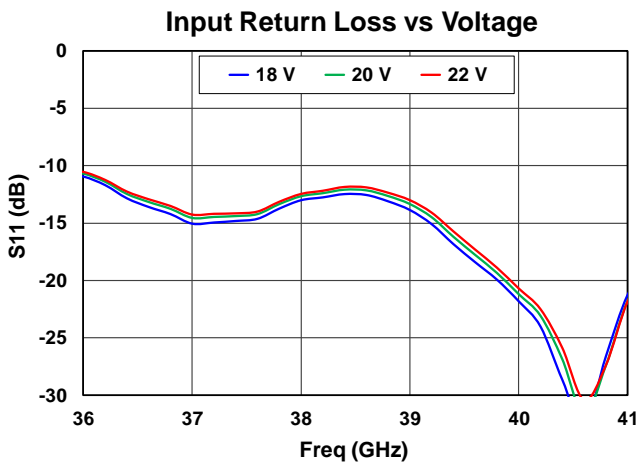
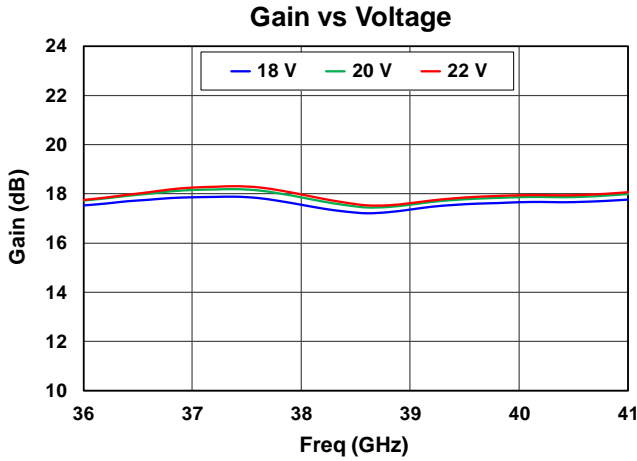

Performance Plots, Noise Figure, Receive Path

Test Conditions unless otherwise stated: RXVD = 20 V, RXIDQ = 15 mA, 25 C

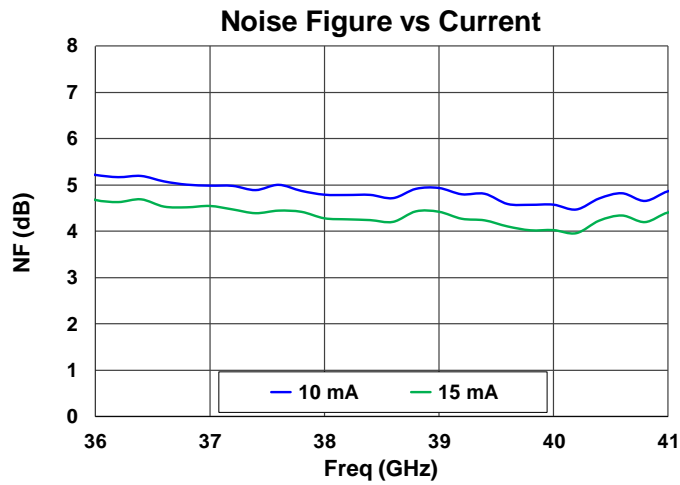
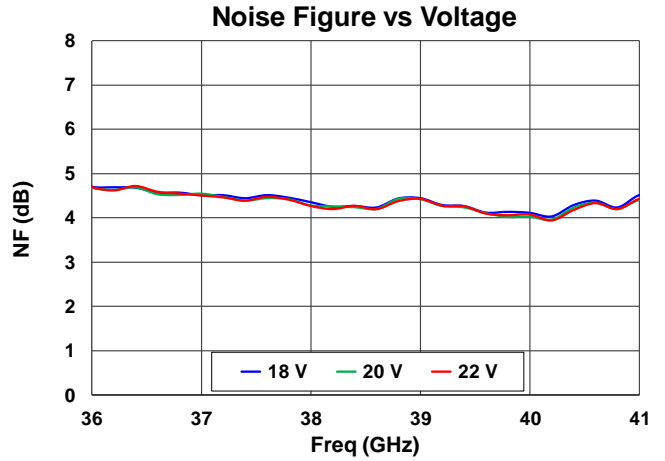

Performance Plots, Large Signal, Receive Path

Test Conditions unless otherwise stated: RXVD = 20 V, RXIDQ = 15 mA, CW, 25 C

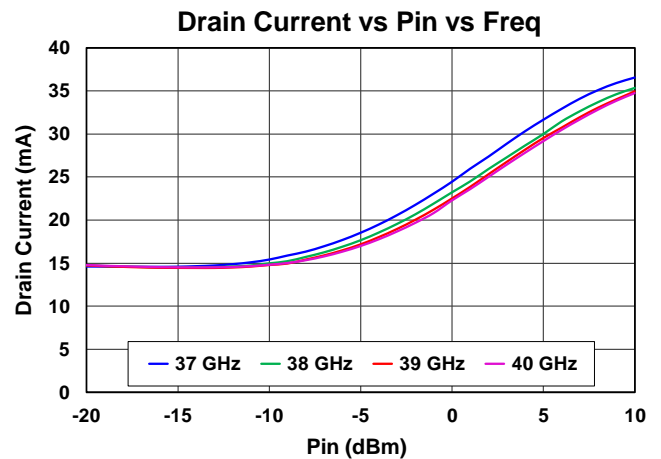
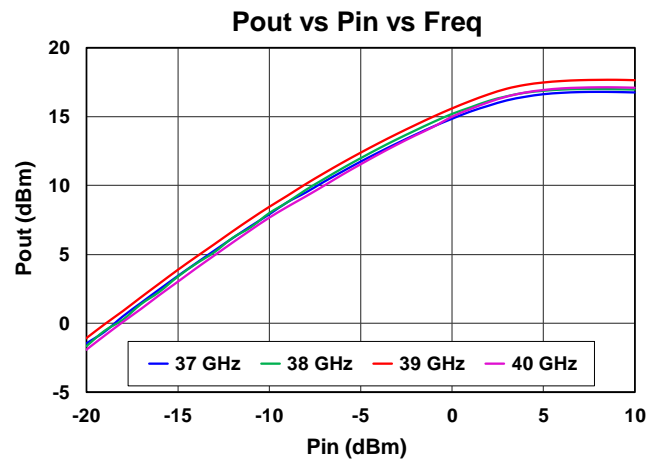
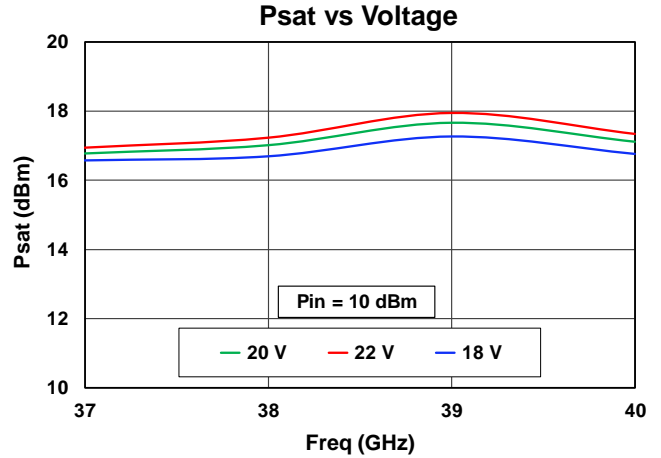

## Performance Plots, Linearity, Receive Path

Test Conditions unless otherwise stated: RXVD = 20 V, RXIDQ = 15 mA, Tone spacing: 10 MHz, 25 C



## Performance Plots, Small Signal, Transmit Path

Test Conditions unless otherwise stated: TXVD = 20 V, TXIDQ12 = 135 mA, TXIDQ3 = 24 mA

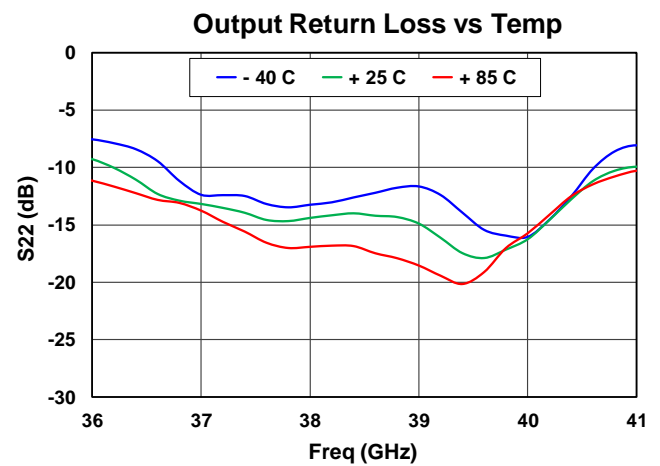
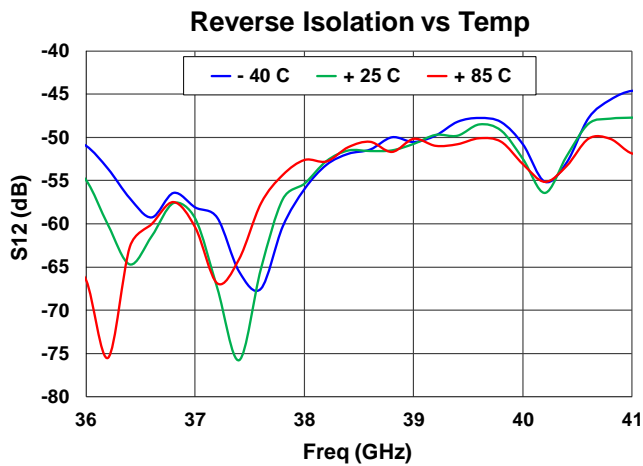
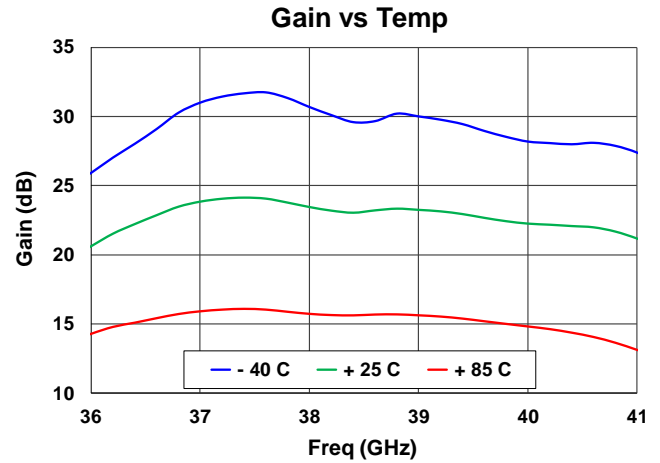
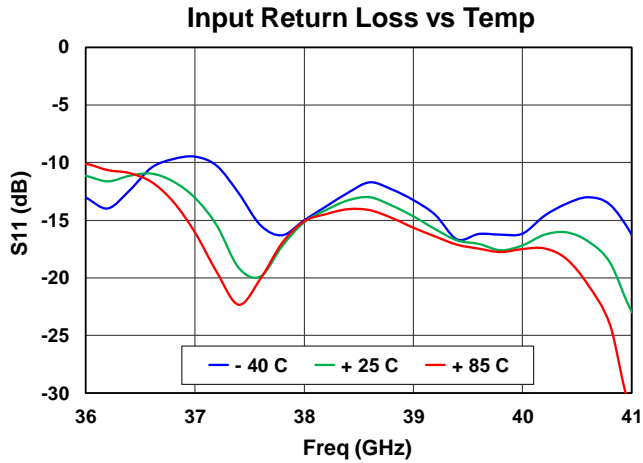



### Performance Plots, Small Signal, Transmit Path

Test Conditions unless otherwise stated: TXVD = 20 V, 25 C

TXIDQ12 = 135 mA, TXIDQ3 = 24 mA (159mA), for other bias conditions refer to Nominal Operating Condition table in page 2

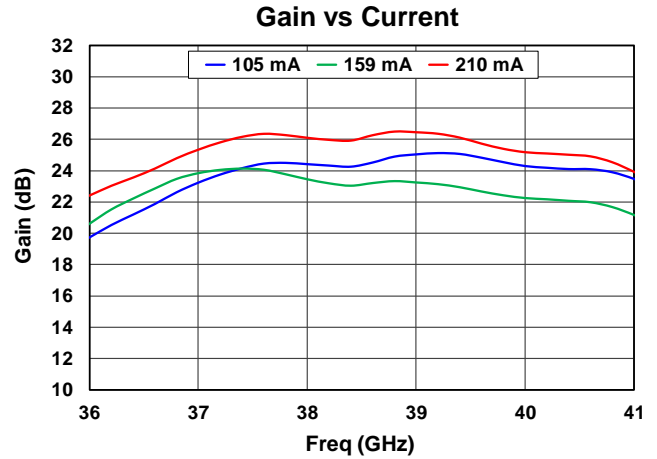
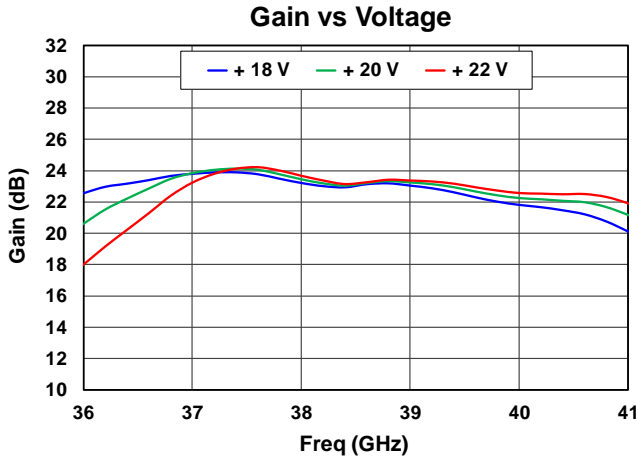

### Performance Plots, Large Signal, Transmit Path

Test Conditions unless otherwise stated: TXVD = 20 V, 25 C, Pin = 20 dBm  
 TXIDQ12 = 135 mA, TXIDQ3 = 24 mA (159mA), for other bias conditions refer to Nominal Operating Condition table in page 2

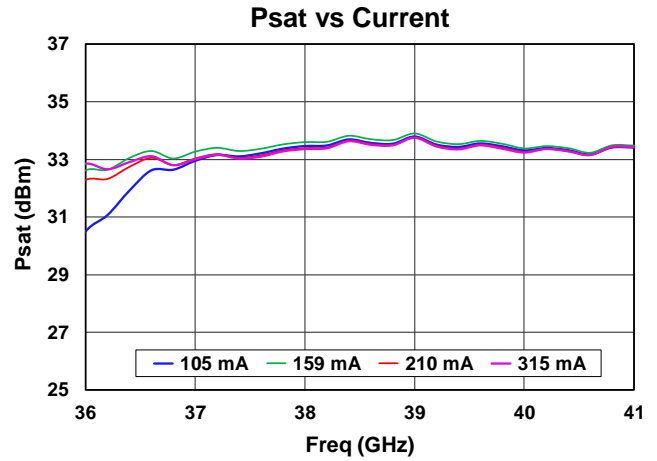
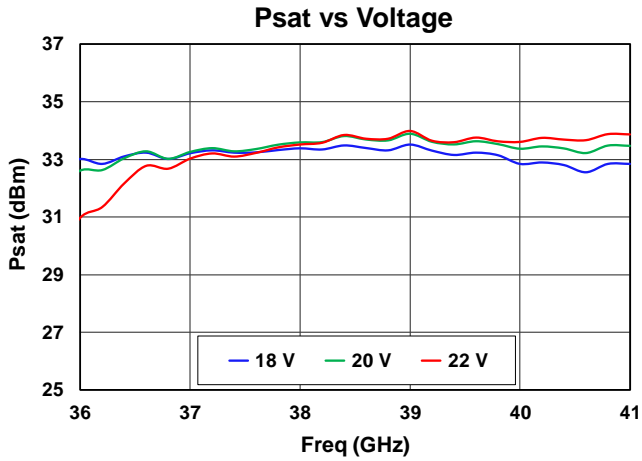

### Performance Plots, Large Signal, Transmit Path

Test Conditions unless otherwise stated: TXVD = 20 V, TXIDQ12 = 135 mA, TXIDQ3 = 24 mA,  
Pulse Mode: PW = 100 uS, DC = 10%, 25C

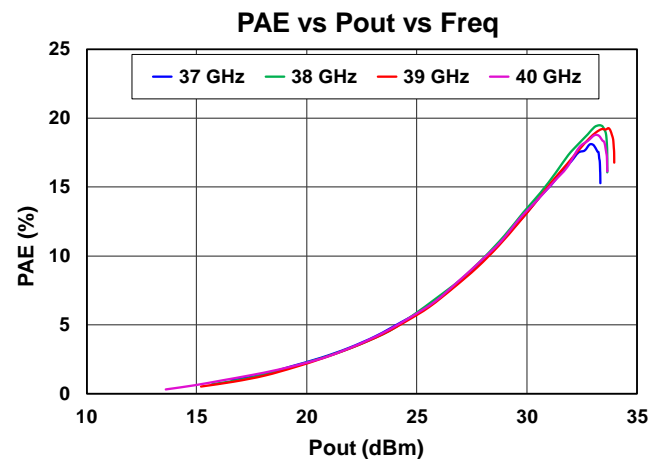
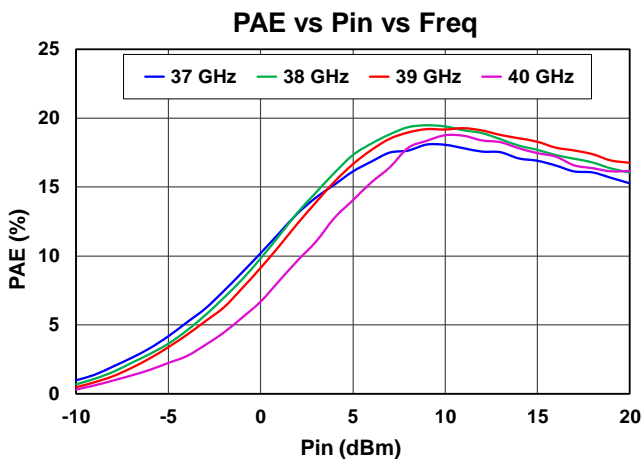
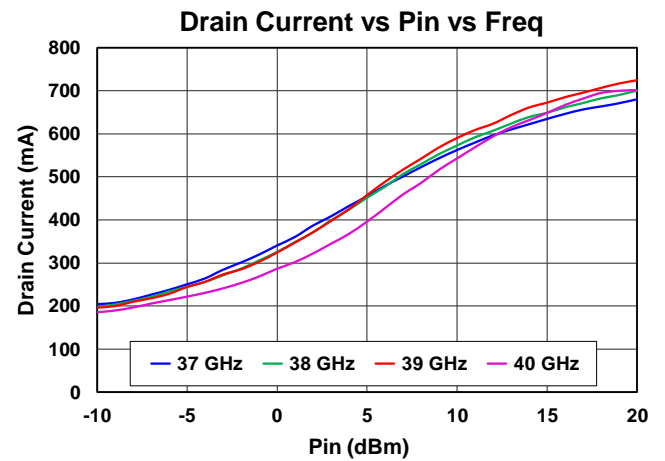
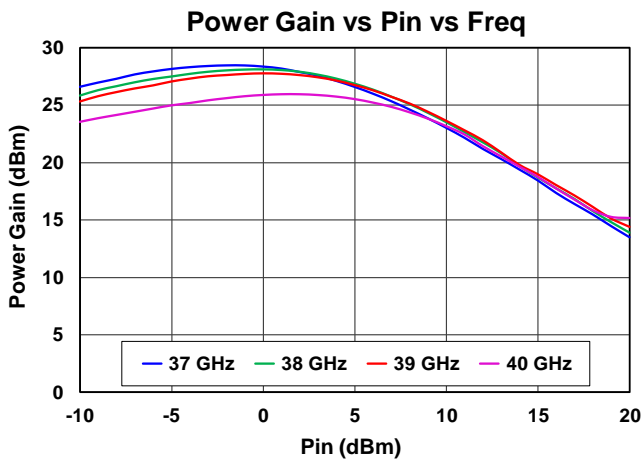
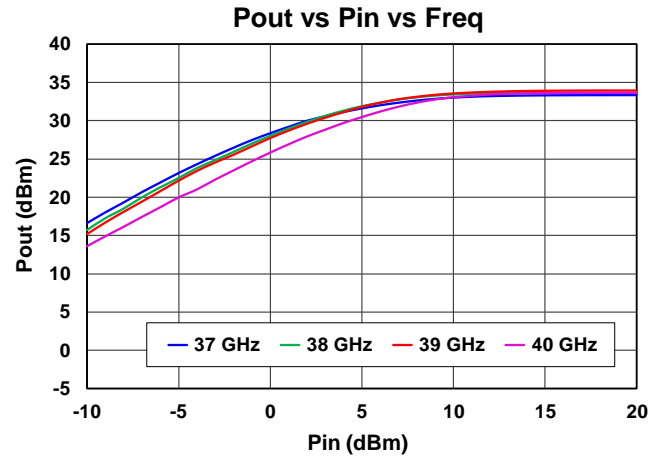
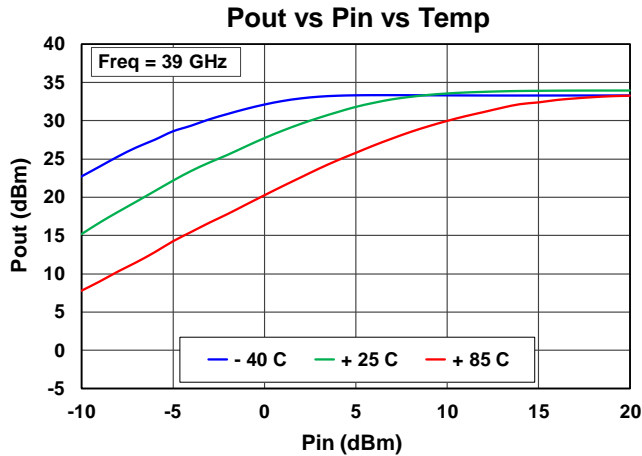

### Performance Plots, Linearity, Transmit Path

Test Conditions unless otherwise stated: TXVD = 20 V, TXIDQ12 = 135 mA, TXIDQ3 = 24 mA, Tone Spacing = 10 MHz, 25 C

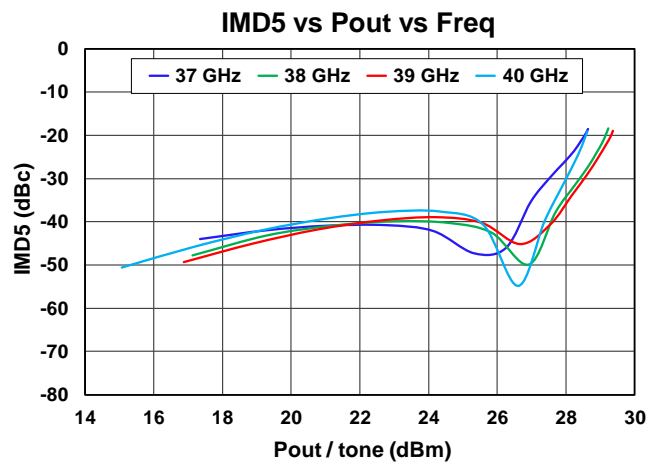
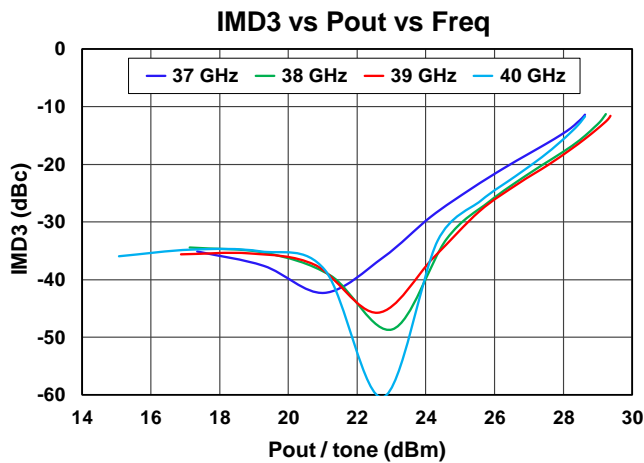
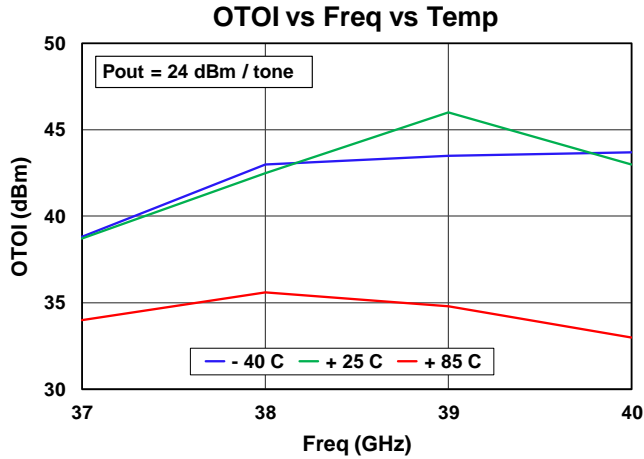

## Performance Plots, Modulated Signal, Transmit Path

Test Conditions unless otherwise stated: TXVD = 20 V, 25 C  
TXIDQ12 = 135 mA, TXIDQ3 = 24 mA (159mA), for other bias conditions refer to Nominal Operating Condition table in page 2

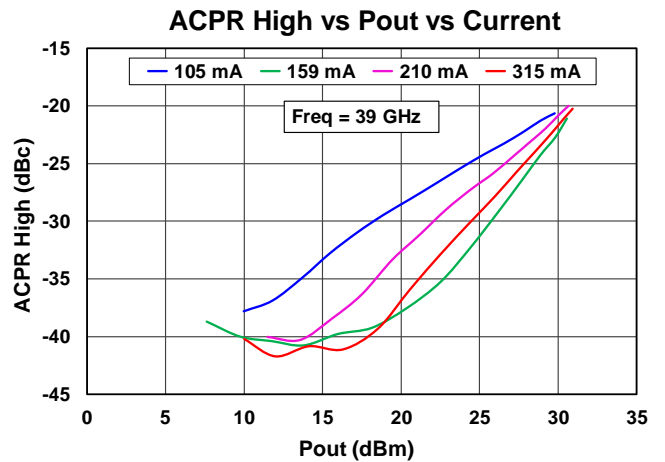
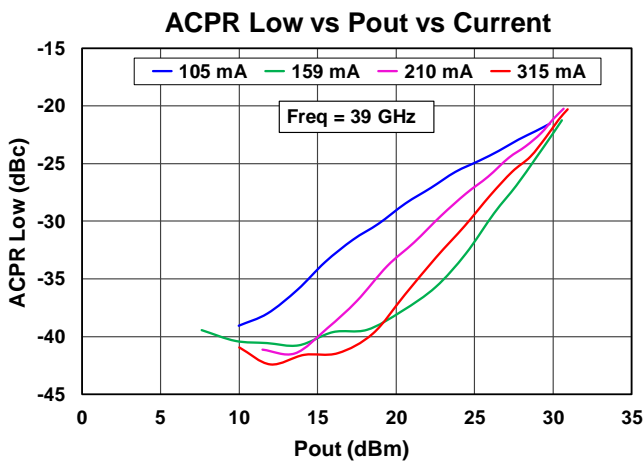
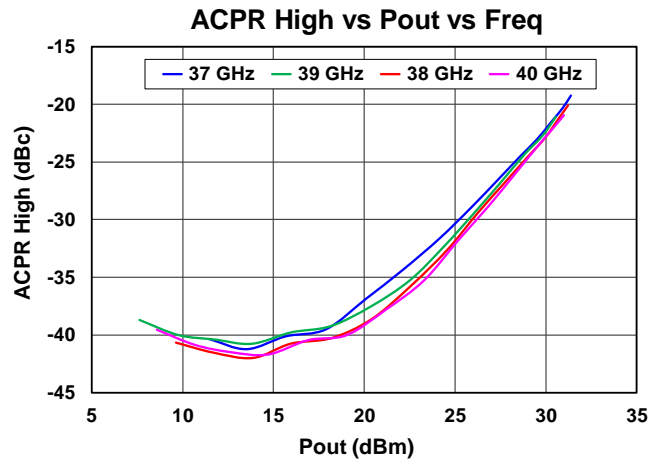
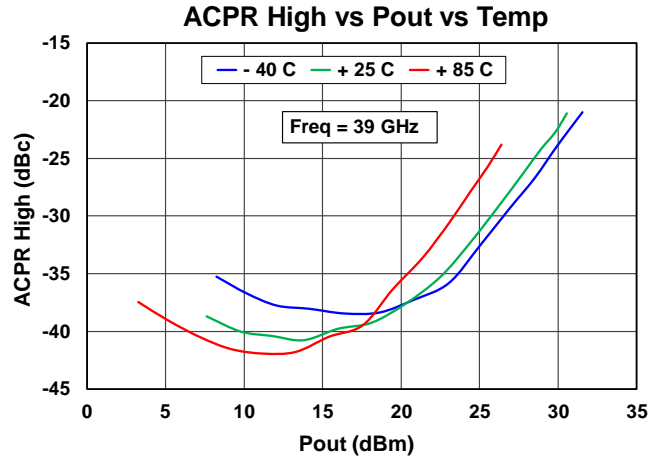

### Performance Plots, Modulated Signal, Transmit Path

Test Conditions unless otherwise stated: TXVD = 20 V, TXIDQ12 = 135 mA, TXIDQ3 = 24 mA  
Source: 400 MHz OFDM, 64 QAM, 25 C

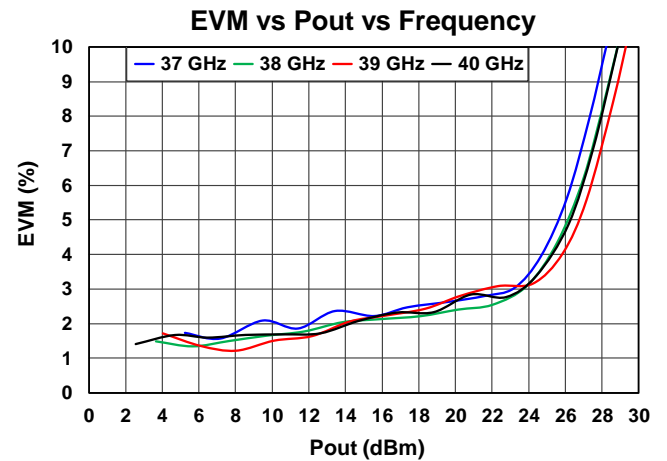
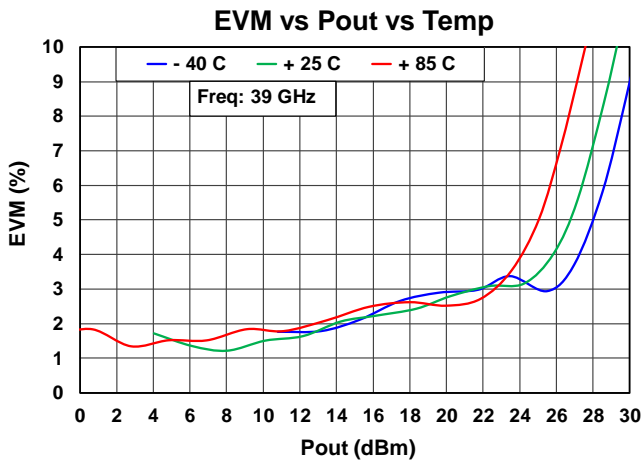
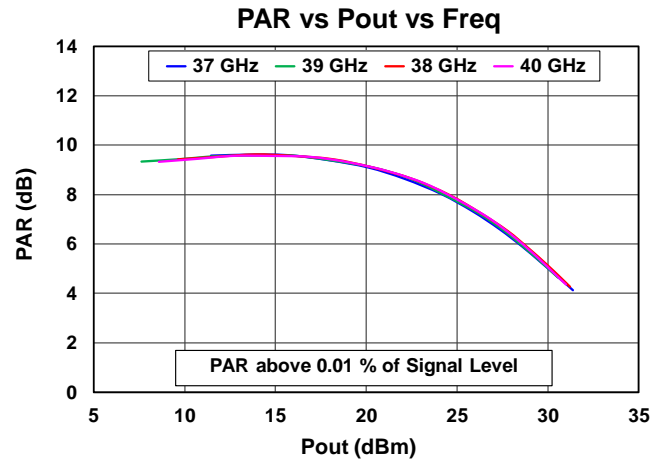
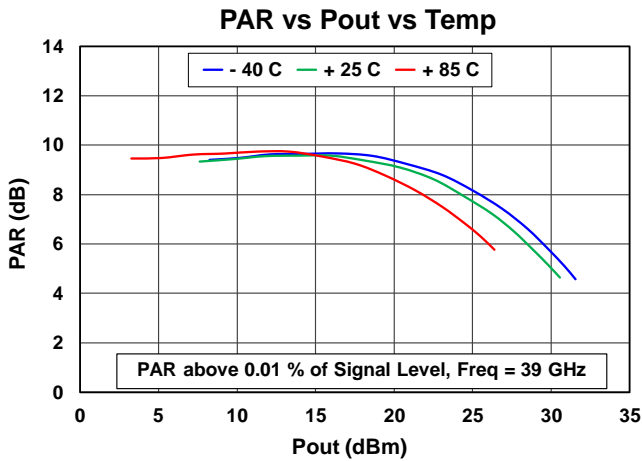

### Performance Plots, Modulated Signal, Transmit Path

Test Conditions unless otherwise stated: TXVD = 20 V, TXIDQ12 = 135 mA, TXIDQ3 = 24 mA  
 Source: 400 MHz OFDM, 64 QAM, 25 C

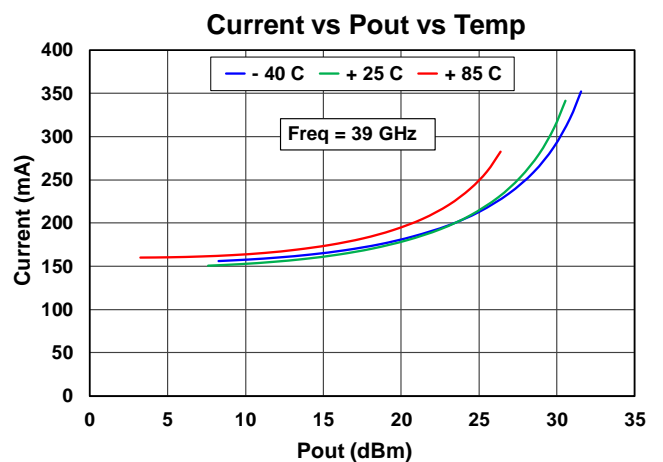
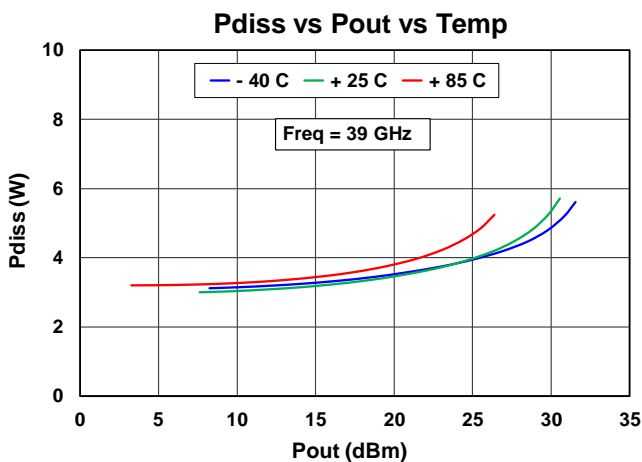
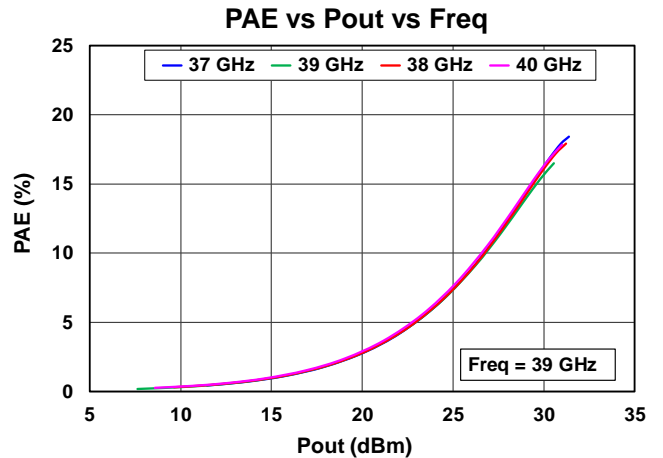
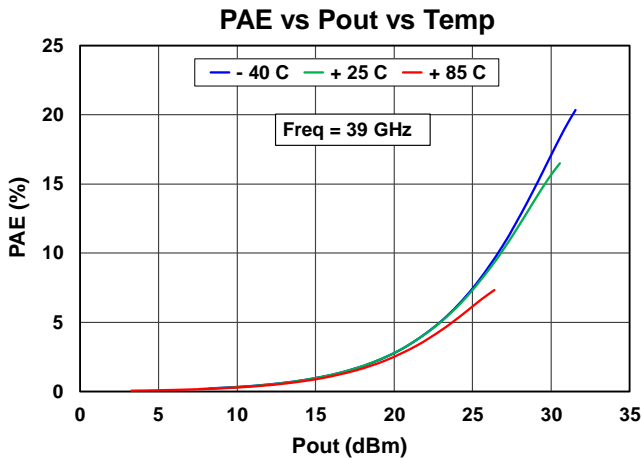
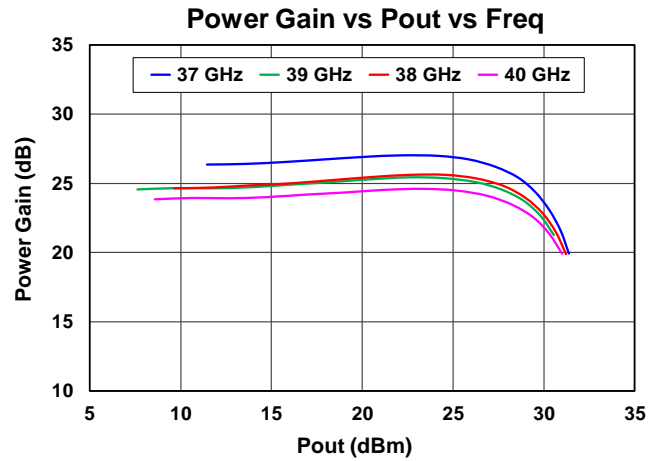
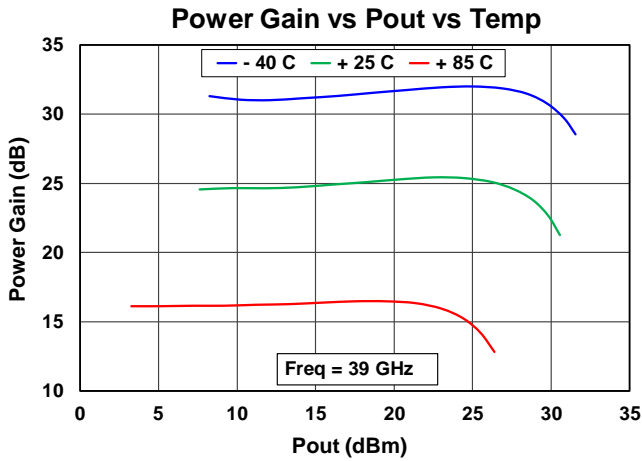

Performance Plots, Channel Isolations

Test Conditions unless otherwise stated: TXVD = 20 V, TXIDQ12 = 135 mA, TXIDQ3 = 24 mA, RXVD = 20 V, RXID = 15 mA  
Cable calibration, data not de-embedded, 25 C

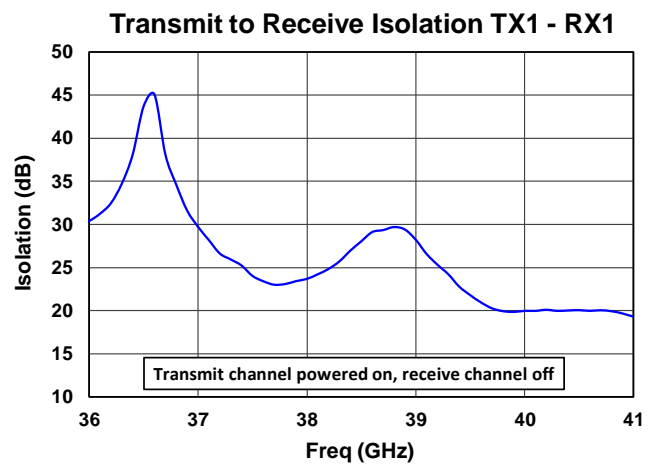
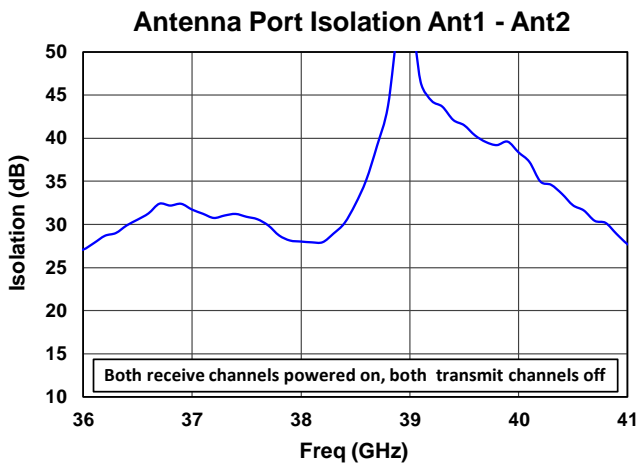
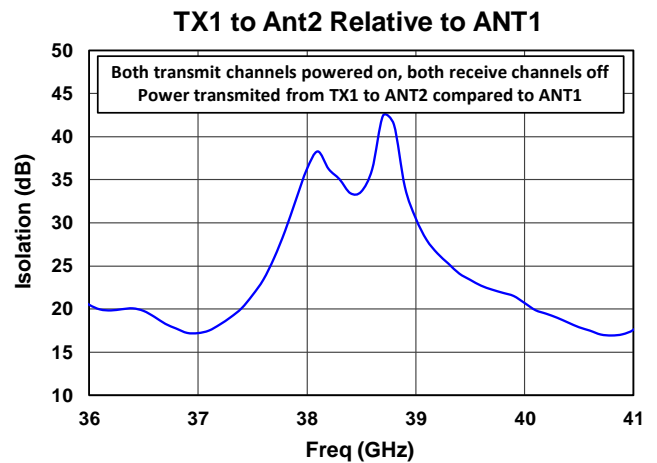
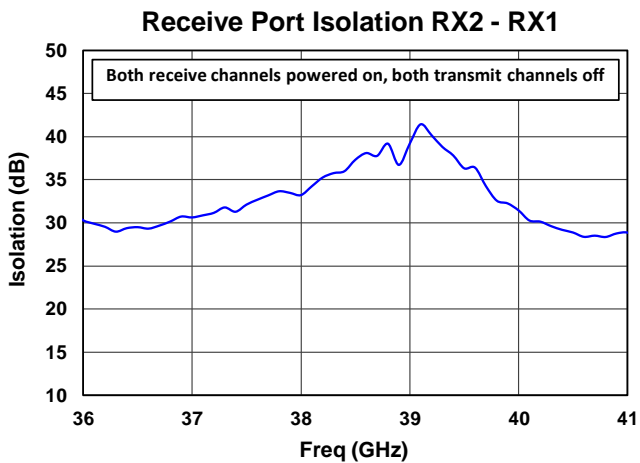
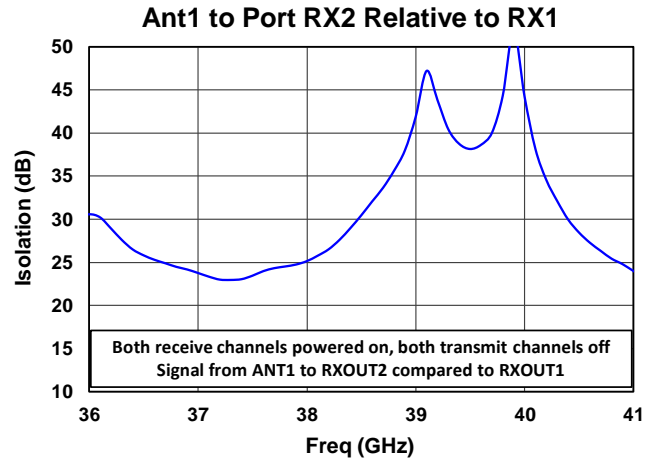
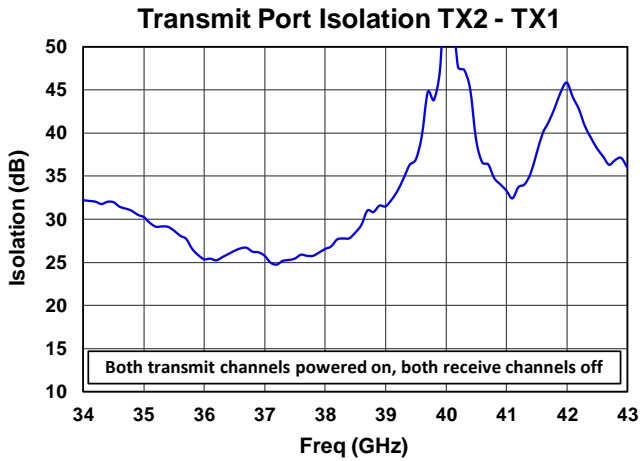



### Mechanical Drawings & Pad Descriptions

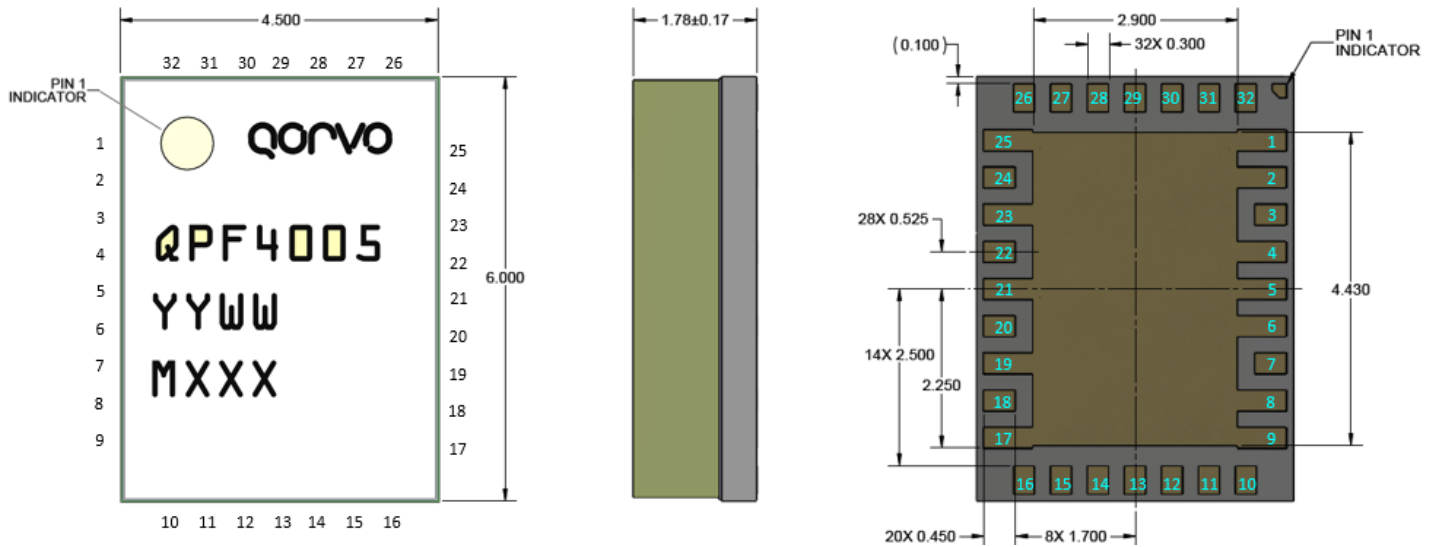

Dimensions in mm

Part Marking: QPF4005: Part Number, YY = Part Assembly Year, WW = Part Assembly Week, MXXX = Batch ID

Pin Number	Label	Description
1, 2, 4, 5, 6, 8, 9	GND	GROUND
3	ANT_1	Channel 1 Antenna
22	RXOUT_1	Channel 1 Receive Output
24	TXIN_1	Channel 1 Transmit Input
26	RXVG_1	Channel 1 Receive VG
27	RXVD_1	Channel 1 Receive VD
28	TXVG12_1	Channel 1 Transmit VG12
29	TXVG3_1	Channel 1 Transmit VG3
30	TXVD_1	Channel 1 Transmit VD
31	TXSW_1	Channel 1 Transmit Switch
32	RXSW_1	Channel 1 Receive Switch
7	ANT_2	Channel 2 Antenna
10	RXSW_2	Channel 2 Receive Switch
11	TXSW_2	Channel 2 Transmit Switch
12	TXVD_2	Channel 2 Transmit VD
13	TXVG3_2	Channel 2 Transmit VG3
14	TXVG12_2	Channel 2 Transmit VG12
15	RXVD_2	Channel 2 Receive VD
16	RXVG_2	Channel 2 Receive VG
18	RXOUT_2	Channel 2 Receive Output
20	TXIN_2	Channel 2 Transmit Input
17, 19, 21, 23, 25, Slug	GND	GROUND

Evaluation Board and Assembly

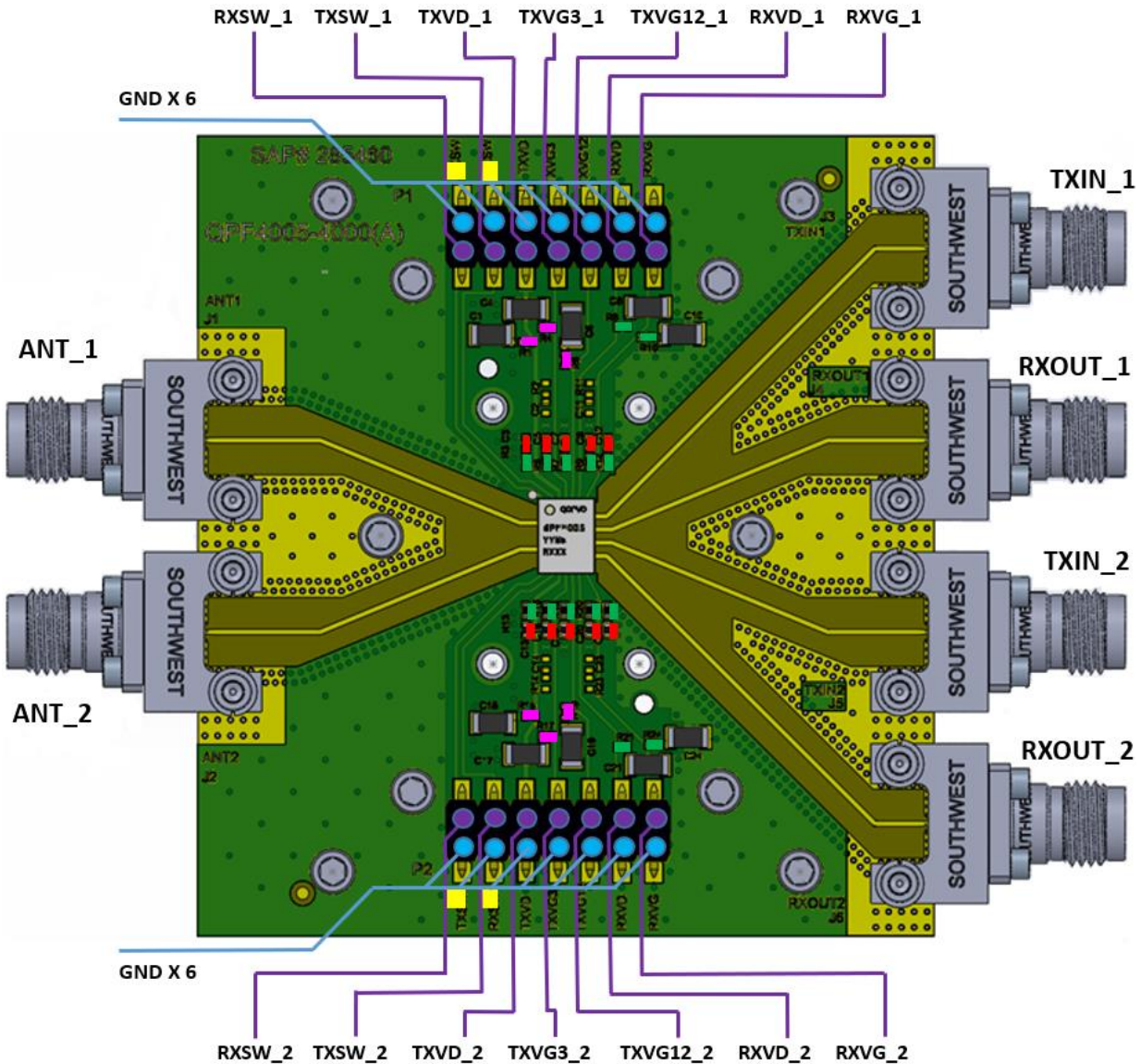

RF Layer is 0.008" thick Rogers Corp. RO4003C ( $\epsilon_r = 3.35$ ). Metal layers are 0.5 oz. copper. The microstrip line at the connector interface is optimized for the Southwest Microwave end launch connector 1492-04A-5.

Ref. Des.	Component	Value	Manuf.	Remark
C2, C4, C6, C8, C10	SMT Cap.	CAP, 0402 1000pF +/-10% 50V 0402 X7R ROHS	Various	Red
C1, C3, C5, C7, C9	SMT Cap.	CAP, 1206 1.0uF +/-10% 50V X7R ROHS	Various	Grey
R2, R4, R6 - R10	SMT Res.	RES, 0402 5.1 OHM, 5% 50V, ROHS	Various	Green
R1, R3, R5	SMT Res.	RES, 0402 0 OHM, 5%, ROHS	Various	Pink

### Application Circuit



### Bias-up Procedure

1. Set drain supply TXVD limit to 700 mA, RXVD limit to 50 mA, gate and control supply limit to 10 mA each.
2. Set TXVG12, TXVG3, RXVG to -5 V
3. Set TXSW = 20 V (or 0 V), RXSW = 0 V (or 20 V)
4. Set VD = +20 V
5. For TX, adjust TXVG12 to get TXID12 current, then adjust TXVG3 to achieve required total drain current; For RX, adjust RXVG to achieve required drain current.
6. Apply RF signal

### Bias-down Procedure

1. Turn off RF signal
2. Set TXVG12, TXVG3 and RXVG to -5 V
3. Set VD = 0 V
4. Turn off drain supply
5. Turn off TXSW, RXSW
6. Turn off gate supply

## Absolute Maximum Ratings

Parameter	Value
Drain Voltage (TXVD, RXVD)	28 V
Drain Current (TXID3+TXID12)	800 mA
Drain Current (RXID)	60 mA
Gate Voltage (RXVG, TXVG3, TXVG12)	0 to -5 V
Gate Current (RXIG, TXIG3, TXIG12)	20 mA
Switch Control Voltage (TXSW, RXSW)	0 to 28 V
Switch Control Current	20 mA
RF Input Power (All RF ports, 85 °C)	30 dBm
Channel Temperature, T <sub>CH</sub>	225 °C
Mounting Temperature (30 seconds)	260 °C
Storage Temperature	-55 to 150 °C

Operation of this device outside the parameter ranges given above may cause permanent damage. These are stress ratings only, and functional operation of the device at these conditions is not implied. Extended application of Absolute Maximum Rating conditions to the device may reduce device reliability.

## Thermal and Reliability Information

Parameter	Values	Units	Conditions
Thermal Resistance ( $\theta_{JC}$ ) <sup>(1,2,3)</sup> , Quiescent, TX	14.9	°C/W	TX on, RX off, CW, V <sub>D</sub> = +20 V, I <sub>DQ</sub> = 159 mA, T <sub>BASE</sub> = 85 °C RF off, P <sub>DISS</sub> = 3.18 W
Channel Temperature (T <sub>CH</sub> ), Quiescent, TX	132.4	°C	
Thermal Resistance ( $\theta_{JC}$ ) <sup>(1,2,3)</sup> , Under Drive, TX	10.7	°C/W	TX on, RX off, CW, V <sub>D</sub> = +20 V, T <sub>BASE</sub> = 85 °C, Freq = 39 GHz, P <sub>IN</sub> = 10 dBm, P <sub>OUT</sub> = 25 dBm, I <sub>D_DRIVE</sub> = 0.25 A, P <sub>DISS</sub> = 4.69 W
Channel Temperature (T <sub>CH</sub> ), Under Drive, TX	135.2	°C	
Thermal Resistance ( $\theta_{JC}$ ) <sup>(1,2,3)</sup> , Quiescent, RX	67.0	°C/W	RX on, TX off, CW, V <sub>D</sub> = +20 V, I <sub>DQ</sub> = 15 mA T <sub>BASE</sub> = 85 °C RF off, P <sub>DISS</sub> = 0.3 W
Channel Temperature (T <sub>CH</sub> ), Quiescent, RX	105.1	°C	

Notes:

1. Thermal resistance is referenced to package backside
2. Base or ambient temperature is 85 °C
3. Refer to the following document: [GaN Device Channel Temperature, Thermal Resistance, and Reliability Estimates](#)

## Solderability

1. Compatible with the latest version of J-STD-020, Lead-free solder, 260 °C.
2. This package is non-hermetic, and therefore cannot be subjected to aqueous washing. The use of no-clean solder to avoid washing is highly recommended.

## Recommended Soldering Temperature Profile

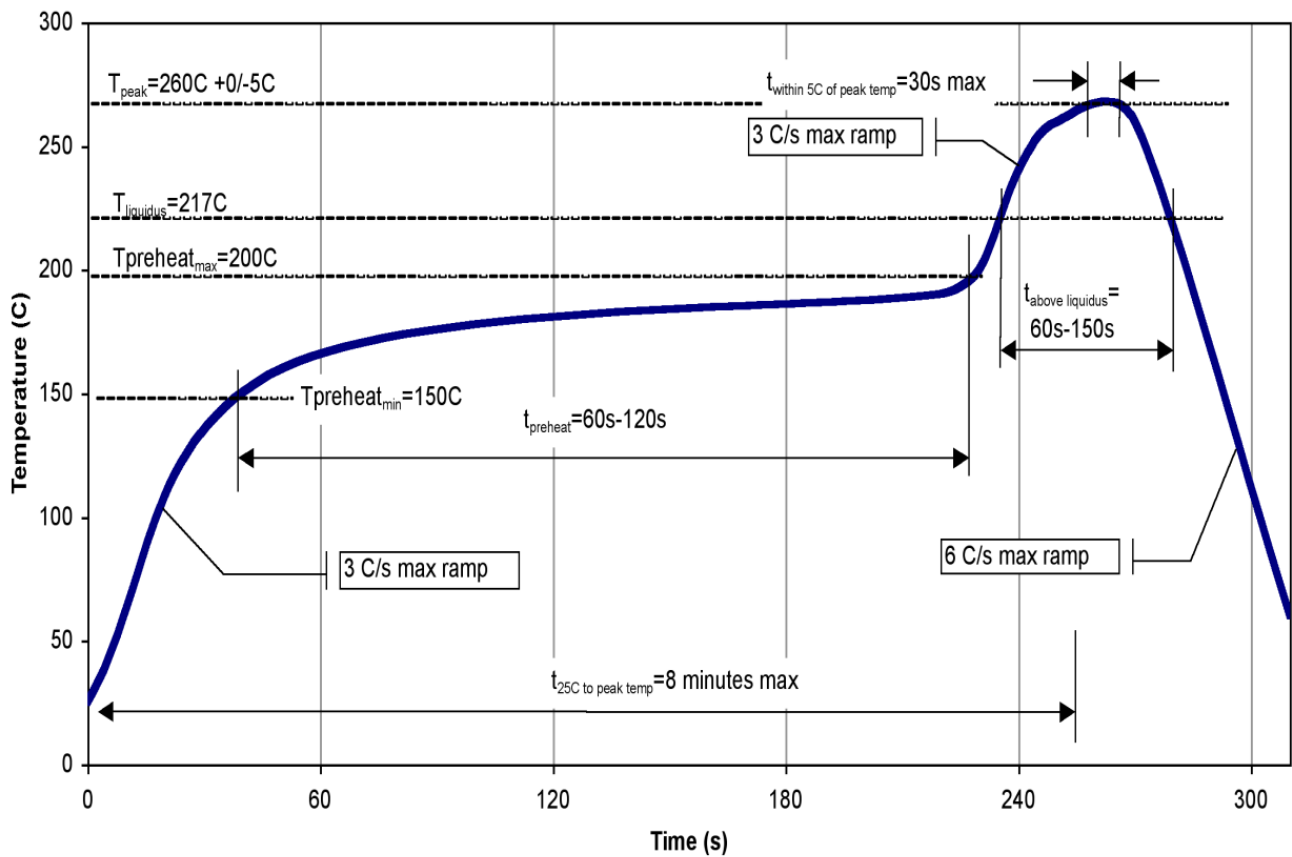

## Handling Precautions

Parameter	Rating	Standard
ESD – Human Body Model (HBM)	0B	ESDA / JEDEC JS-001-2012
ESD – Charged Device Model (CDM)	C1	ESDA / JEDEC JS-002-2014
MSL – Convection Reflow 260 °C	5A	JEDEC standard IPC/JEDEC J-STD-020



Caution!  
ESD-Sensitive Device

## RoHS Compliance

This product is compliant with the 2011/65/EU RoHS directive (Restrictions on the Use of Certain Hazardous Substances in Electrical and Electronic Equipment), as amended by Directive 2015/863/EU. This product also has the following attributes:

- Lead Free
- Antimony Free
- TBBP-A (C<sub>15</sub>H<sub>12</sub>Br<sub>4</sub>O<sub>2</sub>) Free

## Contact Information

For the latest specifications, additional product information, worldwide sales and distribution locations:

**Tel:** 1-844-890-8163

**Web:** [www.qorvo.com](http://www.qorvo.com)

**Email:** [customer.support@qorvo.com](mailto:customer.support@qorvo.com)

## Important Notice

The information contained herein is believed to be reliable; however, Qorvo makes no warranties regarding the information contained herein and assumes no responsibility or liability whatsoever for the use of the information contained herein. All information contained herein is subject to change without notice. Customers should obtain and verify the latest relevant information before placing orders for Qorvo products. The information contained herein or any use of such information does not grant, explicitly or implicitly, to any party any patent rights, licenses, or any other intellectual property rights, whether with regard to such information itself or anything described by such information. **THIS INFORMATION DOES NOT CONSTITUTE A WARRANTY WITH RESPECT TO THE PRODUCTS DESCRIBED HEREIN, AND QORVO HEREBY DISCLAIMS ANY AND ALL WARRANTIES WITH RESPECT TO SUCH PRODUCTS WHETHER EXPRESS OR IMPLIED BY LAW, COURSE OF DEALING, COURSE OF PERFORMANCE, USAGE OF TRADE OR OTHERWISE, INCLUDING THE IMPLIED WARRANTIES OF MERCHANTABILITY AND FITNESS FOR A PARTICULAR PURPOSE.**

Without limiting the generality of the foregoing, Qorvo products are not warranted or authorized for use as critical components in medical, life-saving, or life-sustaining applications, or other applications where a failure would reasonably be expected to cause severe personal injury or death.

Copyright 2020 © Qorvo, Inc. | Qorvo is a registered trademark of Qorvo, Inc.

Компания «Life Electronics» занимается поставками электронных компонентов импортного и отечественного производства от производителей и со складов крупных дистрибьюторов Европы, Америки и Азии.

С конца 2013 года компания активно расширяет линейку поставок компонентов по направлению коаксиальный кабель, кварцевые генераторы и конденсаторы (керамические, пленочные, электролитические), за счёт заключения дистрибьюторских договоров

Мы предлагаем:

- Конкурентоспособные цены и скидки постоянным клиентам.
- Специальные условия для постоянных клиентов.
- Подбор аналогов.
- Поставку компонентов в любых объемах, удовлетворяющих вашим потребностям.
- Приемлемые сроки поставки, возможна ускоренная поставка.
- Доставку товара в любую точку России и стран СНГ.
- Комплексную поставку.
- Работу по проектам и поставку образцов.
- Формирование склада под заказчика.
- Сертификаты соответствия на поставляемую продукцию (по желанию клиента).
- Тестирование поставляемой продукции.
- Поставку компонентов, требующих военную и космическую приемку.
- Входной контроль качества.
- Наличие сертификата ISO.

В составе нашей компании организован Конструкторский отдел, призванный помогать разработчикам, и инженерам.

Конструкторский отдел помогает осуществить:

- Регистрацию проекта у производителя компонентов.
- Техническую поддержку проекта.
- Защиту от снятия компонента с производства.
- Оценку стоимости проекта по компонентам.
- Изготовление тестовой платы монтаж и пусконаладочные работы.



Тел: +7 (812) 336 43 04 (многоканальный)

Email: [org@lifeelectronics.ru](mailto:org@lifeelectronics.ru)