



4D SYSTEMS
TURNING TECHNOLOGY INTO ART

2.83" AMOLED Display Module **μOLED-32028-P1(T)**

P1 = Non-Touch Version

P1T = Resistive Touch Version

Document Date: 8th November 2013
Document Revision: 1.2

Contents

1. Description	3
2. Features	3
3. Pin Configuration and Summary	4
4. Hardware Interface - Pins	7
4.1. Serial Ports - COM0, COM1 UARTS	7
4.2. General Purpose I/O.....	7
4.3. System Pins	8
5. PmmC/Firmware Programming	8
6. Module Features	9
6.1. Display – 2.8" AMOLED Touch Screen.....	9
6.2. PICASO Processor	9
6.3. Audio	9
6.4. SD/SDHC Memory Cards	9
6.5. FAT16	9
7. Display Precautions	10
8. Hardware Tools	11
8.1. 4D Programming Cable / Adaptor	11
9. 4DGL - Software Language	11
10. 4D Systems - Workshop 4 IDE	12
10.1. Workshop 4 – Designer Environment	12
10.2. Workshop 4 – ViSi Environment.....	12
10.3. Workshop 4 – ViSi Genie Environment	13
10.4. Workshop 4 – Serial Environment.....	13
11. Starter Kit	14
12. Notes	15
13. Mechanical Details	16
14. Schematic Diagram	17
15. Specifications and Ratings	20
16. Legal Notice	22
17. Contact Information	22

1. Description

The μOLED-32028-P1(T) is a compact and cost effective all in one Intelligent Display Module using Active Matrix OLED (AMOLED) technology with an embedded PICASO graphics controller that delivers 'stand-alone' functionality to any project.

The 2.83" AMOLED display is a very high quality, high viewing angle, crisp and clean viewing display that is suited to a large range of applications.

The PICASO belongs to a family of processors powered by a highly optimised soft core virtual engine, E.V.E. (Extensible Virtual Engine). EVE is a proprietary, high performance virtual processor with an extensive byte-code instruction set optimised to execute compiled 4DGL programs. 4DGL (4D Graphics Language) was specifically developed from ground up for the EVE engine core. It is a high level language which is easy to learn and simple to understand yet powerful enough to tackle many embedded graphics applications.

4DGL allows the developer to write applications in a high level syntax similar to popular languages such as BASIC, C and Pascal and run it directly on the PICASO processor embedded in the μOLED-32028-P1(T) module.

It allows the user to take complete control of all available resources on that hardware platform such as the Serial Port, Graphics AMOLED Display, uSD memory card, I/O pins, etc. This eliminates the need for an external host controller/processor to drive the μOLED-32028-P1(T) module via serial commands. It provides the user complete control over the hardware module allowing them to quickly develop powerful applications.

Please Note: The μOLED-32028-P1(T) module is not recommended for new designs, and should only be used where continued supply is not required. The AMOLED displays are available only as a limited run and therefore once stocks deplete, we may be unable to source any more. Please make contact with the 4D Systems Sales team to find out more information.



2. Features

- Low-cost OLED display graphics user interface solution.
- 240 x 320 QVGA resolution, 65K true to life colours, AMOLED screen.
- Screen Size: 2.83", 49.1mm x 67.3mm
- Viewing Area: 42.3mm x 57.6mm
- Resistive Touch Screen (μOLED-32028-P1T)
- No Touch Screen (μOLED-32028-P1)
- The controller boards have mechanical support via mounting tabs which can be snapped off.
- Board Size: 49.1 x 67.3 x 11.0mm (not including 3 x mounting tabs with 3mm holes for mechanical support).
- No back lighting with near 180° viewing angle.
- Integrated 4-Wire resistive Touch Panel.
- Easy 5 pin interface to any host device:
VCC, TX, RX, GND, RESET
- Powered by the 4D-Labs PICASO processor
- 14KB of flash memory for user code storage and 14KB of SRAM for user variables, or 14KB shared user code and program variables.
- 2 x Asynchronous hardware serial ports (COM0, COM1), TTL interface, with 300 baud to 600K baud.
- 1 x I2C interface (Master).
- 8 x 16 bit timers with 1 millisecond resolution.
- 13 x GPIO pins. Upper 8 bits can be used as an I/O Bus for fast 8-bit parallel data transfers.
- On-board micro-SD memory card adaptor for multimedia storage and data logging purposes. HC memory card support is also available for cards larger than 4Gb.
- DOS compatible file access (FAT16 format) as well as low level access to card memory.
- Dedicated PWM Audio pin supports FAT16 audio WAV files and complex sound generation.
- On-board audio amplifier with a tiny 8 Ohms speaker for sound generation and WAV file playback.
- Built in extensive 4DGL graphics and system library functions. For all available features and functions under the 4DGL programming language.
- Display full colour images, animations, icons and video clips.
- Supports all available Windows fonts and characters.
- 2 x 30 pin headers for I/O expansion.
- 4.0V to 5.5V range operation (single supply).
- RoHS Compliant.

3. Pin Configuration and Summary

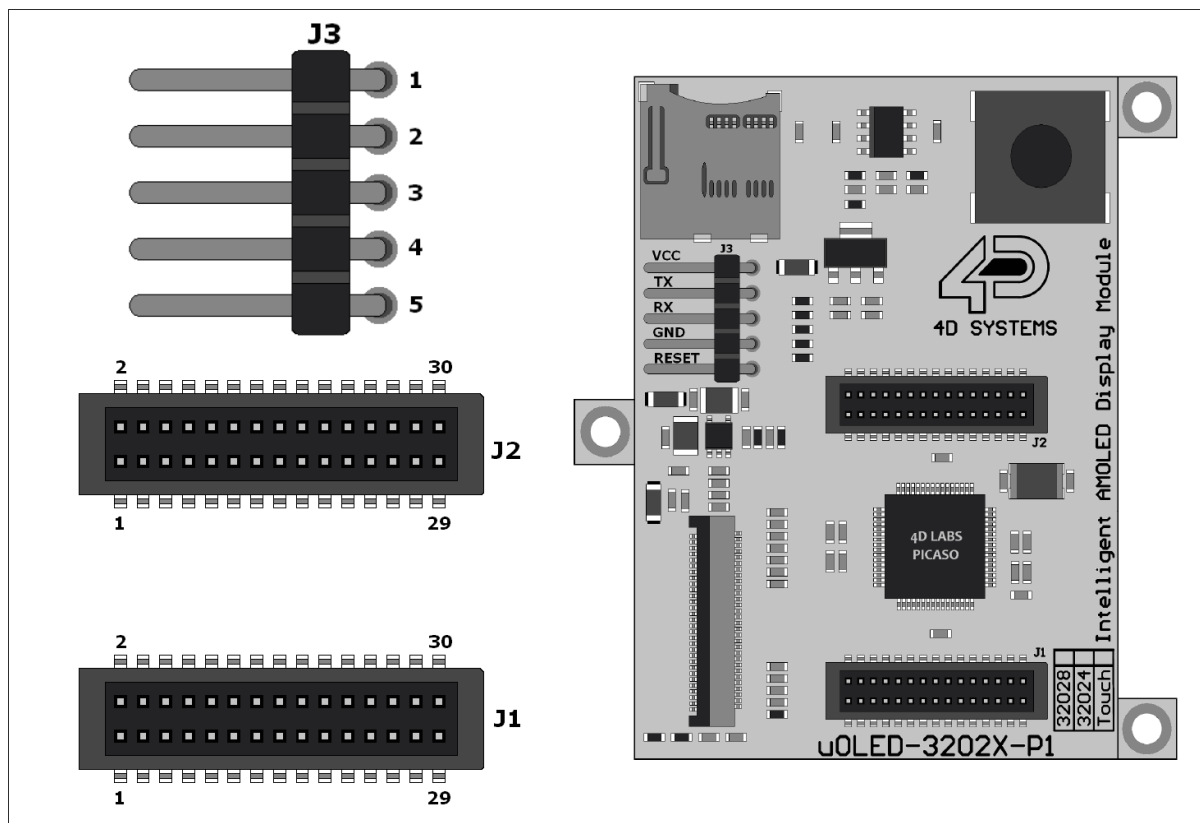

J3 Pin Outs (Programming Header)

Pin	Symbol	I/O	Description
1	VCC	P	Main Voltage Supply +ve input pin. Reverse polarity protected. Range is 4.0V to 5.5V, nominal 5.0V.
2	TX	O	Asynchronous Serial Transmit pin, TTL level. Connect this pin to the Receive (Rx) signal of other serial devices. Used in conjunction with the RX pin for programming this microLCD. This pin is tolerant up to 5.0V levels.
3	RX	I	Asynchronous Serial Receive pin, TTL level. Connect this pin to the Transmit (Tx) signal of other serial devices. Used in conjunction with the TX pin for programming this microLCD. This pin is tolerant up to 5.0V levels.
4	GND	P	Supply Ground
5	RES	I	Master Reset signal. Internally pulled up to 3.3V via a 10K resistor. An active Low pulse greater than 2 micro-seconds will reset the module. If the module needs to be reset externally, only use open collector type circuits. This pin is not driven low by any internal conditions. The host should control this pin via one of its port pins using an open collector/drain arrangement.

I = Input, O = Output, P = Power

Continued next page

J1 Pin Outs (I/O Expansion Header)			
Pin	Symbol	I/O	Description
1	IO2	I/O	General Purpose Input Output 2 Pin
2	IO1	I/O	General Purpose Input Output 1 Pin
3	IO3	I/O	General Purpose Input Output 3 Pin
4	N/C	-	Not Used
5	IO4/BUS_RD	I/O	General Purpose Input Output 4 Pin or Bus Read
6	N/C	-	Not Used
7	N/C	-	Not Used
8	N/C	-	Not Used
9	N/C	-	Not Used
10	N/C	-	Not Used
11	N/C	-	Not Used
12	N/C	-	Not Used
13	N/C	-	Not Used
14	RESET	I	Master RESET. Pull this pin Low for 20µsec or longer to Reset the module.
15	GND	P	Supply Ground
16	N/C	-	Not Used
17	BUS5	I/O	IO Bus (BUS0..7) bit 5
18	3.3V	P	Regulated 3.3V Output
19	BUS4	I/O	IO Bus (BUS0..7) bit 4
20	N/C	-	Not Used
21	BUS3	I/O	IO Bus (BUS0..7) bit 3
22	N/C	-	Not Used
23	BUS2	I/O	IO Bus (BUS0..7) bit 2
24	N/C	-	Not Used
25	BUS1	I/O	IO Bus (BUS0..7) bit 1
26	N/C	-	Not Used
27	BUS0	I/O	IO Bus (BUS0..7) bit 0
28	N/C	-	Not Used
29	N/C	-	Not Used
30	N/C	-	Not Used

I = Input, O = Output, P = Power

Continued next page

J2 Pin Outs (I/O Expansion Header)			
Pin	Symbol	I/O	Description
1	N/C	-	Not Used
2	N/C	-	Not Used
3	N/C	-	Not Used
4	N/C	-	Not Used
5	N/C	-	Not Used
6	VCC	P	Main Voltage Supply +ve input pin 4.5Volts to 5.5Volts. Nominal @ 5Volts
7	N/C	-	Not Used
8	N/C	-	Not Used
9	IO5/BUS_WR	I/O	General Purpose Input Output 5 pin or Bus Write
10	N/C	-	Not Used
11	BUS7	I/O	IO Bus (BUS0..7) bit 7
12	N/C	-	Not Used
13	BUS6	I/O	IO Bus (BUS0..7) bit 6
14	N/C	-	Not Used
15	GND	P	Supply Ground
16	3.3V	P	Regulated 3.3V Output
17	GND	P	Supply Ground
18	3.3V	P	Regulated 3.3V Output
19	N/C	-	Not Used
20	N/C	-	Not Used
21	SCL	O	I2C Clock Output
22	N/C	-	Not Used
23	SDA	I/O	I2C Bi-Directional Data
24	N/C	-	Not Used
25	N/C	-	Not Used
26	N/C	-	Not Used
27	RX0	I	Asynchronous serial port 0 receive pin. COM0 Rx.
28	TX1	O	Asynchronous serial port 1 receive pin. COM1 Tx.
29	TX0	O	Asynchronous serial port 0 receive pin. COM0 Tx.
30	RX1	I	Asynchronous serial port 1 receive pin. COM1 Rx.

I = Input, O = Output, P = Power

4. Hardware Interface - Pins

The µOLED-32028-P1(T) provides both a hardware and software interface. This section describes in detail the hardware interface pins of the device.

4.1. Serial Ports - COM0, COM1 UARTS

The µOLED-32028-P1(T) has two dedicated hardware Asynchronous Serial ports that can communicate with external serial devices. These are referred to as the COM0 and the COM1 serial ports.

The primary features are:

- Full-Duplex 8 bit data transmission and reception.
- Data format: 8 bits, No Parity, 1 Stop bit.
- Independent Baud rates from 300 baud up to 600K baud.
- Single byte transmits and receives or a fully buffered service. The buffered service feature runs in the background capturing and buffering serial data without the user application having to constantly poll any of the serial ports. This frees up the application to service other tasks.

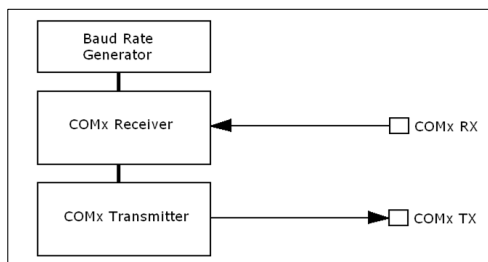

A single byte serial transmission consists of the start bit, 8-bits of data followed by the stop bit. The start bit is always 0, while a stop bit is always 1. The LSB (Least Significant Bit, Bit 0) is sent out first following the start bit. Figure below shows a single byte transmission timing diagram.

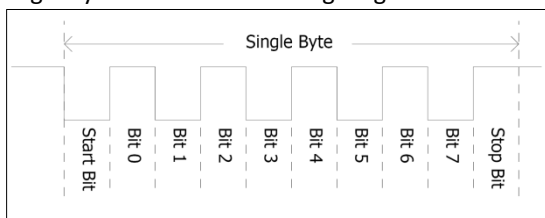

COM0 is also the primary interface for 4DGL user program downloads and chip configuration (PmmC programming). Once the compiled 4DGL application program (EVE byte-code) is downloaded and the user code starts executing, the serial port is then available to the user application. Refer to Section 5. 'Firmware / PmmC Programming' for more details on this subject.

TX0 pin (Serial Transmit COM0):

Asynchronous Serial port COM0 transmit pin, TX0. Connect this pin to external serial device receive (Rx) signal. This pin is 5.0V tolerant.

RX0 pin (Serial Receive COM0):

Asynchronous Serial port COM0 receive pin, RX0. Connect this pin to external serial device transmit (Tx) signal. This pin is 5.0V tolerant.

TX1 pin (Serial Transmit COM1):

Asynchronous Serial port COM1 transmit pin, TX1. Connect this pin to external serial device receive (Rx) signal. This pin is 5.0V tolerant.

RX1 pin (Serial Receive COM1):

Asynchronous Serial port COM1 receive pin, RX1. Connect this pin to external serial device transmit (Tx) signal. This pin is 5.0V tolerant.

4.2. General Purpose I/O

There are 13 general purpose Input/Output (GPIO) pins available to the user. These are grouped as IO1..IO5 (Note for IO1, IO2 and IO3 below) and BUS0..BUS7. Power-Up Reset default is all INPUTS.

The 5 I/O pins (IO1..IO5), provide flexibility of individual bit operations while the 8 pins (BUS0..BUS7), known as GPIO BUS, serve collectively for byte wise operations. The IO4 and IO5 also act as strobing signals to control the GPIO Bus. GPIO Bus can be read or written by strobing a low pulse (50ns duration or greater) the IO4/BUS_RD or IO5/BUS_WR for read or write respectively. For detailed usage refer to the separate document titled:

"PICASO-4DGL-Internal-Functions.pdf"

IO1-IO3 pins (3 x GPIO pins):

General purpose I/O pins. Each pin can be individually set for INPUT or an OUTPUT.

IO4/BUS_RD pin (GPIO IO4 or BUS_RD pin):

General Purpose IO4 pin. Also used for BUS_RD signal to read and latch the data in to the parallel GPIO BUS0..BUS7.

IO5/BUS_WR pin (GPIO IO5 or BUS_WR pin):

General Purpose IO5 pin. Also used for BUS_WR signal to write and latch the data to the parallel GPIO BUS0..BUS7.

BUS0-BUS7 pins (GPIO 8-Bit Bus):

8-bit parallel General purpose I/O Bus.

Note: All GPIO pins are 5.0V tolerant.

4.3. System Pins

VCC (Module Voltage Input)

J3 Pin 1, J2 Pin 6:

Module supply voltage input pin. This pin must be connected to a regulated supply voltage in the range of 4.0 Volts to 5.5 Volts DC. Nominal operating voltage is 5.0 Volts.

3.3V Out (3.3V Regulated Output)

J1 Pin 18, J2 Pin 16/18:

External circuitry that requires a regulated 3.3V supply can be powered up via this pin. Maximum available current is 400mA.

GND (Module Ground)

J3 Pin 4, J2 Pin 15/17:

Device ground pins. These pins must be connected to ground.

RESET (Module Master Reset)

J3 Pin 5, J1 Pin 14:

Module Master Reset pin. An active low pulse of greater than 2µs will reset the module. Internally pulled up to 3.3V via a 10K resistor. Only use open collector type circuits to reset the device if an external reset is required.

5. PmmC/Firmware Programming

The PICASO processor used in the µOLED-32028-P1(T) module is a custom graphics processor. All functionality including the high level commands are built into the chip. This chip level configuration is available as a Firmware/PmmC (Personality-module-micro-Code) file.

A PmmC file contains all of the low level micro-code information (analogy of that of a soft silicon) which define the characteristics and functionality of the device. The ability of programming the device with a PmmC file provides an extremely flexible method of customising as well as upgrading it with future enhancements.

A PmmC file can only be programmed into the device via its COM0 serial port. Figure below provides a typical implementation for the PmmC programming interface.

The PmmC file is programmed into the device with the aid of Workshop 4, the 4D Systems IDE software (See Section 11). To provide a link between the PC and the ICSP interface, a specific 4D Programming Cable is required and is available from 4D Systems.

Using a non-4D programming interface could damage your display, and **void your Warranty**.

Please refer to section 8.1 for more information on 4D programming interfaces.

6. Module Features

The µOLED-32028-P1(T) module is designed to accommodate most applications. Some of the main features of the module are listed below.

6.1. Display – 2.8” AMOLED Touch Screen

The µOLED-32028-P1(T) module is equipped with a 2.83” AMOLED display. Details of the display are listed below:

- Screen Size: 2.83” diagonal
- Resolution: 240 x 320
- Integrated 4-Wire Resistive Touch Screen
- Screen Dimensions: 49.1 x 67.3 mm
- Viewing Area: 42.3 x 57.6mm
- Viewing Angles: 160 degrees

Note: The Displays used are the highest rated ‘Grade A’ Displays, which allow for 0-4 defective pixels. A defective pixel could be solid Black (Dead), White, Red, Green or Blue.

6.2. PICASO Processor

The module is designed around the PICASO Graphics Controller from 4D-Labs.



The PICASO is a smart Controller and the interface to the TFT- LCD displays is almost plug-n-play.

All of the data and control signals are provided by the chip to interface directly to the display.

Powerful graphics, text, image, animation and countless more features are built right inside the chip.

The data sheet for the processor is available from the <http://www.4dsystems.com.au> website:

“PICASO-Processor-Datasheet-REVx.pdf”

6.3. Audio

Audio playback support in the PICASO Processor enables the µOLED-32028-P1(T) module to play audio WAV files stored in the micro-SD memory card. PWM and an on-board audio amplifier with 8Ω speaker ensure ample audio output capability. A simple instruction enables the user to play/pause/stop audio files while continuing the execution of the user application code, such as display updates, touch recognition, communications, etc. The audio system also allows real time pitch change of audio samples.

For a complete list of audio commands please refer to the separate document titled:

“PICASO-4DGL-Internal-Functions.pdf”

Note: The on-board speaker is a small device designed to project into an audio cavity. It is not very loud by itself. To enable louder audio, it is recommended to use a larger external 8Ω speaker. See the ‘Hardware Interface Pins’ – ‘System Pins’ section for more information.

6.4. SD/SDHC Memory Cards

The module supports micro-SD memory cards via the on-board micro-SD connector. The memory card is used for all multimedia file retrieval such as images, animations and movie clips. The memory card can also be used as general purpose storage for data logging applications. Support is available for off the shelf micro-SD and high capacity HC memory cards (4GB and above).



6.5. FAT16

The µOLED-32028-P1(T) uses off the shelf standard SDHC/SD/micro-SD memory cards with up to 2GB capacity usable with FAT16 formatting. For any FAT file related operations, before the memory card can be used it must first be formatted with FAT16 option. The formatting of the card can be done on any PC system with a card reader. Select the appropriate drive and choose the FAT16 (or just FAT in some systems) option when formatting. The card is now ready to be used in the PICASO based application.

The µOLED-32028-P1(T) also supports high capacity HC memory cards (4GB and above). The

available capacity of SD-HC cards varies according to the way the card is partitioned and the commands used to access it.

The FAT partition is always first (if it exists) and can be up to the maximum size permitted by FAT16. Windows 7 will format FAT16 up to 4GB. Windows XP will format FAT16 up to 2GB and the Windows XP command prompt will format FAT16 up to 4GB.

Note: A SPI Compatible SDHC/SD/micro-SD card MUST be used. Picaso along with other 4D Systems Processors require SPI mode to communicate with the SD card. If a non-SPI compatible SD card is used then the processor will simply not be able to mount the card.

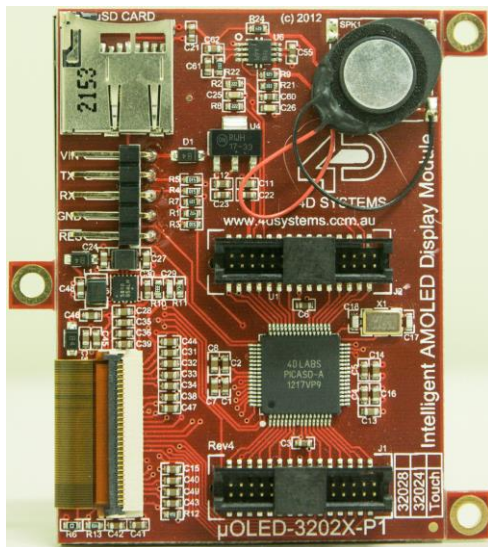

7. Display Precautions

- Avoid having to display the same image/object on the screen for lengthy periods of time. This will cause a burn-in which is a common problem with all types of display technologies. Blank the screen after a while or dim it very low by adjusting the contrast. Better still; implement a screen saver feature.
- Moisture and water can damage the display. Moisture on the surface of a powered display will cause the electrodes to corrode. Wipe off any moisture gently or let the display dry before usage.
- Dirt from fingerprint oil and fat can easily stain the surface of the display. Gently wipe off any stains with a soft lint-free cloth.
- The performance of the display will degrade under high temperature and humidity. Avoid such conditions when storing.
- Do not tamper with the display flex cable that is connected to the control board. This may affect the connection between the display and the driving circuitry and cause failure.
- Displays are susceptible to mechanical shock and any force exerted on the module may result in deformed zebra stripes, a cracked display cell and broken backlight
- Always use the mounting holes on the module's corner plates to mount the display.
- Avoid displaying objects or text on White Backgrounds. The more pixels that are lit up, the more the display module will consume current. A full white screen will have the highest power consumption. Instead try a shaded mixed colour as the background or better still a black background. Ideally have mixed coloured objects/text/icons on a black background.

8. Hardware Tools

The following hardware tools are required for full control of the μOLED-32028-P1(T) module.

8.1. 4D Programming Cable / Adaptor

The 4D Programming Cable or uUSB-PA5 Programming Adaptor are essential hardware tools to program, customise and test the PICASO Processor.

Either the 4D Programming Cable or uUSB-PA5 Adaptor (or older uUSB-MB5 and uUSB-CE5 Adaptors) can be used.

Please note, the uUSB-PA5 is not able to be directly connected with this module, due to mechanical reasons. If used with a 5 way jumper cable then the uUSB-PA5 can be used without issue, however it cannot physically be connected direct to the display module.

The 4D programming interfaces are used to program a new Firmware/PmmC and for downloading compiled 4DGL code into the processor. They even serve as an interface for communicating serial data to the PC.

The 4D Programming Cable and uUSB-PA5 Programming Adaptor are available from 4D Systems, www.4dsystems.com.au

Using a non-4D programming interface could damage your processor, and **void your Warranty.**



4D Programming Cable



uUSB-PA5 Programming Adaptor

9. 4DGL - Software Language

The μOLED-32028-P1(T) utilises the PICASO processor, which belongs to a family of processors powered by a highly optimised soft core virtual engine, EVE (Extensible Virtual Engine).

EVE is a proprietary, high performance virtual-machine with an extensive byte-code instruction set optimised to execute compiled 4DGL programs. 4DGL (4D Graphics Language) was specifically developed from ground up for the EVE engine core. It is a high level language which is easy to learn and simple to understand yet powerful enough to tackle many embedded graphics applications.

4DGL is a graphics oriented language allowing rapid application development, and the syntax structure was designed using elements of popular languages such as C, Basic, Pascal and others.

Programmers familiar with these languages will feel right at home with 4DGL. It includes many familiar instructions such as IF..ELSE..ENDIF, WHILE..WEND, REPEAT..UNTIL, GOSUB..ENDSUB, GOTO, PRINT as well as some specialised instructions SERIN, SEROUT, GFX_LINE, GFX_CIRCLE and many more.

For detailed information pertaining to the 4DGL language, please refer to the following documents: **"4DGL-Programmers-Reference-Manual.pdf"** **"PICASO-4DGL-Internal-Functions.pdf"**

To assist with the development of 4DGL applications, the Workshop 4 IDE combines a full-featured editor, a compiler, a linker and a downloader into a single PC-based application. It's all you need to code, test and run your applications.

4DGL is available to be written in two of the four environments offered by the Workshop 4 IDE, Designer and ViSi.

10. 4D Systems - Workshop 4 IDE

Workshop 4 is a comprehensive software IDE that provides an integrated software development platform for all of the 4D family of processors and modules. The IDE combines the Editor, Compiler, Linker and Down- Loader to develop complete 4DGL application code. All user application code is developed within the Workshop 4 IDE.



The Workshop 4 IDE supports multiple development environments for the user, to cater for different user requirements and skill level.

- The **Designer** environment enables the user to write 4DGL code in its natural form to program the µOLED-32028-P1(T).
- A visual programming experience, suitably called **ViSi**, enables drag-and-drop type placement of objects to assist with 4DGL code generation and allows the user to visualise how the display will look while being developed.
- An advanced environment called **ViSi-Genie** doesn't require any 4DGL coding at all, it is all done automatically for you. Simply lay the display out with the objects you want, set the events to drive them and the code is written for you automatically. ViSi-Genie provides the latest rapid development experience from 4D Systems.
- A **Serial** environment is also provided to transform the µOLED-32028-P1(T) into a slave serial module, allowing the user to control the display from any host microcontroller or device with a serial port.

The Workshop 4 IDE is available from the 4D Systems website. www.4dsystems.com.au

For a comprehensive manual on the Workshop 4 IDE Software along with other documents, refer to the documentation from the 4D Systems website, on the Workshop 4 product page.

10.1. Workshop 4 – Designer Environment

Choose the Designer environment to write 4DGL code in its raw form.

The Designer environment provides the user with a simple yet effective programming environment where pure 4DGL code can be written, compiled and downloaded to the µOLED-32028-P1(T).

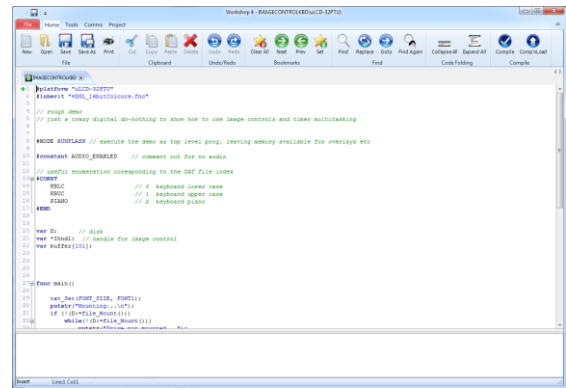

10.2. Workshop 4 – ViSi Environment

ViSi was designed to make the creation of graphical displays a more visual experience.

ViSi is a great software tool that allows the user to see the instant results of their desired graphical layout. Additionally, there is a selection of inbuilt dials, gauges and meters that can simply be placed onto the simulated module display. From here each object can have its properties edited, and at the click of a button all relevant 4DGL code associated with that object is produced in the user program. The user can then write 4DGL code around these objects to utilise them in the way they choose.

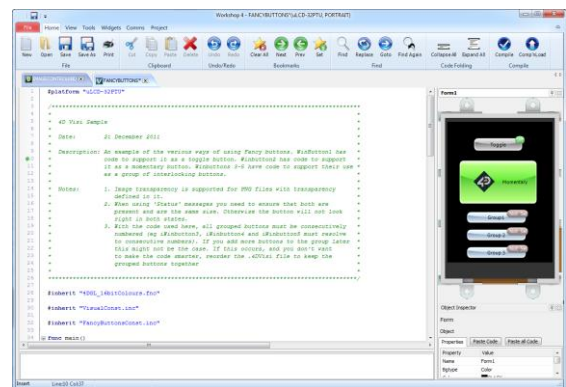

10.3. Workshop 4 – ViSi Genie Environment

ViSi Genie is a breakthrough in the way 4D Systems' graphic display modules are programmed. It is an environment like no other, a code-less programming environment that provides the user with a rapid visual experience, enabling a simple GUI application to be 'written' from scratch in literally seconds.

ViSi Genie does all the background coding, no 4DGL to learn, it does it all for you.

Pick and choose the relevant objects to place on the display, much like the ViSi Environment (See Section 11.2), yet without having to write a single line of code. Each object has parameters which can be set, and configurable events to animate and drive other objects or communicate with external devices.

Simply place an object on the screen, position and size it to suit, set the parameters such as colour, range, text, and finally select the event you wish the object to be associated with, it is that simple.

In seconds you can transform a blank display into a fully animated GUI with moving sliders, animated press and release buttons, and much more. All without writing a single line of code!

ViSi Genie provides the user with a feature rich rapid development environment, second to none.

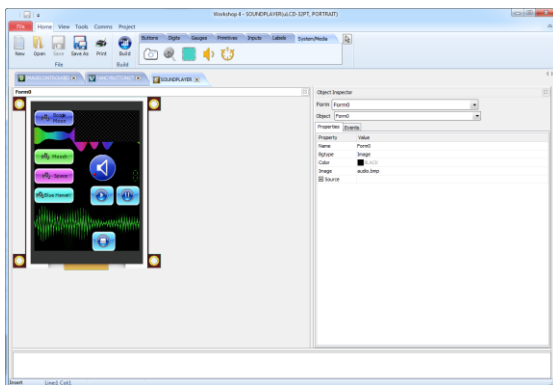

10.4. Workshop 4 – Serial Environment

The Serial environment in the Workshop 4 IDE provides the user the ability to transform the μOLED-32028-P1(T) into a slave serial graphics controller.

This enables the user to use their favourite microcontroller or serial device as the Host, without having to learn 4DGL or program in a separate IDE. Once the μOLED-32028-P1(T) is configured and downloaded to from the Serial Environment, simple graphic commands can be sent from the users host microcontroller to display primitives, images, sound or even video.

Refer to the **“Serial Command Set Reference Manual”** from the Workshop 4 product page on the 4D Systems website for a complete listing of all the supported serial commands

By default, each module shipped from the 4D Systems factory will come pre-programmed ready for use in the Serial mode.

11. Starter Kit

4D Systems highly recommends all first time buyers of 4D Systems' displays, to purchase the Starter Kit when purchasing their first 4D Systems display solution.

The Starter Kit provides all the hardware that is required to get the user up and running.

Not all development environments and features will be needed by every user, however by purchasing the display solution in a Starter Kit, it ensures that if you want to take full advantage of the 4D Systems display solution and try out each of the 4D Workshop4 Environments, upgrade PmmC/firmware, you can.

The **Designer** environment can utilise every feature of the display, however depending on the user requirements, a micro-SD (µSD) card may not be required. The µSD card is used when displaying images/video/sound, along with datalogging to µSD, and a programming cable is definitely required for downloading compiled code and PmmC/Firmware updates.

The **ViSi** environment is the same as Designer in terms of feature utilisation, but is image based so requires a µSD card, along with a programming cable.

The **ViSi-Genie** environment is also image based, and therefore requires a µSD card and programming cable also.

The **Serial** environment does not require either a µSD or Programming cable to be used, however can utilise both depending on the user requirements. The µSD card can be used for such things as storage of multimedia files and datalogging, and the Programming cable for PmmC/Firmware updates, or changing to one of the other three programming environments.

The Starter Kit includes:

- 4D Programming Adaptor or Cable
- 2Gb micro-SD Card
- 5 way cable for easy connection to a breadboard or host
- Display Module
- Quick Start Guide

Simply select the Starter Kit option when purchasing the chosen display module on the 4D Systems shopping cart, or from your local distributor.

13. Mechanical Details

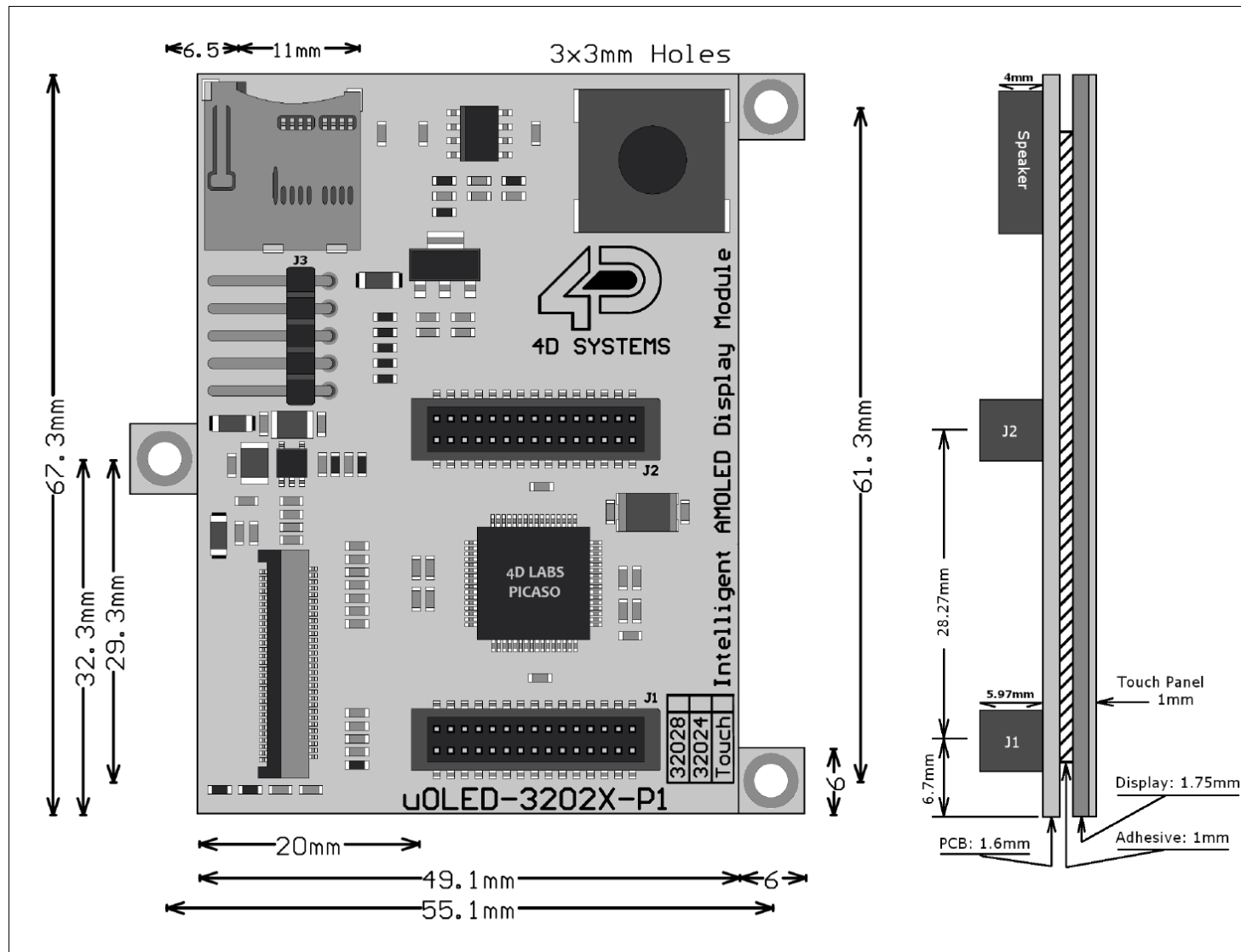

14. Schematic Diagram

2.8" AMOLED DISPLAY MODULE

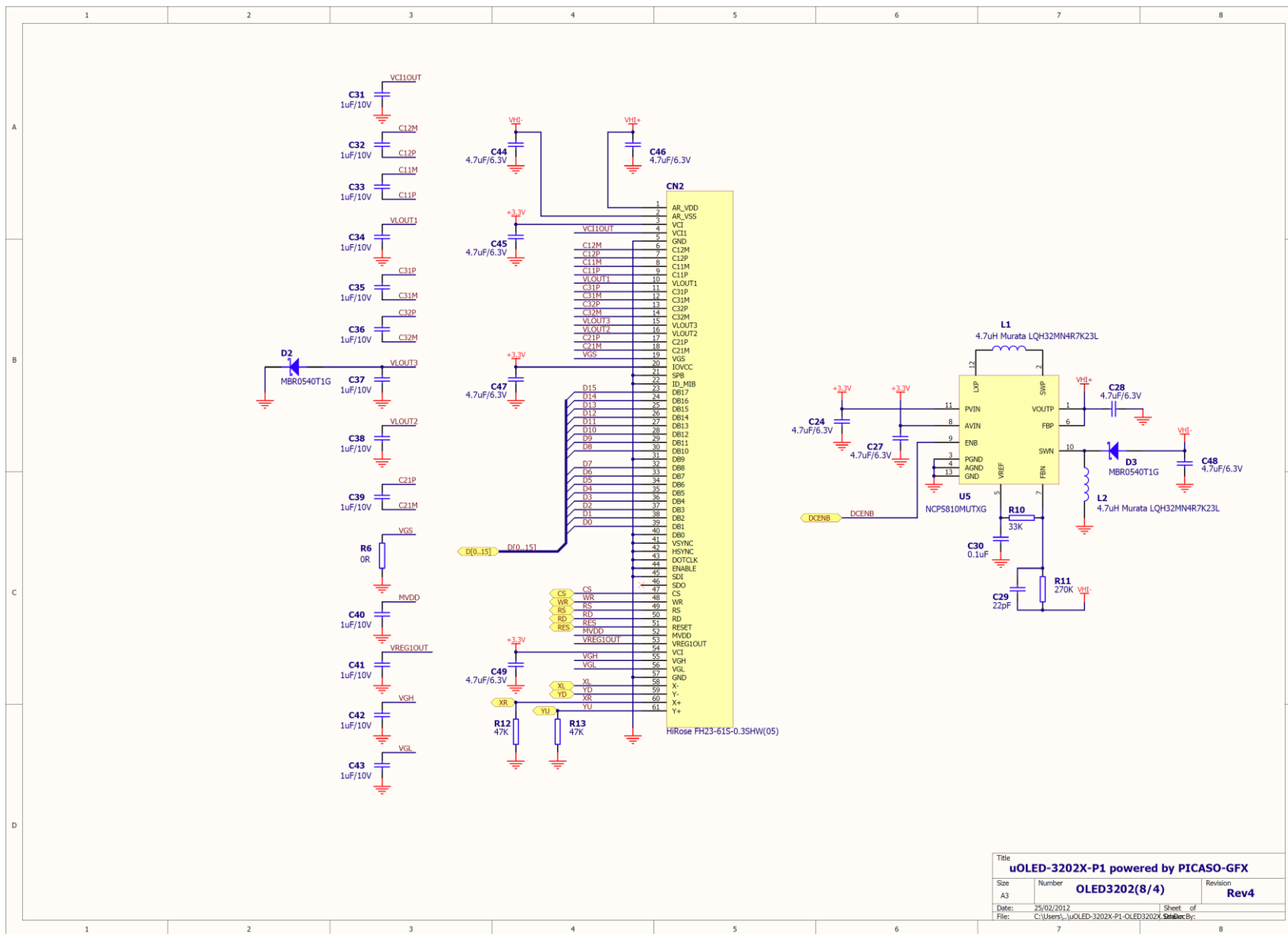

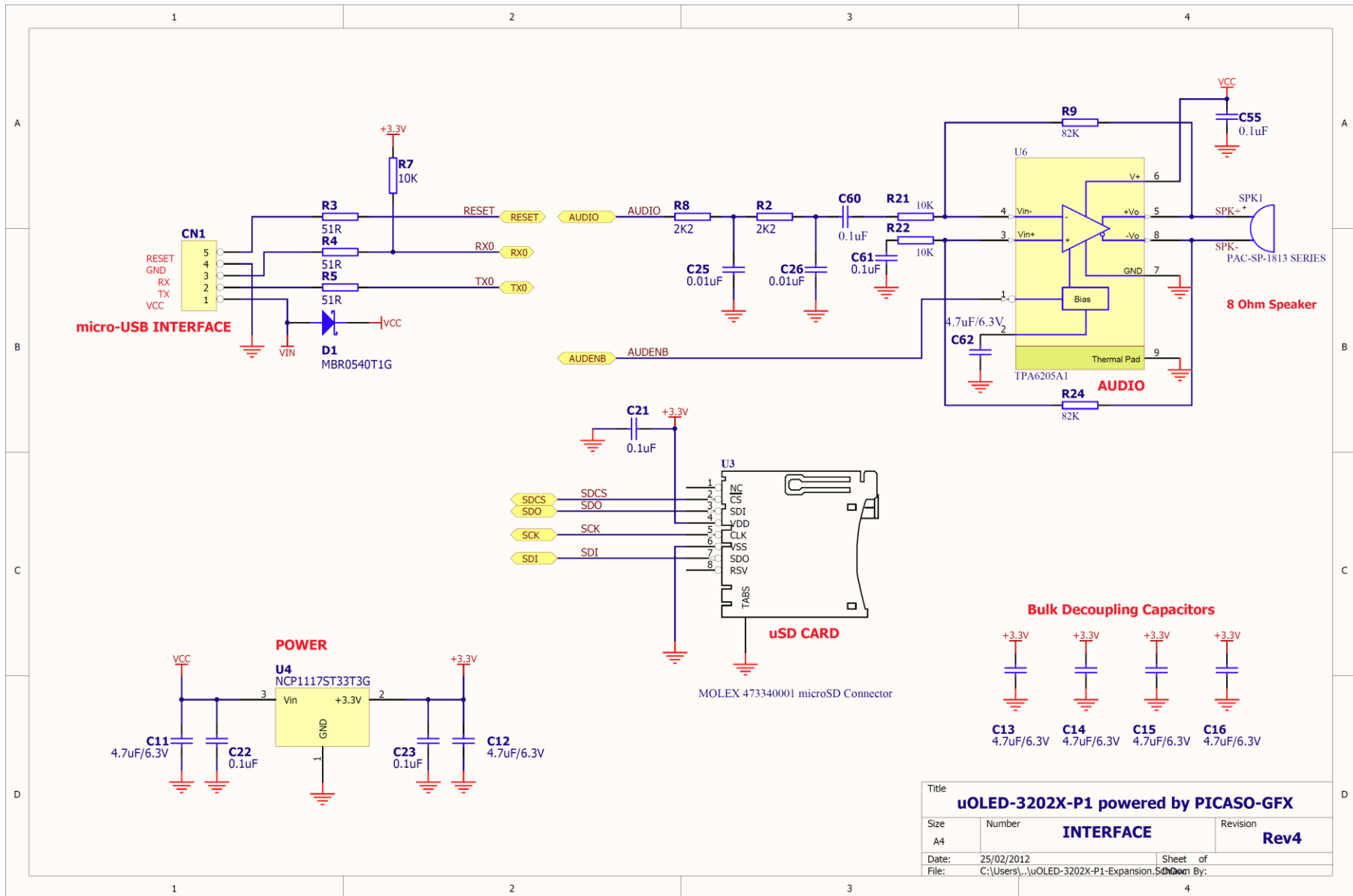

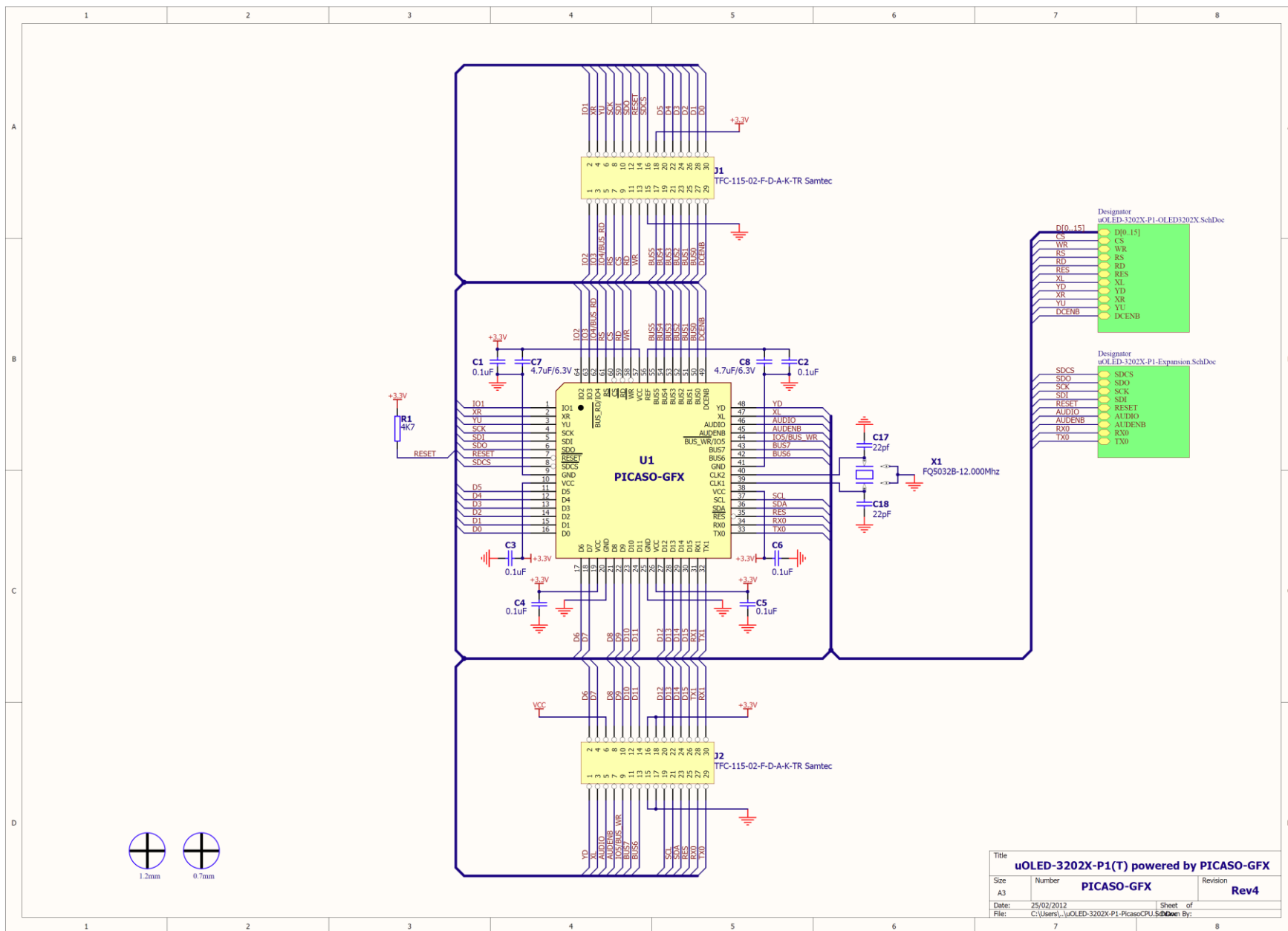

Title			
µOLED-3202X-P1(T) powered by PICASO-GFX			
Size	Number	PICASO-GFX	Revision
A3			Rev4
Date:	25/02/2012	Sheet of	
File:	C:\Users\...µOLED-3202X-P1-PicapoCPU.5	Drawn By:	

15. Specifications and Ratings

ABSOLUTE MAXIMUM RATINGS

Operating ambient temperature	-30°C to +70°C
Storage temperature	-40°C +85°C
Voltage on any digital input pin with respect to GND	-0.3V to 6.0V
Voltage on SWITCH pin with respect to GND	-0.3V to 6.0V
Voltage on VCC with respect to GND	-0.3V to 6.0V

NOTE: Stresses above those listed here may cause permanent damage to the device. This is a stress rating only and functional operation of the device at those or any other conditions above those indicated in the recommended operation listings of this specification is not implied. Exposure to maximum rating conditions for extended periods may affect device reliability.

RECOMMENDED OPERATING CONDITIONS

Parameter	Conditions	Min	Typ	Max	Units
Supply Voltage (VCC)		4.0	5.0	5.5	V
Operating Temperature		-10	--	+60	°C
Input Low Voltage (VIL)	VCC = 3.3V, all pins	VGND	--	0.2VCC	V
Input High Voltage (VIH)	VCC = 3.3V, non 5V tolerant pins	0.8VCC	--	VCC	V
Input High Voltage (VIH)	All GPIO pins, RX0 and TX0 pins	0.8VCC	--	5.5	V
Reset Pulse	External Open Collector	2.0	--	--	µs
Operational Delay	Power-Up or External Reset	500	--	3000	ms

GLOBAL CHARACTERISTICS BASED ON OPERATING CONDITIONS

Parameter	Conditions	Min	Typ	Max	Units
Supply Current (ICC)	VCC = 5.0V, heavily depends on screen usage conditions, sleep mode	4	80	160	mA
Output Low Voltage (VOL)	VCC = 5.0V, IOL = 3.4mA	--	--	0.4	V
Output High Voltage (VOH)	VCC = 5.0V, IOL = -2.0mA	2.4	--	--	V
Capacitive Loading	All pins	--	--	50	pF
Flash Memory Endurance	PICASO PmmC Programming	--	10000	--	E/W

TOUCH SCREEN CHARACTERISTICS

Parameter	Conditions	Min	Typ	Max	Units
Linearity		--	--	<1.5	%
Terminal Resistance X	X film side	200	--	900	Ohm
Terminal Resistance Y	Y film side	200	--	900	Ohm
Durability – Scratch Test	Stylus Pen or Finger Sliding	100	--	--	K
Durability – Tap Test	Stylus Pen or Finger Press	1	--	--	Million
Transparency	Non Glare	80	--	--	%

OPTICAL CHARACTERISTICS

Parameter		Condition	Min	Typ	Max	Units
Contrast ratio (CR)		Back-light On VCC = 5V	5000:1	10000:1	--	--
Luminance (L)			170	200	250	Cd/m ²
Response Time (Tres)			--	--	50	us
Colour Chromaticity (CIE 1931)	White, Wx		0.26	0.31	0.36	
	White, Wy		0.28	0.33	0.38	
	Red, Rx		0.62	0.66	0.70	
	Red, Ry		0.29	0.33	0.37	
	Green, Gx		0.25	0.29	0.33	
	Green, Gy	0.62	0.66	0.70		
	Blue, Bx	0.11	0.15	0.19		
	Blue, By	0.12	0.16	0.20		
Viewing Angle	Vertical above Centre	VCC = 5V	~ 160			Degrees
	Vertical below Centre		~ 160			
	Horizontal Left of Centre		~ 160			
	Horizontal Right of Centre		~ 160			

ORDERING INFORMATION

Order Codes:

μOLED-32028-P1T (Touch Version)

μOLED-32028-P1 (Non-Touch Version)

Package: 150mm x 95mm**Packaging:** Module sealed in antistatic foam padded 4D Systems Box

16. Legal Notice

Proprietary Information

The information contained in this document is the property of 4D Systems Pty. Ltd. and may be the subject of patents pending or granted, and must not be copied or disclosed without prior written permission.

4D Systems endeavours to ensure that the information in this document is correct and fairly stated but does not accept liability for any error or omission. The development of 4D Systems products and services is continuous and published information may not be up to date. It is important to check the current position with 4D Systems. 4D Systems reserves the right to modify, update or make changes to Specifications or written material without prior notice at any time.

All trademarks belong to their respective owners and are recognised and acknowledged.

Disclaimer of Warranties & Limitation of Liability

4D Systems makes no warranty, either expressed or implied with respect to any product, and specifically disclaims all other warranties, including, without limitation, warranties for merchantability, non-infringement and fitness for any particular purpose.

Information contained in this publication regarding device applications and the like is provided only for your convenience and may be superseded by updates. It is your responsibility to ensure that your application meets with your specifications.

Images and graphics used throughout this document are for illustrative purposes only. All images and graphics used are possible to be displayed on the 4D Systems range of products, however the quality may vary.

In no event shall 4D Systems be liable to the buyer or to any third party for any indirect, incidental, special, consequential, punitive or exemplary damages (including without limitation lost profits, lost savings, or loss of business opportunity) arising out of or relating to any product or service provided or to be provided by 4D Systems, or the use or inability to use the same, even if 4D Systems has been advised of the possibility of such damages.

4D Systems products are not fault tolerant nor designed, manufactured or intended for use or resale as on line control equipment in hazardous environments requiring fail – safe performance, such as in the operation of nuclear facilities, aircraft navigation or communication systems, air traffic control, direct life support machines or weapons systems in which the failure of the product could lead directly to death, personal injury or severe physical or environmental damage ('High Risk Activities'). 4D Systems and its suppliers specifically disclaim any expressed or implied warranty of fitness for High Risk Activities.

Use of 4D Systems' products and devices in 'High Risk Activities' and in any other application is entirely at the buyer's risk, and the buyer agrees to defend, indemnify and hold harmless 4D Systems from any and all damages, claims, suits, or expenses resulting from such use. No licenses are conveyed, implicitly or otherwise, under any 4D Systems intellectual property rights.

17. Contact Information

For Technical Support: support@4dsystems.com.au

For Sales Support: sales@4dsystems.com.au

Website: www.4dsystems.com.au

Copyright 4D Systems Pty. Ltd. 2000-2013.

Компания «Life Electronics» занимается поставками электронных компонентов импортного и отечественного производства от производителей и со складов крупных дистрибьюторов Европы, Америки и Азии.

С конца 2013 года компания активно расширяет линейку поставок компонентов по направлению коаксиальный кабель, кварцевые генераторы и конденсаторы (керамические, пленочные, электролитические), за счёт заключения дистрибьюторских договоров

Мы предлагаем:

- Конкурентоспособные цены и скидки постоянным клиентам.
- Специальные условия для постоянных клиентов.
- Подбор аналогов.
- Поставку компонентов в любых объемах, удовлетворяющих вашим потребностям.
- Приемлемые сроки поставки, возможна ускоренная поставка.
- Доставку товара в любую точку России и стран СНГ.
- Комплексную поставку.
- Работу по проектам и поставку образцов.
- Формирование склада под заказчика.
- Сертификаты соответствия на поставляемую продукцию (по желанию клиента).
- Тестирование поставляемой продукции.
- Поставку компонентов, требующих военную и космическую приемку.
- Входной контроль качества.
- Наличие сертификата ISO.

В составе нашей компании организован Конструкторский отдел, призванный помогать разработчикам, и инженерам.

Конструкторский отдел помогает осуществить:

- Регистрацию проекта у производителя компонентов.
- Техническую поддержку проекта.
- Защиту от снятия компонента с производства.
- Оценку стоимости проекта по компонентам.
- Изготовление тестовой платы монтаж и пусконаладочные работы.



Тел: +7 (812) 336 43 04 (многоканальный)
Email: org@lifeelectronics.ru