



Features

- Tx Output Power: 28dBm
- Tx Gain: 42dB
- Integrated Single Port Rx/Tx 50Ω Bi-directional Transceiver Interface
- LNA with Bypass Mode

Applications

- Wireless Automated Metering
- Wireless Alarm Systems
- Portable Battery Powered Equipment
- Smart Energy
- 868MHz/915MHz ISM Band Applications
- Single Chip RF Front End Module

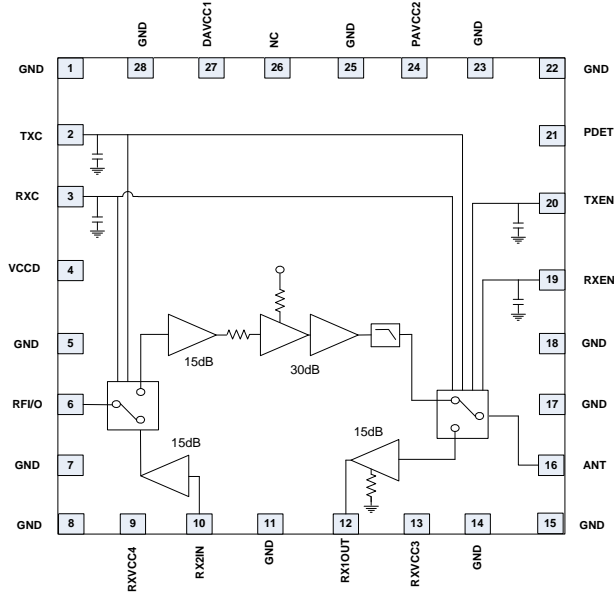

Functional Block Diagram

Product Description

The RF6559 front end module is intended for use in 915MHz AMR solutions. The RF6559 addresses the need for aggressive size reduction for a typical 915MHz AMR front end design and greatly reduces the number of components outside the RF6559 thus minimizing the footprint and assembly cost of the overall solution. The RF6559 contains an integrated three stage power amplifier which provides 42dB of Gain and typical Power output of 28dBm. The RF6559 allows for Tx/Rx on a single antenna via the 2 integrated SPDT switches. Tx filtering, built in power detector and a two stage LNA which provides a typical 32dB of gain round out the inside of this module. All the functionality of the RF6559 is packaged in a 28-pin, 6mm x 6mm laminate package with backside ground. Greatly minimizes next level board space and allows for simplified integration.

Ordering Information

RF6559	ISM Band Transmit/Receive Module
RF6559SB	5-Piece Bag
RF6559SR	Standard 100-Piece Reel
RF6559TR13	Standard 2500-Piece reel
RF6559PCK-410	Fully Assembled Evaluation Board and 5-Piece Bag

Optimum Technology Matching® Applied

- | | | | |
|--------------------------------------|--------------------------------------|-------------------------------------|------------------------------------|
| <input type="checkbox"/> GaAs HBT | <input type="checkbox"/> SiGe BiCMOS | <input type="checkbox"/> GaAs pHEMT | <input type="checkbox"/> GaN HEMT |
| <input type="checkbox"/> GaAs MESFET | <input type="checkbox"/> Si BiCMOS | <input type="checkbox"/> Si CMOS | <input type="checkbox"/> BiFET HBT |
| <input type="checkbox"/> InGaP HBT | <input type="checkbox"/> SiGe HBT | <input type="checkbox"/> Si BJT | |

RF MICRO DEVICES®, RFMD®, Optimum Technology Matching®, Enabling Wireless Connectivity™, PowerStar®, POLARIS™ TOTAL RADIO™ and UltimateBlue™ are trademarks of RFMD, LLC. BLUETOOTH is a trademark owned by Bluetooth SIG, Inc., U.S.A. and licensed for use by RFMD. All other trade names, trademarks and registered trademarks are the property of their respective owners. ©2012, RF Micro Devices, Inc.

Absolute Maximum Ratings

Parameter	Rating	Unit
Battery Voltage	5.25	V
RF Input Power	-8	dBm
Operating Temperature	-40 to +105	°C
Storage Temperature	-40 to +150	°C
ESD, HBM (All Pins)	750	V
ESD, CDM (All Pins)	750	V
MSL	MSL 3	



Caution! ESD sensitive device.

Exceeding any one or a combination of the Absolute Maximum Rating conditions may cause permanent damage to the device. Extended application of Absolute Maximum Rating conditions to the device may reduce device reliability. Specified typical performance or functional operation of the device under Absolute Maximum Rating conditions is not implied.

The information in this publication is believed to be accurate and reliable. However, no responsibility is assumed by RF Micro Devices, Inc. ("RFMD") for its use, nor for any infringement of patents, or other rights of third parties, resulting from its use. No license is granted by implication or otherwise under any patent or patent rights of RFMD. RFMD reserves the right to change component circuitry, recommended application circuitry and specifications at any time without prior notice.



RFMD Green: RoHS compliant per EU Directive 2002/95/EC, halogen free per IEC 61249-2-21, < 1000ppm each of antimony trioxide in polymeric materials and red phosphorus as a flame retardant, and <2% antimony in solder.

Parameter	Specification			Unit	Condition
	Min.	Typ.	Max.		
Specifications					
Frequency	868	902 to 928		MHz	
RF Port Impedance		50		Ω	
Operating Voltage	4.0	4.2	4.5	V	
Module Leakage Current		1.64		μA	
Tx High Power Mode					
Input Power	-16	-10	-8	dBm	
PSA	27		30	dBm	P _{SAT}
Operating Output Power (+85 °C to +105 °C)	26			dBm	P _{SAT}
Large Signal Gain	38	42		dB	
Input Return Loss	7	8		dB	
Operating Current		340	385	mA	
P _{DET} Voltage Range	1		3	V	
P _{DET} Power Range	20		30	dBm	
P _{DET} Gradient		TBD			
P _{DET} Temperature Variation		TBD			
Stability	10:1				
Rx Mode					
Gain	28	32	35	dB	
Current	6	8	20	mA	
NF		1.8	2.2	dB	
Input IP3	-18	-11		dBm	
Input P1dB	-23	-20		dBm	
Input Return Loss	3.5	5		dB	
Output Return Loss	10	12		dB	
Antenna Switch Section					
Isolation	20	36		dB	Any used port to any unused port
2Fo Harmonic		-43	-5	dBc	
3Fo Harmonic		-50	-45	dBc	
4Fo Harmonic		-53	-45	dBc	
5Fo Harmonic		-43	-40	dBc	
6Fo to 10Fo Harmonic		-46	-45	dBc	

Parameter	Specification			Unit	Condition
	Min.	Typ.	Max.		
RF Switch Section					
Isolation	20			dB	
Return Loss (Rx)	10	15		dB	
Return Loss (Tx)	10	15		dB	
Logic Circuit and Power Supply					
V _{CC_DIG}	4.0	4.2	4.5	V	Digital Supply Voltage
I _{CC_DIG} : Rx Mode		5	8	mA	
I _{CC_DIG} : Tx Mode		7	12	mA	
Control Logic: High	2.7	4.0	4.3	V	
Control Logic: Low		0.2	0.3	V	
Control Logic: High Current TXC and RXC		0.1	0.5	μA	
Control Logic: RXEN		20	100	μA	
Control Logic: TXEN		140	500	μA	
Control Logic: Low Current		0.1	1	μA	TXC, RXC, RX Enable, TX Enable

Operating Mode	Logic Table				Typical Current Draw (mA)			
	TXC	RXC	TXEN	RXEN	Total	TX	RX	Digital
Tx	High	Low	High	Low	337	330	0.00064	7
Rx	Low	High	Low	High	17	0.0005	12	5
All Off	Low	Low	Low	Low	0.00164	0.0005	0.00064	0.0005

NOTES:

*Switch Control Logic High = Min 2.7V to Max 4.3V

*Switch Control Logic Low = Min 0.0V to Max 0.3V

Pin Out

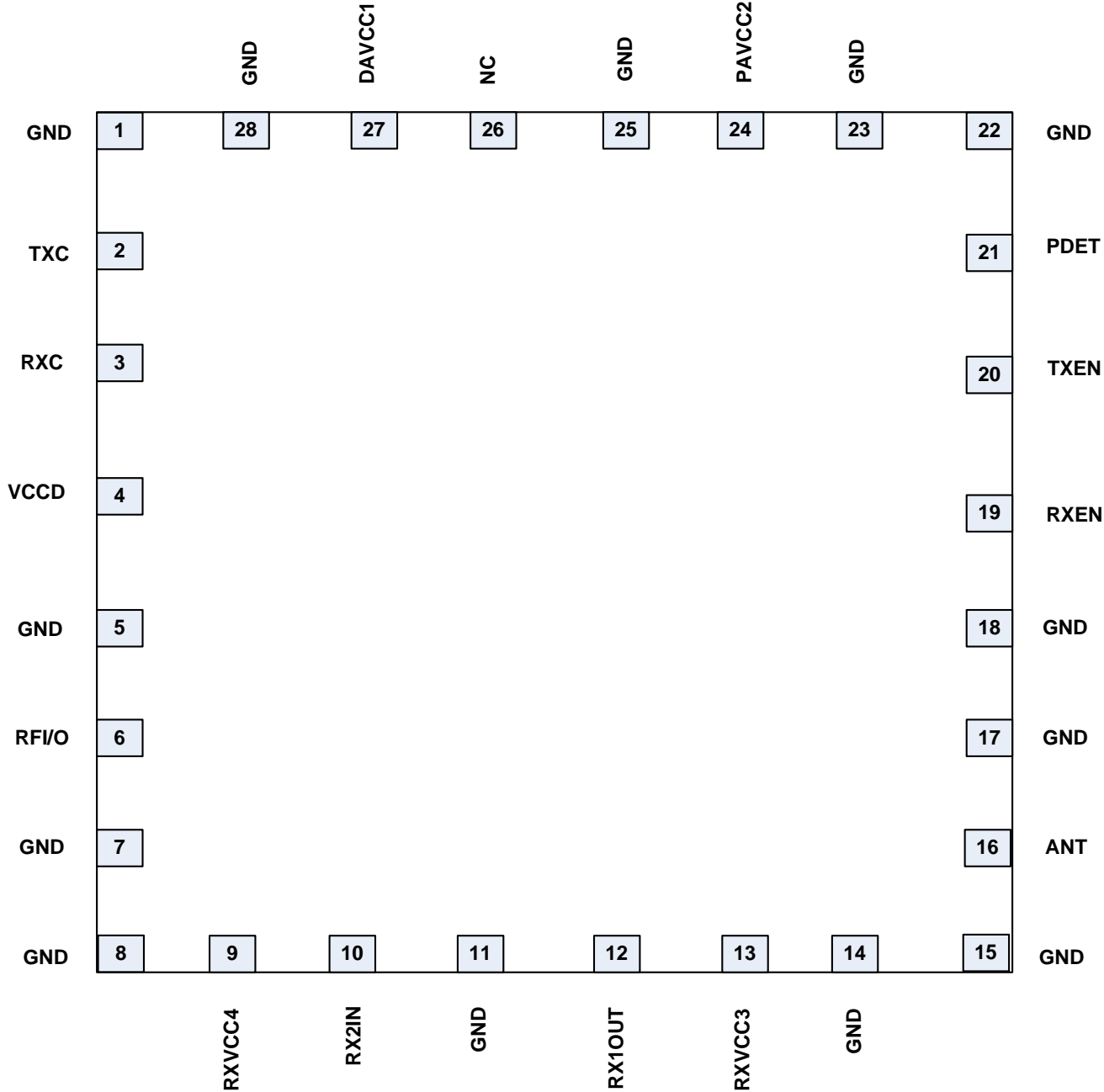

Pin Names and Descriptions

Pin	Name	Description
1	GND	Corner Ground
2	TXC	Tx Switch Control Input
3	RXC	Rx Switch Control Input
4	VCCD	Digital Reference Voltage Input
5	GND	Ground
6	RFI/O	Module RF Tx Input / Rx Output, DC Blocked
7	GND	Ground
8	GND	Corner Ground
9	RXVCC4	LNA 2 nd Stage Battery Bias
10	RX2IN	LNA 2 nd Stage RF Input
11	GND	Ground
12	RX1OUT	LNA 1 st Stage RF Output
13	RXVCC3	LNA 1 st Stage Battery Bias
14	GND	Ground
15	GND	Corner Ground
16	ANT	Antenna RF Output/Input, DC Blocked
17	GND	Ground
18	GND	Ground
19	RXEN	Enable Voltage Input for Receive Channel
20	TXEN	Enable Voltage Input for Transmit Channel
21	PDET	PA Power Detected Voltage Output
22	GND	Corner Ground
23	GND	Ground
24	PAVCC2	Battery Bias Input for Final PA Stage
25	GND	Ground
26	NC	No Connect
27	DAVCC1	Battery Bias Input for Driver Stage
28	GND	Ground
29	GND	Center Ground Flag

Evaluation Board Schematic

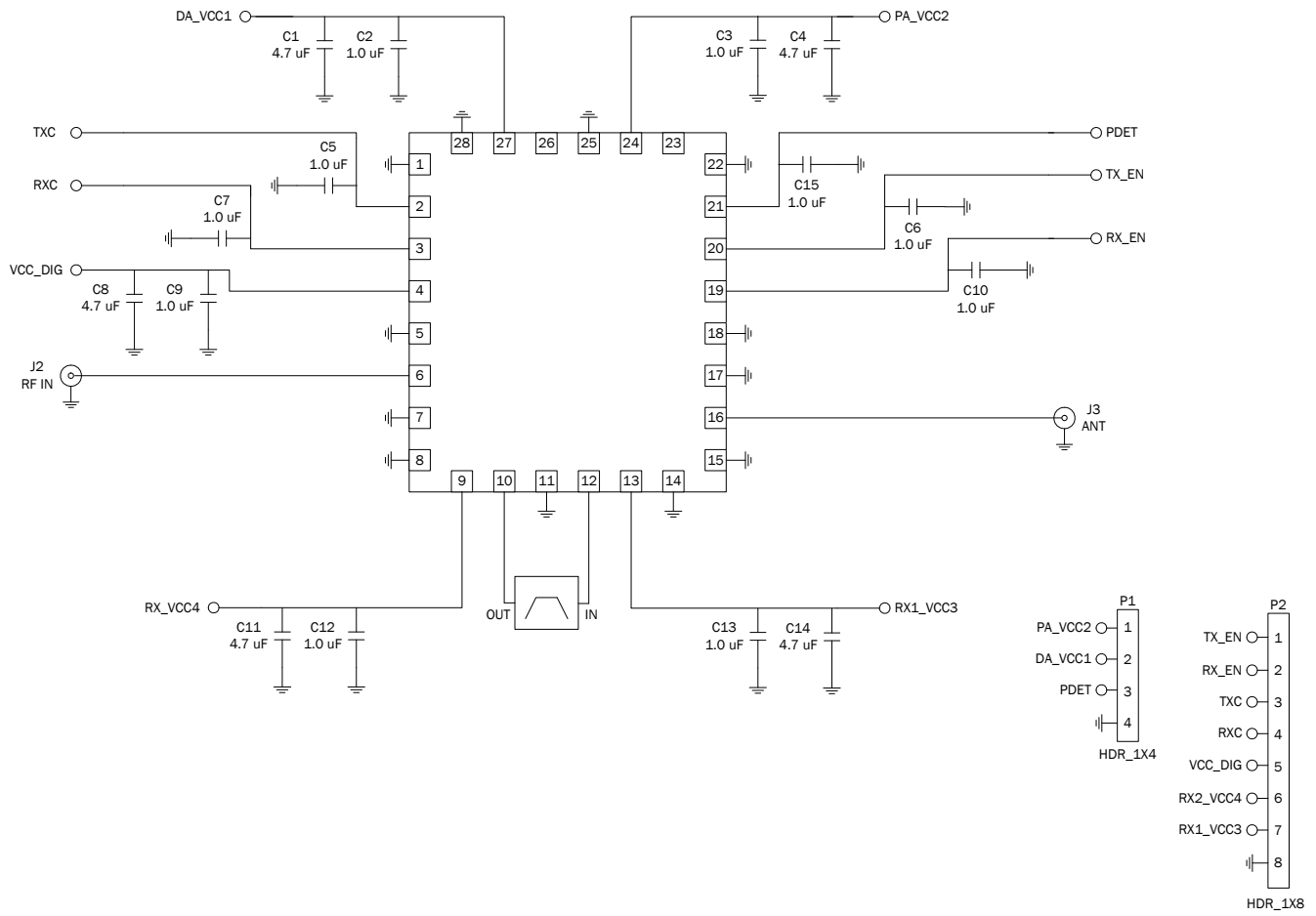

**Package Drawing
28-pin, 6mm x 6mm**

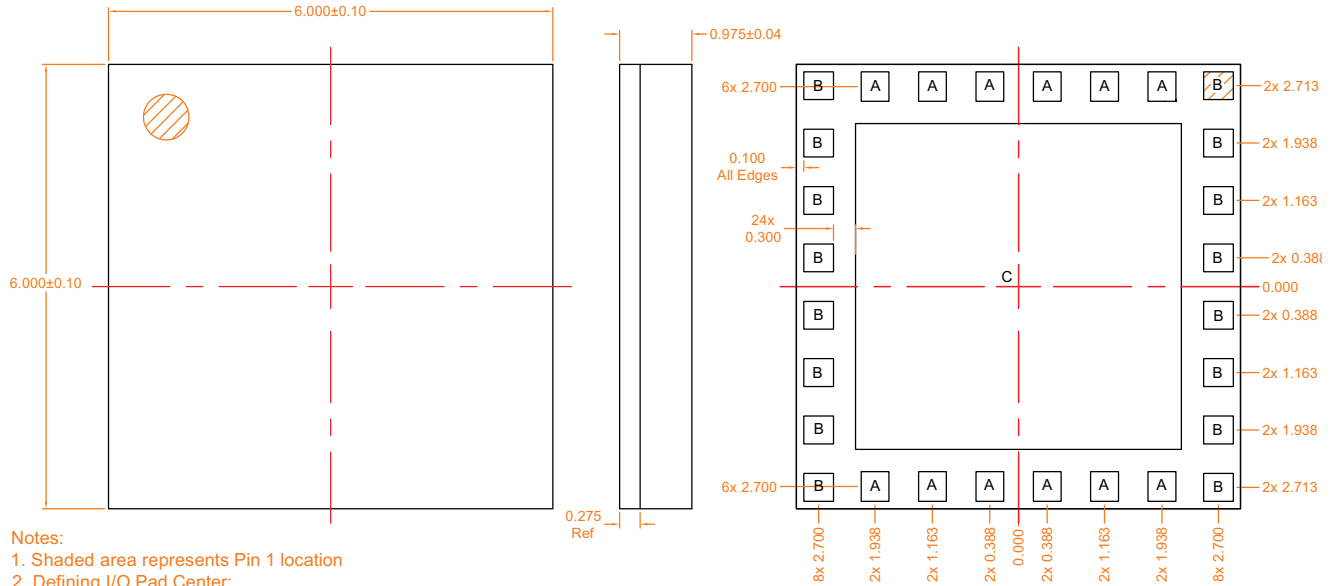

- Notes:
1. Shaded area represents Pin 1 location
 2. Defining I/O Pad Center:
To define center of the I/O pad opening, draw a right triangle in one corner of the I/O pad
Then take the center of the hypotenuse to determine center of I/O pad

A = 0.375 x 0.400 mm
 B = 0.400 x 0.375 mm
 C = 4.400 x 4.400 mm

PCB Design Requirements

PCB Surface Finish

The PCB surface finish used for RFMD's qualification process is electroless nickel, immersion gold. Typical thickness is 3µinch to 8µinch gold over 180µinch nickel.

PCB Land Pattern Recommendation

PCB land patterns for RFMD components are based on IPC-7351 standards and RFMD empirical data. The pad pattern shown has been developed and tested for optimized assembly at RFMD. The PCB land pattern has been developed to accommodate lead and package tolerances. Since surface mount processes vary from company to company, careful process development is recommended.

PCB Metal Land and Solder Mask Pattern

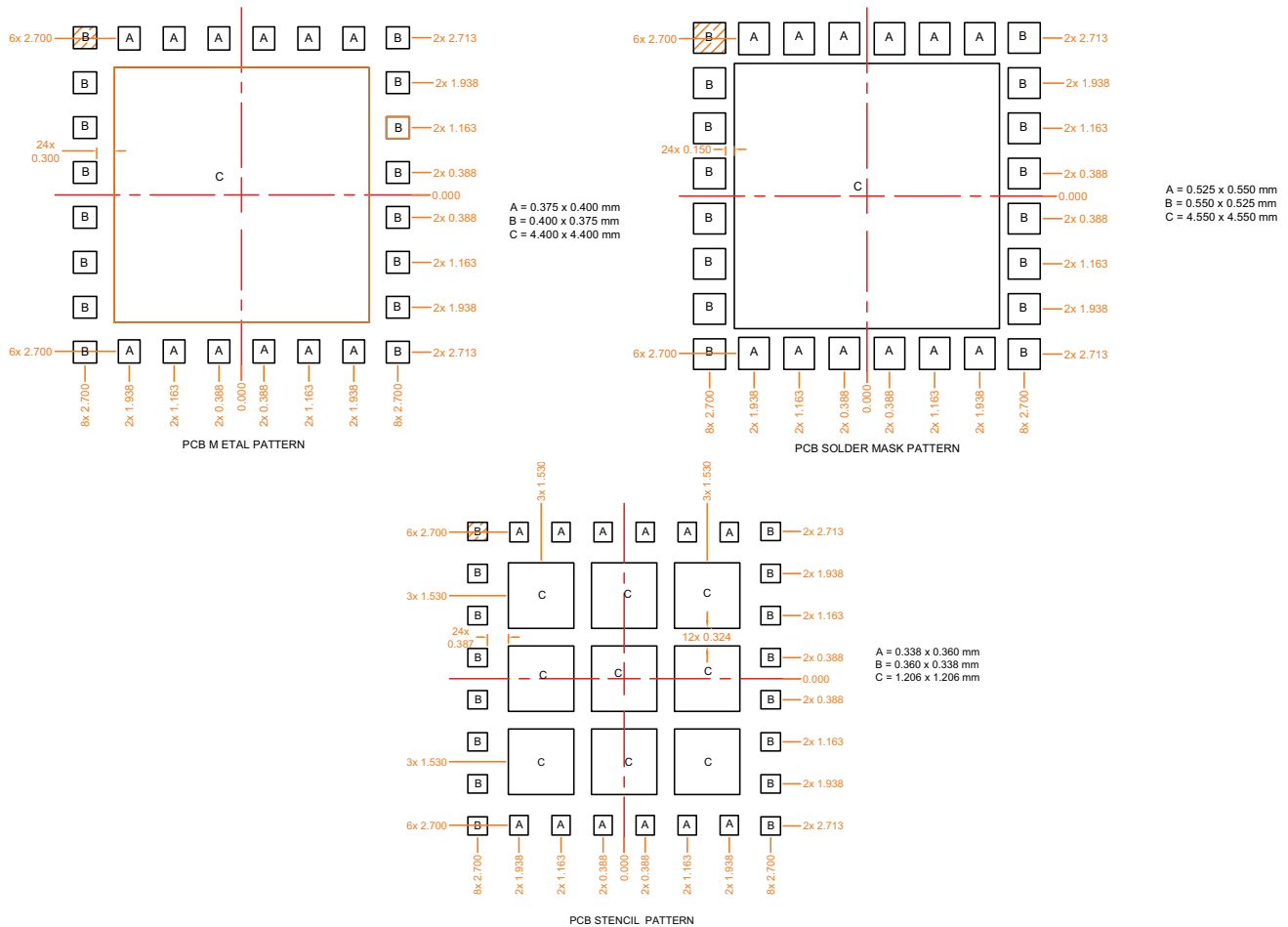

Notes:
Shaded area represents PIN 1.

Typical Performance

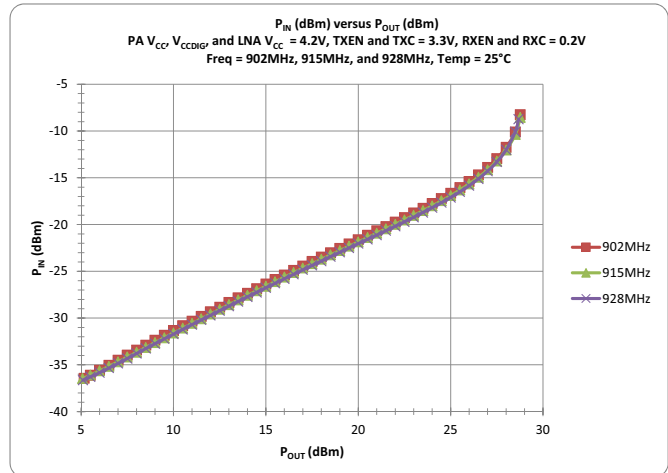
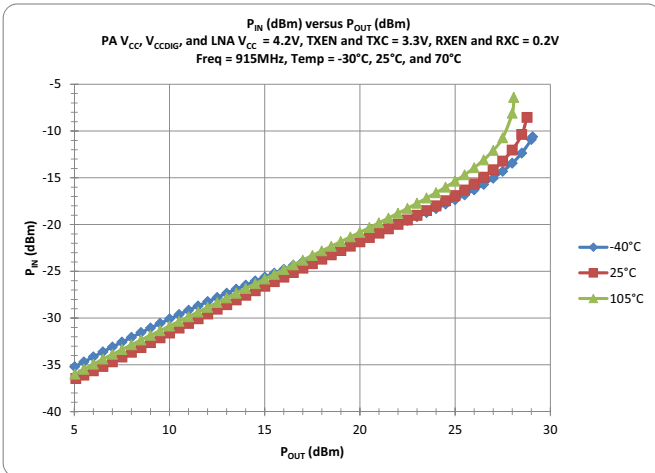
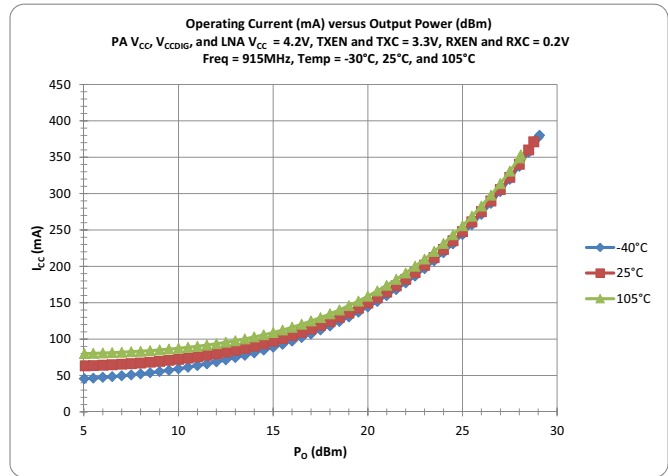
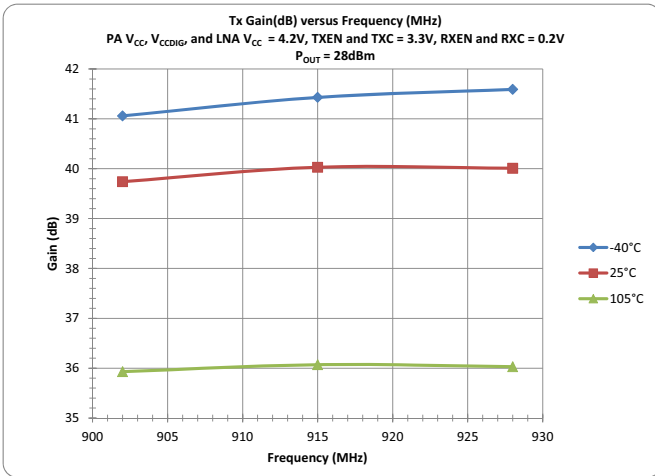
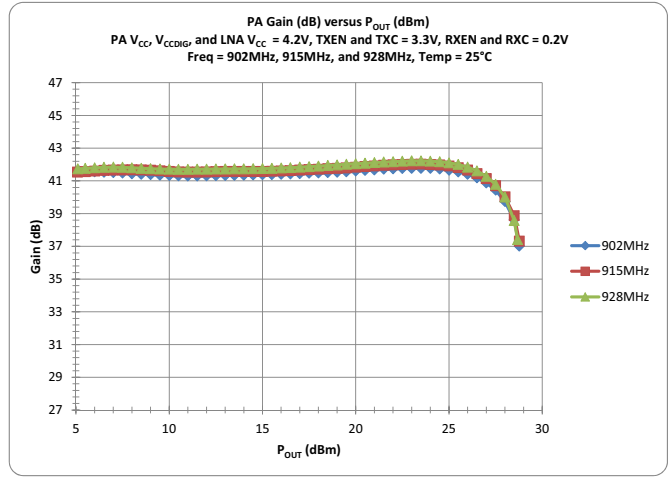
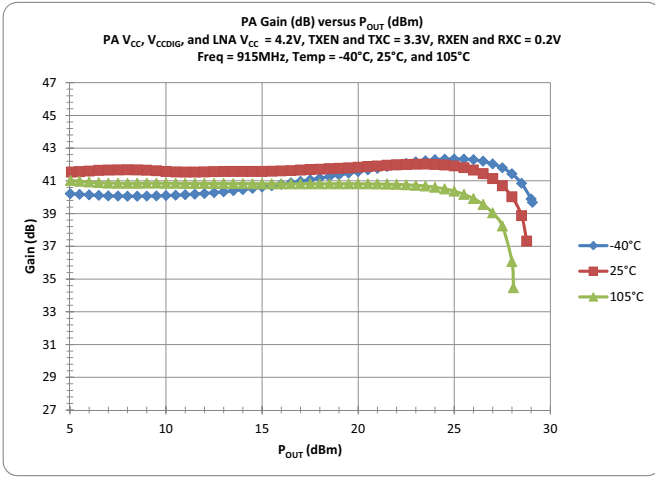

Typical Performance

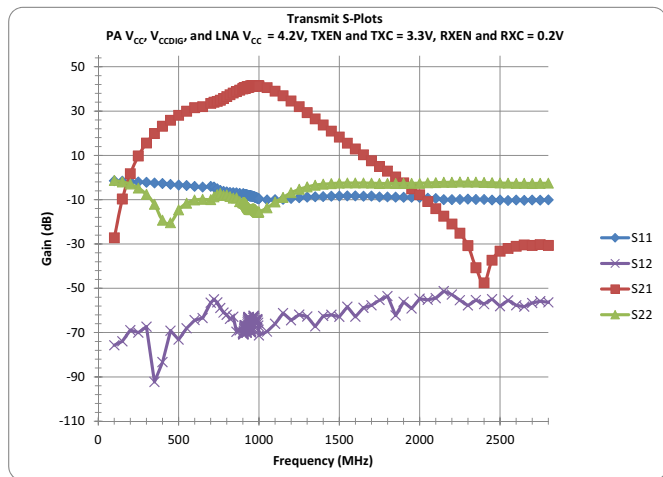
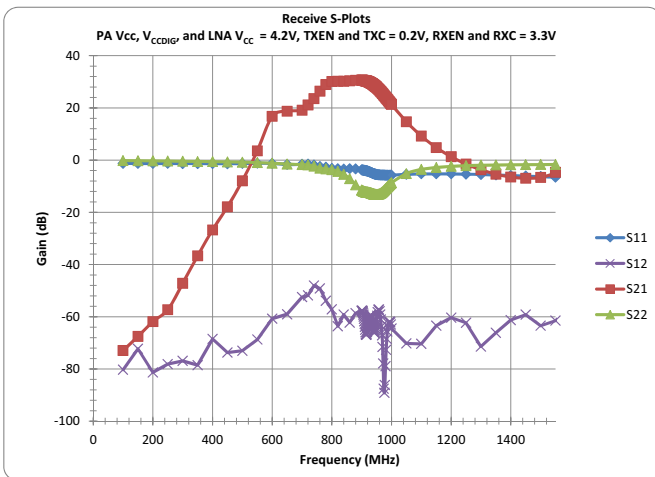
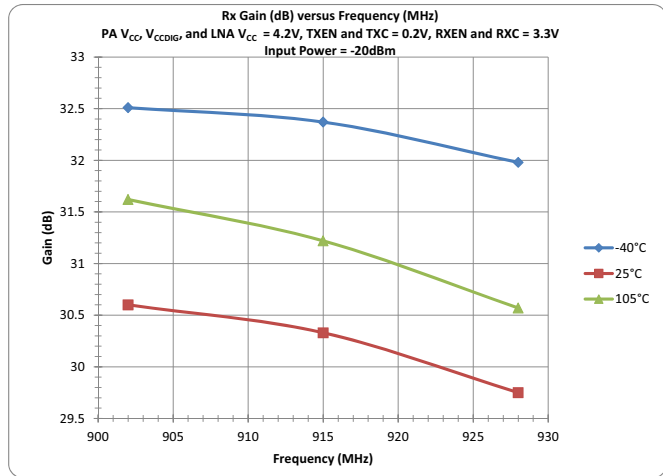
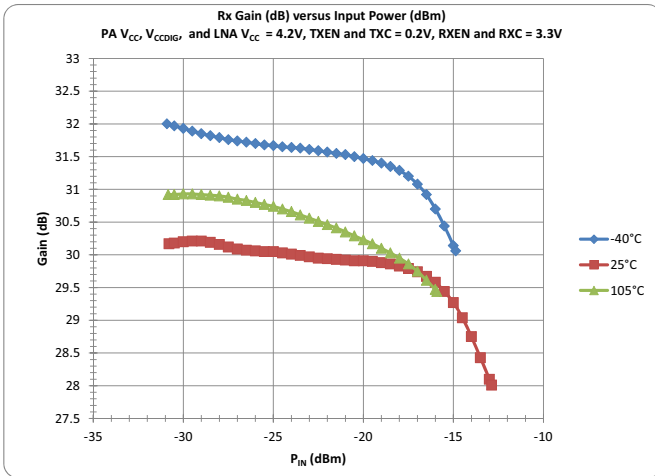

Компания «Life Electronics» занимается поставками электронных компонентов импортного и отечественного производства от производителей и со складов крупных дистрибьюторов Европы, Америки и Азии.

С конца 2013 года компания активно расширяет линейку поставок компонентов по направлению коаксиальный кабель, кварцевые генераторы и конденсаторы (керамические, пленочные, электролитические), за счёт заключения дистрибьюторских договоров

Мы предлагаем:

- Конкурентоспособные цены и скидки постоянным клиентам.
- Специальные условия для постоянных клиентов.
- Подбор аналогов.
- Поставку компонентов в любых объемах, удовлетворяющих вашим потребностям.
- Приемлемые сроки поставки, возможна ускоренная поставка.
- Доставку товара в любую точку России и стран СНГ.
- Комплексную поставку.
- Работу по проектам и поставку образцов.
- Формирование склада под заказчика.
- Сертификаты соответствия на поставляемую продукцию (по желанию клиента).
- Тестирование поставляемой продукции.
- Поставку компонентов, требующих военную и космическую приемку.
- Входной контроль качества.
- Наличие сертификата ISO.

В составе нашей компании организован Конструкторский отдел, призванный помогать разработчикам, и инженерам.

Конструкторский отдел помогает осуществить:

- Регистрацию проекта у производителя компонентов.
- Техническую поддержку проекта.
- Защиту от снятия компонента с производства.
- Оценку стоимости проекта по компонентам.
- Изготовление тестовой платы монтаж и пусконаладочные работы.



Тел: +7 (812) 336 43 04 (многоканальный)

Email: org@lifeelectronics.ru