

## RONDA-WAS

Asymmetric beam for wall washing with holder  
A compatible with 3rd party connectors from TE,  
Bender+Wirth and IDEAL

### TECHNICAL SPECIFICATIONS:

Dimensions	Ø 69.9 mm
Height	21.8 mm
Fastening	socket
ROHS compliant	yes ⓘ

### MATERIAL SPECIFICATIONS:

Component	Type	Material	Colour	Finish
RONDA-WAS	Single lens	PMMA	clear	
RONDA-HLD-A	Holder	PC	white	



### ORDERING INFORMATION:

Component		Qty in box	MOQ	MPQ	Box weight (kg)
FN15380_RONDA-WAS	Single lens	420	120	30	0.0
» Box size:					

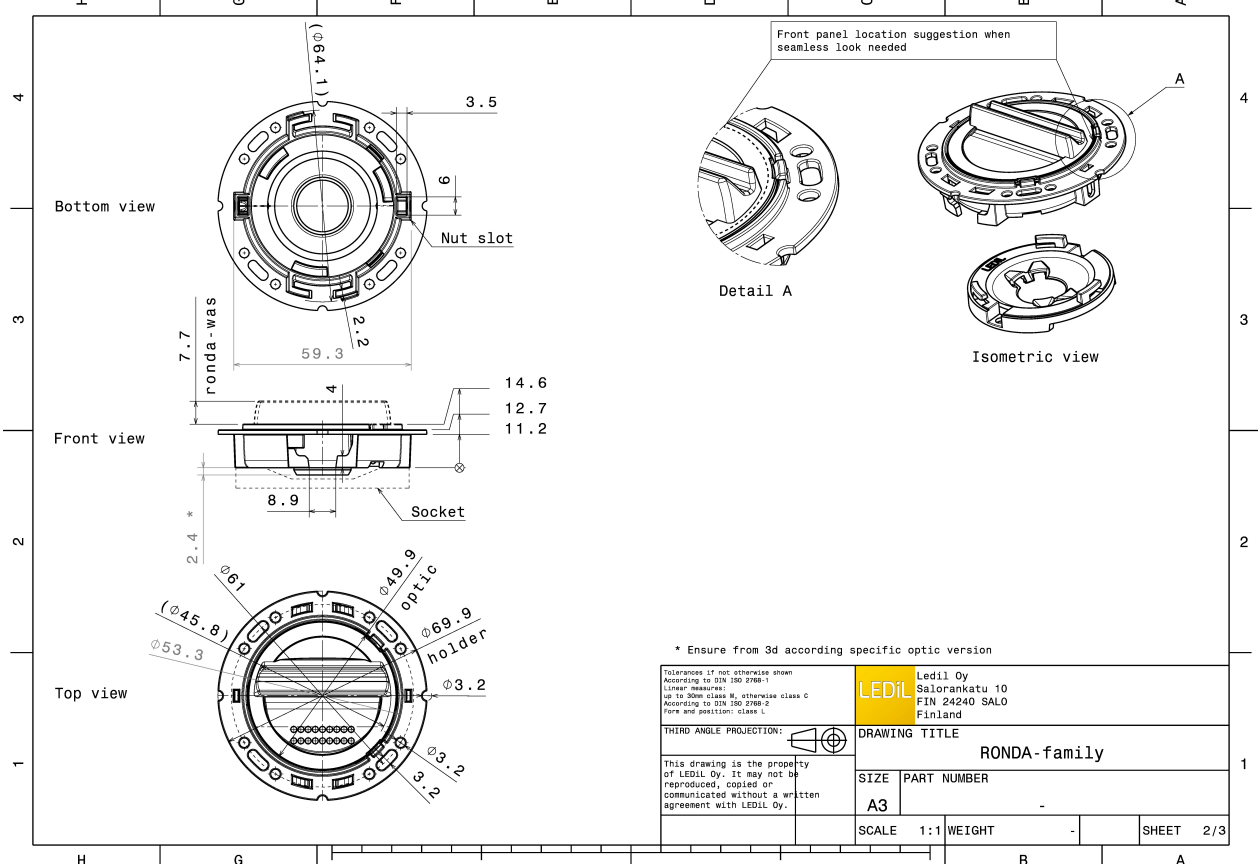
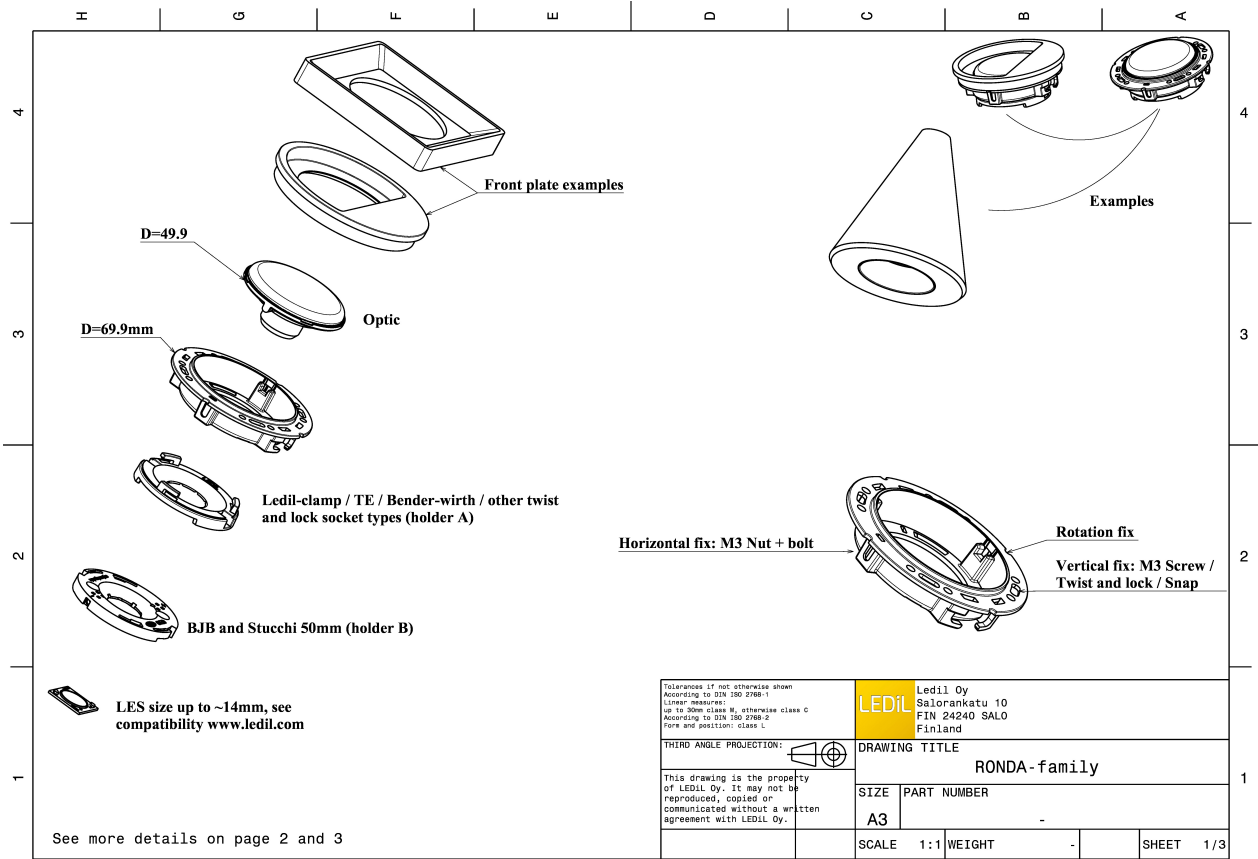

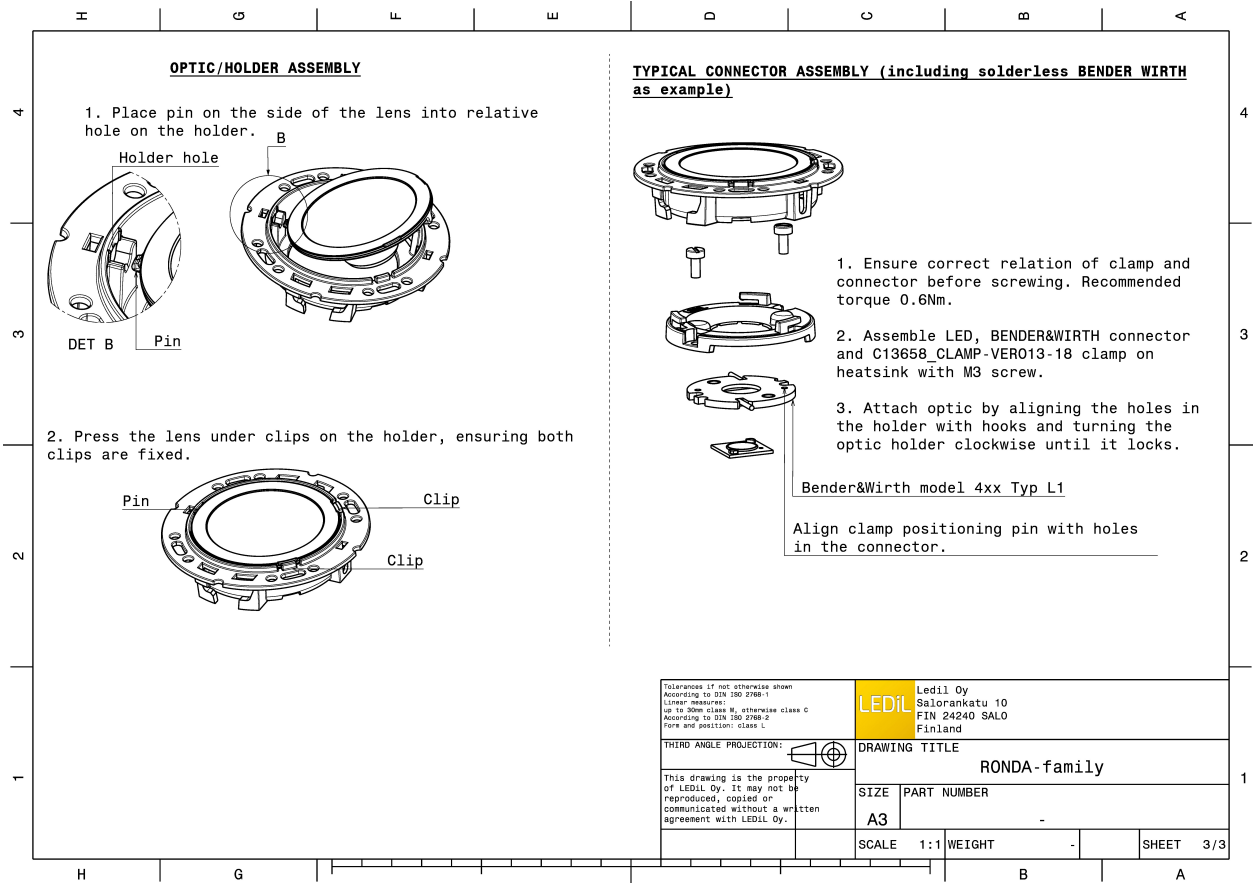

#### PHOTOMETRIC DATA (MEASURED):

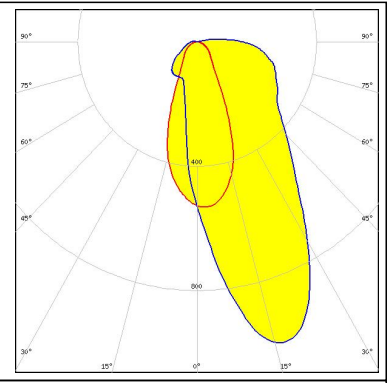
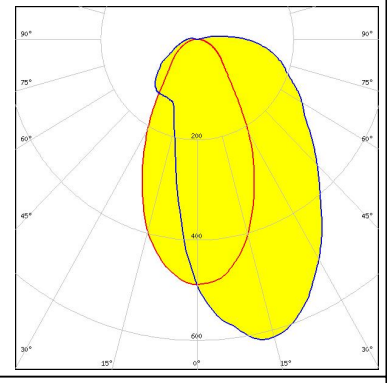
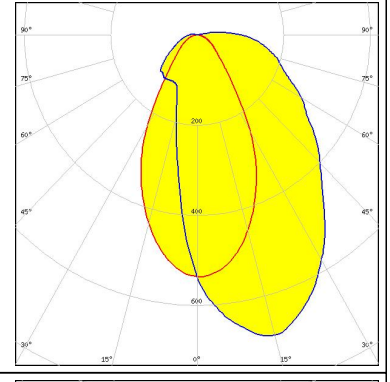
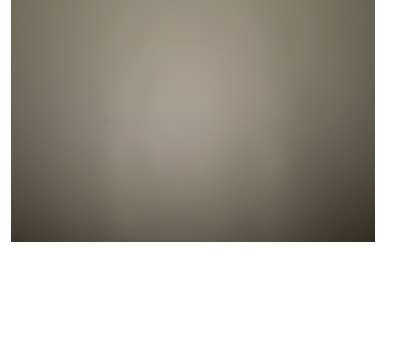
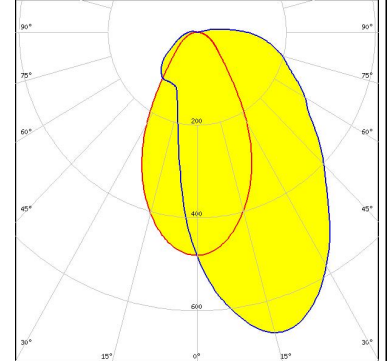
<p>bridgelux.</p> <p>LED V10 Gen7</p> <p>FWHM Asymmetric</p> <p>Efficiency 88 %</p> <p>Peak intensity 1 cd/lm</p> <p>LEDs/each optic 1</p> <p>Light colour White</p> <p>Required components: C13658_CLAMP-VERO13-18 Bender Wirth: 486 Typ L1</p>		
<p>bridgelux.</p> <p>LED V13 Gen7</p> <p>FWHM Asymmetric</p> <p>Efficiency 84 %</p> <p>Peak intensity 0.6 cd/lm</p> <p>LEDs/each optic 1</p> <p>Light colour White</p> <p>Required components: TE: 2213254-2 + OPTIC CLIP Z50 TYPE1 2213194-1</p>		
<p>bridgelux.</p> <p>LED Vero SE 13</p> <p>FWHM Asymmetric</p> <p>Efficiency 89 %</p> <p>Peak intensity 0.7 cd/lm</p> <p>LEDs/each optic 1</p> <p>Light colour White</p> <p>Required components: C16402_CLAMP-VEROSE-13-18</p>		
<p>bridgelux.</p> <p>LED VERO13</p> <p>FWHM Asymmetric</p> <p>Efficiency 89 %</p> <p>Peak intensity 0.7 cd/lm</p> <p>LEDs/each optic 1</p> <p>Light colour White</p> <p>Required components: C13658_CLAMP-VERO13-18</p>		



#### PHOTOMETRIC DATA (MEASURED):

#### CITIZEN

LED CLL03x/CLU03x  
 FWHM Asymmetric  
 Efficiency 84 %  
 Peak intensity 0.6 cd/lm  
 LEDs/each optic 1  
 Light colour White  
 Required components:  
 IDEAL: 50-2103CT + 50-2100AN

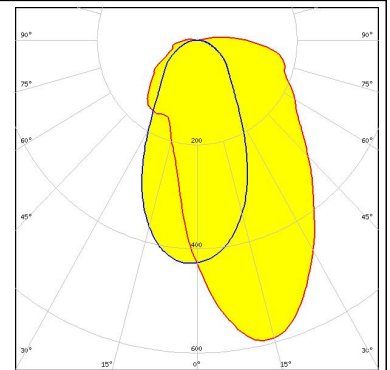

#### CITIZEN

LED CLL03x/CLU03x  
 FWHM Asymmetric  
 Efficiency 87 %  
 Peak intensity 0.6 cd/lm  
 LEDs/each optic 1  
 Light colour White  
 Required components:  
 C16791\_CLAMP-Z45-A  
 TE: 2325807-3

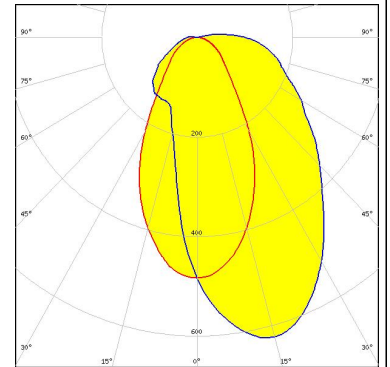

#### CITIZEN

LED CLL04x/CLU04x  
 FWHM Asymmetric  
 Efficiency 84 %  
 Peak intensity 0.5 cd/lm  
 LEDs/each optic 1  
 Light colour White  
 Required components:  
 IDEAL: 50-2204-CT + 50-2100AN

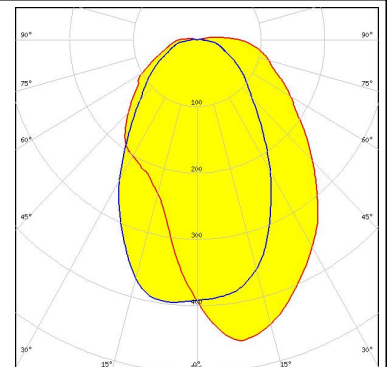

#### CITIZEN

LED CLU730/731  
 FWHM Asymmetric  
 Efficiency 85 %  
 Peak intensity 0.6 cd/lm  
 LEDs/each optic 1  
 Light colour White  
 Required components:  
 IDEAL: 50-2204-CT + 50-2100AN

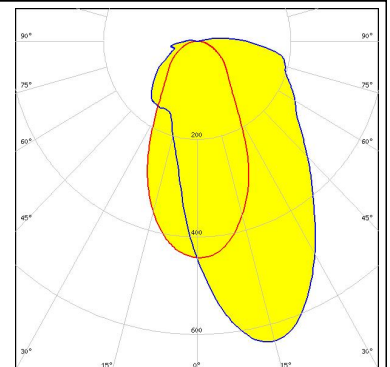

#### PHOTOMETRIC DATA (MEASURED):



LED CMA1840  
 FWHM Asymmetric  
 Efficiency 89 %  
 Peak intensity 0.6 cd/lm  
 LEDs/each optic 1  
 Light colour White  
 Required components:  
 C14123\_CLAMP-CXA15-18

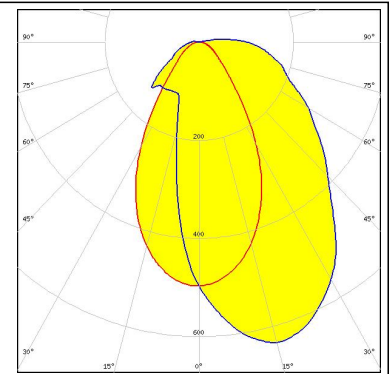
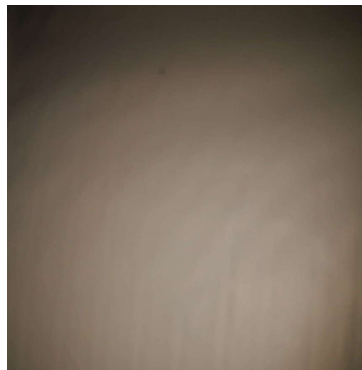

LED CXA/B 15xx  
 FWHM Asymmetric  
 Efficiency 91 %  
 Peak intensity 1 cd/lm  
 LEDs/each optic 1  
 Light colour White  
 Required components:  
 C14123\_CLAMP-CXA15-18

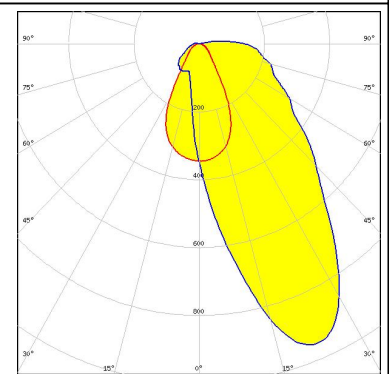

LED CXA/B 1816 & CXA/B 1820 & CXA 1850  
 FWHM Asymmetric  
 Efficiency 87 %  
 Peak intensity 0.7 cd/lm  
 LEDs/each optic 1  
 Light colour White  
 Required components:  
 TE: 2213401-2 + OPTIC CLIP Z50 TYPE1 2213194-1

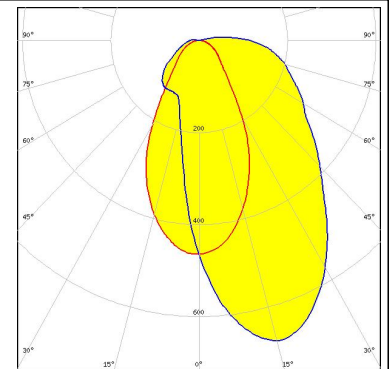
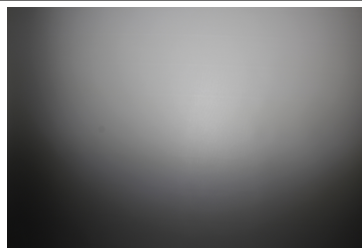

LED CXA/B 1816 & CXA/B 1820 & CXA 1850  
 FWHM Asymmetric  
 Efficiency 91 %  
 Peak intensity 0.7 cd/lm  
 LEDs/each optic 1  
 Light colour White  
 Required components:  
 C14123\_CLAMP-CXA15-18

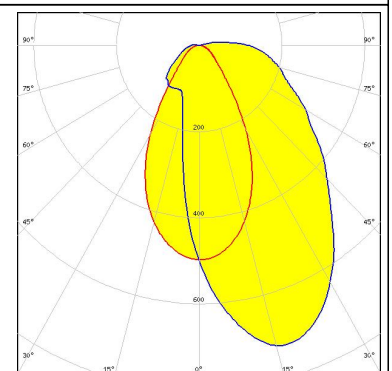

#### PHOTOMETRIC DATA (MEASURED):

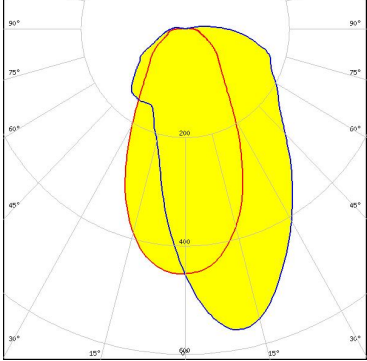
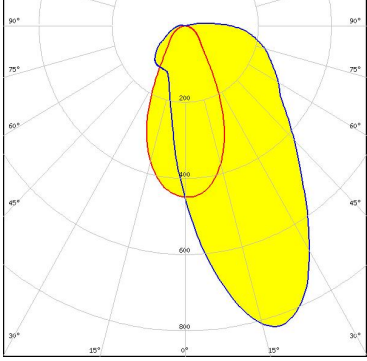
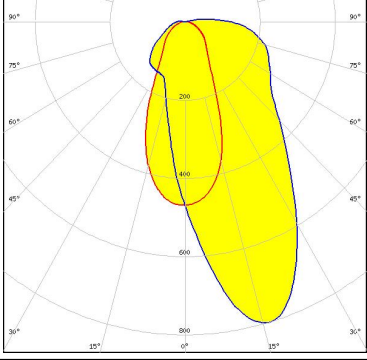
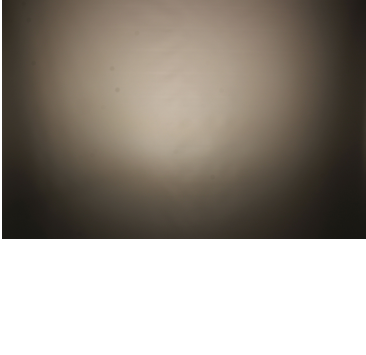
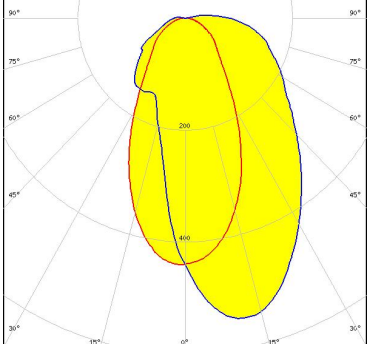
<p><b>NICHIA</b></p> <p>LED COB J-Type            FWHM Asymmetric            Efficiency 83 %            Peak intensity 0.6 cd/lm            LEDs/each optic 1            Light colour White            Required components:            IDEAL: 50-2103NC + 50-2100AN</p>		
<p><b>NICHIA</b></p> <p>LED COB L-Type (LES 11)            FWHM Asymmetric            Efficiency 87 %            Peak intensity 0.8 cd/lm            LEDs/each optic 1            Light colour White            Required components:            TE: 2213382-2 + OPTIC CLIP Z50 TYPE1 2213194-1</p>		
<p><b>NICHIA</b></p> <p>LED COB L-Type (LES 11)            FWHM Asymmetric            Efficiency 84 %            Peak intensity 0.8 cd/lm            LEDs/each optic 1            Light colour White            Required components:            IDEAL: 50-2100NC + 50-2100AN</p>		
<p><b>OSRAM</b></p> <p>LED PrevaLED Core G7 L15 H1            FWHM Asymmetric            Efficiency 78 %            Peak intensity 0.6 cd/lm            LEDs/each optic 1            Light colour White            Required components:            C16685_CLAMP-PRV-A</p>		

#### PHOTOMETRIC DATA (MEASURED):

#### OSRAM

Opto Semiconductors

LED Soleriq S13 19x19  
 FWHM Asymmetric  
 Efficiency 86 %  
 Peak intensity 0.7 cd/lm  
 LEDs/each optic 1  
 Light colour White  
 Required components:  
 TE: 2213254-2 + OPTIC CLIP Z50 TYPE1 2213194-1

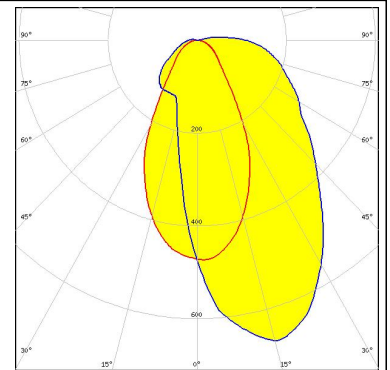

#### OSRAM

Opto Semiconductors

LED Soleriq S13 19x19  
 FWHM Asymmetric  
 Efficiency 85 %  
 Peak intensity 0.7 cd/lm  
 LEDs/each optic 1  
 Light colour White  
 Required components:  
 IDEAL: 50-2103CT + 50-2100AN

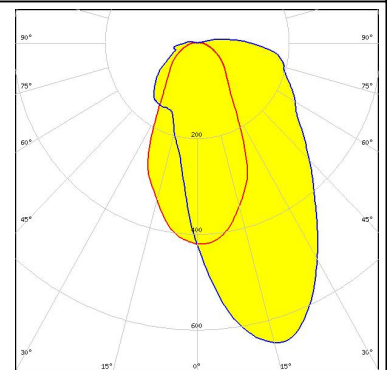

#### PHILIPS

LED Fortimo SLM L13 + SLM holder  
 FWHM Asymmetric  
 Efficiency 83 %  
 Peak intensity 0.6 cd/lm  
 LEDs/each optic 1  
 Light colour White  
 Required components:  
 TE: OPTIC CLIP Z50 TYPE1 2213194-1

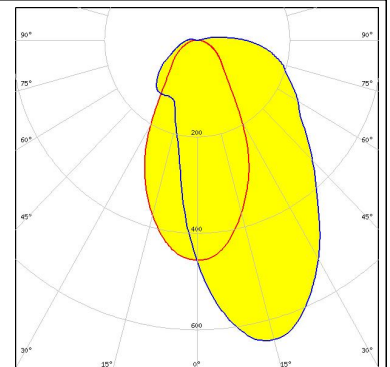
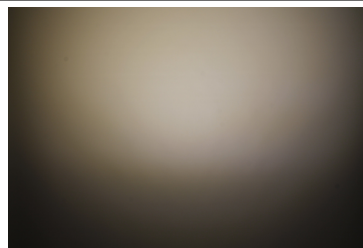

#### PHILIPS

LED Fortimo SLM L13 CoB  
 FWHM Asymmetric  
 Efficiency 85 %  
 Peak intensity 0.7 cd/lm  
 LEDs/each optic 1  
 Light colour White  
 Required components:  
 TE: 2213130-2 + OPTIC CLIP Z50 TYPE1 2213194-1

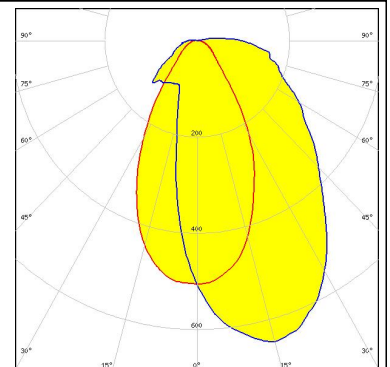
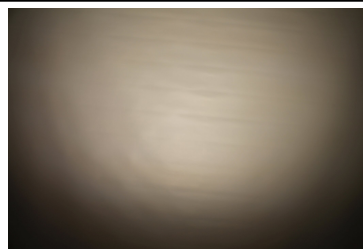

#### PHOTOMETRIC DATA (MEASURED):

#### PHILIPS

LED Fortimo SLM L15 + SLM holder  
 FWHM Asymmetric  
 Efficiency 82 %  
 Peak intensity 0.5 cd/lm  
 LEDs/each optic 1  
 Light colour White  
 Required components:  
 TE: OPTIC CLIP Z50 TYPE1 2213194-1

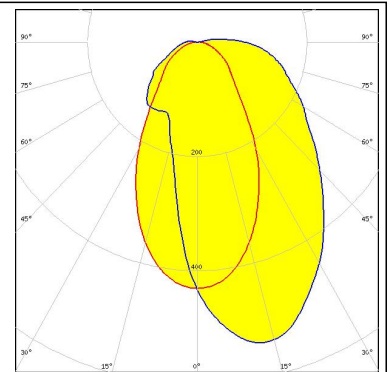
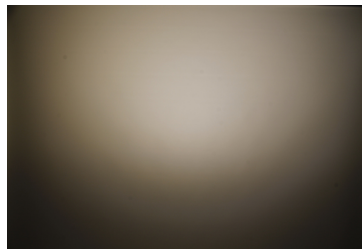

#### SAMSUNG

LED LC040C  
 FWHM Asymmetric  
 Efficiency 88 %  
 Peak intensity 0.8 cd/lm  
 LEDs/each optic 1  
 Light colour White  
 Required components:  
 TE: 2213382-2 + OPTIC CLIP Z50 TYPE1 2213194-1

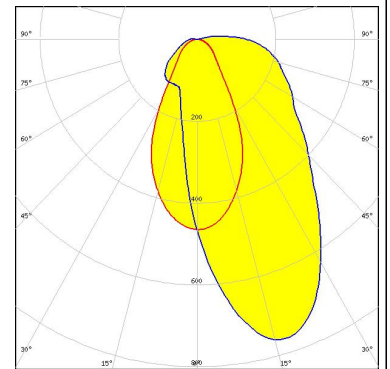
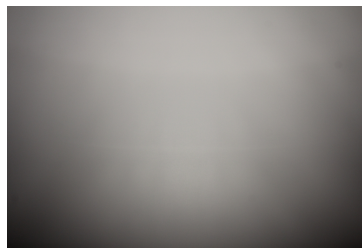

SEOUL SEMICONDUCTOR  
 LED AC Zhaga COB  
 FWHM Asymmetric  
 Efficiency 86 %  
 Peak intensity 0.6 cd/lm  
 LEDs/each optic 1  
 Light colour White  
 Required components:  
 Optosource: SEHSMJD-A

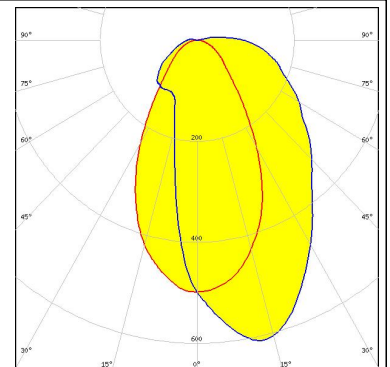
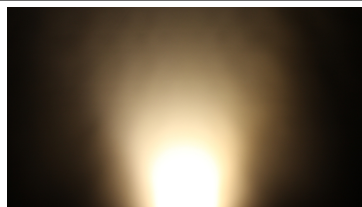

SEOUL SEMICONDUCTOR  
 LED MJT COB LES 14.5  
 FWHM Asymmetric  
 Efficiency 82 %  
 Peak intensity 0.5 cd/lm  
 LEDs/each optic 1  
 Light colour White  
 Required components:  
 TE: 2213254-2 + OPTIC CLIP Z50 TYPE1 2213194-1

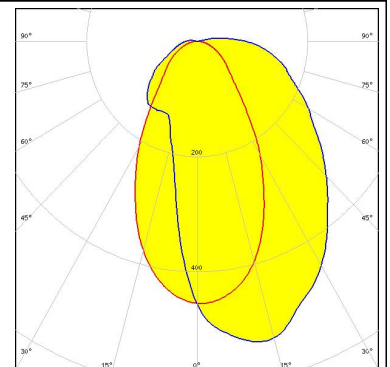
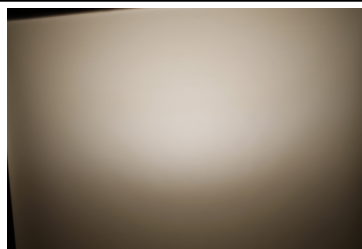



## PHOTOMETRIC DATA (MEASURED):



LED WU-M-484  
FWHM Asymmetric  
Efficiency 84 %  
Peak intensity 0.6 cd/lm  
LEDs/each optic 1  
Light colour White  
Required components:  
TE: OPTIC CLIP Z50 TYPE1 2213194-1

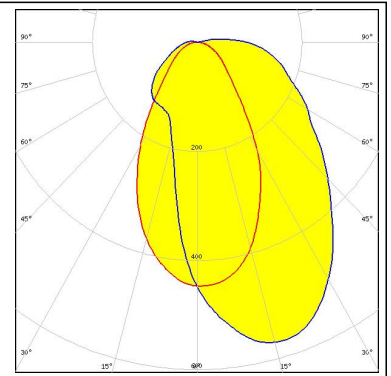

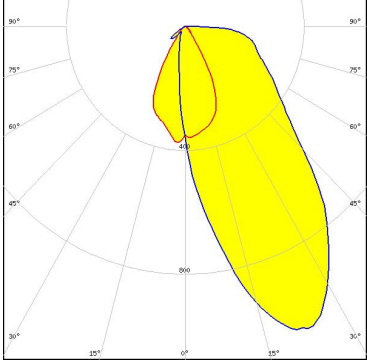
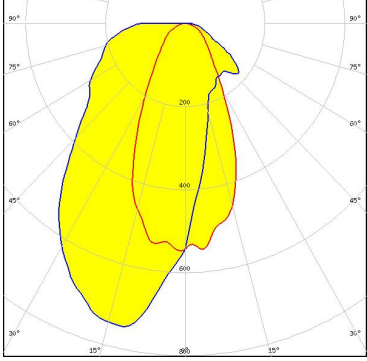
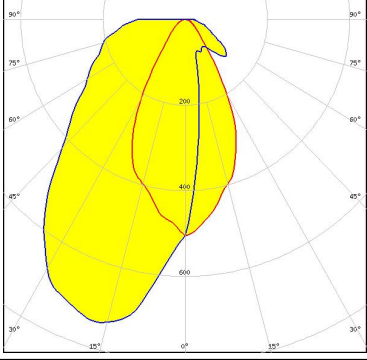
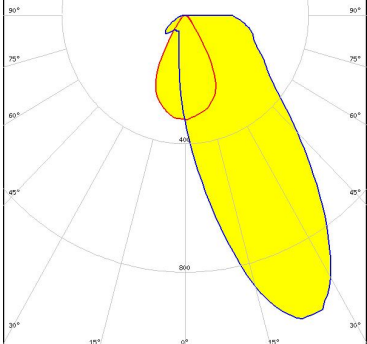

#### PHOTOMETRIC DATA (SIMULATED):

<p>bridgelux.</p> <p>LED V10 Gen6            FWHM Asymmetric            Efficiency 84 %            Peak intensity 1.1 cd/lm            LEDs/each optic 1            Light colour White            Required components:            C14123_CLAMP-CXA15-18</p>	
<p>bridgelux.</p> <p>LED V13 Gen7            FWHM Asymmetric            Efficiency 89 %            Peak intensity 0.8 cd/lm            LEDs/each optic 1            Light colour White            Required components:            IDEAL: 50-2103CT + 50-2100AN</p>	
<p>bridgelux.</p> <p>LED V13 Gen7            FWHM Asymmetric            Efficiency 84 %            Peak intensity 0.7 cd/lm            LEDs/each optic 1            Light colour White            Required components:            C13658_CLAMP-VERO13-18            Bender Wirth: 477 Typ L1</p>	
<p><b>CITIZEN</b></p> <p>LED CLL02x/CLU02x (LES10)            FWHM Asymmetric            Efficiency 86 %            Peak intensity 1 cd/lm            LEDs/each optic 1            Light colour White            Required components:            C13658_CLAMP-VERO13-18            Bender Wirth: 434 Typ L1</p>	

#### PHOTOMETRIC DATA (SIMULATED):

#### CITIZEN

LED CLU700/701/702  
FWHM Asymmetric  
Efficiency 86 %  
Peak intensity 1.2 cd/lm  
LEDs/each optic 1  
Light colour White  
Required components:  
C13658\_CLAMP-VERO13-18  
Bender Wirth: 434 Typ L1

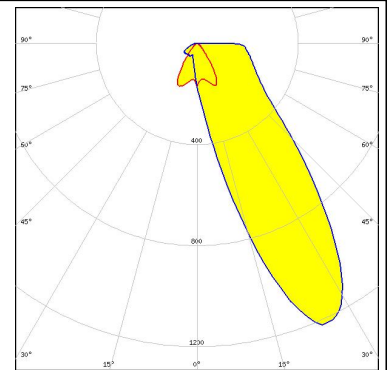

#### CITIZEN

LED CLU710/711  
FWHM Asymmetric  
Efficiency 86 %  
Peak intensity 1.1 cd/lm  
LEDs/each optic 1  
Light colour White  
Required components:  
C13658\_CLAMP-VERO13-18  
Bender Wirth: 470 Typ L1

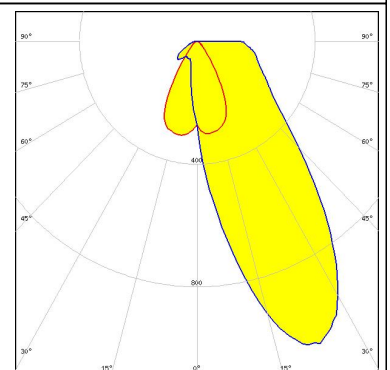

#### CREE

LED CXA/B 13xx  
FWHM Asymmetric  
Efficiency 87 %  
Peak intensity 1.2 cd/lm  
LEDs/each optic 1  
Light colour White  
Required components:  
C13658\_CLAMP-VERO13-18  
Bender Wirth: 448 Typ L1

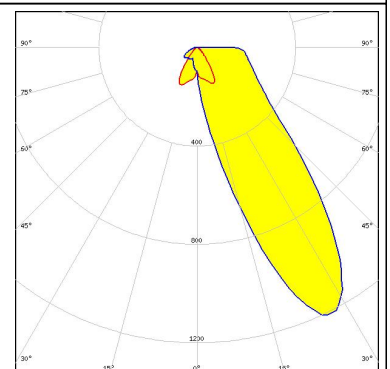

#### CREE

LED CXA/B 15xx  
FWHM Asymmetric  
Efficiency 86 %  
Peak intensity 1.1 cd/lm  
LEDs/each optic 1  
Light colour White  
Required components:  
C13658\_CLAMP-VERO13-18  
Bender Wirth: 441 Typ L1

#### PHOTOMETRIC DATA (SIMULATED):

#### CREE

LED CXA/B 1816 & CXA/B 1820 & CXA 1850  
 FWHM Asymmetric  
 Efficiency 86 %  
 Peak intensity 1 cd/lm  
 LEDs/each optic 1  
 Light colour White  
 Required components:  
 C13658\_CLAMP-VERO13-18  
 Bender Wirth: 437 Typ L1

#### CREE

LED CXA/B 1816 & CXA/B 1820 & CXA 1850  
 FWHM Asymmetric  
 Efficiency 86 %  
 Peak intensity 0.9 cd/lm  
 LEDs/each optic 1  
 Light colour White  
 Required components:  
 C14123\_CLAMP-CXA15-18

#### CREE

LED CXA/B 1816 & CXA/B 1820 & CXA 1850  
 FWHM Asymmetric  
 Efficiency 86 %  
 Peak intensity 1 cd/lm  
 LEDs/each optic 1  
 Light colour White  
 Required components:  
 TE: 2213401-2 + OPTIC CLIP Z50 TYPE1 2213194-1

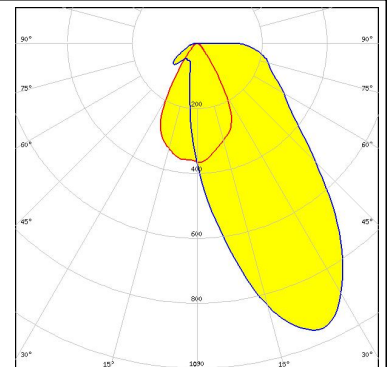

#### CREE

LED CXA/B 1830  
 FWHM Asymmetric  
 Efficiency 85 %  
 Peak intensity 0.9 cd/lm  
 LEDs/each optic 1  
 Light colour White  
 Required components:  
 C14123\_CLAMP-CXA15-18

#### PHOTOMETRIC DATA (SIMULATED):

#### LUMILEDS

LED LUXEON CoB 1202/1203  
FWHM Asymmetric  
Efficiency 85 %  
Peak intensity 1 cd/lm  
LEDs/each optic 1  
Light colour White  
Required components:  
TE: 2213382-2 + OPTIC CLIP Z50 TYPE1 2213194-1

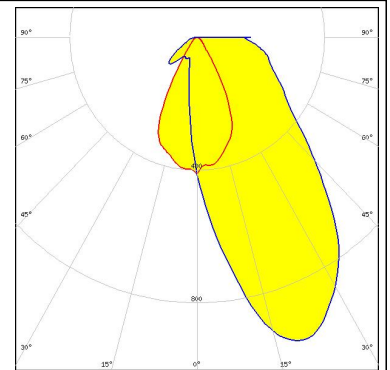

#### LUMILEDS

LED LUXEON CoB 1202s  
FWHM Asymmetric  
Efficiency 86 %  
Peak intensity 1.2 cd/lm  
LEDs/each optic 1  
Light colour White  
Required components:  
C13658\_CLAMP-VERO13-18  
Bender Wirth: 452 Typ L1

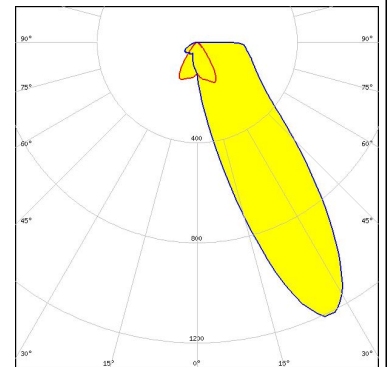

#### NICHIA

LED COB L-Type (LES 9)  
FWHM Asymmetric  
Efficiency 85 %  
Peak intensity 1.1 cd/lm  
LEDs/each optic 1  
Light colour White  
Required components:  
TE: 2213382-2 + OPTIC CLIP Z50 TYPE1 2213194-1

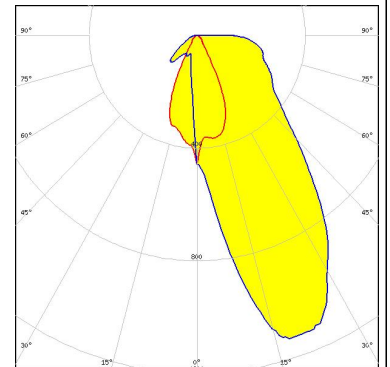

#### NICHIA

LED NSCxL036A  
FWHM Asymmetric  
Efficiency 86 %  
Peak intensity 1.2 cd/lm  
LEDs/each optic 1  
Light colour White  
Required components:  
TE: 2213382-2 + OPTIC CLIP Z50 TYPE1 2213194-1

#### PHOTOMETRIC DATA (SIMULATED):

#### OSRAM

Opto Semiconductors

LED Duris S10  
FWHM Asymmetric  
Efficiency 86 %  
Peak intensity 1.1 cd/lm  
LEDs/each optic 1  
Light colour White  
Required components:  
C13658\_CLAMP-VERO13-18

#### OSRAM

Opto Semiconductors

LED Soleriq S13  
FWHM Asymmetric  
Efficiency 82 %  
Peak intensity 0.8 cd/lm  
LEDs/each optic 1  
Light colour White  
Required components:  
C14123\_CLAMP-CXA15-18

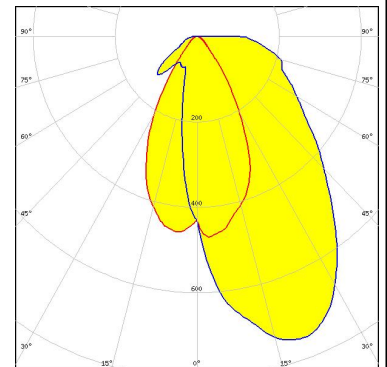

#### OSRAM

Opto Semiconductors

LED Soleriq S9  
FWHM Asymmetric  
Efficiency 86 %  
Peak intensity 0.9 cd/lm  
LEDs/each optic 1  
Light colour White  
Required components:  
C13658\_CLAMP-VERO13-18  
Bender Wirth: 434 Typ L1

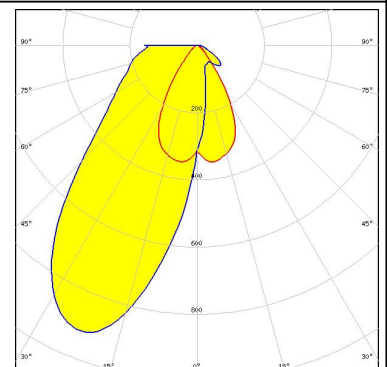

#### SHARP

LED Mini Zenigata (GW6BM)  
FWHM Asymmetric  
Efficiency 85 %  
Peak intensity 1.1 cd/lm  
LEDs/each optic 1  
Light colour White  
Required components:  
C13658\_CLAMP-VERO13-18  
Bender Wirth: 452 Typ L1

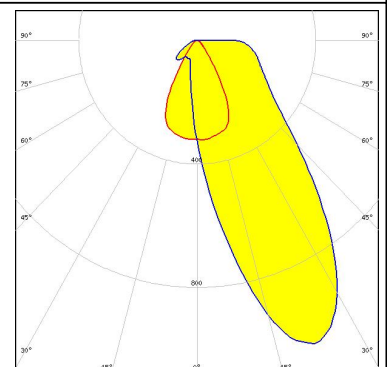

#### GENERAL INFORMATION:

NOTE: The typical beam angle will be changed by different color, chip size and chip position tolerance. The typical total beam angle is the full angle measured where the luminous intensity is half of the peak value.

Due to use of high power COB's with this product, special attention to proper thermal design is highly recommended. LEDiL has no liability for direct, indirect or consecutive damages arising from the LEDiL products being used outside of the recommended temperature range.

#### MATERIALS:

As part of our continuous research and improvement processes, and to ensure the best possible quality and availability of our products, LEDiL reserves the right to change material grades without notice.

#### PRODUCT DATA USER AGREEMENT AND DISCLAIMER:

The measured data in the provided downloadable LEDiL Product Datasheets and Mechanical 2D-Drawings is rounded and provided as reference for planning. LEDiL Oy's optical specifications have been verified by conducting performance testing of the products in accordance with the company's quality system. The reported data are averaged results of multiple measurements with typical variation. LEDiL Oy reserves the right to without prior notification make changes and improvements to its products.

LEDiL Oy assumes neither warranty, nor guarantee nor any other liability of any kind for the contents and correctness of the provided data. The provided data has been generated with highest diligence but the provided data may in reality not represent the complete possible variation range of all intrinsic parameters. Therefore, in certain cases a deviation from the provided data could occur.

LEDiL Oy reserves the right to undertake technical changes of its products without further notification which could lead to changes in the provided data. LEDiL Oy assumes no liability of any kind for the possible deviation from any provided data or any other damage resulting from the usage of the provided data.

The user agrees to this disclaimer and user agreement with the download or usage of the provided files.

#### LEDiL Oy

Joensuunkatu 13  
FI-24240 SALO  
Finland

#### LEDiL Inc.

228 West Page Street  
Suite D  
Sycamore IL 60178  
USA

#### Local sales and technical support

[www.ledil.com/where\\_to\\_buy](http://www.ledil.com/where_to_buy)

#### Shipping locations

Salo, Finland  
Hong Kong, China

#### Distribution Partners

[www.ledil.com/where\\_to\\_buy](http://www.ledil.com/where_to_buy)



Компания «Life Electronics» занимается поставками электронных компонентов импортного и отечественного производства от производителей и со складов крупных дистрибьюторов Европы, Америки и Азии.

С конца 2013 года компания активно расширяет линейку поставок компонентов по направлению коаксиальный кабель, кварцевые генераторы и конденсаторы (керамические, пленочные, электролитические), за счёт заключения дистрибьюторских договоров

Мы предлагаем:

- Конкурентоспособные цены и скидки постоянным клиентам.
- Специальные условия для постоянных клиентов.
- Подбор аналогов.
- Поставку компонентов в любых объемах, удовлетворяющих вашим потребностям.
- Приемлемые сроки поставки, возможна ускоренная поставка.
- Доставку товара в любую точку России и стран СНГ.
- Комплексную поставку.
- Работу по проектам и поставку образцов.
- Формирование склада под заказчика.
- Сертификаты соответствия на поставляемую продукцию (по желанию клиента).
- Тестирование поставляемой продукции.
- Поставку компонентов, требующих военную и космическую приемку.
- Входной контроль качества.
- Наличие сертификата ISO.

В составе нашей компании организован Конструкторский отдел, призванный помогать разработчикам, и инженерам.

Конструкторский отдел помогает осуществить:

- Регистрацию проекта у производителя компонентов.
- Техническую поддержку проекта.
- Защиту от снятия компонента с производства.
- Оценку стоимости проекта по компонентам.
- Изготовление тестовой платы монтаж и пусконаладочные работы.



Тел: +7 (812) 336 43 04 (многоканальный)  
Email: [org@lifeelectronics.ru](mailto:org@lifeelectronics.ru)