

FEATURES

- 12MHz Gain Bandwidth
- 400V/ μ s Slew Rate
- 1.25mA Maximum Supply Current per Amplifier
- Unity-Gain Stable
- C-Load™ Op Amp Drives All Capacitive Loads
- 10nV/ $\sqrt{\text{Hz}}$ Input Noise Voltage
- 800 μ V Maximum Input Offset Voltage
- 300nA Maximum Input Bias Current
- 70nA Maximum Input Offset Current
- 12V/mV Minimum DC Gain, $R_L = 1\text{k}$
- 230ns Settling Time to 0.1%, 10V Step
- 280ns Settling Time to 0.01%, 10V Step
- $\pm 12\text{V}$ Minimum Output Swing into 500 Ω
- $\pm 2.75\text{V}$ Minimum Output Swing into 150 Ω
- Specified at $\pm 2.5\text{V}$, $\pm 5\text{V}$, and $\pm 15\text{V}$

APPLICATIONS

- Wideband Amplifiers
- Buffers
- Active Filters
- Data Acquisition Systems
- Photodiode Amplifiers

DESCRIPTION

The LT[®]1355/LT1356 are dual and quad low power high speed operational amplifiers with outstanding AC and DC performance. The amplifiers feature much lower supply current and higher slew rate than devices with comparable bandwidth. The circuit topology is a voltage feedback amplifier with matched high impedance inputs and the slewing performance of a current feedback amplifier. The high slew rate and single stage design provide excellent settling characteristics which make the circuit an ideal choice for data acquisition systems. Each output drives a 500 Ω load to $\pm 12\text{V}$ with $\pm 15\text{V}$ supplies and a 150 Ω load to $\pm 2.75\text{V}$ on $\pm 5\text{V}$ supplies. The amplifiers are stable with any capacitive load making them useful in buffer applications.

The LT1355/LT1356 are members of a family of fast, high performance amplifiers using this unique topology and employing Linear Technology Corporation's advanced bipolar complementary processing. For a single amplifier version of the LT1355/LT1356 see the LT1354 data sheet. For higher bandwidth devices with higher supply currents see the LT1357 through LT1365 data sheets. Bandwidths of 25MHz, 50MHz, and 70MHz are available with 2mA, 4mA, and 6mA of supply current per amplifier. Singles, duals, and quads of each amplifier are available.

LT, LT, LTC, LTM, Linear Technology and the Linear logo are registered trademarks of Linear Technology Corporation. C-Load is a trademark of Linear Technology Corporation. All other trademarks are the property of their respective owners.

TYPICAL APPLICATION

100kHz, 4th Order Butterworth Filter

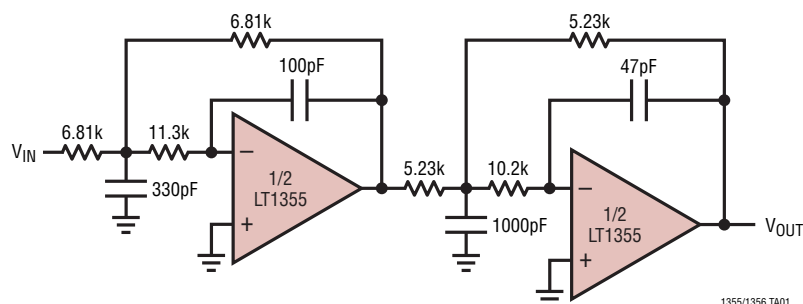

1355/1356 TA01

$A_V = -1$ Large-Signal Response

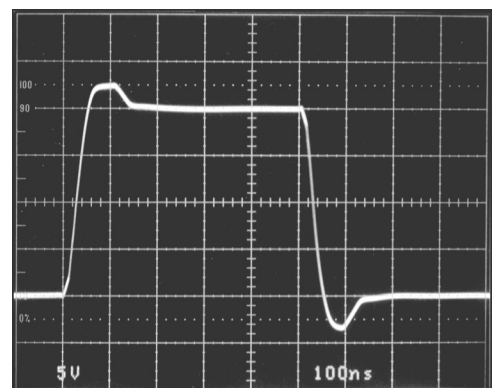

13556 TA01B

13556fc

LT1355/LT1356

ABSOLUTE MAXIMUM RATINGS (Note 1)

| | |
|--|--|
| Total Supply Voltage (V^+ to V^-)..... | 36V |
| Differential Input Voltage (Transient Only) (Note 2)..... | $\pm 10V$ |
| Input Voltage..... | $\pm V_S$ |
| Output Short-Circuit Duration (Note 3) | Indefinite |
| Operating Temperature Range (Note 7) LT1355C/LT1356C/LT1356I..... | -40°C to 85°C |
| LT1356H (T_C)..... | -40°C to 125°C |

| | |
|---|--|
| Specified Temperature Range (Note 8) LT1355C/LT1356C | 0°C to 70°C |
| LT1356I..... | -40°C to 85°C |
| LT1356H (T_C)..... | -40°C to 125°C |
| Maximum Junction Temperature | 150°C |
| Storage Temperature Range | -65°C to 150°C |
| Lead Temperature (Soldering, 10 sec)..... | 300°C |

PIN CONFIGURATION

| | |
|---|--|
| <p>LT1355</p> <p>N8 PACKAGE 8-LEAD PDIP $T_{JMAX} = 150^\circ\text{C}$, $\theta_{JA} = 130^\circ\text{C/W}$</p> | <p>LT1355</p> <p>S8 PACKAGE 8-LEAD PLASTIC SO $T_{JMAX} = 150^\circ\text{C}$, $\theta_{JA} = 190^\circ\text{C/W}$</p> |
| <p>LT1356</p> <p>N PACKAGE 14-LEAD PDIP $T_{JMAX} = 150^\circ\text{C}$, $\theta_{JA} = 110^\circ\text{C/W}$</p> | <p>LT1356</p> <p>S PACKAGE 16-LEAD PLASTIC SO $T_{JMAX} = 150^\circ\text{C}$, $\theta_{JA} = 150^\circ\text{C/W}$, $\theta_{JC} = 30^\circ\text{C/W}$</p> |

ORDER INFORMATION

| LEAD FREE FINISH | TAPE AND REEL | PART MARKING | PACKAGE DESCRIPTION | SPECIFIED TEMPERATURE RANGE |
|------------------|-----------------|--------------|---------------------|---|
| LT1355CN8#PBF | LT1355CN8#TRPBF | LT1355CN8 | 8-Lead PDIP | 0°C to 70°C |
| LT1355CS8#PBF | LT1355CS8#TRPBF | 1355 | 8-Lead Plastic SO | 0°C to 70°C |
| LT1356CN#PBF | LT1356CN#TRPBF | LT1356CN | 14-Lead PDIP | 0°C to 70°C |
| LT1356CS#PBF | LT1356CS#TRPBF | LT1356CS | 16-Lead Plastic SO | 0°C to 70°C |
| LT1356IS#PBF | LT1356IS#TRPBF | LT1356S | 16-Lead Plastic SO | -40°C to 85°C |
| LT1356HS#PBF | LT1356HS#TRPBF | LT1356S | 16-Lead Plastic SO | $-40^\circ\text{C} < T_C < 125^\circ\text{C}$ |

Consult LTC Marketing for parts specified with wider operating temperature ranges.

Consult LTC Marketing for information on non-standard lead based finish parts.

For more information on lead free part marking, go to: <http://www.linear.com/leadfree/>

For more information on tape and reel specifications, go to: <http://www.linear.com/tapeandreeel/>

13556fc

ELECTRICAL CHARACTERISTICS $T_A = 25^\circ\text{C}$, $V_{CM} = 0\text{V}$ unless otherwise noted.

| SYMBOL | PARAMETER | CONDITIONS | V_{SUPPLY} | MIN | TYP | MAX | UNITS |
|---------------|----------------------------------|--|---|-------------------|-------|-----|------------------------------|
| V_{OS} | Input Offset Voltage | | $\pm 15\text{V}$ | 0.3 | 0.8 | | mV |
| | | | $\pm 5\text{V}$ | 0.3 | 0.8 | | mV |
| | | | $\pm 2.5\text{V}$ | 0.4 | 1.0 | | mV |
| I_{OS} | Input Offset Current | | $\pm 2.5\text{V}$ to $\pm 15\text{V}$ | 20 | 70 | | nA |
| I_B | Input Bias Current | | $\pm 2.5\text{V}$ to $\pm 15\text{V}$ | 80 | 300 | | nA |
| e_n | Input Noise Voltage | $f = 10\text{kHz}$ | $\pm 2.5\text{V}$ to $\pm 15\text{V}$ | | 10 | | $\text{nV}/\sqrt{\text{Hz}}$ |
| i_n | Input Noise Current | $f = 10\text{kHz}$ | $\pm 2.5\text{V}$ to $\pm 15\text{V}$ | | 0.6 | | $\text{pA}/\sqrt{\text{Hz}}$ |
| R_{IN} | Input Resistance | $V_{CM} = \pm 12\text{V}$ | $\pm 15\text{V}$ | 70 | 160 | | $\text{M}\Omega$ |
| | Input Resistance | Differential | $\pm 15\text{V}$ | | 11 | | $\text{M}\Omega$ |
| C_{IN} | Input Capacitance | | $\pm 15\text{V}$ | | 3 | | pF |
| | Input Voltage Range ⁺ | | $\pm 15\text{V}$ | 12.0 | 13.4 | | V |
| | | | $\pm 5\text{V}$ | 2.5 | 3.5 | | V |
| | | | $\pm 2.5\text{V}$ | 0.5 | 1.1 | | V |
| | Input Voltage Range ⁻ | | $\pm 15\text{V}$ | -13.2 | -12.0 | | V |
| | | | $\pm 5\text{V}$ | -3.4 | -2.5 | | V |
| | | | $\pm 2.5\text{V}$ | -0.9 | -0.5 | | V |
| CMRR | Common Mode Rejection Ratio | $V_{CM} = \pm 12\text{V}$ $V_{CM} = \pm 2.5\text{V}$ $V_{CM} = \pm 0.5\text{V}$ | $\pm 15\text{V}$ | 83 | 97 | | dB |
| | | | $\pm 5\text{V}$ | 78 | 84 | | dB |
| | | | $\pm 2.5\text{V}$ | 68 | 75 | | dB |
| PSRR | Power Supply Rejection Ratio | $V_S = \pm 2.5\text{V}$ to $\pm 15\text{V}$ | | 92 | 106 | | dB |
| A_{VOL} | Large-Signal Voltage Gain | | $V_{OUT} = \pm 12\text{V}$, $R_L = 1\text{k}$ | $\pm 15\text{V}$ | 12 | 36 | V/mV |
| | | | $V_{OUT} = \pm 10\text{V}$, $R_L = 500\Omega$ | $\pm 15\text{V}$ | 5 | 15 | V/mV |
| | | | $V_{OUT} = \pm 2.5\text{V}$, $R_L = 1\text{k}$ | $\pm 5\text{V}$ | 12 | 36 | V/mV |
| | | | $V_{OUT} = \pm 2.5\text{V}$, $R_L = 500\Omega$ | $\pm 5\text{V}$ | 5 | 15 | V/mV |
| | | | $V_{OUT} = \pm 2.5\text{V}$, $R_L = 150\Omega$ | $\pm 5\text{V}$ | 1 | 4 | V/mV |
| | | | $V_{OUT} = \pm 1\text{V}$, $R_L = 500\Omega$ | $\pm 2.5\text{V}$ | 5 | 20 | V/mV |
| V_{OUT} | Output Swing | $R_L = 1\text{k}$, $V_{IN} = \pm 40\text{mV}$ $R_L = 500\Omega$, $V_{IN} = \pm 40\text{mV}$ $R_L = 500\Omega$, $V_{IN} = \pm 40\text{mV}$ $R_L = 150\Omega$, $V_{IN} = \pm 40\text{mV}$ $R_L = 500\Omega$, $V_{IN} = \pm 40\text{mV}$ | $\pm 15\text{V}$ | 13.3 | 13.8 | | $\pm \text{V}$ |
| | | | $\pm 15\text{V}$ | 12.0 | 13.0 | | $\pm \text{V}$ |
| | | | $\pm 5\text{V}$ | 3.5 | 4.0 | | $\pm \text{V}$ |
| | | | $\pm 5\text{V}$ | 2.75 | 3.3 | | $\pm \text{V}$ |
| | | | $\pm 5\text{V}$ | 1.3 | 1.7 | | $\pm \text{V}$ |
| | | | $\pm 2.5\text{V}$ | | | | $\pm \text{V}$ |
| I_{OUT} | Output Current | | $V_{OUT} = \pm 12.0\text{V}$ | $\pm 15\text{V}$ | 24.0 | 30 | mA |
| | | | $V_{OUT} = \pm 2.75\text{V}$ | $\pm 5\text{V}$ | 18.3 | 25 | mA |
| I_{SC} | Short-Circuit Current | $V_{OUT} = 0\text{V}$, $V_{IN} = \pm 3\text{V}$ | $\pm 15\text{V}$ | 30 | 42 | | mA |
| SR | Slew Rate | $A_V = -2$ (Note 4) | $\pm 15\text{V}$ | 200 | 400 | | $\text{V}/\mu\text{s}$ |
| | | | $\pm 5\text{V}$ | 70 | 120 | | $\text{V}/\mu\text{s}$ |
| | Full-Power Bandwidth | 10V Peak (Note 5) 3V Peak (Note 5) | $\pm 15\text{V}$ | | 6.4 | | MHz |
| | | | $\pm 5\text{V}$ | | 6.4 | | MHz |
| GBW | Gain Bandwidth | $f = 200\text{kHz}$, $R_L = 2\text{k}$ | $\pm 15\text{V}$ | 9.0 | 12.0 | | MHz |
| | | | $\pm 5\text{V}$ | 7.5 | 10.5 | | MHz |
| | | | $\pm 2.5\text{V}$ | | 9.0 | | MHz |
| t_r , t_f | Rise Time, Fall Time | $A_V = 1$, 10% to 90%, 0.1V | $\pm 15\text{V}$ | | 14 | | ns |
| | | | $\pm 5\text{V}$ | | 17 | | ns |
| | Overshoot | $A_V = 1$, 0.1V | $\pm 15\text{V}$ | | 20 | | % |
| | | | $\pm 5\text{V}$ | | 18 | | % |
| | Propagation Delay | 50% V_{IN} to 50% V_{OUT} , 0.1V | $\pm 15\text{V}$ | | 16 | | ns |
| | | | $\pm 5\text{V}$ | | 19 | | ns |
| t_s | Settling Time | 10V Step, 0.1%, $A_V = -1$ 10V Step, 0.01%, $A_V = -1$ 5V Step, 0.1%, $A_V = -1$ 5V Step, 0.01%, $A_V = -1$ | $\pm 15\text{V}$ | | 230 | | ns |
| | | | $\pm 15\text{V}$ | | 280 | | ns |
| | | | $\pm 5\text{V}$ | | 240 | | ns |
| | | | $\pm 5\text{V}$ | | 380 | | ns |

ELECTRICAL CHARACTERISTICS $T_A = 25^\circ\text{C}$, $V_{CM} = 0\text{V}$ unless otherwise noted.

| SYMBOL | PARAMETER | CONDITIONS | V_{SUPPLY} | MIN | TYP | MAX | UNITS |
|--------|--------------------|--|-------------------------------------|-----|------------|--------------|------------|
| | Differential Gain | $f = 3.58\text{MHz}$, $A_V = 2$, $R_L = 1\text{k}$ | $\pm 15\text{V}$ $\pm 5\text{V}$ | | 2.2 2.1 | | % % |
| | Differential Phase | $f = 3.58\text{MHz}$, $A_V = 2$, $R_L = 1\text{k}$ | $\pm 15\text{V}$ $\pm 5\text{V}$ | | 3.1 3.1 | | Deg Deg |
| R_O | Output Resistance | $A_V = 1$, $f = 100\text{kHz}$ | $\pm 15\text{V}$ | | 0.7 | | Ω |
| | Channel Separation | $V_{OUT} = \pm 10\text{V}$, $R_L = 500\Omega$ | $\pm 15\text{V}$ | 100 | 113 | | dB |
| I_S | Supply Current | Each Amplifier Each Amplifier | $\pm 15\text{V}$ $\pm 5\text{V}$ | | 1.0 0.9 | 1.25 1.20 | mA mA |

The ● denotes the specifications which apply over the temperature range $0^\circ\text{C} \leq T_A \leq 70^\circ\text{C}$, $V_{CM} = 0\text{V}$, unless otherwise noted.

| SYMBOL | PARAMETER | CONDITIONS | V_{SUPPLY} | MIN | TYP | MAX | UNITS |
|-----------|------------------------------|--|--|----------------------------|--|-------------------|---|
| V_{OS} | Input Offset Voltage | | $\pm 15\text{V}$ $\pm 5\text{V}$ $\pm 2.5\text{V}$ | ● ● ● | | 1.0 1.0 1.2 | mV mV mV |
| | Input V_{OS} Drift | (Note 6) | $\pm 2.5\text{V}$ to $\pm 15\text{V}$ | ● | 5 | 8 | $\mu\text{V}/^\circ\text{C}$ |
| I_{OS} | Input Offset Current | | $\pm 2.5\text{V}$ to $\pm 15\text{V}$ | ● | | 100 | nA |
| I_B | Input Bias Current | | $\pm 2.5\text{V}$ to $\pm 15\text{V}$ | ● | | 450 | nA |
| CMRR | Common Mode Rejection Ratio | $V_{CM} = \pm 12\text{V}$ $V_{CM} = \pm 2.5\text{V}$ $V_{CM} = \pm 0.5\text{V}$ | $\pm 15\text{V}$ $\pm 5\text{V}$ $\pm 2.5\text{V}$ | ● ● ● | 81 77 67 | | dB dB dB |
| PSRR | Power Supply Rejection Ratio | $V_S = \pm 2.5\text{V}$ to $\pm 15\text{V}$ | | ● | 90 | | dB |
| A_{VOL} | Large-Signal Voltage Gain | $V_{OUT} = \pm 12\text{V}$, $R_L = 1\text{k}$ $V_{OUT} = \pm 10\text{V}$, $R_L = 500\Omega$ $V_{OUT} = \pm 2.5\text{V}$, $R_L = 1\text{k}$ $V_{OUT} = \pm 2.5\text{V}$, $R_L = 500\Omega$ $V_{OUT} = \pm 2.5\text{V}$, $R_L = 150\Omega$ $V_{OUT} = \pm 1\text{V}$, $R_L = 500\Omega$ | $\pm 15\text{V}$ $\pm 15\text{V}$ $\pm 5\text{V}$ $\pm 5\text{V}$ $\pm 5\text{V}$ $\pm 2.5\text{V}$ | ● ● ● ● ● ● | 10.0 3.3 10.0 3.3 0.6 3.3 | | V/mV V/mV V/mV V/mV V/mV V/mV |
| V_{OUT} | Output Swing | $R_L = 1\text{k}$, $V_{IN} = \pm 40\text{mV}$ $R_L = 500\Omega$, $V_{IN} = \pm 40\text{mV}$ $R_L = 500\Omega$, $V_{IN} = \pm 40\text{mV}$ $R_L = 150\Omega$, $V_{IN} = \pm 40\text{mV}$ $R_L = 500\Omega$, $V_{IN} = \pm 40\text{mV}$ | $\pm 15\text{V}$ $\pm 15\text{V}$ $\pm 5\text{V}$ $\pm 5\text{V}$ $\pm 2.5\text{V}$ | ● ● ● ● ● | 13.2 11.5 3.4 2.5 1.2 | | $\pm\text{V}$ $\pm\text{V}$ $\pm\text{V}$ $\pm\text{V}$ $\pm\text{V}$ |
| I_{OUT} | Output Current | $V_{OUT} = \pm 11.5\text{V}$ $V_{OUT} = \pm 2.5\text{V}$ | $\pm 15\text{V}$ $\pm 5\text{V}$ | ● ● | 23.0 16.7 | | mA mA |
| I_{SC} | Short-Circuit Current | $V_{OUT} = 0\text{V}$, $V_{IN} = \pm 3\text{V}$ | $\pm 15\text{V}$ | ● | 24 | | mA |
| SR | Slew Rate | $A_V = -2$, (Note 4) | $\pm 15\text{V}$ $\pm 5\text{V}$ | ● ● | 150 60 | | V/ μs V/ μs |
| GBW | Gain Bandwidth | $f = 200\text{kHz}$, $R_L = 2\text{k}$ | $\pm 15\text{V}$ $\pm 5\text{V}$ | ● ● | 7.5 6.0 | | MHz MHz |
| | Channel Separation | $V_{OUT} = \pm 10\text{V}$, $R_L = 500\Omega$ | $\pm 15\text{V}$ | ● | 98 | | dB |
| I_S | Supply Current | Each Amplifier Each Amplifier | $\pm 15\text{V}$ $\pm 5\text{V}$ | ● ● | | 1.45 1.40 | mA mA |

ELECTRICAL CHARACTERISTICS The ● denotes the specifications which apply over the $-40^{\circ}\text{C} \leq T_A \leq 85^{\circ}\text{C}$ and $-40^{\circ}\text{C} \leq T_C \leq 125^{\circ}\text{C}$ temperature ranges, $V_{CM} = 0\text{V}$ unless otherwise noted. (Note 8)

| SYMBOL | PARAMETER | CONDITIONS | V _{SUPPLY} | | MIN | TYP | MAX | UNITS | |
|------------------|------------------------------|---|---------------------|---|------|-----|------|-------|------|
| V _{OS} | Input Offset Voltage | | ±15V | ● | | | 1.8 | mV | |
| | | | ±5V | ● | | | 1.8 | mV | |
| | | | ±2.5V | ● | | | 2.0 | mV | |
| I _{OS} | Input Offset Current | | ±2.5V to ±15V | ● | | | 250 | nA | |
| I _B | Input Bias Current | | ±2.5V to ±15V | ● | | | 600 | nA | |
| CMRR | Common Mode Rejection Ratio | V _{CM} = ±12V V _{CM} = ±2.5V V _{CM} = ±0.5V | ±15V | ● | 80 | | | | dB |
| | | | ±5V | ● | 76 | | | | dB |
| | | | ±2.5V | ● | 66 | | | | dB |
| PSRR | Power Supply Rejection Ratio | V _S = ±2.5V to ±15V | | ● | 90 | | | dB | |
| A _{VOL} | Large-Signal Voltage Gain | V _{OUT} = ±12V, R _L = 1k V _{OUT} = ±2.5V, R _L = 1k V _{OUT} = ±2.5V, R _L = 500Ω V _{OUT} = ±1V, R _L = 500Ω | ±15V | ● | 6.0 | | | | V/mV |
| | | | ±5V | ● | 4.0 | | | | V/mV |
| | | | ±5V | ● | 1.7 | | | | V/mV |
| | | | ±2.5V | ● | 1.7 | | | | V/mV |
| V _{OUT} | Output Swing | R _L = 1k, V _{IN} = ±40mV R _L = 500Ω, V _{IN} = ±40mV R _L = 500Ω, V _{IN} = ±40mV | ±15V | ● | 12.7 | | | | ±V |
| | | | ±5V | ● | 3.3 | | | | ±V |
| | | | ±2.5V | ● | 1.2 | | | | ±V |
| I _{OUT} | Output Current | V _{OUT} = ±12.7V V _{OUT} = ±3.3V | ±15V | ● | 12.7 | | | | mA |
| | | | ±5V | ● | 6.6 | | | | mA |
| I _{SC} | Short-Circuit Current | V _{OUT} = 0V, V _{IN} = ±3V | ±15V | ● | 16 | | | mA | |
| SR | Slew Rate | A _V = -2, (Note 4) | ±15V | ● | 110 | | | | V/μs |
| | | | ±5V | ● | 43 | | | | V/μs |
| GBW | Gain Bandwidth | f = 200kHz, R _L = 2k | ±15V | ● | 6.0 | | | | MHz |
| | | | ±5V | ● | 4.6 | | | | MHz |
| | Channel Separation | V _{OUT} = ±10V, R _L = 500Ω | ±15V | ● | 96 | | | dB | |
| I _S | Supply Current | Each Amplifier Each Amplifier | ±15V | ● | | | 1.55 | mA | |
| | | | ±5V | ● | | | 1.50 | mA | |

Note 1: Stresses beyond those listed under Absolute Maximum Ratings may cause permanent damage to the device. Exposure to any Absolute Maximum Rating condition for extended periods may affect device reliability and lifetime.

Note 2: Differential inputs of ±10V are appropriate for transient operation only, such as during slewing. Large, sustained differential inputs will cause excessive power dissipation and may damage the part. See Input Considerations in the Applications Information section of this data sheet for more details.

Note 3: A heat sink may be required to keep the junction temperature below absolute maximum when the output is shorted indefinitely.

Note 4: Slew rate is measured between ±10V on the output with ±6V input for ±15V supplies and ±1V on the output with ±1.75V input for ±5V supplies.

Note 5: Full power bandwidth is calculated from the slew rate measurement: $FPBW = (SR)/2\pi V_p$.

Note 6: This parameter is not 100% tested.

Note 7: The LT1355C/LT1356C/LT1356I are guaranteed functional over the operating temperature range of -40°C to 85°C. The LT1356H is guaranteed functional over the operating temperature range of -40°C to 125°C case temperature (T_C).

Note 8: The LT1355C/LT1356C are guaranteed to meet specified performance from 0°C to 70°C. The LT1355C/LT1356C are designed, characterized and expected to meet specified performance from -40°C to 85°C, but are not tested or QA sampled at these temperatures. The LT1356I is guaranteed to meet specified performance from -40°C to 85°C. The LT1356H is guaranteed to meet specified performance from -40°C to 125°C case temperature (T_C). The parts are pulse tested at these temperatures. Internal warm-up drift must be taken into account separately. Care must be taken not to exceed the maximum junction temperature.

TYPICAL PERFORMANCE CHARACTERISTICS

Supply Current vs Supply Voltage and Temperature

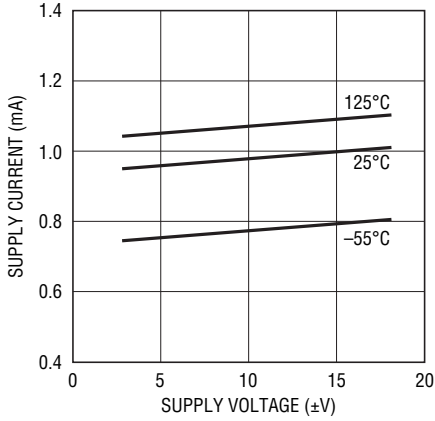

1355/1356 G01

Input Common Mode Range vs Supply Voltage

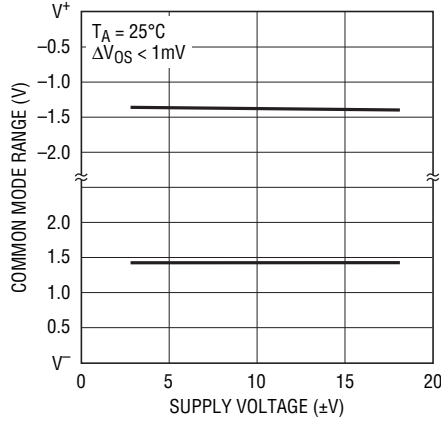

1355/1356 G02

Input Bias Current vs Input Common Mode Voltage

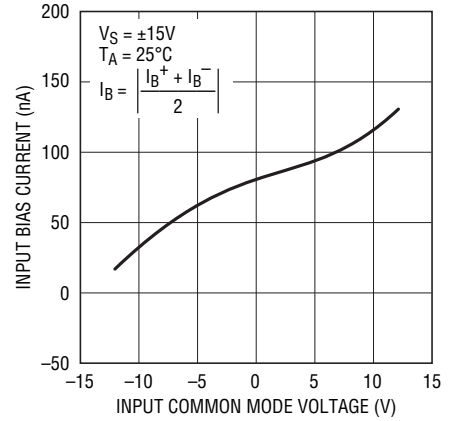

1355/1356 G03

Input Bias Current vs Temperature

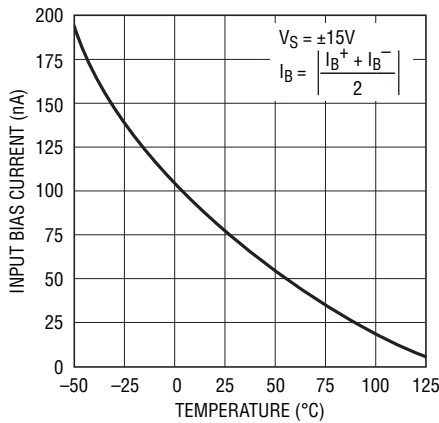

1355/1356 G04

Input Noise Spectral Density

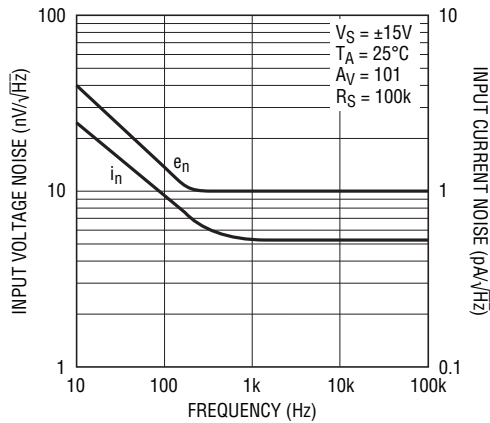

1355/1356 G05

Open-Loop Gain vs Resistive Load

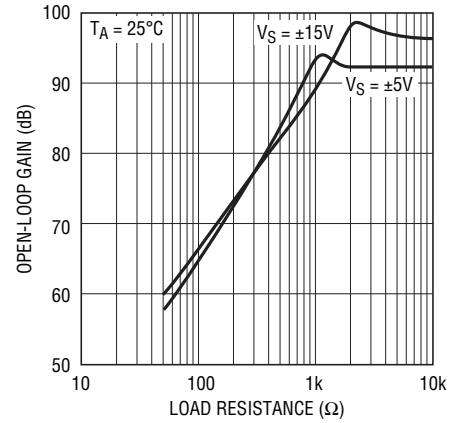

1355/1356 G06

Open-Loop Gain vs Temperature

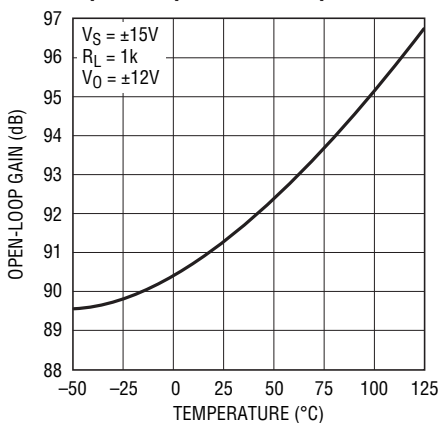

1355/1356 G07

Output Voltage Swing vs Supply Voltage

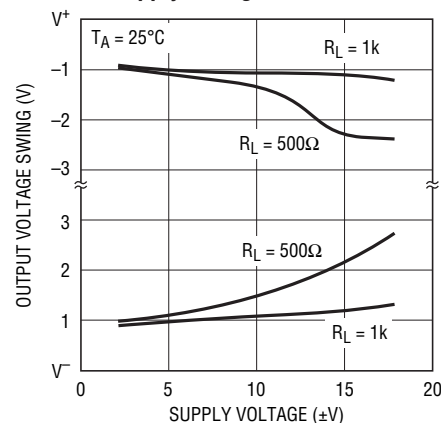

1355/1356 G08

Output Voltage Swing vs Load Current

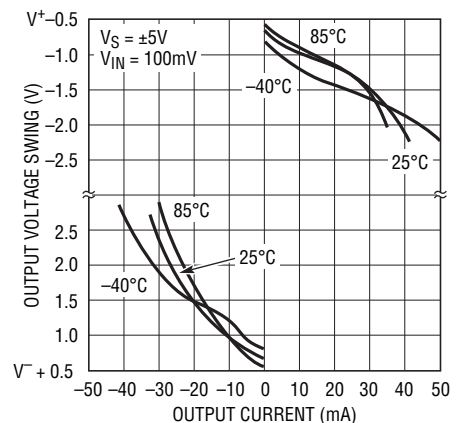

1355/1356 G09

TYPICAL PERFORMANCE CHARACTERISTICS

Output Short-Circuit Current vs Temperature

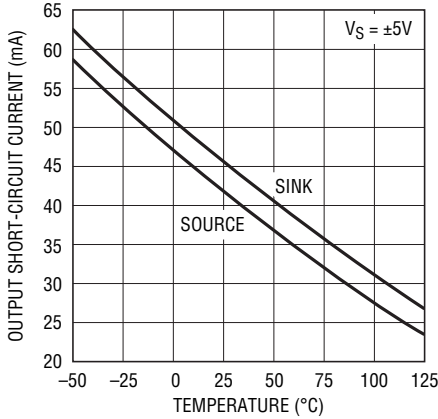

1355/1356 G10

Settling Time vs Output Step (Noninverting)

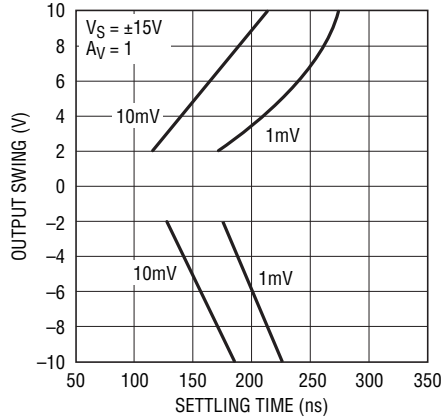

1355/1356 G11

Settling Time vs Output Step (Inverting)

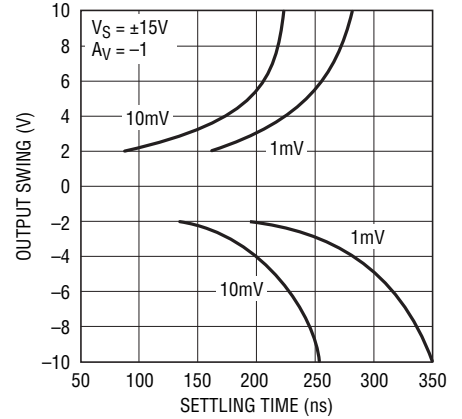

1355/1356 G12

Output Impedance vs Frequency

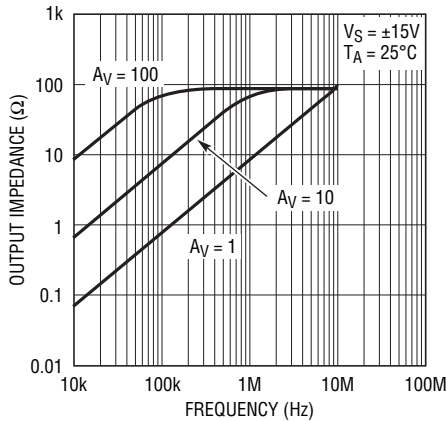

1355/1356 G13

Frequency Response vs Capacitive Load

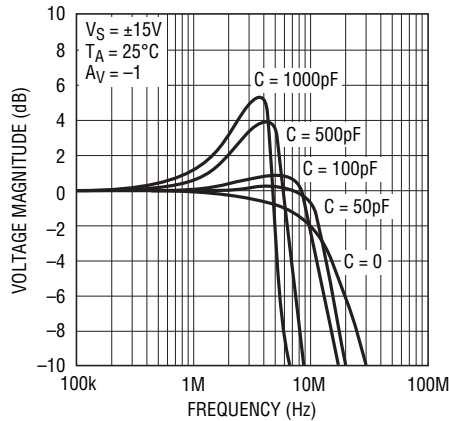

1355/1356 G19

Gain Bandwidth and Phase Margin vs Supply Voltage

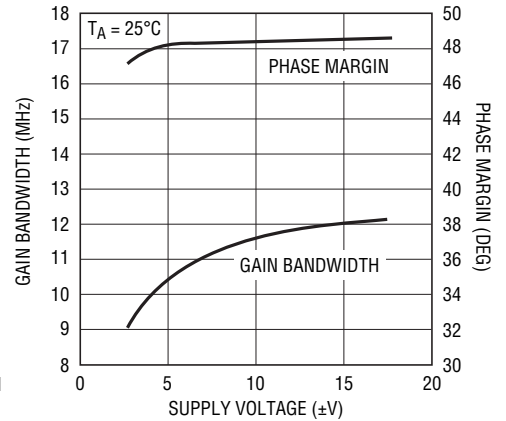

1355/1356 G15

Gain Bandwidth and Phase Margin vs Temperature

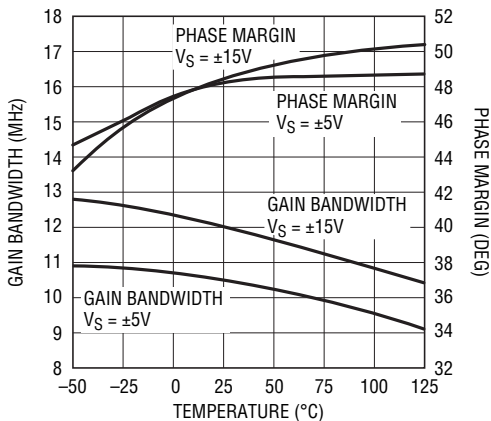

1355/1356 G16

Frequency Response vs Supply Voltage ($A_V = 1$)

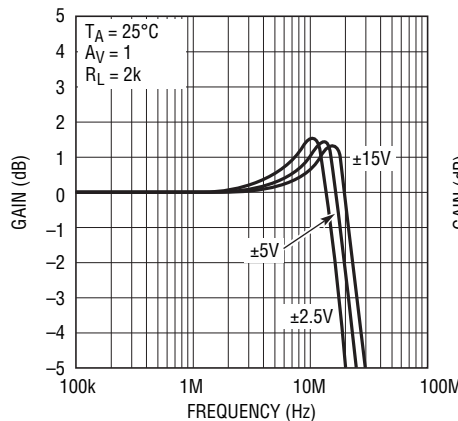

1355/1356 G17

Frequency Response vs Supply Voltage ($A_V = -1$)

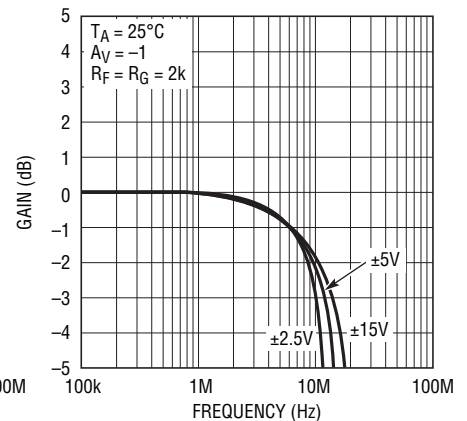

1355/1356 G18

TYPICAL PERFORMANCE CHARACTERISTICS

Gain and Phase vs Frequency

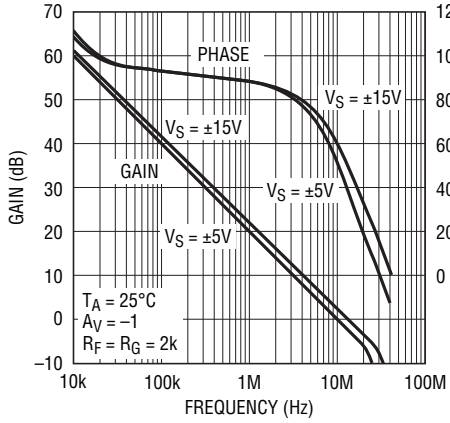

1355/1356 G14

Power Supply Rejection Ratio vs Frequency

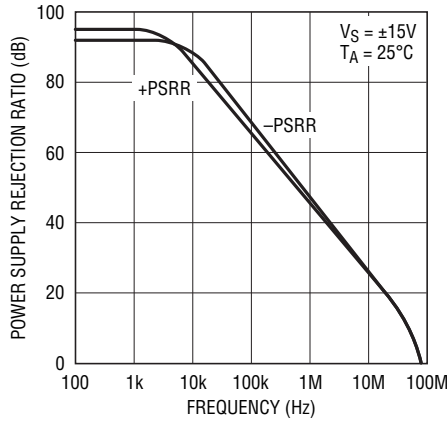

1355/1356 G20

Common Mode Rejection Ratio vs Frequency

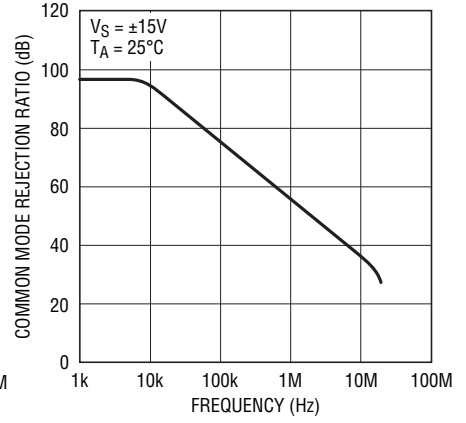

1355/1356 G21

Slew Rate vs Supply Voltage

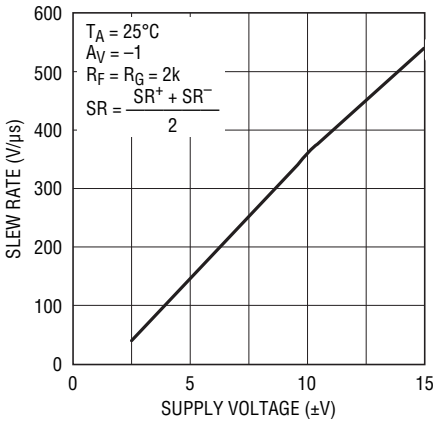

1355/1356 G22

Slew Rate vs Temperature

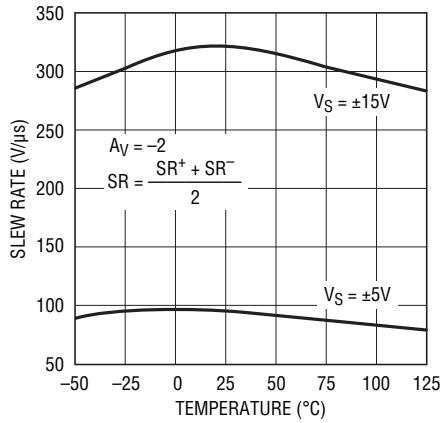

1355/1356 G23

Slew Rate vs Input Level

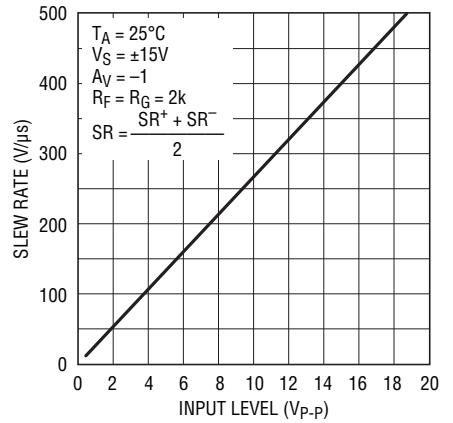

1355/1356 G24

Total Harmonic Distortion vs Frequency

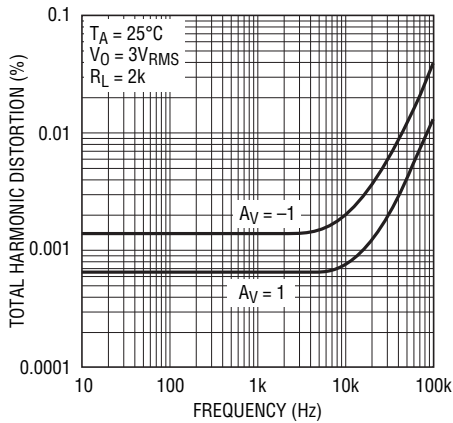

1355/1356 G25

Undistorted Output Swing vs Frequency (±15V)

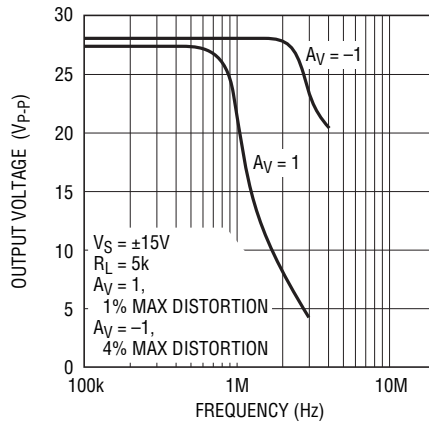

1355/1356 G26

Undistorted Output Swing vs Frequency (±5V)

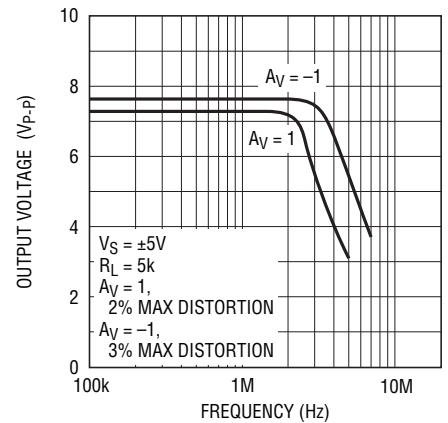

1355/1356 G27

TYPICAL PERFORMANCE CHARACTERISTICS

2nd and 3rd Harmonic Distortion vs Frequency

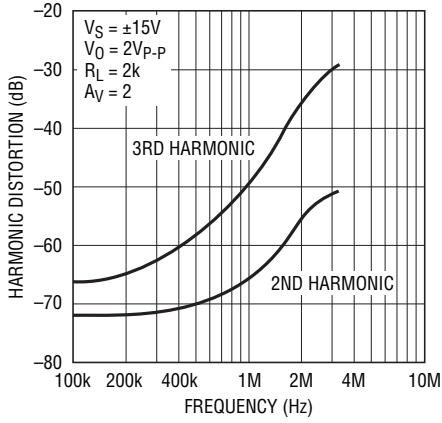

1355/1356 G28

Crosstalk vs Frequency

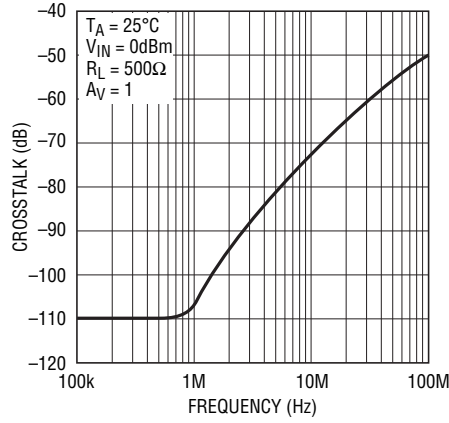

1355/1356 G29

Capacitive Load Handling

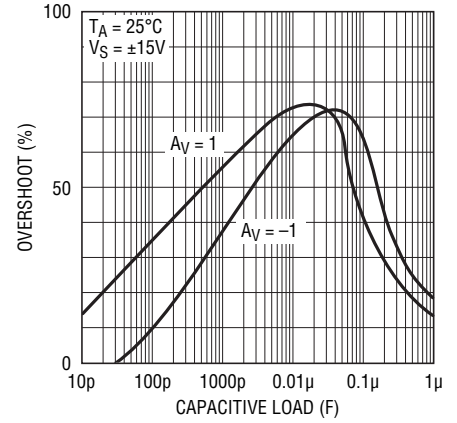

1355/1356 G30

Small-Signal Transient ($A_V = 1$)

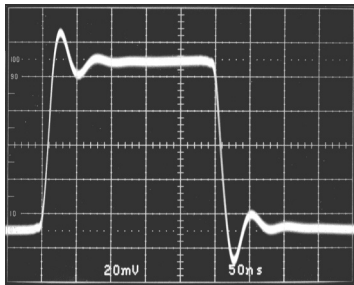

12556 G31

Small-Signal Transient ($A_V = -1$)

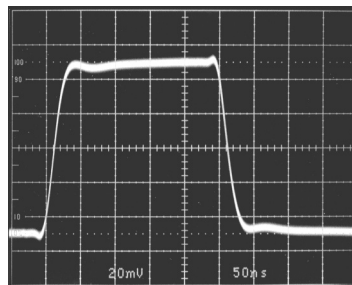

12556 G32

Small-Signal Transient ($A_V = -1, C_L = 1000pF$)

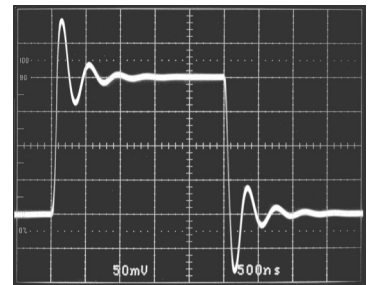

12556 G33

Large-Signal Transient ($A_V = 1$)

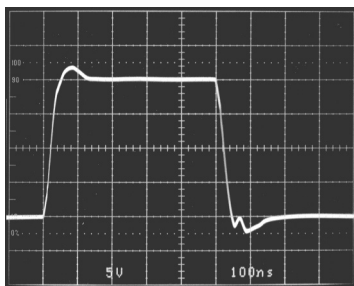

12556 G34

Large-Signal Transient ($A_V = -1$)

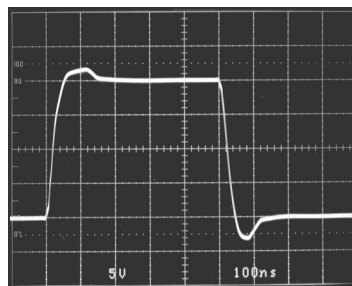

12556 G35

Large-Signal Transient ($A_V = 1, C_L = 10,000pF$)

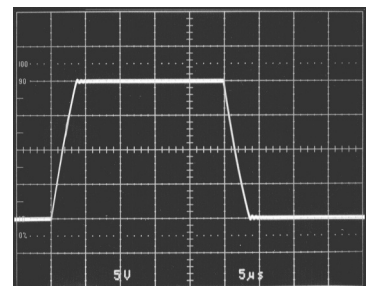

12556 G36

APPLICATIONS INFORMATION

Layout and Passive Components

The LT1355/LT1356 amplifiers are easy to use and tolerant of less than ideal layouts. For maximum performance (for example, fast 0.01% settling) use a ground plane, short lead lengths, and RF-quality bypass capacitors (0.01 μ F to 0.1 μ F). For high drive current applications use low ESR bypass capacitors (1 μ F to 10 μ F tantalum).

The parallel combination of the feedback resistor and gain setting resistor on the inverting input combine with the input capacitance to form a pole which can cause peaking or oscillations. If feedback resistors greater than 5k are used, a parallel capacitor of value:

$$C_F > R_G \times C_{IN}/R_F$$

should be used to cancel the input pole and optimize dynamic performance. For unity-gain applications where a large feedback resistor is used, C_F should be greater than or equal to C_{IN} .

Capacitive Loading

The LT1355/LT1356 are stable with any capacitive load. As the capacitive load increases, both the bandwidth and phase margin decrease so there will be peaking in the frequency domain and in the transient response. Coaxial cable can be driven directly, but for best pulse fidelity a resistor of value equal to the characteristic impedance of the cable (i.e., 75 Ω) should be placed in series with the output. The other end of the cable should be terminated with the same value resistor to ground.

Input Considerations

Each of the LT1355/LT1356 inputs is the base of an NPN and a PNP transistor whose base currents are of opposite polarity and provide first-order bias current cancellation. Because of variation in the matching of NPN and PNP beta, the polarity of the input bias current can be positive or negative. The offset current does not depend on NPN/PNP beta matching and is well controlled. The use of balanced source resistance at each input is recommended for applications where DC accuracy must be maximized.

The inputs can withstand transient differential input voltages up to 10V without damage and need no clamping or source resistance for protection. Differential inputs, however, generate large supply currents (tens of mA) as required for high slew rates. If the device is used with sustained differential inputs, the average supply current will increase, excessive power dissipation will result and the part may be damaged. **The part should not be used as a comparator, peak detector or other open-loop application with large, sustained differential inputs.** Under normal, closed-loop operation, an increase of power dissipation is only noticeable in applications with large slewing outputs and is proportional to the magnitude of the differential input voltage and the percent of the time that the inputs are apart. Measure the average supply current for the application in order to calculate the power dissipation.

Circuit Operation

The LT1355/LT1356 circuit topology is a true voltage feedback amplifier that has the slewing behavior of a current feedback amplifier. The operation of the circuit can be understood by referring to the simplified schematic. The inputs are buffered by complementary NPN and PNP emitter followers which drive an 800 Ω resistor. The input voltage appears across the resistor generating currents which are mirrored into the high impedance node. Complementary followers form an output stage which buffers the gain node from the load. The bandwidth is set by the input resistor and the capacitance on the high impedance node. The slew rate is determined by the current available to charge the gain node capacitance. This current is the differential input voltage divided by R_1 , so the slew rate is proportional to the input. Highest slew rates are therefore seen in the lowest gain configurations. For example, a 10V output step in a gain of 10 has only a 1V input step, whereas the same output step in unity gain has a 10 times greater input step. The curve of Slew Rate vs Input Level illustrates this relationship. The LT1355/LT1356 are tested for slew rate in a gain of -2 so higher slew rates can be expected in gains of 1 and -1 , and lower slew rates in higher gain configurations.

APPLICATIONS INFORMATION

The RC network across the output stage is bootstrapped when the amplifier is driving a light or moderate load and has no effect under normal operation. When driving a capacitive load (or a low value resistive load) the network is incompletely bootstrapped and adds to the compensation at the high impedance node. The added capacitance slows down the amplifier which improves the phase margin by moving the unity-gain frequency away from the pole formed by the output impedance and the capacitive load. The zero created by the RC combination adds phase to ensure that even for very large load capacitances, the total phase lag can never exceed 180 degrees (zero phase margin) and the amplifier remains stable.

Power Dissipation

The LT1355/LT1356 combine high speed and large output drive in small packages. Because of the wide supply voltage range, it is possible to exceed the maximum junction temperature under certain conditions. Maximum junction

temperature (T_J) is calculated from the ambient or case temperature (T_A or T_C) and power dissipation (P_D) as follows:

$$\text{LT1355CN8: } T_J = T_A + (P_D \cdot 130^\circ\text{C/W})$$

$$\text{LT1355CS8: } T_J = T_A + (P_D \cdot 190^\circ\text{C/W})$$

$$\text{LT1356CN: } T_J = T_A + (P_D \cdot 110^\circ\text{C/W})$$

$$\text{LT1356CS: } T_J = T_A + (P_D \cdot 150^\circ\text{C/W})$$

$$\text{LT1356HS: } T_J = T_C + (P_D \cdot 30^\circ\text{C/W})$$

Worst-case power dissipation occurs at the maximum supply current and when the output voltage is at 1/2 of either supply voltage (or the maximum swing if less than 1/2 supply voltage). For each amplifier $P_{D\text{MAX}}$ is:

$$P_{D\text{MAX}} = (V^+ - V^-)(I_{S\text{MAX}}) + (V^+/2)^2/R_L$$

Example: LT1356 in S16 at $T_A = 70^\circ\text{C}$, $V_S = \pm 15\text{V}$, $R_L = 1\text{k}$

$$P_{D\text{MAX}} = (30\text{V})(1.45\text{mA}) + (7.5\text{V})^2/1\text{k}\Omega = 99.8\text{mW}$$

$$T_{J\text{MAX}} = 70^\circ\text{C} + (4 \cdot 99.8\text{mW})(150^\circ\text{C/W}) = 130^\circ\text{C}$$

SIMPLIFIED SCHEMATIC

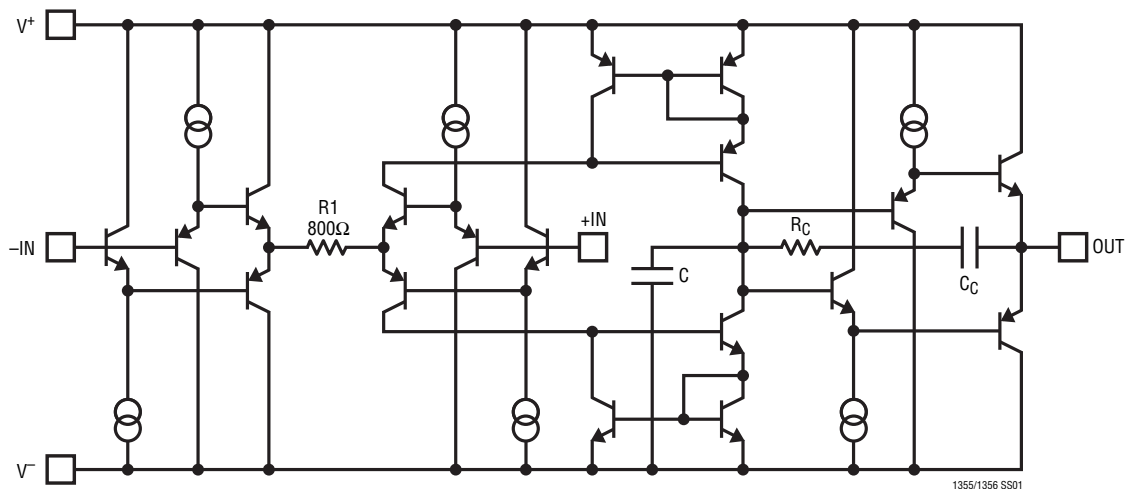

PACKAGE DESCRIPTION

N Package
8-Lead PDIP (Narrow .300 Inch)
 (Reference LTC DWG # 05-08-1510 Rev I)

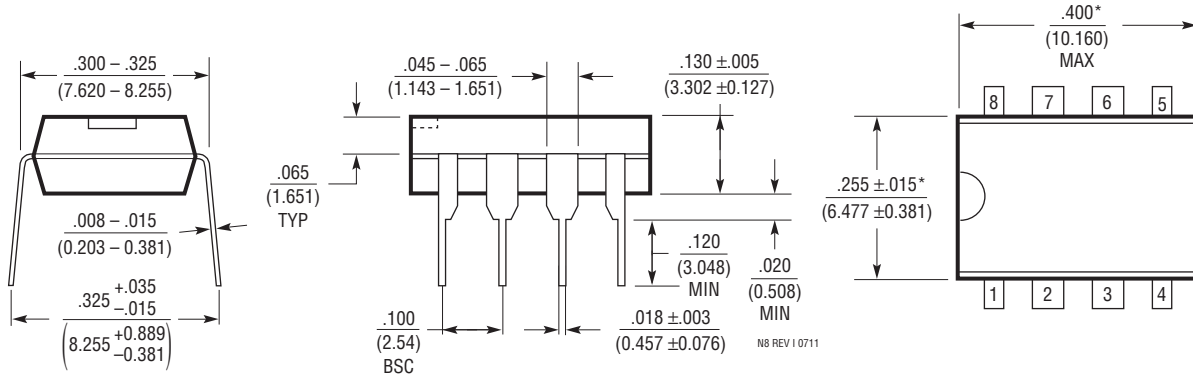

NOTE:

1. DIMENSIONS ARE $\frac{\text{INCHES}}{\text{MILLIMETERS}}$

*THESE DIMENSIONS DO NOT INCLUDE MOLD FLASH OR PROTRUSIONS.
 MOLD FLASH OR PROTRUSIONS SHALL NOT EXCEED .010 INCH (0.254mm)

N Package
14-Lead PDIP (Narrow .300 Inch)
 (Reference LTC DWG # 05-08-1510 Rev I)

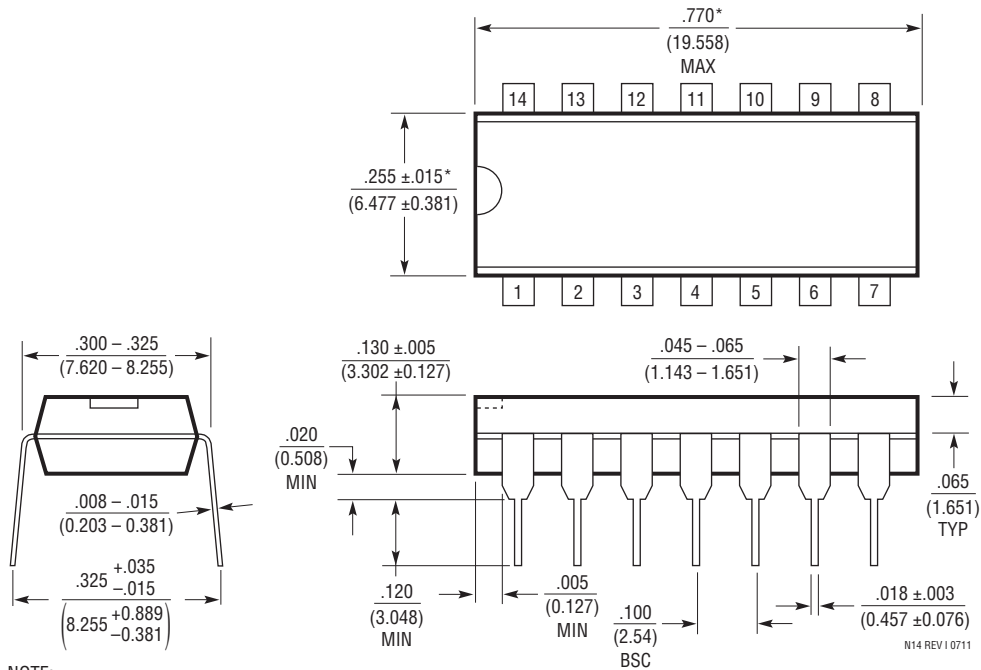

NOTE:

1. DIMENSIONS ARE $\frac{\text{INCHES}}{\text{MILLIMETERS}}$

*THESE DIMENSIONS DO NOT INCLUDE MOLD FLASH OR PROTRUSIONS.
 MOLD FLASH OR PROTRUSIONS SHALL NOT EXCEED .010 INCH (0.254mm)

PACKAGE DESCRIPTION

S8 Package
8-Lead Plastic Small Outline (Narrow .150 Inch)
 (Reference LTC DWG # 05-08-1610)

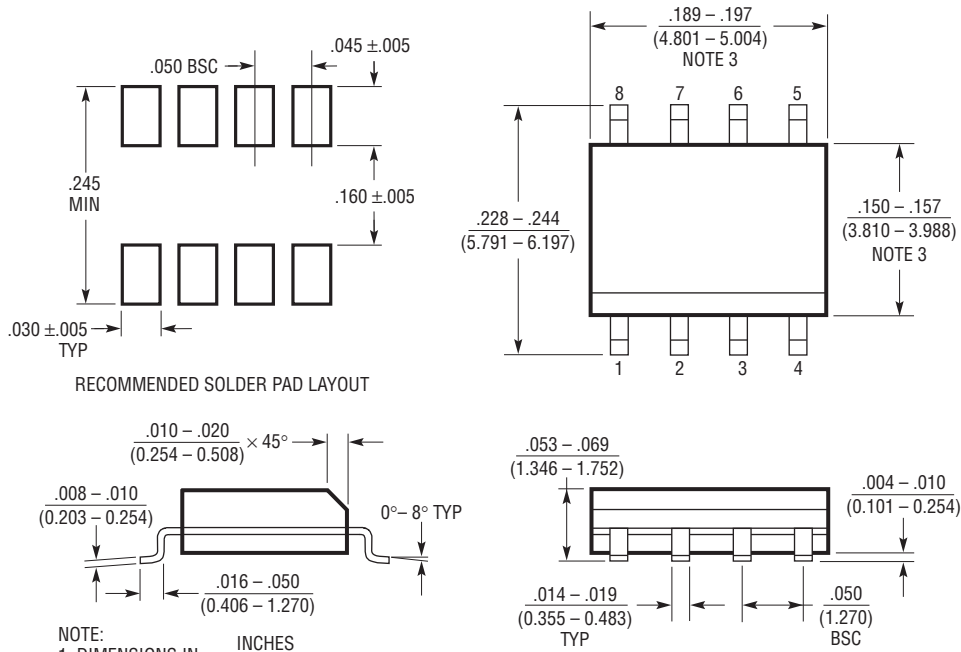

- NOTE:
1. DIMENSIONS IN $\frac{\text{INCHES}}{\text{MILLIMETERS}}$
 2. DRAWING NOT TO SCALE
 3. THESE DIMENSIONS DO NOT INCLUDE MOLD FLASH OR PROTRUSIONS. MOLD FLASH OR PROTRUSIONS SHALL NOT EXCEED $.006''$ (0.15mm)

S08 0303

PACKAGE DESCRIPTION

S Package
16-Lead Plastic Small Outline (Narrow .150 Inch)
 (Reference LTC DWG # 05-08-1610)

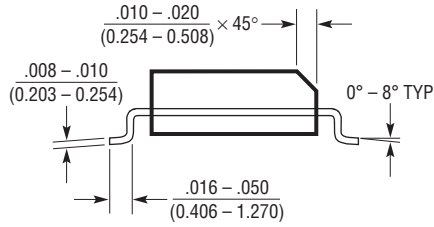
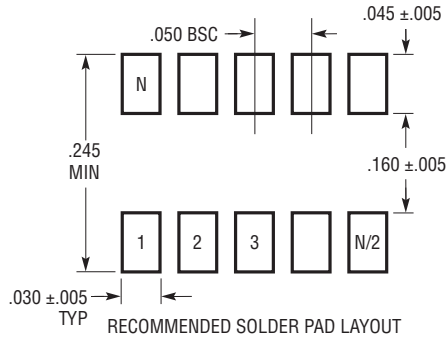

- NOTE:
 1. DIMENSIONS IN $\frac{\text{INCHES}}{\text{MILLIMETERS}}$
 2. DRAWING NOT TO SCALE
 3. THESE DIMENSIONS DO NOT INCLUDE MOLD FLASH OR PROTRUSIONS.
 MOLD FLASH OR PROTRUSIONS SHALL NOT EXCEED .006" (0.15mm)

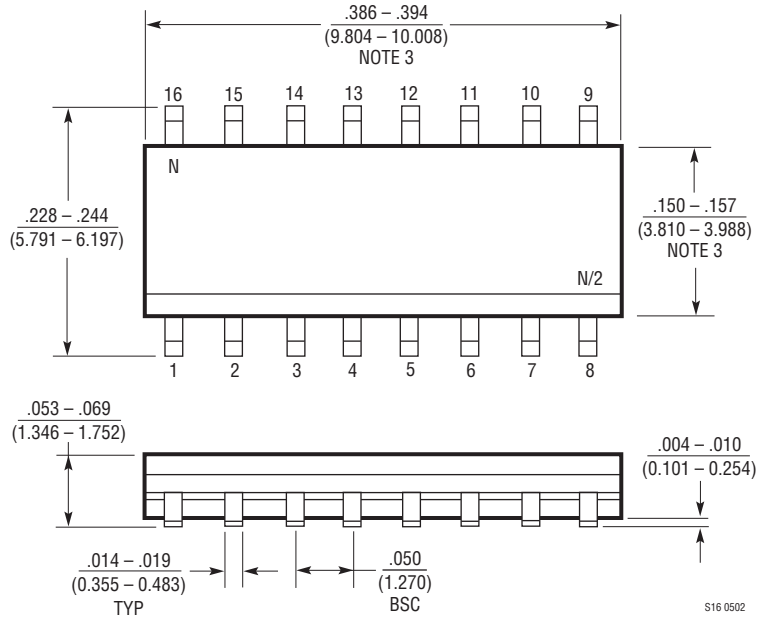

S16 0502

REVISION HISTORY (Revision history begins at Rev C)

| REV | DATE | DESCRIPTION | PAGE NUMBER |
|-----|-------|-----------------------|-------------|
| C | 05/12 | Added H- and I-grades | 2, 5, 11 |

TYPICAL APPLICATIONS

Instrumentation Amplifier

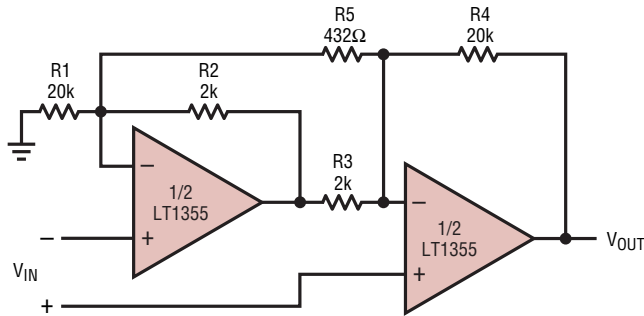

$$A_V = \frac{R_4}{R_3} \left[1 + \frac{1}{2} \left(\frac{R_2}{R_1 + R_4} \right) + \frac{R_2 + R_3}{R_5} \right] = 104$$

TRIM R5 FOR GAIN
TRIM R1 FOR COMMON MODE REJECTION
BW = 120kHz

1355/1356 TA03

100kHz, 4th Order Butterworth Filter (Sallen-Key)

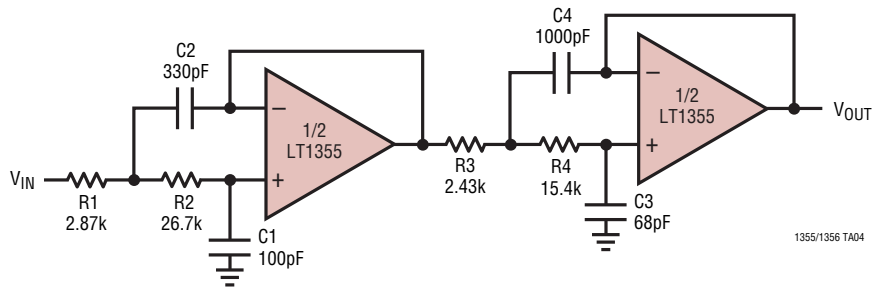

1355/1356 TA04

RELATED PARTS

| PART NUMBER | DESCRIPTION | COMMENTS |
|---------------|--|---|
| LT1354 | 12MHz, 400V/μs Op Amp | Single Version of LT1355/LT1356 |
| LT1352/LT1353 | Dual and Quad 250μA, 3MHz, 200V/μs Op Amps | Lower Power Version of LT1355/LT1356, V _{OS} = 0.6mV, I _S = 250μA/Amplifier |
| LT1358/LT1359 | Dual and Quad 25MHz, 600V/μs Op Amps | Faster Version of LT1355/LT1356, V _{OS} = 0.6mV, I _S = 2mA/Amplifier |

Компания «Life Electronics» занимается поставками электронных компонентов импортного и отечественного производства от производителей и со складов крупных дистрибьюторов Европы, Америки и Азии.

С конца 2013 года компания активно расширяет линейку поставок компонентов по направлению коаксиальный кабель, кварцевые генераторы и конденсаторы (керамические, пленочные, электролитические), за счёт заключения дистрибьюторских договоров

Мы предлагаем:

- Конкурентоспособные цены и скидки постоянным клиентам.
- Специальные условия для постоянных клиентов.
- Подбор аналогов.
- Поставку компонентов в любых объемах, удовлетворяющих вашим потребностям.
- Приемлемые сроки поставки, возможна ускоренная поставка.
- Доставку товара в любую точку России и стран СНГ.
- Комплексную поставку.
- Работу по проектам и поставку образцов.
- Формирование склада под заказчика.
- Сертификаты соответствия на поставляемую продукцию (по желанию клиента).
- Тестирование поставляемой продукции.
- Поставку компонентов, требующих военную и космическую приемку.
- Входной контроль качества.
- Наличие сертификата ISO.

В составе нашей компании организован Конструкторский отдел, призванный помогать разработчикам, и инженерам.

Конструкторский отдел помогает осуществить:

- Регистрацию проекта у производителя компонентов.
- Техническую поддержку проекта.
- Защиту от снятия компонента с производства.
- Оценку стоимости проекта по компонентам.
- Изготовление тестовой платы монтаж и пусконаладочные работы.



Тел: +7 (812) 336 43 04 (многоканальный)

Email: org@lifeelectronics.ru