

The S-93C46B/56B/66B is a 3-wire, high speed, low current consumption, 1/2/4 K-bit serial E²PROM with a wide operating voltage range. It is organized as 64-word × 16-bit, 128-word × 16-bit, 256-word × 16-bit, respectively. Each is capable of sequential read, at which time addresses are automatically incremented in 16-bit blocks. The communication method is by the Microwire bus.

■ Features

- Low current consumption

Standby:	1.5 μA Max. (V _{CC} = 5.5 V)
Read:	0.8 mA Max. (V _{CC} = 5.5 V)
	0.4 mA Max. (V _{CC} = 2.5 V)
- Wide operating voltage range

Read:	1.8 to 5.5 V
Write:	2.7 to 5.5 V
- Sequential read capable
- Write protect function during the low power supply voltage
- Function to protect against write due to erroneous instruction recognition
- Endurance: 10⁶ cycles/word^{*1} (at +85°C)
- Data retention: 100 years (at +25°C)
20 years (at +85°C)
- S-93C46B: 1 K-bit
- S-93C56B: 2 K-bit
- S-93C66B: 4 K-bit
- Lead-free, Sn 100%, halogen-free^{*2}

*1. For each address (Word: 16-bit)

*2. Refer to “**■ Product Name Structure**” for details.

■ Packages

- 8-Pin DIP
- 8-Pin SOP (JEDEC)
- 8-Pin TSSOP
- SNT-8A
- TMSOP-8

Caution This product is intended to use in general electronic devices such as consumer electronics, office equipment, and communications devices. Before using the product in medical equipment or automobile equipment including car audio, keyless entry and engine control unit, contact to SII is indispensable.

■ **Pin Configurations**



Figure 1

S-93C46BD0I-D8S1G
S-93C56BD0I-D8S1G
S-93C66BD0I-D8S1G

Table 1

Pin No.	Symbol	Description
1	CS	Chip select input
2	SK	Serial clock input
3	DI	Serial data input
4	DO	Serial data output
5	GND	Ground
6	TEST ^{*1}	Test
7	NC	No connection
8	VCC	Power supply

*1. Connect to GND or V_{CC}.
Even if this pin is not connected, performance is not affected so long as the absolute maximum rating is not exceeded.



Figure 2

S-93C46BD0I-J8T1x
S-93C56BD0I-J8T1x
S-93C66BD0I-J8T1x

Table 2

Pin No.	Symbol	Description
1	CS	Chip select input
2	SK	Serial clock input
3	DI	Serial data input
4	DO	Serial data output
5	GND	Ground
6	TEST ^{*1}	Test
7	NC	No connection
8	VCC	Power supply

*1. Connect to GND or V_{CC}.
Even if this pin is not connected, performance is not affected so long as the absolute maximum rating is not exceeded.

8-Pin SOP(JEDEC) (Rotated)
Top view

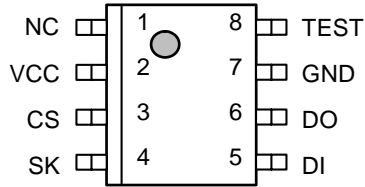

Figure 3

S-93C46BR0I-J8T1x
S-93C56BR0I-J8T1x
S-93C66BR0I-J8T1x

Table 3

Pin No.	Symbol	Description
1	NC	No connection
2	VCC	Power supply
3	CS	Chip select input
4	SK	Serial clock input
5	DI	Serial data input
6	DO	Serial data output
7	GND	Ground
8	TEST ^{*1}	Test

^{*1}. Connect to GND or V_{CC}.
Even if this pin is not connected, performance is not affected so long as the absolute maximum rating is not exceeded.

8-Pin TSSOP
Top view

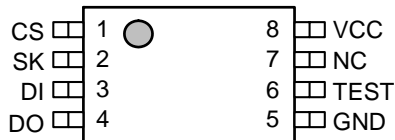

Figure 4

S-93C46BD0I-T8T1x
S-93C56BD0I-T8T1x
S-93C66BD0I-T8T1x

Table 4

Pin No.	Symbol	Description
1	CS	Chip select input
2	SK	Serial clock input
3	DI	Serial data input
4	DO	Serial data output
5	GND	Ground
6	TEST ^{*1}	Test
7	NC	No connection
8	VCC	Power supply

^{*1}. Connect to GND or V_{CC}.
Even if this pin is not connected, performance is not affected so long as the absolute maximum rating is not exceeded.



Figure 5

S-93C46BD0I-I8T1x
S-93C56BD0I-I8T1x
S-93C66BD0I-I8T1x

Table 5

Pin No.	Symbol	Description
1	CS	Chip select input
2	SK	Serial clock input
3	DI	Serial data input
4	DO	Serial data output
5	GND	Ground
6	TEST ^{*1}	Test
7	NC	No connection
8	VCC	Power supply

*1. Connect to GND or V_{CC}.

Even if this pin is not connected, performance is not affected so long as the absolute maximum rating is not exceeded.

Remark See Dimensions for details of the package drawings.



Figure 6

S-93C46BD0I-K8T3U
S-93C56BD0I-K8T3U
S-93C66BD0I-K8T3U

Table 6

Pin No.	Symbol	Description
1	CS	Chip select input
2	SK	Serial clock input
3	DI	Serial data input
4	DO	Serial data output
5	GND	Ground
6	TEST ^{*1}	Test
7	NC	No connection
8	VCC	Power supply

*1. Connect to GND or V_{CC}.

Even if this pin is not connected, performance is not affected so long as the absolute maximum rating is not exceeded.

Remark 1. See Dimensions for details of the package drawings.

2. x: G or U

3. Please select products of environmental code = U for Sn 100%, halogen-free products.

■ Block Diagram



Figure 7

■ Instruction Sets

1. S-93C46B

Table 7

Instruction SK input clock	Start Bit	Operation Code		Address						Data
	1	2	3	4	5	6	7	8	9	10 to 25
READ (Read data)	1	1	0	A5	A4	A3	A2	A1	A0	D15 to D0 Output* ¹
WRITE (Write data)	1	0	1	A5	A4	A3	A2	A1	A0	D15 to D0 Input
ERASE (Erase data)	1	1	1	A5	A4	A3	A2	A1	A0	—
WRAL (Write all)	1	0	0	0	1	x	x	x	x	D15 to D0 Input
ERAL (Erase all)	1	0	0	1	0	x	x	x	x	—
EWEN (Write enable)	1	0	0	1	1	x	x	x	x	—
EWDS (Write disable)	1	0	0	0	0	x	x	x	x	—

*1. When the 16-bit data in the specified address has been output, the data in the next address is output.

Remark x: Don't care

2. S-93C56B

Table 8

Instruction SK input clock	Start Bit	Operation Code		Address							Data	
	1	2	3	4	5	6	7	8	9	10	11	12 to 27
READ (Read data)	1	1	0	x	A6	A5	A4	A3	A2	A1	A0	D15 to D0 Output* ¹
WRITE (Write data)	1	0	1	x	A6	A5	A4	A3	A2	A1	A0	D15 to D0 Input
ERASE (Erase data)	1	1	1	x	A6	A5	A4	A3	A2	A1	A0	—
WRAL (Write all)	1	0	0	0	1	x	x	x	x	x	x	D15 to D0 Input
ERAL (Erase all)	1	0	0	1	0	x	x	x	x	x	x	—
EWEN (Write enable)	1	0	0	1	1	x	x	x	x	x	x	—
EWDS (Write disable)	1	0	0	0	0	x	x	x	x	x	x	—

*1. When the 16-bit data in the specified address has been output, the data in the next address is output.

Remark x: Don't care

3. S-93C66B

Table 9

Instruction SK input clock	Start Bit	Operation Code		Address							Data	
	1	2	3	4	5	6	7	8	9	10	11	12 to 27
READ (Read data)	1	1	0	A7	A6	A5	A4	A3	A2	A1	A0	D15 to D0 Output* ¹
WRITE (Write data)	1	0	1	A7	A6	A5	A4	A3	A2	A1	A0	D15 to D0 Input
ERASE (Erase data)	1	1	1	A7	A6	A5	A4	A3	A2	A1	A0	—
WRAL (Write all)	1	0	0	0	1	x	x	x	x	x	x	D15 to D0 Input
ERAL (Erase all)	1	0	0	1	0	x	x	x	x	x	x	—
EWEN (Write enable)	1	0	0	1	1	x	x	x	x	x	x	—
EWDS (Write disable)	1	0	0	0	0	x	x	x	x	x	x	—

*1. When the 16-bit data in the specified address has been output, the data in the next address is output.

Remark x: Don't care

■ Absolute Maximum Ratings

Table 10

Item	Symbol	Ratings	Unit
Power supply voltage	V_{CC}	-0.3 to +7.0	V
Input voltage	V_{IN}	-0.3 to $V_{CC} + 0.3$	V
Output voltage	V_{OUT}	-0.3 to V_{CC}	V
Operating ambient temperature	T_{opr}	-40 to +105	°C
Storage temperature	T_{stg}	-65 to +150	°C

Caution The absolute maximum ratings are rated values exceeding which the product could suffer physical damage. These values must therefore not be exceeded under any conditions.

■ Recommended Operating Conditions

Table 11

(Ta = -40 to +85°C unless otherwise specified)

Item	Symbol	Conditions	Min.	Max.	Unit
Power supply voltage	V_{CC}	READ, EWDS	1.8	5.5	V
		WRITE, ERASE, WRAL, ERAL, EWEN	2.7	5.5	V
High level input voltage	V_{IH}	$V_{CC} = 4.5$ to 5.5 V	2.0	V_{CC}	V
		$V_{CC} = 2.7$ to 4.5 V	$0.8 \times V_{CC}$	V_{CC}	V
		$V_{CC} = 1.8$ to 2.7 V	$0.8 \times V_{CC}$	V_{CC}	V
Low level input voltage	V_{IL}	$V_{CC} = 4.5$ to 5.5 V	0.0	0.8	V
		$V_{CC} = 2.7$ to 4.5 V	0.0	$0.2 \times V_{CC}$	V
		$V_{CC} = 1.8$ to 2.7 V	0.0	$0.15 \times V_{CC}$	V

■ Pin Capacitance

Table 12

(Ta = +25°C, f = 1.0 MHz, $V_{CC} = 5.0$ V)

Item	Symbol	Conditions	Min.	Max.	Unit
Input Capacitance	C_{IN}	$V_{IN} = 0$ V	—	8	pF
Output Capacitance	C_{OUT}	$V_{OUT} = 0$ V	—	10	pF

■ Endurance

Table 13

Item	Symbol	Operating Ambient Temperature	Min.	Max.	Unit
Endurance	N_W	-40 to +85°C	10^6	—	cycles/word*1

*1. For each address (Word: 16 bits)

■ Data Retention

Table 14

Item	Symbol	Operation Ambient Temperature	Min.	Max.	Unit
Data retention	—	+25°C	100	—	year
		-40 to +85°C	20	—	year

■ DC Electrical Characteristics

Table 15

(Ta = -40 to +85°C unless otherwise specified)

Item	Symbol	Conditions	V _{CC} = 4.5 to 5.5 V		V _{CC} = 2.5 to 4.5 V		V _{CC} = 1.8 to 2.5 V		Unit
			Min.	Max.	Min.	Max.	Min.	Max.	
Current consumption (READ)	I _{CC1}	DO no load	—	0.8	—	0.5	—	0.4	mA

Table 16

(Ta = -40 to +85°C unless otherwise specified)

Item	Symbol	Conditions	V _{CC} = 4.5 to 5.5 V		V _{CC} = 2.7 to 4.5 V		Unit
			Min.	Max.	Min.	Max.	
Current consumption (WRITE)	I _{CC2}	DO no load	—	2.0	—	1.5	mA

Table 17

(Ta = -40 to +85°C unless otherwise specified)

Item	Symbol	Conditions	V _{CC} = 4.5 to 5.5 V		V _{CC} = 2.5 to 4.5 V		V _{CC} = 1.8 to 2.5 V		Unit
			Min.	Max.	Min.	Max.	Min.	Max.	
Standby current consumption	I _{SB}	CS = GND, DO = Open, Other inputs to V _{CC} or GND	—	1.5	—	1.5	—	1.5	μA
Input leakage current	I _{LI}	V _{IN} = GND to V _{CC}	—	1.0	—	1.0	—	1.0	μA
Output leakage current	I _{LO}	V _{OUT} = GND to V _{CC}	—	1.0	—	1.0	—	1.0	μA
Low level output voltage	V _{OL}	I _{OL} = 2.1 mA	—	0.4	—	—	—	—	V
		I _{OL} = 100 μA	—	0.1	—	0.1	—	0.1	V
High level output voltage	V _{OH}	I _{OH} = -400 μA	2.4	—	—	—	—	—	V
		I _{OH} = -100 μA	V _{CC} - 0.3	—	V _{CC} - 0.3	—	—	—	V
		I _{OH} = -10 μA	V _{CC} - 0.2	—	V _{CC} - 0.2	—	V _{CC} - 0.2	—	V
Write enable latch data hold voltage	V _{DH}	Only when write disable mode	1.5	—	1.5	—	1.5	—	V

■ AC Electrical Characteristics

Table 18 Measurement Conditions

Input pulse voltage	$0.1 \times V_{CC}$ to $0.9 \times V_{CC}$
Output reference voltage	$0.5 \times V_{CC}$
Output load	100 pF

Table 19

(Ta = -40 to +85°C unless otherwise specified)

Item	Symbol	V _{CC} = 4.5 to 5.5 V		V _{CC} = 2.5 to 4.5 V		V _{CC} = 1.8 to 2.5 V		Unit
		Min.	Max.	Min.	Max.	Min.	Max.	
CS setup time	t _{CSS}	0.2	—	0.4	—	1.0	—	μs
CS hold time	t _{CSH}	0	—	0	—	0	—	μs
CS deselect time	t _{CDS}	0.2	—	0.2	—	0.4	—	μs
Data setup time	t _{DS}	0.1	—	0.2	—	0.4	—	μs
Data hold time	t _{DH}	0.1	—	0.2	—	0.4	—	μs
Output delay time	t _{PD}	—	0.4	—	0.8	—	2.0	μs
Clock frequency ^{*1}	f _{SK}	0	2.0	0	0.5	0	0.25	MHz
SK clock time "L" ^{*1}	t _{SKL}	0.1	—	0.5	—	1.0	—	μs
SK clock time "H" ^{*1}	t _{SKH}	0.1	—	0.5	—	1.0	—	μs
Output disable time	t _{HZ1} , t _{HZ2}	0	0.15	0	0.5	0	1.0	μs
Output enable time	t _{SV}	0	0.15	0	0.5	0	1.0	μs

*1. The clock cycle of the SK clock (frequency: f_{SK}) is 1/f_{SK} μs. This clock cycle is determined by a combination of several AC characteristics, so be aware that even if the SK clock cycle time is minimized, the clock cycle (1/f_{SK}) cannot be made equal to t_{SKL}(Min.) + t_{SKH}(Min.).

Table 20

(Ta = -40 to +85°C unless otherwise specified)

Item	Symbol	V _{CC} = 2.7 to 5.5 V			Unit
		Min.	Typ.	Max.	
Write time	t _{PR}	—	4.0	8.0	ms



- *1. Indicates high impedance.
- *2. $1/f_{SK}$ is the SK clock cycle. This clock cycle is determined by a combination of several AC characteristics, so be aware that even if the SK clock cycle time is minimized, the clock cycle ($1/f_{SK}$) cannot be made equal to $t_{SKL}(\text{Min.}) + t_{SKH}(\text{Min.})$.

Figure 8 Timing Chart

■ Operation

All instructions are executed by inputting DI in synchronization with the rising edge of SK after CS goes high. An instruction set is input in the order of start bit, instruction, address, and data.

Instruction input finishes when CS goes low. A low level must be input to CS between commands during t_{CDS} . While a low level is being input to CS, the S-93C46B/56B/66B is in standby mode, so the SK and DI inputs are invalid and no instructions are allowed.

■ Start Bit

A start bit is recognized when the DI pin goes high at the rise of SK after CS goes high. After CS goes high, a start bit is not recognized even if the SK pulse is input as long as the DI pin is low.

1. Dummy clock

SK clocks input while the DI pin is low before a start bit is input are called dummy clocks. Dummy clocks are effective when aligning the number of instruction sets (clocks) sent by the CPU with those required for serial memory operation. For example, when a CPU instruction set is 16 bits, the number of instruction set clocks can be adjusted by inserting a 7-bit dummy clock for the S-93C46B and a 5-bit dummy clock for the S-93C56B/66B.

2. Start bit input failure

- When the output status of the DO pin is high during the verify period after a write operation, if a high level is input to the DI pin at the rising edge of SK, the S-93C46B/56B/66B recognizes that a start bit has been input. To prevent this failure, input a low level to the DI pin during the verify operation period (refer to “**4.1 Verify operation**”).
- When a 3-wire interface is configured by connecting the DI input pin and DO output pin, a period in which the data output from the CPU and the serial memory collide may be generated, preventing successful input of the start bit. Take the measures described in “**■ 3-Wire Interface (Direct Connection between DI and DO)**”.

3. Reading (READ)

The READ instruction reads data from a specified address.

After CS has gone high, input an instruction in the order of the start bit, read instruction, and address. Since the last input address (A_0) has been latched, the output status of the DO pin changes from high impedance (High-Z) to low, which is held until the next rise of SK. 16-bit data starts to be output in synchronization with the next rise of SK.

3.1 Sequential read

After the 16-bit data at the specified address has been output, inputting SK while CS is high automatically increments the address, and causes the 16-bit data at the next address to be output sequentially. The above method makes it possible to read the data in the whole memory space. The last address ($A_n \dots A_1 A_0 = 1 \dots 1 1$) rolls over to the top address ($A_n \dots A_1 A_0 = 0 \dots 0 0$).



Figure 9 Read Timing (S-93C46B)



Figure 10 Read Timing (S-93C56B, S-93C66B)

4. Writing (WRITE, ERASE, WRAL, ERAL)

A write operation includes four write instructions: data write (WRITE), data erase (ERASE), chip write (WRAL), and chip erase (ERAL).

A write instruction (WRITE, ERASE, WRAL, ERAL) starts a write operation to the memory cell when a low level is input to CS after a specified number of clocks have been input. The SK and DI inputs are invalid during the write period, so do not input an instruction.

Input an instruction while the output status of the DO pin is high or high impedance (High-Z).

A write operation is valid only in program enable mode (refer to “5. Write enable (EWEN) and write disable (EWDS)”).

4.1 Verify operation

A write operation executed by any instruction is completed within 8 ms (write time t_{PR} : typically 4 ms), so if the completion of the write operation is recognized, the write cycle can be minimized. A sequential operation to confirm the status of a write operation is called a verify operation.

(1) Operation

After the write operation has started (CS = low), the status of the write operation can be verified by confirming the output status of the DO pin by inputting a high level to CS again. This sequence is called a verify operation, and the period that a high level is input to the CS pin after the write operation has started is called the verify operation period.

The relationship between the output status of the DO pin and the write operation during the verify operation period is as follows.

- DO pin = low: Writing in progress (busy)
- DO pin = high: Writing completed (ready)

(2) Operation example

There are two methods to perform a verify operation: Waiting for a change in the output status of the DO pin while keeping CS high, or suspending the verify operation (CS = low) once and then performing it again to verify the output status of the DO pin. The latter method allows the CPU to perform other processing during the wait period, allowing an efficient system to be designed.

- Caution**
1. Input a low level to the DI pin during a verify operation.
 2. If a high level is input to the DI pin at the rise of SK when the output status of the DO pin is high, the S-93C46B/56B/66B latches the instruction assuming that a start bit has been input. In this case, note that the DO pin immediately enters a high-impedance (High-Z) state.

4.2 Writing data (WRITE)

To write 16-bit data to a specified address, change CS to high and then input the WRITE instruction, address, and 16-bit data following the start bit. The write operation starts when CS goes low. There is no need to set the data to 1 before writing. If the clocks more than the specified number have been input, the clock pulse monitoring circuit cancels the WRITE instruction. For details of the clock pulse monitoring circuit, refer to “■ Function to Protect Against Write due to Erroneous Instruction Recognition”.



Figure 11 Data Write Timing (S-93C46B)



Figure 12 Data Write Timing (S-93C56B, S-93C66B)

4.3 Erasing data (ERASE)

To erase 16-bit data at a specified address, set all 16 bits of the data to 1, change CS to high, and then input the ERASE instruction and address following the start bit. There is no need to input data. The data erase operation starts when CS goes low. If the clocks more than the specified number have been input, the clock pulse monitoring circuit cancels the ERASE instruction. For details of the clock pulse monitoring circuit, refer to “**Function to Protect Against Write due to Erroneous Instruction Recognition**”.



Figure 13 Data Erase Timing (S-93C46B)



Figure 14 Data Erase Timing (S-93C56B, S-93C66B)

4.4 Writing to chip (WRAL)

To write the same 16-bit data to the entire memory address space, change CS to high, and then input the WRAL instruction, an address, and 16-bit data following the start bit. Any address can be input. The write operation starts when CS goes low. There is no need to set the data to 1 before writing. If the clocks more than the specified number have been input, the clock pulse monitoring circuit cancels the WRAL instruction. For details of the clock pulse monitoring circuit, refer to “**Function to Protect Against Write due to Erroneous Instruction Recognition**”.



Figure 15 Chip Write Timing (S-93C46B)

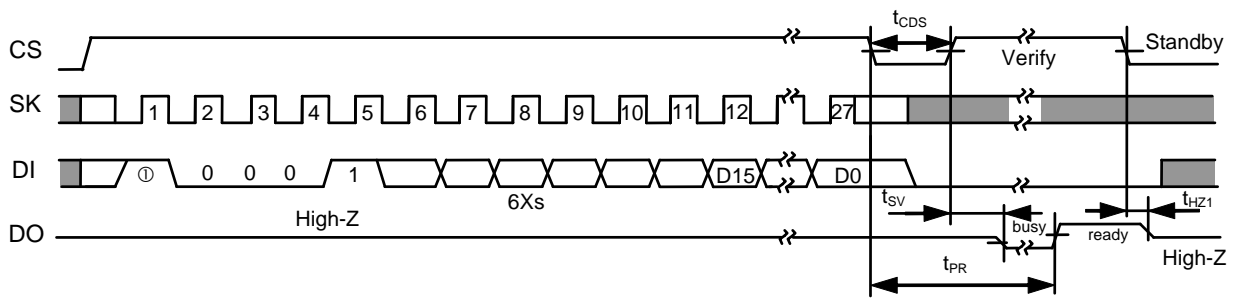

Figure 16 Chip Write Timing (S-93C56B, S-93C66B)

4.5 Erasing chip (ERAL)

To erase the data of the entire memory address space, set all the data to 1, change CS to high, and then input the ERAL instruction and an address following the start bit. Any address can be input. There is no need to input data. The chips erase operation starts when CS goes low. If the clocks more than the specified number have been input, the clock pulse monitoring circuit cancels the ERAL instruction. For details of the clock pulse monitoring circuit, refer to “**Function to Protect Against Write due to Erroneous Instruction Recognition**”.



Figure 17 Chip Erase Timing (S-93C46B)



Figure 18 Chip Erase Timing (S-93C56B, S-93C66B)

5. Write enable (EWEN) and write disable (EWDS)

The EWEN instruction is an instruction that enables a write operation. The status in which a write operation is enabled is called the program enable mode.

The EWDS instruction is an instruction that disables a write operation. The status in which a write operation is disabled is called the program disable mode.

After CS goes high, input an instruction in the order of the start bit, EWEN or EWDS instruction, and address (optional). Each mode becomes valid by inputting a low level to CS after the last address (optional) has been input.



Figure 19 Write Enable/Disable Timing (S-93C46B)



Figure 20 Write Enable/Disable Timing (S-93C56B, S-93C66B)

(1) Recommendation for write operation disable instruction

It is recommended to implement a design that prevents an incorrect write operation when a write instruction is erroneously recognized by executing the write operation disable instruction when executing instructions other than write instruction, and immediately after power-on and before power off.

■ Write Protect Function during the Low Power Supply Voltage

The S-93C46B/56B/66B provides a built-in detector. When the power supply voltage is low or at power application, the write instructions (WRITE, ERASE, WRAL, and ERAL) are cancelled, and the write disable state (EWDS) is automatically set. The detection voltage is 1.75 V typ., the release voltage is 2.05 V typ., and there is a hysteresis of about 0.3 V (refer to **Figure 21**). Therefore, when a write operation is performed after the power supply voltage has dropped and then risen again up to the level at which writing is possible, a write enable instruction (EWEN) must be sent before a write instruction (WRITE, ERASE, WRAL, or ERAL) is executed.

When the power supply voltage drops during a write operation, the data being written to an address at that time is not guaranteed.

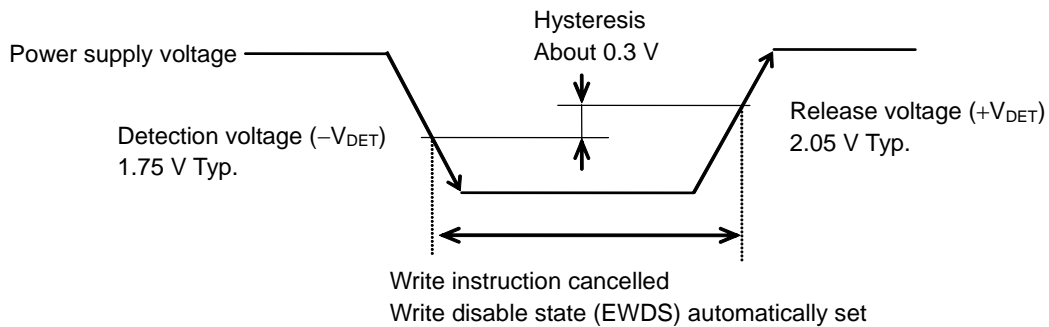

Figure 21 Operation during Low Power Supply Voltage

■ **Function to Protect Against Write due to Erroneous Instruction Recognition**

The S-93C46B/56B/66B provides a built-in clock pulse monitoring circuit which is used to prevent an erroneous write operation by canceling write instructions (WRITE, ERASE, WRAL, and ERAL) recognized erroneously due to an erroneous clock count caused by the application of noise pulses or double counting of clocks. Instructions are cancelled if a clock pulse more or less than specified number decided by each write operation (WRITE, ERASE, WRAL, or ERAL) is detected.

<Example> Erroneous recognition of program disable instruction (EWDS) as erase instruction (ERASE)



In products that do not include a clock pulse monitoring circuit, FFFF is mistakenly written on address 00h. However the S-93C46B detects the overcount and cancels the instruction without performing a write operation.

Figure 22 Example of Clock Pulse Monitoring Circuit Operation

■ 3-Wire Interface (Direct Connection between DI and DO)

There are two types of serial interface configurations: a 4-wire interface configured using the CS, SK, DI, and DO pins, and a 3-wire interface that connects the DI input pin and DO output pin.

When the 3-wire interface is employed, a period in which the data output from the CPU and the data output from the serial memory collide may occur, causing a malfunction. To prevent such a malfunction, connect the DI and DO pins of the S-93C46B/56B/66B via a resistor (10 to 100 k Ω) so that the data output from the CPU takes precedence in being input to the DI pin (refer to “**Figure 23 Connection of 3-Wire Interface**”).



Figure 23 Connection of 3-Wire Interface

■ I/O Pin

1. Connection of input pins

All the input pins of the S-93C46B/56B/66B employ a CMOS structure, so design the equipment so that high impedance will not be input while the S-93C46B/56B/66B is operating. Especially, deselect the CS input (a low level) when turning on/off power and during standby. When the CS pin is deselected (a low level), incorrect data writing will not occur. Connect the CS pin to GND via a resistor (10 to 100 k Ω pull-down resistor). To prevent malfunction, it is recommended to use equivalent pull-down resistors for pins other than the CS pin.

2. Equivalent circuit of input and output pin

The following shows the equivalent circuits of input pins of the S-93C46B/56B/66B. None of the input pins incorporate pull-up and pull-down elements, so special care must be taken when designing to prevent a floating status.

Output pins are high-level/low-level/high-impedance tri-state outputs. The TEST pin is disconnected from the internal circuit by a switching transistor during normal operation. As long as the absolute maximum rating is satisfied, the TEST pin and internal circuit will never be connected.

2.1 Input pin

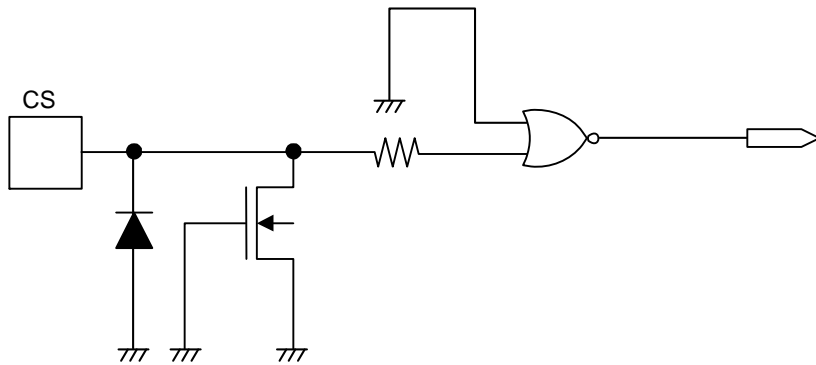

Figure 24 CS Pin

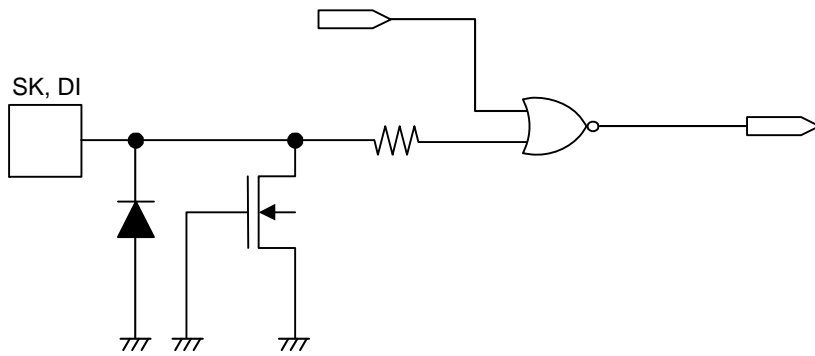

Figure 25 SK, DI Pin

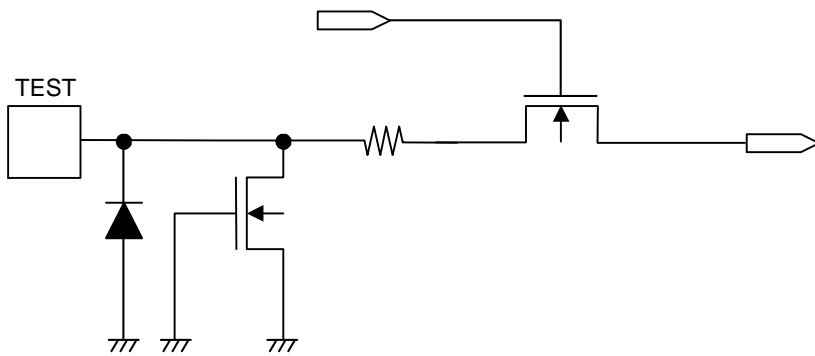

Figure 26 TEST Pin

2.2 Output pin

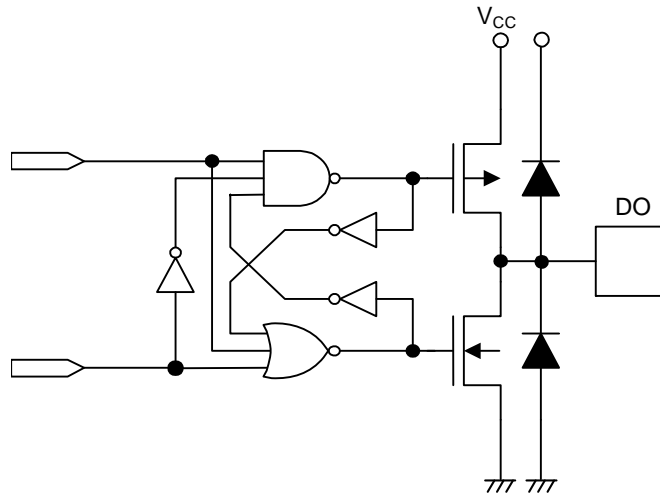

Figure 27 DO Pin

3. Input pin noise elimination time

The S-93C46B/56B/66B include a built-in low-pass filter to eliminate noise at the SK, DI, and CS pins. This means that if the supply voltage is 5.0 V (at room temperature), noise with a pulse width of 20 ns or less can be eliminated.

Note, therefore, the noise with a pulse width of more than 20 ns will be recognized as a pulse if the voltage exceeds V_{IH}/V_{IL} .

■ Precaution

- Do not apply an electrostatic discharge to this IC that exceeds the performance ratings of the built-in electrostatic protection circuit.
- SII claims no responsibility for any and all disputes arising out of or in connection with any infringement by products including this IC of patents owned by a third party.

■ Characteristics (Typical Data)

1. DC Characteristics

1.1 Current consumption (READ) I_{CC1} vs. ambient temperature T_a



1.2 Current consumption (READ) I_{CC1} vs. ambient temperature T_a



1.3 Current consumption (READ) I_{CC1} vs. ambient temperature T_a



1.4 Current consumption (READ) I_{CC1} vs. power supply voltage V_{CC}



1.5 Current consumption (READ) I_{CC1} vs. power supply voltage V_{CC}



1.6 Current consumption (READ) I_{CC1} vs. Clock frequency f_{SK}



1.7 Current consumption (WRITE) I_{CC2} vs. ambient temperature T_a

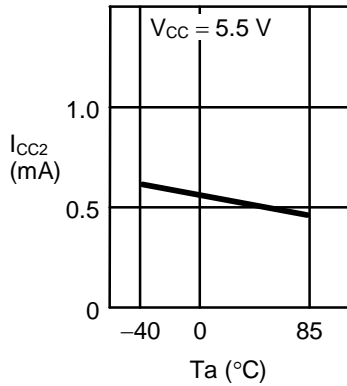

1.8 Current consumption (WRITE) I_{CC2} vs. ambient temperature T_a

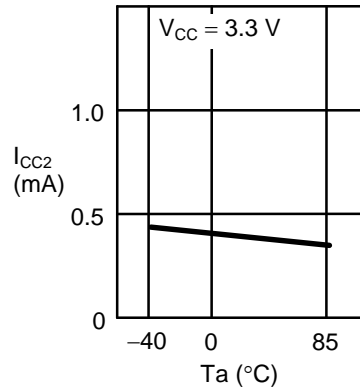

1.9 Current consumption (WRITE) I_{CC2} vs. ambient temperature T_a



1.10 Current consumption (WRITE) I_{CC2} vs. power supply voltage V_{CC}



1.11 Current consumption in standby mode I_{SB} vs. ambient temperature T_a

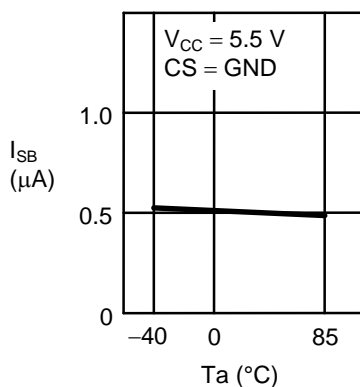

1.12 Current consumption in standby mode I_{SB} vs. power supply voltage V_{CC}

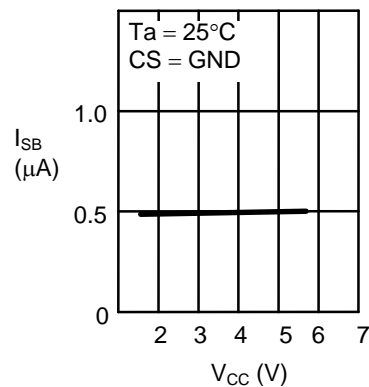

**1. 13 Input leakage current I_{LI}
vs. ambient temperature T_a**

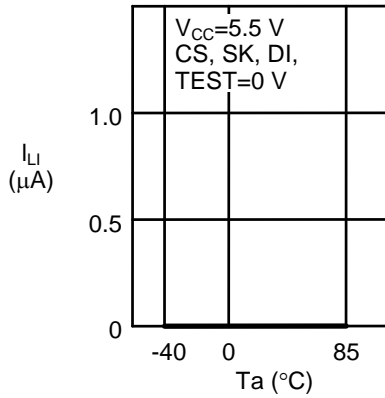

**1. 14 Input leakage current I_{LI}
vs. ambient temperature T_a**



**1. 15 Output leakage current I_{LO}
vs. ambient temperature T_a**



**1. 16 Output leakage current I_{LO}
vs. ambient temperature T_a**



**1. 17 High-level output voltage V_{OH}
vs. ambient temperature T_a**



**1. 18 High-level output voltage V_{OH}
vs. ambient temperature T_a**



1. 19 High-level output voltage V_{OH} vs. ambient temperature T_a



1. 20 High-level output voltage V_{OH} vs. ambient temperature T_a



1. 21 Low-level output voltage V_{OL} vs. ambient temperature T_a



1. 22 Low-level output voltage V_{OL} vs. ambient temperature T_a



1. 23 High-level output current I_{OH} vs. ambient temperature T_a



1. 24 High-level output current I_{OH} vs. ambient temperature T_a



**1. 25 High-level output current I_{OH}
vs. ambient temperature T_a**



**1. 26 High-level output current I_{OH}
vs. ambient temperature T_a**



**1. 27 Low-level output current I_{OL}
vs. ambient temperature T_a**



**1. 28 Low-level output current I_{OL}
vs. ambient temperature T_a**



**1. 29 Input inverted voltage V_{INV}
vs. power supply voltage V_{CC}**

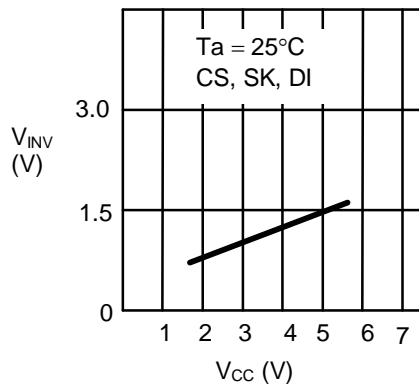

**1. 30 Input inverted voltage V_{INV}
vs. ambient temperature T_a**



1. 31 Low supply voltage detection voltage $-V_{DET}$ vs. ambient temperature T_a



1. 32 Low supply voltage release voltage $+V_{DET}$ vs. ambient temperature T_a



2. AC Characteristics

**2.1 Maximum operating frequency f_{MAX} .
vs. power supply voltage V_{CC}**

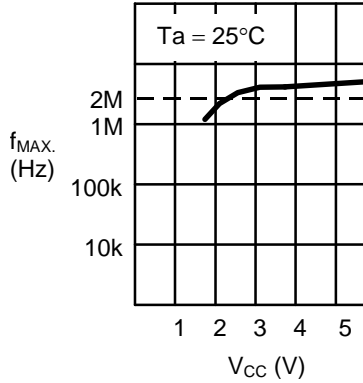

**2.2 Write time t_{PR}
vs. power supply voltage V_{CC}**



**2.3 Write time t_{PR}
vs. ambient temperature T_a**



**2.4 Write time t_{PR}
vs. ambient temperature T_a**

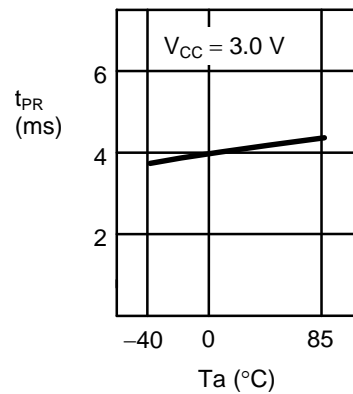

**2.5 Write time t_{PR}
vs. ambient temperature T_a**



**2.6 Data output delay time t_{PD}
vs. ambient temperature T_a**

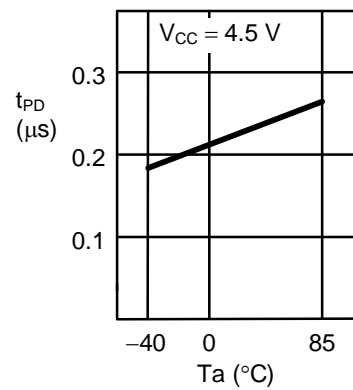

2.7 Data output delay time t_{PD}
vs. ambient temperature T_a



2.8 Data output delay time t_{PD}
vs. ambient temperature T_a



■ **Product Name Structure**

1. Product name

1.1 8-Pin SOP (JEDEC), 8-Pin TSSOP, SNT-8A



1.2 TMSOP-8



1.3 8-Pin DIP



2. Package

Package name		Drawing code			
		Package	Tape	Reel	Land
8-Pin DIP		DP008-F-P-SD	—	—	—
8-Pin SOP (JEDEC)	Environmental code = G	FJ008-A-P-SD	FJ008-D-C-SD	FJ008-D-R-SD	—
	Environmental code = U	FJ008-A-P-SD	FJ008-D-C-SD	FJ008-D-R-S1	—
8-Pin TSSOP	Environmental code = G	FT008-A-P-SD	FT008-E-C-SD	FT008-E-R-SD	—
	Environmental code = U	FT008-A-P-SD	FT008-E-C-SD	FT008-E-R-S1	—
SNT-8A		PH008-A-P-SD	PH008-A-C-SD	PH008-A-R-SD	PH008-A-L-SD
TMSOP-8		FM008-A-P-SD	FM008-A-C-SD	FM008-A-R-SD	—

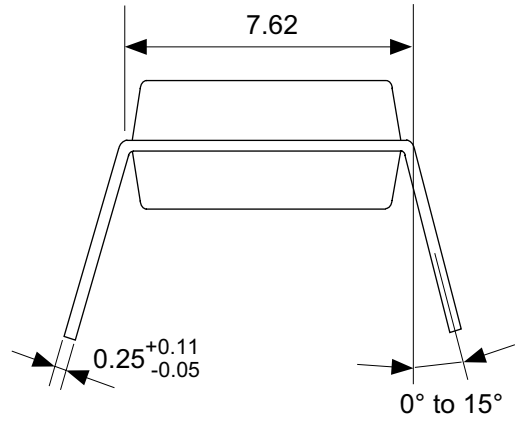
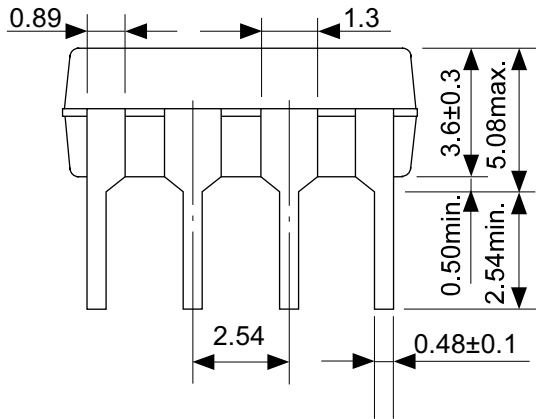
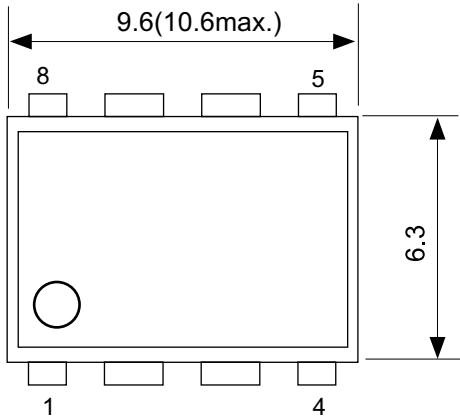

No. DP008-F-P-SD-3.0

TITLE	DIP8-F-PKG Dimensions
No.	DP008-F-P-SD-3.0
SCALE	
UNIT	mm
Seiko Instruments Inc.	



No. FJ008-A-P-SD-2.1

TITLE	SOP8J-D-PKG Dimensions
No.	FJ008-A-P-SD-2.1
SCALE	
UNIT	mm
Seiko Instruments Inc.	



No. FJ008-D-C-SD-1.1

TITLE	SOP8J-D-Carrier Tape
No.	FJ008-D-C-SD-1.1
SCALE	
UNIT	mm
Seiko Instruments Inc.	



Enlarged drawing in the central part



No. FJ008-D-R-SD-1.1

TITLE	SOP8J-D-Reel		
No.	FJ008-D-R-SD-1.1		
SCALE		QTY.	2,000
UNIT	mm		
Seiko Instruments Inc.			

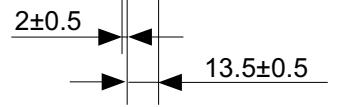

Enlarged drawing in the central part



No. FJ008-D-R-S1-1.0

TITLE	SOP8J-D-Reel		
No.	FJ008-D-R-S1-1.0		
SCALE		QTY.	4,000
UNIT	mm		
Seiko Instruments Inc.			



No. FT008-A-P-SD-1.1

TITLE	TSSOP8-E-PKG Dimensions
No.	FT008-A-P-SD-1.1
SCALE	
UNIT	mm
Seiko Instruments Inc.	



No. FT008-E-C-SD-1.0

TITLE	TSSOP8-E-Carrier Tape
No.	FT008-E-C-SD-1.0
SCALE	
UNIT	mm
Seiko Instruments Inc.	



Enlarged drawing in the central part

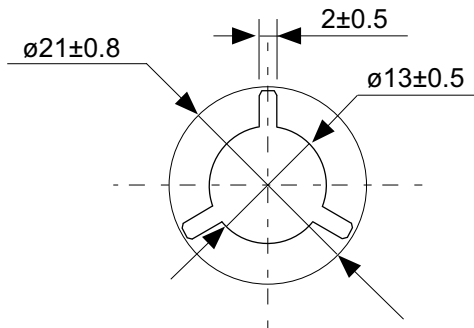

No. FT008-E-R-SD-1.0

TITLE	TSSOP8-E-Reel		
No.	FT008-E-R-SD-1.0		
SCALE		QTY.	3,000
UNIT	mm		
Seiko Instruments Inc.			

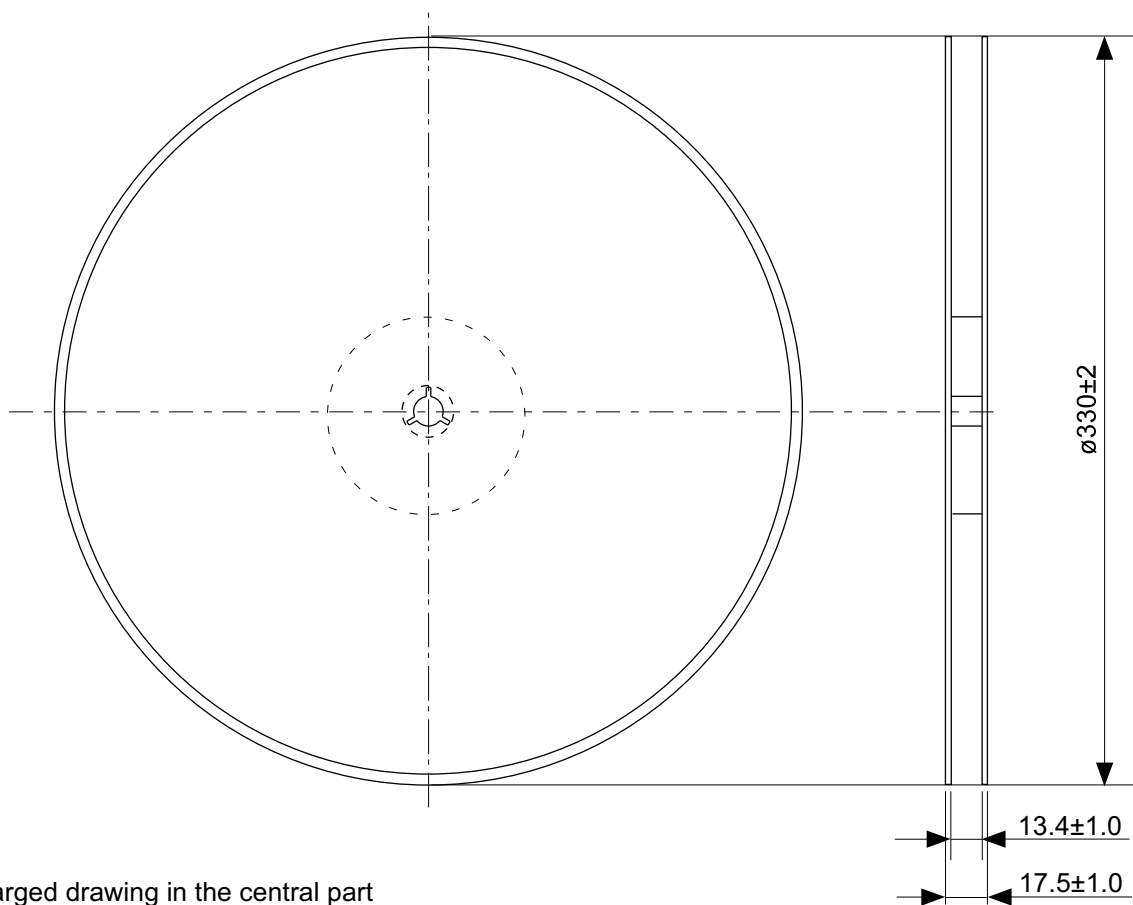

Enlarged drawing in the central part



No. FT008-E-R-S1-1.0

TITLE	TSSOP8-E-Reel		
No.	FT008-E-R-S1-1.0		
SCALE		QTY.	4,000
UNIT	mm		
Seiko Instruments Inc.			



No. PH008-A-P-SD-2.0

TITLE	SNT-8A-A-PKG Dimensions
No.	PH008-A-P-SD-2.0
SCALE	
UNIT	mm
Seiko Instruments Inc.	



Feed direction

No. PH008-A-C-SD-1.0

TITLE	SNT-8A-A-Carrier Tape
No.	PH008-A-C-SD-1.0
SCALE	
UNIT	mm
Seiko Instruments Inc.	



Enlarged drawing in the central part



No. PH008-A-R-SD-1.0

TITLE	SNT-8A-A-Reel		
No.	PH008-A-R-SD-1.0		
SCALE		QTY.	5,000
UNIT	mm		
Seiko Instruments Inc.			



Caution Making the wire pattern under the package is possible. However, note that the package may be upraised due to the thickness made by the silk screen printing and of a solder resist on the pattern because this package does not have the standoff.

注意 パッケージ下への配線パターン形成は可能ですが、本パッケージはスタンドオフが無いので、パターン上のレジスト厚み、シルク印刷の厚みによってパッケージが持ち上がる場合がありますのでご配慮ください。

No. PH008-A-L-SD-3.0

TITLE	SNT-8A-A-Land Recommendation
No.	PH008-A-L-SD-3.0
SCALE	
UNIT	mm
Seiko Instruments Inc.	



No. FM008-A-P-SD-1.0

TITLE	TMSOP8-A-PKG Dimensions
No.	FM008-A-P-SD-1.0
SCALE	
UNIT	mm
Seiko Instruments Inc.	



No. FM008-A-C-SD-1.0

TITLE	TMSOP8-A-Carrier Tape
No.	FM008-A-C-SD-1.0
SCALE	
UNIT	mm
Seiko Instruments Inc.	



Enlarged drawing in the central part



No. FM008-A-R-SD-1.0

TITLE	TMSOP8-A-Reel		
No.	FM008-A-R-SD-1.0		
SCALE		QTY.	4,000
UNIT	mm		
Seiko Instruments Inc.			



Seiko Instruments Inc.
www.sii-ic.com

- The information described herein is subject to change without notice.
- Seiko Instruments Inc. is not responsible for any problems caused by circuits or diagrams described herein whose related industrial properties, patents, or other rights belong to third parties. The application circuit examples explain typical applications of the products, and do not guarantee the success of any specific mass-production design.
- When the products described herein are regulated products subject to the Wassenaar Arrangement or other agreements, they may not be exported without authorization from the appropriate governmental authority.
- Use of the information described herein for other purposes and/or reproduction or copying without the express permission of Seiko Instruments Inc. is strictly prohibited.
- The products described herein cannot be used as part of any device or equipment affecting the human body, such as exercise equipment, medical equipment, security systems, gas equipment, or any apparatus installed in airplanes and other vehicles, without prior written permission of Seiko Instruments Inc.
- Although Seiko Instruments Inc. exerts the greatest possible effort to ensure high quality and reliability, the failure or malfunction of semiconductor products may occur. The user of these products should therefore give thorough consideration to safety design, including redundancy, fire-prevention measures, and malfunction prevention, to prevent any accidents, fires, or community damage that may ensue.

Компания «Life Electronics» занимается поставками электронных компонентов импортного и отечественного производства от производителей и со складов крупных дистрибьюторов Европы, Америки и Азии.

С конца 2013 года компания активно расширяет линейку поставок компонентов по направлению коаксиальный кабель, кварцевые генераторы и конденсаторы (керамические, пленочные, электролитические), за счёт заключения дистрибьюторских договоров

Мы предлагаем:

- Конкурентоспособные цены и скидки постоянным клиентам.
- Специальные условия для постоянных клиентов.
- Подбор аналогов.
- Поставку компонентов в любых объемах, удовлетворяющих вашим потребностям.
- Приемлемые сроки поставки, возможна ускоренная поставка.
- Доставку товара в любую точку России и стран СНГ.
- Комплексную поставку.
- Работу по проектам и поставку образцов.
- Формирование склада под заказчика.
- Сертификаты соответствия на поставляемую продукцию (по желанию клиента).
- Тестирование поставляемой продукции.
- Поставку компонентов, требующих военную и космическую приемку.
- Входной контроль качества.
- Наличие сертификата ISO.

В составе нашей компании организован Конструкторский отдел, призванный помогать разработчикам, и инженерам.

Конструкторский отдел помогает осуществить:

- Регистрацию проекта у производителя компонентов.
- Техническую поддержку проекта.
- Защиту от снятия компонента с производства.
- Оценку стоимости проекта по компонентам.
- Изготовление тестовой платы монтаж и пусконаладочные работы.



Тел: +7 (812) 336 43 04 (многоканальный)
Email: org@lifeelectronics.ru