

Amphenol

the ultimate connection



SCE Series Interconnect Solutions



For more information call **210 372 0631**
Amphenol PCD mhands@amphenolpcd.com

SCE

Snatch Connector Electrical Series The Ultimate Connector Series



SCE is a miniature product with a silent push to mate and pull to release design across two styles of cable receptacles. All inserts and contacts are moulded in place, achieving high environmental sealing to IP68. The metalwork is machined from brass, giving an increased number of mating cycles over traditional aluminium connectors.

The snatch push pull design is fully grounded and cannot be locked when mated, as the cable receptacle has no moving parts, i.e. coupling nut, thus eliminating the path for the ingress of moisture and dust to the interface. The latch push pull design can be non-grounded or grounded and is locked when mated by rotating the coupling nut fitted to the cable receptacle by 30°. This coupling mechanism locks the connectors together, ensuring that they cannot be inadvertently demated. Both are fitted with internal and external o-rings for sealing.

The chassis mounting plug remains unchanged to allow the user to select either a snatch or latch cable receptacle without changing the equipment interface.

Scoop proof shell to shell keying is provided with five different key options of A, B, C, D and N positions, to prevent mis-mating between shells of different operations.

Amphenol offers full cable harness solutions with overmoulding capabilities or, where preferred, a heat shrink boot can be used.



SCE Terminology



SCE Mating Options



Chassis Mount Plug remains same to mate with Snatch or Latch Receptacle

SCE Performance Information

| INSERT AVAILABILITY | |
|---------------------|---|
| 06-05 | 5 #22 AWG Contacts |
| 06-06 | 6 #22 AWG Contacts |
| 06-07 | 7 #22 AWG Contacts |
| 07-10A | 8 #22 AWG Contacts and 2 #16 AWG Contacts |
| 07-12 | 12 #22 AWG Contacts |
| 07-14 | 14 #22 AWG Contacts |
| 08-19 | 19 #22 AWG Contacts |

| CONTACT SPECIFICATIONS | | |
|-----------------------------|----------------|-----------------|
| Contact Resistance | 5 mΩ initially | Less than 10 mΩ |
| Shell to Shell Conductivity | 5 mΩ initially | Less than 10 mΩ |

| INSERT SPECIFICATIONS | |
|--|-------------------|
| Working Voltage (Sea Level) | 115 Vac |
| DWV (Sea Level) | 500 Vac |
| Insulation Resistance (Sea Level) | 1GΩ @ 500 Vdc |
| Current Rating (Individual Contact) | 3A #22 / 7.5A #16 |
| Current Rating (all Contacts simultaneously) | 1A #22 / 5A #16 |

| ENVIRONMENTAL | |
|-----------------------|--|
| Temperature | -55°C / +200°C |
| Salt Spray Resistance | 500 hours |
| Fluids | As per MIL-C-26482 Series I |
| Vibration and Shock | As per MIL-C-26482 Series I |
| IP Rating | IP68 through Unmated Bulkhead Connectors |
| | IP68 Mated Pair Interface |
| Sand and Dust | DEF STAN 07-55 (Part 2) Test D1 |
| Icing/Frosting | DEF STAN 07-55 (Part 2) Test B10 |

| MECHANICAL | |
|------------|--|
| Durability | 2000 Matings |
| Materials | Shell : Brass – Standard plating finish Black Silver |
| | Contacts : Turned, Gold Plated |
| | Inserts and Seal : Proprietary Thermoplastic Polyester Elastomer |

SCE Insert Availability – Shell Size 06

RECEPTACLES – PIN CONTACTS ONLY

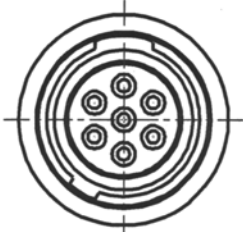

FRONT FACE VIEW
SCE 7 WAY

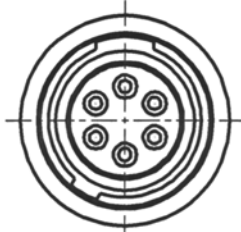

FRONT FACE VIEW
SCE 6 WAY

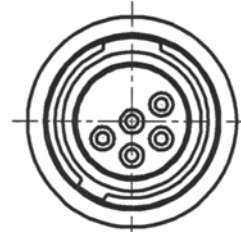

FRONT FACE VIEW
SCE 5 WAY



REAR FACE VIEW
SCE 7 WAY



REAR FACE VIEW
SCE 6 WAY

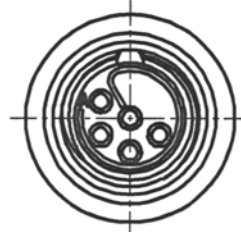

REAR FACE VIEW
SCE 5 WAY

PLUGS – SOCKET CONTACTS ONLY



FRONT FACE VIEW
SCE 7 WAY



FRONT FACE VIEW
SCE 6 WAY



FRONT FACE VIEW
SCE 5 WAY



REAR FACE VIEW
SCE 7 WAY



REAR FACE VIEW
SCE 6 WAY



REAR FACE VIEW
SCE 5 WAY

SCE Insert Availability – Shell Size 07

RECEPTACLES – PIN SOCKETS ONLY



FRONT FACE VIEW
10 WAY



FRONT FACE VIEW
12 WAY

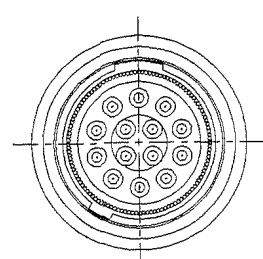

FRONT FACE VIEW
14 WAY



REAR FACE VIEW
10 WAY



REAR FACE VIEW
12 WAY

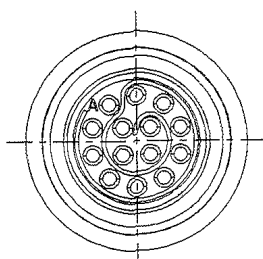

REAR FACE VIEW
14 WAY

PLUGS – SOCKET CONTACTS ONLY



FRONT FACE VIEW
10A WAY



FRONT FACE VIEW
12 WAY

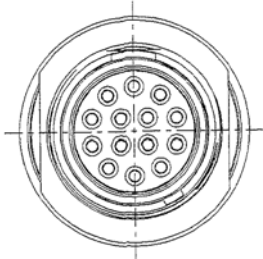

FRONT FACE VIEW
14 WAY



REAR FACE VIEW
10A WAY



REAR FACE VIEW
12 WAY

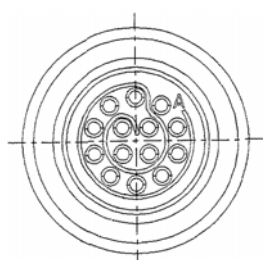

REAR FACE VIEW
14 WAY

SCE Insert Availability – Shell Size 08

RECEPTACLES – PIN CONTACTS ONLY



FRONT FACE VIEW
19 WAY



REAR FACE VIEW
19 WAY

PLUGS – SOCKET CONTACTS ONLY



FRONT FACE VIEW
19 WAY

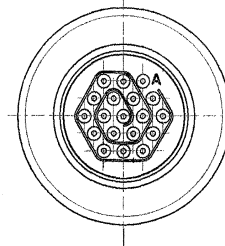

REAR FACE VIEW
19 WAY

SCE Keyway Orientation

| Part Number | Keyway Position | AA' |
|-----------------------|-----------------|-----|
| SCE-B-76A**-**SN-**** | NORMAL | 180 |
| SCE-B-76A**-**SA-**** | A | 150 |
| SCE-B-76A**-**SB-*** | B | 210 |
| SCE-B-76A**-**SC-*** | C | 120 |
| SCE-B-76A**-**SD-*** | D | 240 |

| Part Number | Keyway Position | AA' |
|------------------|-----------------|-----|
| SCE-B-01K**-**PN | NORMAL | 180 |
| SCE-B-01K**-**PA | A | 150 |
| SCE-B-01K**-**PB | B | 210 |
| SCE-B-01K**-**PC | C | 120 |
| SCE-B-01K**-**PD | D | 240 |

| Part Number | Keyway Position | AA' |
|------------------|-----------------|-----|
| SCE-B-06K**-**PN | NORMAL | 180 |
| SCE-B-06K**-**PA | A | 150 |
| SCE-B-06K**-**PB | B | 210 |
| SCE-B-06K**-**PC | C | 120 |
| SCE-B-06K**-**PD | D | 240 |

| Part Number | Keyway Position | AA' |
|------------------|-----------------|-----|
| SCE-B-L1K**-**PN | NORMAL | 180 |
| SCE-B-L1K**-**PA | A | 150 |
| SCE-B-L1K**-**PB | B | 210 |
| SCE-B-L1K**-**PC | C | 120 |
| SCE-B-L1K**-**PD | D | 240 |

SCE Table of Styles – Up to 7 Ways

SCE-B-01T06-XXPX-003
In Line Receptacle
Solder Bucket Contacts



SCE-B-01K06-XXPX
Snatch In Line Receptacle
Integral Backshell
Shell Size 06

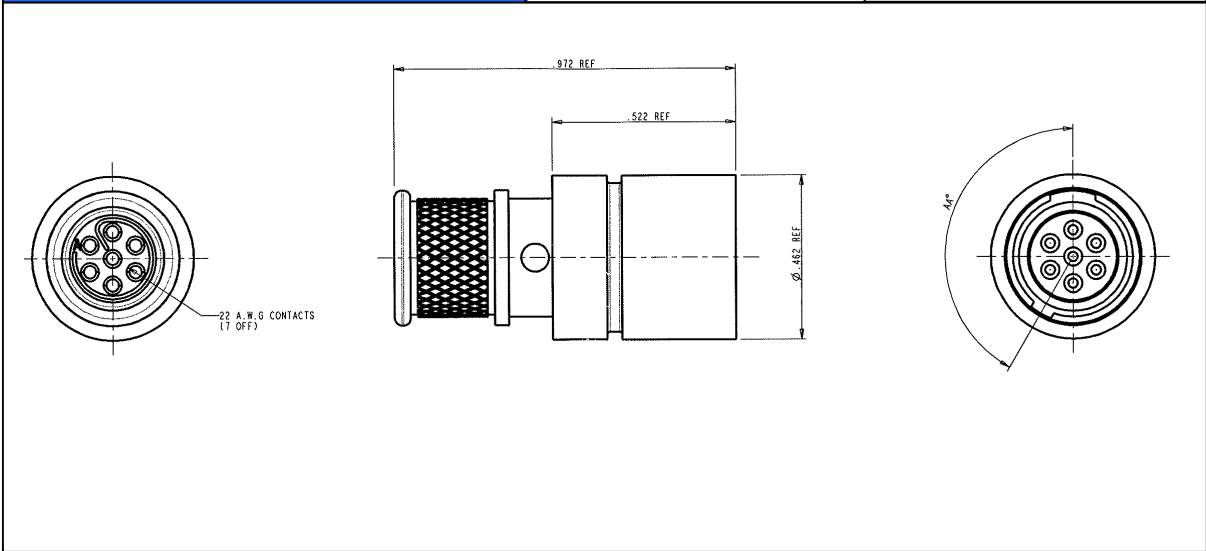
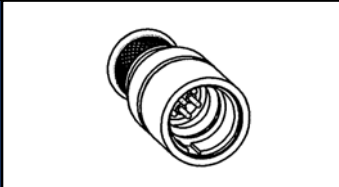

SCE Table of Styles – Up to 7 Ways

SCE-B-L1K06-XXPX
Latch In Line Receptacle
Integral Backshell,
Non-Grounded (Shell Size 06)



390-5016-XXX Receptacle Dust Cap and Cord Will suit Snatch and Latch Shell Size 06



| PART NO. | SUPPLY WITH |
|-----------------|-------------------------------|
| 390-5016-XXX-01 | NO EYELET NO CRIMP FERRULE |
| 390-5016-XXX-02 | CRIMP FERRULE NO EYELET |
| 390-5016-XXX-03 | EYELET NO CRIMP FERRULE |

PART NUMBER



SCE Table of Styles – Up to 14 Ways

SCE-B-01K07-XXPX
Snatch In Line Receptacle
Integral Backshell
Shell Size 07



SCE-B-L1K07-XXPX
Latch In Line Receptacle
Integral Backshell, Non Grounded
Shell Size 07



SCE Table of Styles

390-5020-XXX-XX(771)

Receptacle Dust Cap and Cord
Will suit Snatch and Latch
Shell Size 07

Cord is Black
 Eyelet and Crimp Ferrule Black Zinc Cobalt



| PART NUMBER | SUPPLY WITH |
|-----------------------|-------------------------------|
| 390-5020-XXX-01 (771) | NO EYELET NO CRIMP FERRULE |
| 390-5020-XXX-02 (771) | CRIMP FERRULE NO EYELET |
| 390-5020-XXX-03 (771) | EYELET NO CRIMP FERRULE |



SCE Table of Styles – Up to 19 Ways

SCE-B-L1K08-XXPX
Latch In Line Receptacle
Integral Backshell, Non-Grounded
Shell Size 08





SOLDER BUCKETS WILL ACCEPT 22 A.W.G. WIRE MAX

For Grounded Latch connector, please add (985) to the end of part number

390-5022-XXX-XX(771)
Receptacle Dust Cap and Cord
Will suit Snatch and Latch
Shell Size 08

Cord is Black
Eyelet and Crimp Ferrule Black Zinc Cobalt



| PART NUMBER | SUPPLY WITH |
|-----------------------|-------------------------------|
| 390-5022-XXX-01 (771) | NO EYELET NO CRIMP FERRULE |
| 390-5022-XXX-02 (771) | CRIMP FERRULE NO EYELET |
| 390-5022-XXX-03 (771) | EYELET NO CRIMP FERRULE |

PART NUMBER BREAKDOWN

390 - 5020 - XXX - XX (771)

- SERIES ————— 390
- STYLE ————— 5020
- CAP FOR SCE RECEPTACLE ————— XXX
- SIZE 07 ————— XX
- PLATING DEVIATION – BLACK ZINC COBALT ————— (771)
- CRIMP/EYELET OPTION – SEE TABLE 1
- CORD LENGTH IN MILLIMETRES

SCE Table of Styles

SCE-B-07A06-XXPX-001

**Jam Nut Rear Mount Receptacles
PCB Contacts**



SCE-B-07A06-XXPX-002

**Jam Nut Rear Mount Receptacles
Solder Bucket Contacts**



SCE Table of Styles

SCE-B-17A06-XXPX-001

**Jam Nut Front Mount Receptacles
PCB Contacts**

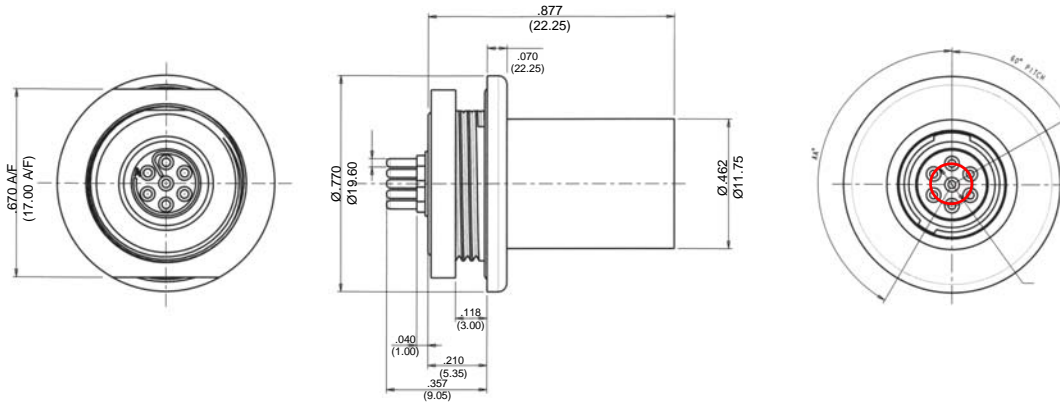

SCE-B-17A06-XXPX-002

**Jam Nut Front Mount Receptacles
Solder Bucket Contacts**



SCE Table of Styles

SCE-B-20A06-XXPX-001

**2 Hole Mount Receptacle
PCB Contacts**



SCE-B-20A06-XXPX-002

**2 Hole Mount Receptacle
Solder Bucket Contacts**



SCE Table of Styles

SCE-B-00A06-XXPX-001

**4 Hole Mount Receptacle
PCB Contacts**



SCE-B-00A06-XXPX-002

**4 Hole Mount Receptacle
Solder Bucket Contacts**



Panel Mounting Details – Shell Size 06

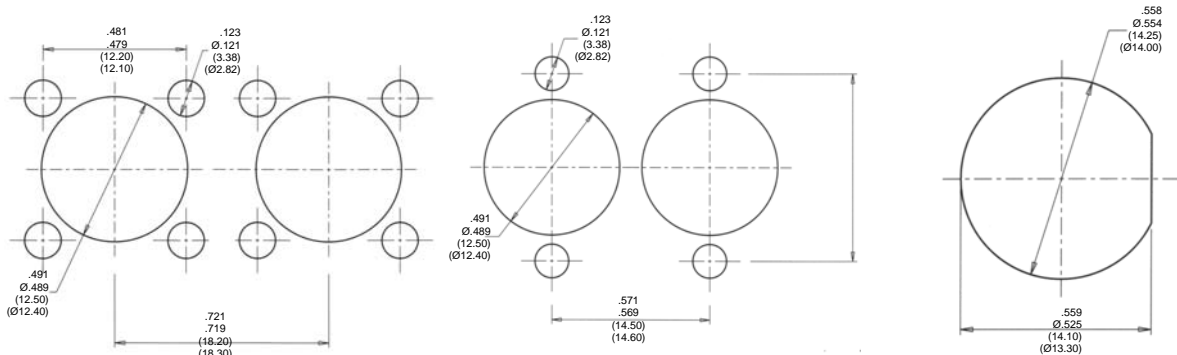

SCE Table of Styles

390-0120-01

**2 Hole Gasket
for 2 Hole Mount Plug**



390-0121-01

**4 Hole Gasket
for 4 Hole Mount Plug**



SCE Table of Styles

20GB-SCE-6XXX-XXX Front Mount Jam Nut Receptacle to Header Assembly

LENGTH IN MM XXX – SEE TABLE

MATING HALF CONNECTOR
RS-311-6546

P1 P2

| VARIANT | LENGTH XXX |
|---------|------------|
| 025 | 25MM |
| 050 | 50MM |
| 075 | 75MM |
| 100 | 100MM |
| 125 | 125MM |
| 150 | 150MM |

WIRING SCHEDULE

Please contact Amphenol for full part numbering information

Panel Nut - Torque to 2.25Nm = 1.65 foot pounds force

20GB-SCE-6XXX-XXX Rear Mount Jam Nut Receptacle to Header Assembly

LENGTH IN MM XXX – SEE TABLE

MATING HALF CONNECTOR
RS-311-6546

P1 P2

| VARIANT | LENGTH XXX |
|---------|------------|
| 025 | 25MM |
| 050 | 50MM |
| 075 | 75MM |
| 100 | 100MM |
| 125 | 125MM |
| 150 | 150MM |

WIRING SCHEDULE

Please contact Amphenol for full part numbering information

Panel Nut - Torque to 2.25Nm = 1.65 foot pounds force

SCE Table of Styles – Up to 7 Ways

SCE-X-76A06-XXSX-001
Rear Mount Plug
PCB Contacts



SCE-X-76A06-XXSX-002
Rear Mount Plug
Solder Bucket Contacts

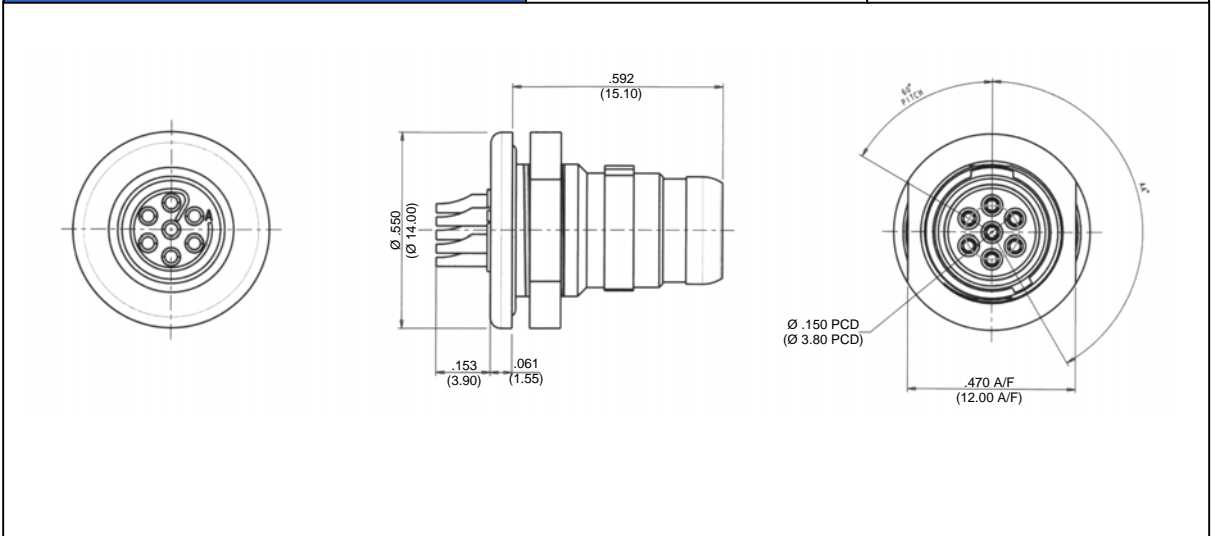

SCE Table of Styles – Up to 14 Ways

SCE-B-76A07-XXSX-001

**Jam Nut Front Mount Plug
PCB Bucket Contacts**

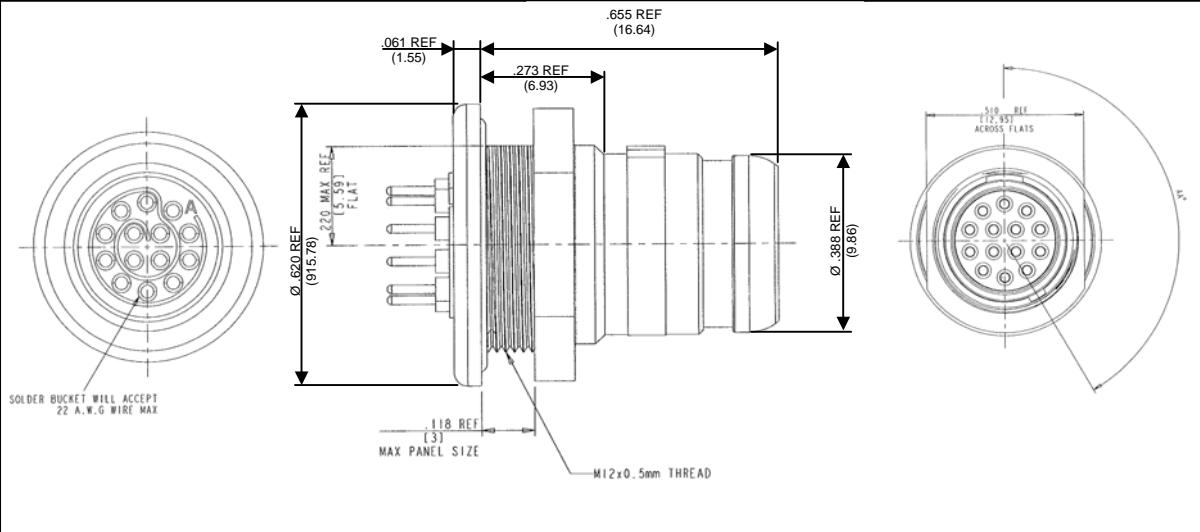

SCE-B-76A07-XXSX-002

**Jam Nut Front Mount Plug
Solder Bucket Contacts**

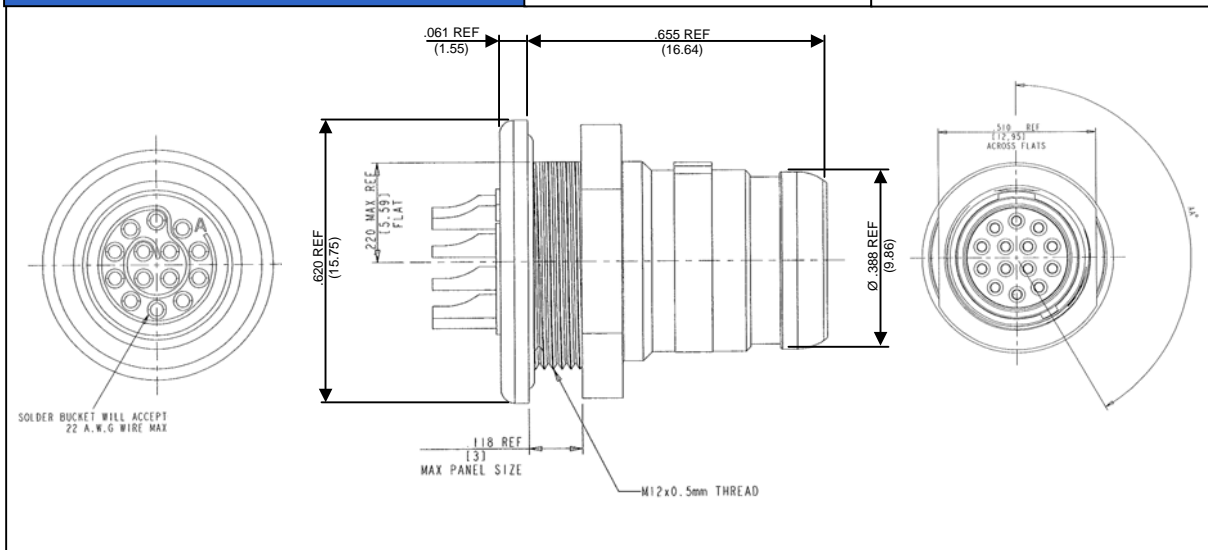

SCE Table of Styles – Up to 19 Ways

SCE-B-76A08-19SX-001
Jam Nut Front Mount Plug
PCB Bucket Contacts

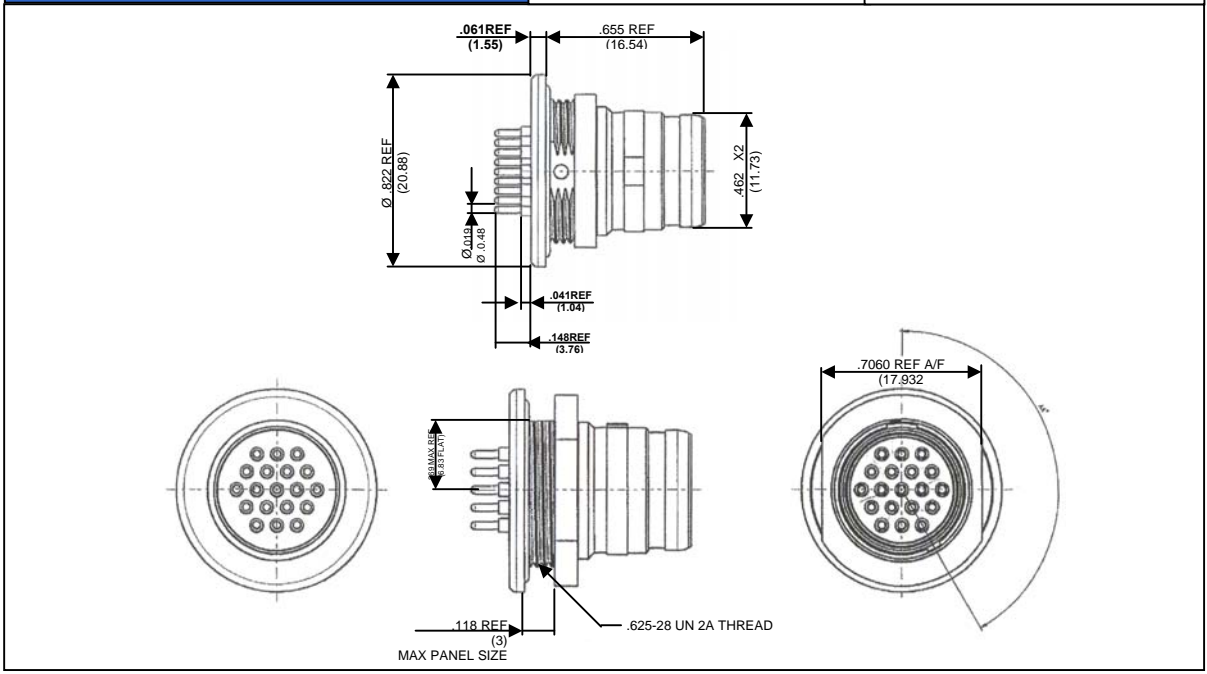
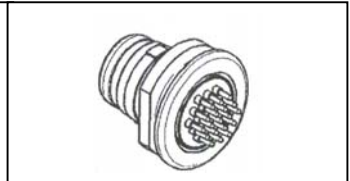
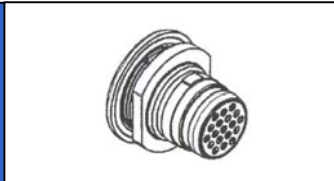

SCE-B-76A08-19SX-002
Jam Nut Front Mount Plug
Solder Bucket Contacts

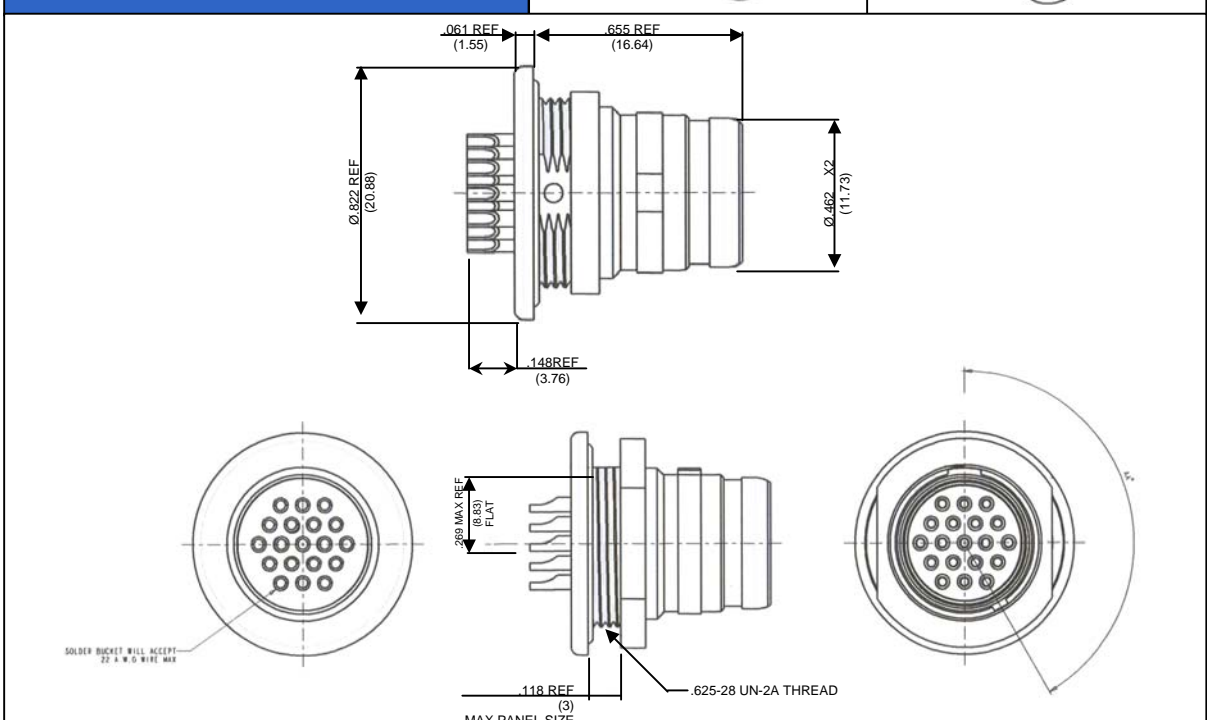
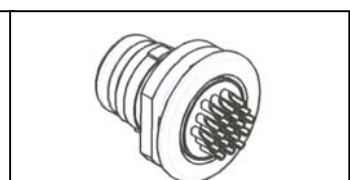
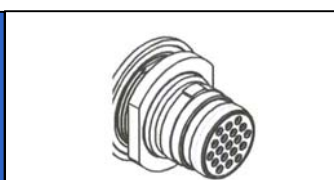

SCE Table of Styles – Up to 7 Ways

SCE-X-06T06-XXSX-003

**In Line Plug
Solder Bucket Contacts only
(complete with Backshell)**



SCE-B-06K06-XXPX

**In Line Plug
Integral Backshell, Solder Bucket Contacts
Shell Size 06**



SCE Table of Styles – Up to 7 Ways

SCE-X-67A06-XXSX-001

**Front Mount Plug
PCB Contacts**

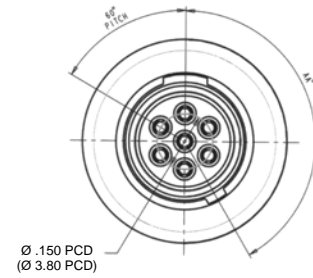

SCE-X-67A06-XXSX-002

**Front Mount Plug
Solder Bucket Contacts**



SCE Table of Styles

390-0088-130-XX Plug Dust Cap and Cord Will suit Plugs Shell Size 06

PART NUMBER INFORMATION

390 - 0088 - 130 - XX

SERIES ————— 390

STYLE – PROTECTIVE CAP FOR SCE PLUG ————— 0088

CORD LENGTH (in mm) ————— 130

CRIMP/EYELET ————— XX

| PART NO. | SUPPLY WITH |
|-----------------|-------------------------------|
| 390-0088-XXX-01 | NO EYELET NO CRIMP FERRULE |
| 390-0088-XXX-02 | CRIMP FERRULE NO EYELET |
| 390-0088-XXX-03 | EYELET NO CRIMP FERRULE |

390-5019-XXX-XX(771) Receptacle Dust Cap and Cord Will suit Snatch and Latch Shell Size 07

Cord is Black
Eyelet and crimp ferrule black zinc cobalt

| PART NO | SUPPLY WITH |
|----------------------|--------------------------------|
| 390-5019-XXX-01(771) | NO EYELETS NO CRIMP FERRULE |
| 390-5019-XXX-02(771) | CRIMP FERRULE NO EYELET |
| 390-5019-XXX-03(771) | EYELET NO CRIMP FERRULE |

Heatshrink Boots

100 Series – Bottle Shapes with Rib – MIL Style

For use with SCE-06T and SCE-01T

We have selected Heatshrink Boots from Hellermann Tyton. Heatshrink Boots from other manufacturers may be used if appropriate.



This style is used in conjunction with the backshell (see page 13) providing strain relief and environmental sealing

Dimensions apply to all materials unless otherwise indicated

| Hellermann Part No | Expanded (Min) | | | | Recovered (Max) | | Recovered Dimensions Fully Shrunk | | | | | |
|--------------------|------------------|------------------|------------------|------------------|-----------------|-----------------|-----------------------------------|------------------|-----------------|-----------------|-----------------|-----------------|
| | H | H -H matl | JØ | J -H matl | H | JØ | P ±10% | R ±10% | Jo ±10% | HW ±10% | JW ±10% | T ±10% |
| 113-4-G-WM250 | 0.3976 (10.7) | 0.3976 (10.7) | 0.1811 (4.6) | 0.1811 (4.6) | 0.3110 (7.9) | 0.0787 (2.0) | 1.0 (25.4) | 0.5709 (14.5) | 0.1811 (4.6) | 0.0512 (1.3) | 0.0512 (1.3) | 0.0394 (1.0) |
| 104-4-G-WM250 | 0.6456 (16.4) | 0.6456 (16.4) | 0.6456 (16.4) | 0.6456 (16.4) | 0.3110 (7.9) | 0.149 (3.8) | 1.0 (25.4) | 0.5590 (14.2) | 0.2716 (6.9) | 0.0512 (1.3) | 0.0512 (1.3) | 0.0394 (1.0) |

1100 Series – Right Angle Shapes with Rib – MIL Style



The style provides strain relief for harness systems when used in conjunction with the backshell (see page 13)

Dimensions apply to all materials unless otherwise indicated

| Hellermann Part No | Expanded (Min) | | Recovered (Max) | | Recovered Dimensions Fully Shrunk | | | | | |
|--------------------|------------------|------------------|-------------------|-----------------|-----------------------------------|------------------|------------------|-----------------|-----------------|-----------------|
| | H | JØ | H | JØ | P ±10% | R ±10% | S ±10% | Jo ±10% | W ±20% | T ±20% |
| 1108-4-G-WM250 | 0.6496 (16.5) | 0.6496 (16.5) | 0.3110 (7.9) | 0.1496 (3.8) | 0.6875 (17.3) | 0.7969 (20.1) | 0.6005 (15.2) | 0.1614 (4.1) | 0.0394 (1.0) | 0.0394 (1.0) |
| 1106-4-G-WM250 | 0.9173 (23.3) | 0.9173 (23.3) | 0.4094 (10.04) | 0.2204 (5.6) | 0.7992 (20.3) | 0.9015 (22.9) | 0.6005 (15.2) | 0.2283 (5.8) | 0.0511 (1.3) | 0.0394 (1.0) |

SCE Plug to Header Cable Assemblies

20GB-SCE-6XXX-XXX Jam Nut Plug Rear Mount to Header Assembly – Solder Bucket Contacts only



| VARIANT | LENGTH |
|---------|--------|
| 025 | 25MM |
| 050 | 50MM |
| 075 | 75MM |
| 100 | 100MM |
| 125 | 125MM |
| 150 | 150MM |



Panel Nut - Torque to 2.25Nm = 1.65 foot lbs force

Please contact Amphenol for full part numbering information

20GB- SCE-6XXX-XXX Jam Nut Plug Front Mount to Header Assembly – Solder Bucket Contacts only



| VARIANT | LENGTH |
|---------|--------|
| 025 | 25MM |
| 050 | 50MM |
| 075 | 75MM |
| 100 | 100MM |
| 125 | 125MM |
| 150 | 150MM |



Panel Nut - Torque to 2.25Nm = 1.65 foot lbs force

Please contact Amphenol for full part numbering information

SCE - Cable Assemblies

Amphenol can supply complete overmoulded cable harness solutions to your specifications. Please consult factory for cable number allocation.

Up to 7 Way Single-Ended Receptacle Cable Assembly



NOTES:

1. THE MAIN KEY OF THE CONNECTOR IS TO BE IN LINE WITH THE LOCATION RIB ON THE OVERMOULD
2. ALL DIMENSIONS ARE FOR REFERENCE ONLY
3. XXX.X IN PART NUMBER DENOTES CABLE LENGTH IN METRES E.G. 5.5M = 005.5

PART NUMBER INFORMATION



All Dimensions are for reference only
(Dimensions in brackets are in mm)

Up to 7 Way Double-Ended Receptacle to Receptacle Cable Assembly

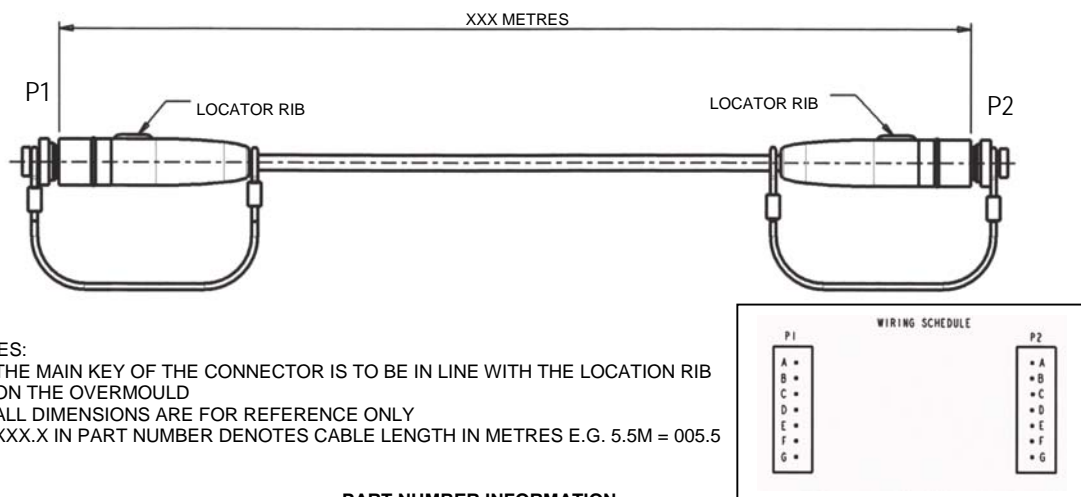

NOTES:

1. THE MAIN KEY OF THE CONNECTOR IS TO BE IN LINE WITH THE LOCATION RIB ON THE OVERMOULD
2. ALL DIMENSIONS ARE FOR REFERENCE ONLY
3. XXX.X IN PART NUMBER DENOTES CABLE LENGTH IN METRES E.G. 5.5M = 005.5

PART NUMBER INFORMATION



SCE - Cable Assemblies

Up to 7 Way Single-Ended Receptacle Coiled Cable Assembly



NOTES:

1. THE MAIN KEY OF THE CONNECTOR IS TO BE IN LINE WITH THE LOCATION RIB ON THE OVERMOULD
2. ALL DIMENSIONS ARE FOR REFERENCE ONLY
3. XXX.X IN PART NUMBER DENOTES CABLE LENGTH IN METRES E.G. 5.5M = 005.5

PART NUMBER INFORMATION



All Dimensions are for reference only
(Dimensions in brackets are in mm)

Up to 7 Way Double-Ended Receptacle to Receptacle Coiled Cable Assembly



NOTES:

1. THE MAIN KEY OF THE CONNECTOR IS TO BE IN LINE WITH THE LOCATION RIB ON THE OVERMOULD
2. ALL DIMENSIONS ARE FOR REFERENCE ONLY
3. XXX.X IN PART NUMBER DENOTES CABLE LENGTH IN METRES E.G. 5.5M = 005.5

PART NUMBER INFORMATION



SCE Connector Part Numbers – Receptacles only



* Please consult factory.

Note: If ordering 01K and L1K receptacles, please omit the cable variant from the part number.

SCE Connector Part Numbers – Plugs only



* Please consult factory.

Note: For castellated panel nut, please add (981) at the end of plug part number

SCE Crimp Tool

For Braid Termination Style 003

Crimp the Braid into place so that the ferrule butts up against the shoulder of the backshell. Use crimp tool Daniels HX4 M22520/5-01 handle, crimp die set Daniels Y530 CAGE 11851 at setting 180.



July 2006

Notice: Products are sold subject to Amphenol's Standard Conditions of Sale. All specifications and statements contained herein are believed to be correct at the time of printing but no representation or warranty, express or implied, is given as to any specification or statement contained herein. Product specifications including performance characteristics are typical only and subject to deviation. Specifications are also subject to change without notice. Users should not assume that all safety measures are indicated or that other measures may not be required. No representation or warranty, express or implied, is given that any use of products (including any stated or suggested use) does not infringe any patent, registered design or other third party rights and no stated or suggested use of products can be taken to recommend any such infringement.

Amphenol PCD

72 Cherry Hill Rd, Beverly, MA 01915, USA Tel: 978-624-3400

Компания «Life Electronics» занимается поставками электронных компонентов импортного и отечественного производства от производителей и со складов крупных дистрибьюторов Европы, Америки и Азии.

С конца 2013 года компания активно расширяет линейку поставок компонентов по направлению коаксиальный кабель, кварцевые генераторы и конденсаторы (керамические, пленочные, электролитические), за счёт заключения дистрибьюторских договоров

Мы предлагаем:

- Конкурентоспособные цены и скидки постоянным клиентам.
- Специальные условия для постоянных клиентов.
- Подбор аналогов.
- Поставку компонентов в любых объемах, удовлетворяющих вашим потребностям.
- Приемлемые сроки поставки, возможна ускоренная поставка.
- Доставку товара в любую точку России и стран СНГ.
- Комплексную поставку.
- Работу по проектам и поставку образцов.
- Формирование склада под заказчика.
- Сертификаты соответствия на поставляемую продукцию (по желанию клиента).
- Тестирование поставляемой продукции.
- Поставку компонентов, требующих военную и космическую приемку.
- Входной контроль качества.
- Наличие сертификата ISO.

В составе нашей компании организован Конструкторский отдел, призванный помогать разработчикам, и инженерам.

Конструкторский отдел помогает осуществить:

- Регистрацию проекта у производителя компонентов.
- Техническую поддержку проекта.
- Защиту от снятия компонента с производства.
- Оценку стоимости проекта по компонентам.
- Изготовление тестовой платы монтаж и пусконаладочные работы.



Тел: +7 (812) 336 43 04 (многоканальный)
Email: org@lifeelectronics.ru