

# Amphenol

the ultimate connection



## SCE Series Interconnect Solutions



For more information call **210 372 0631**  
Amphenol PCD [mhands@amphenolpcd.com](mailto:mhands@amphenolpcd.com)

## SCE

### Snatch Connector Electrical Series The Ultimate Connector Series



SCE is a miniature product with a silent push to mate and pull to release design across two styles of cable receptacles. All inserts and contacts are moulded in place, achieving high environmental sealing to IP68. The metalwork is machined from brass, giving an increased number of mating cycles over traditional aluminium connectors.

The snatch push pull design is fully grounded and cannot be locked when mated, as the cable receptacle has no moving parts, i.e. coupling nut, thus eliminating the path for the ingress of moisture and dust to the interface. The latch push pull design can be non-grounded or grounded and is locked when mated by rotating the coupling nut fitted to the cable receptacle by 30°. This coupling mechanism locks the connectors together, ensuring that they cannot be inadvertently demated. Both are fitted with internal and external o-rings for sealing.

The chassis mounting plug remains unchanged to allow the user to select either a snatch or latch cable receptacle without changing the equipment interface.

Scoop proof shell to shell keying is provided with five different key options of A, B, C, D and N positions, to prevent mis-mating between shells of different operations.

Amphenol offers full cable harness solutions with overmoulding capabilities or, where preferred, a heat shrink boot can be used.



## SCE Terminology



## SCE Mating Options



**Chassis Mount Plug remains same to mate with Snatch or Latch Receptacle**

## SCE Performance Information

INSERT AVAILABILITY	
06-05	5 #22 AWG Contacts
06-06	6 #22 AWG Contacts
06-07	7 #22 AWG Contacts
07-10A	8 #22 AWG Contacts and 2 #16 AWG Contacts
07-12	12 #22 AWG Contacts
07-14	14 #22 AWG Contacts
08-19	19 #22 AWG Contacts

CONTACT SPECIFICATIONS		
Contact Resistance	5 mΩ initially	Less than 10 mΩ
Shell to Shell Conductivity	5 mΩ initially	Less than 10 mΩ

INSERT SPECIFICATIONS	
Working Voltage (Sea Level)	115 Vac
DWV (Sea Level)	500 Vac
Insulation Resistance (Sea Level)	1GΩ @ 500 Vdc
Current Rating (Individual Contact)	3A #22 / 7.5A #16
Current Rating (all Contacts simultaneously)	1A #22 / 5A #16

ENVIRONMENTAL	
Temperature	-55°C / +200°C
Salt Spray Resistance	500 hours
Fluids	As per MIL-C-26482 Series I
Vibration and Shock	As per MIL-C-26482 Series I
IP Rating	IP68 through Unmated Bulkhead Connectors
	IP68 Mated Pair Interface
Sand and Dust	DEF STAN 07-55 (Part 2) Test D1
Icing/Frosting	DEF STAN 07-55 (Part 2) Test B10

MECHANICAL	
Durability	2000 Matings
Materials	Shell : Brass – Standard plating finish Black Silver
	Contacts : Turned, Gold Plated
	Inserts and Seal : Proprietary Thermoplastic Polyester Elastomer

## SCE Insert Availability – Shell Size 06

### RECEPTACLES – PIN CONTACTS ONLY



FRONT FACE VIEW  
SCE 7 WAY



FRONT FACE VIEW  
SCE 6 WAY

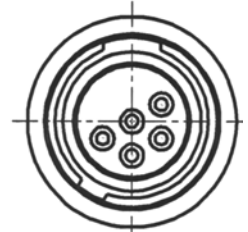

FRONT FACE VIEW  
SCE 5 WAY



REAR FACE VIEW  
SCE 7 WAY



REAR FACE VIEW  
SCE 6 WAY

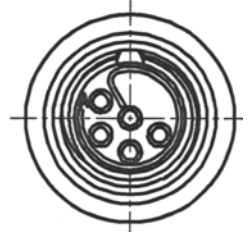

REAR FACE VIEW  
SCE 5 WAY

### PLUGS – SOCKET CONTACTS ONLY



FRONT FACE VIEW  
SCE 7 WAY



FRONT FACE VIEW  
SCE 6 WAY

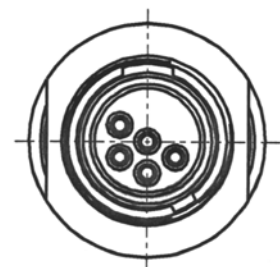

FRONT FACE VIEW  
SCE 5 WAY

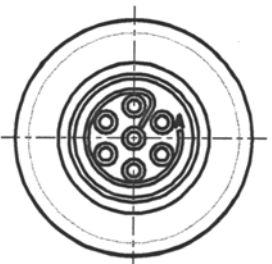

REAR FACE VIEW  
SCE 7 WAY

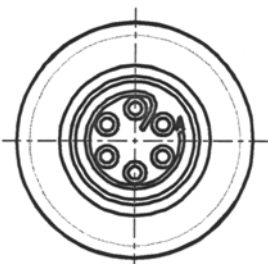

REAR FACE VIEW  
SCE 6 WAY

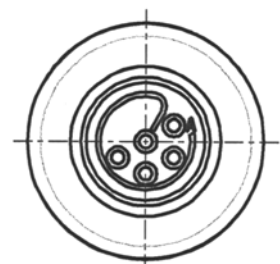

REAR FACE VIEW  
SCE 5 WAY

# SCE Insert Availability – Shell Size 07

## RECEPTACLES – PIN SOCKETS ONLY

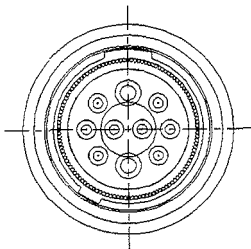

FRONT FACE VIEW  
10 WAY

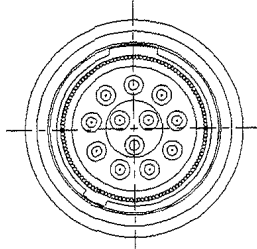

FRONT FACE VIEW  
12 WAY

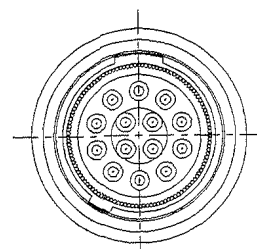

FRONT FACE VIEW  
14 WAY

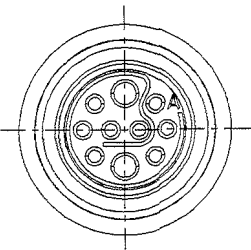

REAR FACE VIEW  
10 WAY

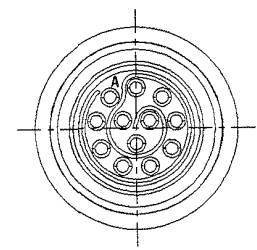

REAR FACE VIEW  
12 WAY

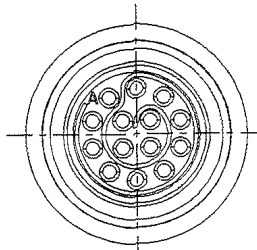

REAR FACE VIEW  
14 WAY

## PLUGS – SOCKET CONTACTS ONLY

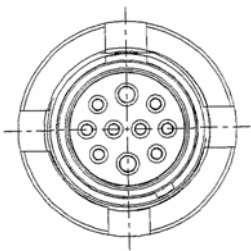

FRONT FACE VIEW  
10A WAY

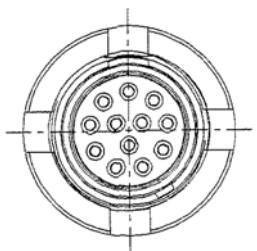

FRONT FACE VIEW  
12 WAY

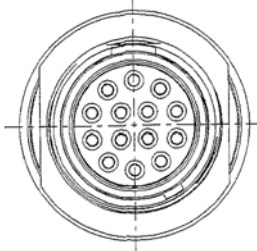

FRONT FACE VIEW  
14 WAY

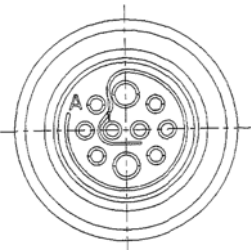

REAR FACE VIEW  
10A WAY

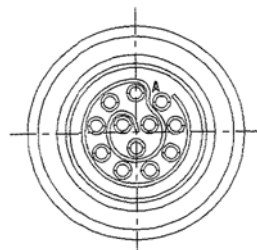

REAR FACE VIEW  
12 WAY

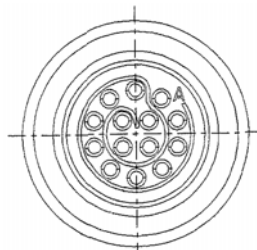

REAR FACE VIEW  
14 WAY

## SCE Insert Availability – Shell Size 08

### RECEPTACLES – PIN CONTACTS ONLY

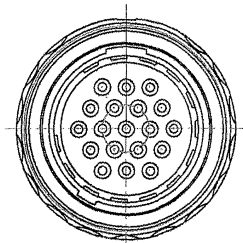

FRONT FACE VIEW  
19 WAY

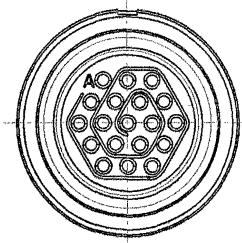

REAR FACE VIEW  
19 WAY

### PLUGS – SOCKET CONTACTS ONLY

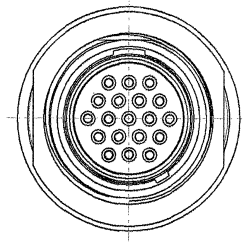

FRONT FACE VIEW  
19 WAY

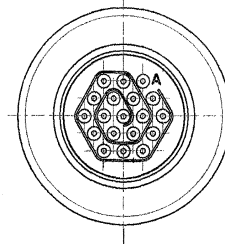

REAR FACE VIEW  
19 WAY

## SCE Keyway Orientation

Part Number	Keyway Position	AA'
SCE-B-76A**-**SN-****	NORMAL	180
SCE-B-76A**-**SA-****	A	150
SCE-B-76A**-**SB-***	B	210
SCE-B-76A**-**SC-***	C	120
SCE-B-76A**-**SD-***	D	240

Part Number	Keyway Position	AA'
SCE-B-01K**-**PN	NORMAL	180
SCE-B-01K**-**PA	A	150
SCE-B-01K**-**PB	B	210
SCE-B-01K**-**PC	C	120
SCE-B-01K**-**PD	D	240

Part Number	Keyway Position	AA'
SCE-B-06K**-**PN	NORMAL	180
SCE-B-06K**-**PA	A	150
SCE-B-06K**-**PB	B	210
SCE-B-06K**-**PC	C	120
SCE-B-06K**-**PD	D	240

Part Number	Keyway Position	AA'
SCE-B-L1K**-**PN	NORMAL	180
SCE-B-L1K**-**PA	A	150
SCE-B-L1K**-**PB	B	210
SCE-B-L1K**-**PC	C	120
SCE-B-L1K**-**PD	D	240

## SCE Table of Styles – Up to 7 Ways

**SCE-B-01T06-XXPX-003**  
**In Line Receptacle**  
**Solder Bucket Contacts**



**SCE-B-01K06-XXPX**  
**Snatch In Line Receptacle**  
**Integral Backshell**  
**Shell Size 06**





## SCE Table of Styles – Up to 7 Ways

**SCE-B-L1K06-XXPX**  
**Latch In Line Receptacle**  
**Integral Backshell,**  
**Non-Grounded (Shell Size 06)**



## 390-5016-XXX Receptacle Dust Cap and Cord Will suit Snatch and Latch Shell Size 06



PART NO.	SUPPLY WITH
390-5016-XXX-01	NO EYELET NO CRIMP FERRULE
390-5016-XXX-02	CRIMP FERRULE NO EYELET
390-5016-XXX-03	EYELET NO CRIMP FERRULE

**PART NUMBER**

390 - 5016 - XXX - XX

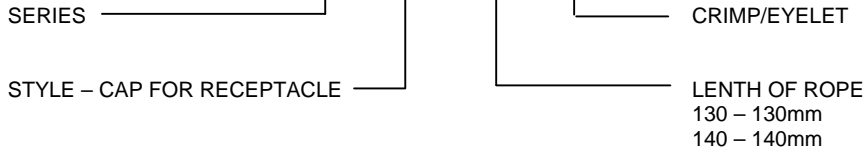

## SCE Table of Styles – Up to 14 Ways

**SCE-B-01K07-XXPX**  
**Snatch In Line Receptacle**  
**Integral Backshell**  
**Shell Size 07**



**SCE-B-L1K07-XXPX**  
**Latch In Line Receptacle**  
**Integral Backshell, Non Grounded**  
**Shell Size 07**



# SCE Table of Styles

**390-5020-XXX-XX(771)**

**Receptacle Dust Cap and Cord**  
**Will suit Snatch and Latch**  
**Shell Size 07**

Cord is Black  
 Eyelet and Crimp Ferrule Black Zinc Cobalt



PART NUMBER	SUPPLY WITH
390-5020-XXX-01 (771)	NO EYELET NO CRIMP FERRULE
390-5020-XXX-02 (771)	CRIMP FERRULE NO EYELET
390-5020-XXX-03 (771)	EYELET NO CRIMP FERRULE



## SCE Table of Styles – Up to 19 Ways

**SCE-B-L1K08-XXPX**  
**Latch In Line Receptacle**  
**Integral Backshell, Non-Grounded**  
**Shell Size 08**





SOLDER BUCKETS WILL ACCEPT 22 A.W.G. WIRE MAX

For Grounded Latch connector, please add (985) to the end of part number

**390-5022-XXX-XX(771)**  
**Receptacle Dust Cap and Cord**  
**Will suit Snatch and Latch**  
**Shell Size 08**

**Cord is Black**  
**Eyelet and Crimp Ferrule Black Zinc Cobalt**



PART NUMBER	SUPPLY WITH
390-5022-XXX-01 (771)	NO EYELET NO CRIMP FERRULE
390-5022-XXX-02 (771)	CRIMP FERRULE NO EYELET
390-5022-XXX-03 (771)	EYELET NO CRIMP FERRULE

**PART NUMBER BREAKDOWN**

390 - 5020 - XXX - XX (771)

- SERIES ————— 390
- STYLE ————— 5020
- CAP FOR SCE RECEPTACLE ————— XXX
- SIZE 07 ————— XX
- PLATING DEVIATION – BLACK ZINC COBALT ————— (771)
- CRIMP/EYELET OPTION – SEE TABLE 1
- CORD LENGTH IN MILLIMETRES

## SCE Table of Styles

**SCE-B-07A06-XXPX-001**

**Jam Nut Rear Mount Receptacles  
PCB Contacts**



**SCE-B-07A06-XXPX-002**

**Jam Nut Rear Mount Receptacles  
Solder Bucket Contacts**



## SCE Table of Styles

**SCE-B-17A06-XXPX-001**

**Jam Nut Front Mount Receptacles  
PCB Contacts**



**SCE-B-17A06-XXPX-002**

**Jam Nut Front Mount Receptacles  
Solder Bucket Contacts**



## SCE Table of Styles

### SCE-B-20A06-XXPX-001

**2 Hole Mount Receptacle  
PCB Contacts**



### SCE-B-20A06-XXPX-002

**2 Hole Mount Receptacle  
Solder Bucket Contacts**



## SCE Table of Styles

### SCE-B-00A06-XXPX-001

**4 Hole Mount Receptacle  
PCB Contacts**

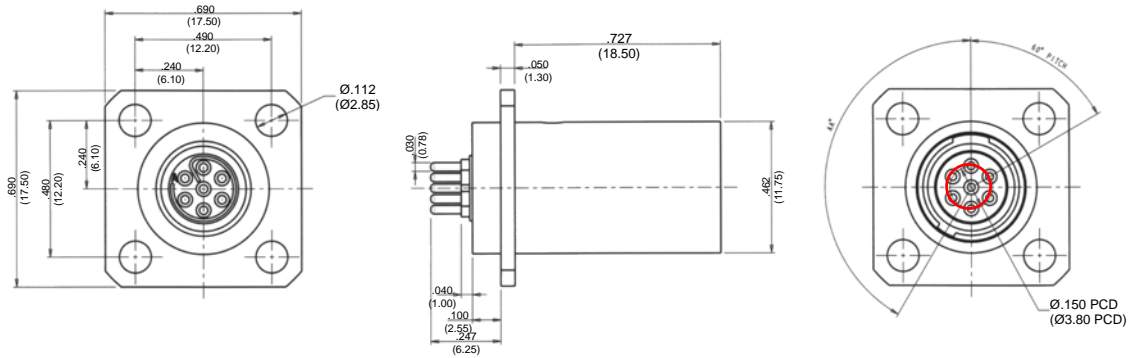

### SCE-B-00A06-XXPX-002

**4 Hole Mount Receptacle  
Solder Bucket Contacts**



### Panel Mounting Details – Shell Size 06







## SCE Table of Styles

### 20GB-SCE-6XXX-XXX Front Mount Jam Nut Receptacle to Header Assembly

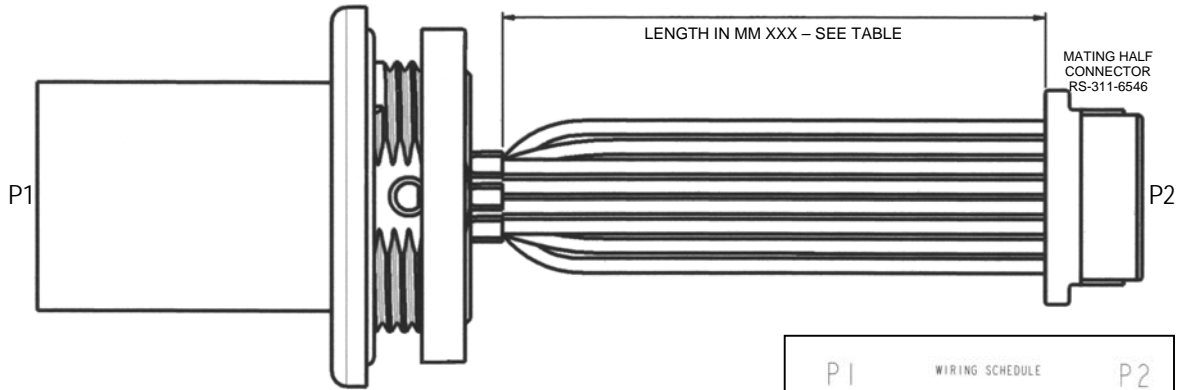

VARIANT	LENGTH XXX
025	25MM
050	50MM
075	75MM
100	100MM
125	125MM
150	150MM

Please contact Amphenol for full part numbering information



Panel Nut - Torque to 2.25Nm = 1.65 foot pounds force

### 20GB-SCE-6XXX-XXX Rear Mount Jam Nut Receptacle to Header Assembly



VARIANT	LENGTH XXX
025	25MM
050	50MM
075	75MM
100	100MM
125	125MM
150	150MM

Please contact Amphenol for full part numbering information



Panel Nut - Torque to 2.25Nm = 1.65 foot pounds force

## SCE Table of Styles – Up to 7 Ways

**SCE-X-76A06-XXSX-001**  
**Rear Mount Plug**  
**PCB Contacts**

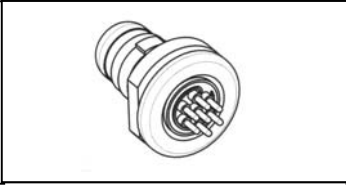

**SCE-X-76A06-XXSX-002**  
**Rear Mount Plug**  
**Solder Bucket Contacts**

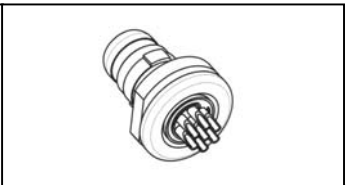

# SCE Table of Styles – Up to 14 Ways

**SCE-B-76A07-XXSX-001**  
**Jam Nut Front Mount Plug**  
**PCB Bucket Contacts**



**SCE-B-76A07-XXSX-002**  
**Jam Nut Front Mount Plug**  
**Solder Bucket Contacts**



# SCE Table of Styles – Up to 19 Ways

**SCE-B-76A08-19SX-001**  
**Jam Nut Front Mount Plug**  
**PCB Bucket Contacts**



**SCE-B-76A08-19SX-002**  
**Jam Nut Front Mount Plug**  
**Solder Bucket Contacts**



## SCE Table of Styles – Up to 7 Ways

<p><b>SCE-X-06T06-XXSX-003</b></p> <p><b>In Line Plug</b>  <b>Solder Bucket Contacts only</b>  <b>(complete with Backshell)</b></p>		
		

<p><b>SCE-B-06K06-XXPX</b></p> <p><b>In Line Plug</b>  <b>Integral Backshell, Solder Bucket Contacts</b>  <b>Shell Size 06</b></p>		
		

## SCE Table of Styles – Up to 7 Ways

**SCE-X-67A06-XXSX-001**

**Front Mount Plug  
PCB Contacts**

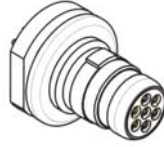

**SCE-X-67A06-XXSX-002**

**Front Mount Plug  
Solder Bucket Contacts**

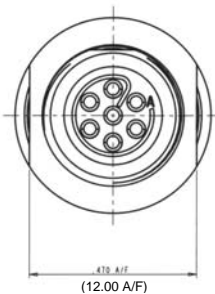

# SCE Table of Styles

## 390-0088-130-XX Plug Dust Cap and Cord Will suit Plugs Shell Size 06

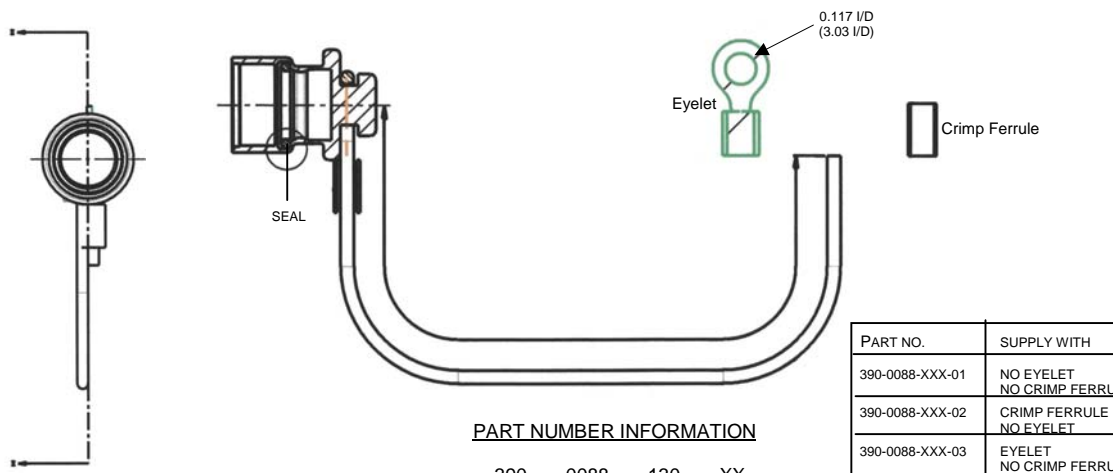

PART NO.	SUPPLY WITH
390-0088-XXX-01	NO EYELET NO CRIMP FERRULE
390-0088-XXX-02	CRIMP FERRULE NO EYELET
390-0088-XXX-03	EYELET NO CRIMP FERRULE

**PART NUMBER INFORMATION**

390 - 0088 - 130 - XX

SERIES ————— 390

STYLE – PROTECTIVE CAP FOR SCE PLUG ————— 0088

CORD LENGTH (in mm) ————— 130

CRIMP/EYELET ————— XX

## 390-5019-XXX-XX(771) Receptacle Dust Cap and Cord Will suit Snatch and Latch Shell Size 07

Cord is Black  
Eyelet and crimp ferrule black zinc cobalt

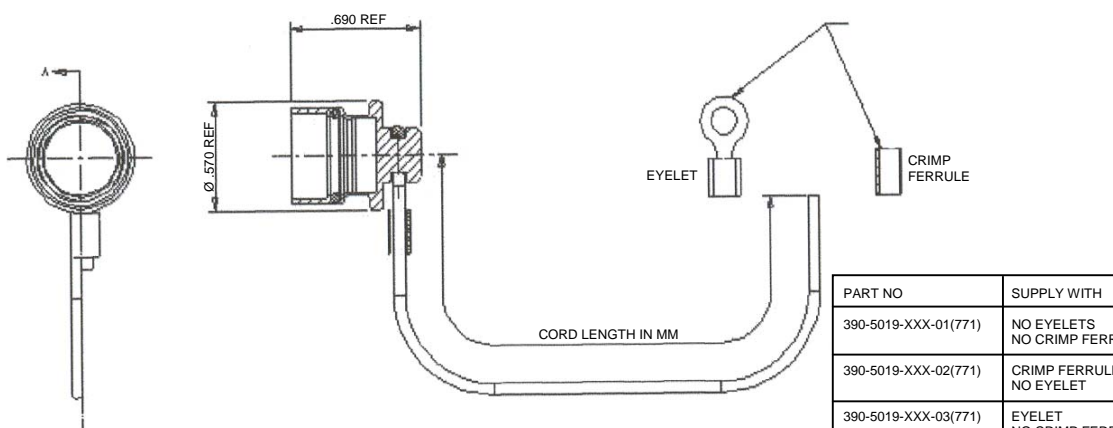

PART NO	SUPPLY WITH
390-5019-XXX-01(771)	NO EYELETS NO CRIMP FERRULE
390-5019-XXX-02(771)	CRIMP FERRULE NO EYELET
390-5019-XXX-03(771)	EYELET NO CRIMP FERRULE

**PART NO SUPPLY WITH**

CORD LENGTH IN MM



# Heatshrink Boots

## 100 Series – Bottle Shapes with Rib – MIL Style

### For use with SCE-06T and SCE-01T

We have selected Heatshrink Boots from Hellermann Tyton. Heatshrink Boots from other manufacturers may be used if appropriate.

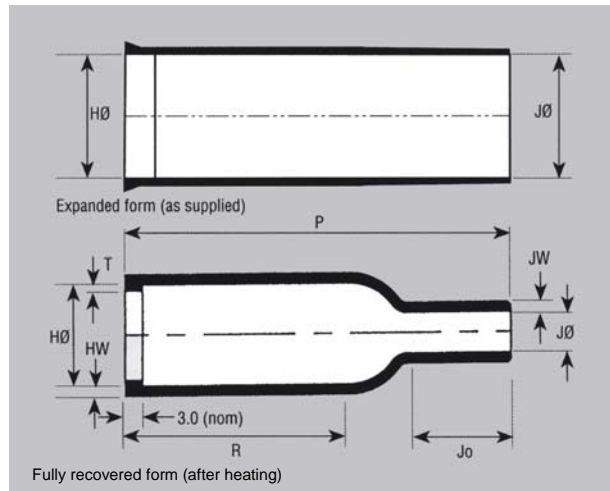

This style is used in conjunction with the backshell (see page 13) providing strain relief and environmental sealing

Dimensions apply to all materials unless otherwise indicated

Hellermann Part No	Expanded (Min)				Recovered (Max)		Recovered Dimensions Fully Shrunk					
	H	H -H matl	JØ	J -H matl	H	JØ	P ±10%	R ±10%	Jo ±10%	HW ±10%	JW ±10%	T ±10%
113-4-G-WM250	0.3976 (10.7)	0.3976 (10.7)	0.1811 (4.6)	0.1811 (4.6)	0.3110 (7.9)	0.0787 (2.0)	1.0 (25.4)	0.5709 (14.5)	0.1811 (4.6)	0.0512 (1.3)	0.0512 (1.3)	0.0394 (1.0)
104-4-G-WM250	0.6456 (16.4)	0.6456 (16.4)	0.6456 (16.4)	0.6456 (16.4)	0.3110 (7.9)	0.149 (3.8)	1.0 (25.4)	0.5590 (14.2)	0.2716 (6.9)	0.0512 (1.3)	0.0512 (1.3)	0.0394 (1.0)

## 1100 Series – Right Angle Shapes with Rib – MIL Style

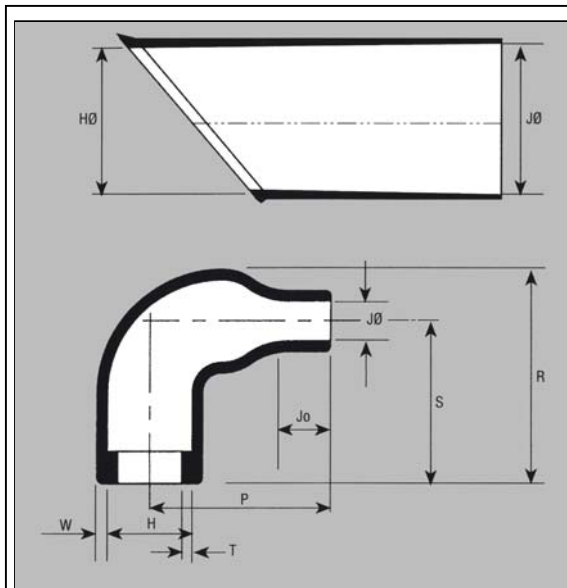

The style provides strain relief for harness systems when used in conjunction with the backshell (see page 13)

Dimensions apply to all materials unless otherwise indicated

Hellermann Part No	Expanded (Min)		Recovered (Max)		Recovered Dimensions Fully Shrunk					
	H	JØ	H	JØ	P ±10%	R ±10%	S ±10%	Jo ±10%	W ±20%	T ±20%
1108-4-G-WM250	0.6496 (16.5)	0.6496 (16.5)	0.3110 (7.9)	0.1496 (3.8)	0.6875 (17.3)	0.7969 (20.1)	0.6005 (15.2)	0.1614 (4.1)	0.0394 (1.0)	0.0394 (1.0)
1106-4-G-WM250	0.9173 (23.3)	0.9173 (23.3)	0.4094 (10.04)	0.2204 (5.6)	0.7992 (20.3)	0.9015 (22.9)	0.6005 (15.2)	0.2283 (5.8)	0.0511 (1.3)	0.0394 (1.0)

# SCE Plug to Header Cable Assemblies

## 20GB-SCE-6XXX-XXX Jam Nut Plug Rear Mount to Header Assembly – Solder Bucket Contacts only



VARIANT	LENGTH
025	25MM
050	50MM
075	75MM
100	100MM
125	125MM
150	150MM



Panel Nut - Torque to 2.25Nm = 1.65 foot lbs force

Please contact Amphenol for full part numbering information

## 20GB- SCE-6XXX-XXX Jam Nut Plug Front Mount to Header Assembly – Solder Bucket Contacts only



VARIANT	LENGTH
025	25MM
050	50MM
075	75MM
100	100MM
125	125MM
150	150MM



Panel Nut - Torque to 2.25Nm = 1.65 foot lbs force

Please contact Amphenol for full part numbering information

# SCE - Cable Assemblies

**Amphenol can supply complete overmoulded cable harness solutions to your specifications. Please consult factory for cable number allocation.**

## Up to 7 Way Single-Ended Receptacle Cable Assembly



**NOTES:**

1. THE MAIN KEY OF THE CONNECTOR IS TO BE IN LINE WITH THE LOCATION RIB ON THE OVERMOULD
2. ALL DIMENSIONS ARE FOR REFERENCE ONLY
3. XXX.X IN PART NUMBER DENOTES CABLE LENGTH IN METRES E.G. 5.5M = 005.5

**PART NUMBER INFORMATION**



All Dimensions are for reference only  
(Dimensions in brackets are in mm)

## Up to 7 Way Double-Ended Receptacle to Receptacle Cable Assembly

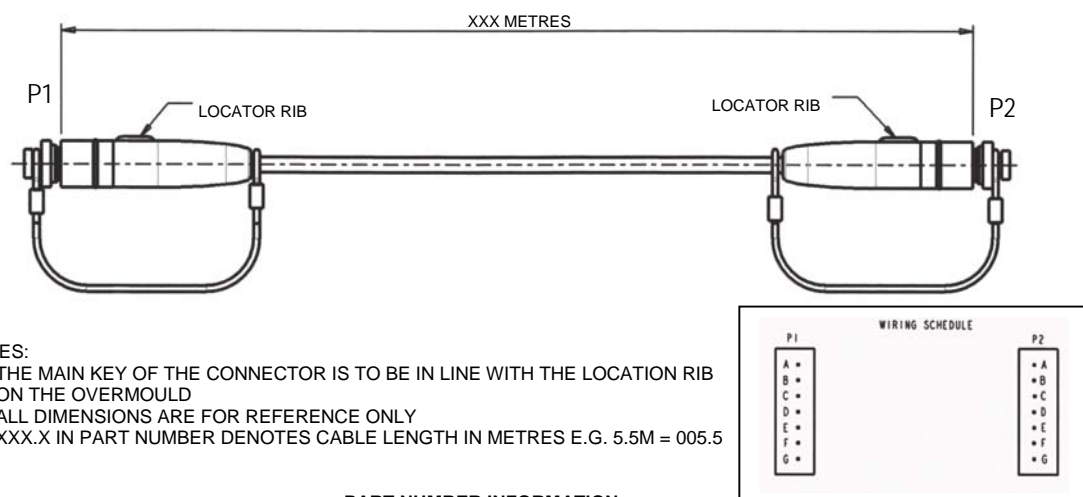

**NOTES:**

1. THE MAIN KEY OF THE CONNECTOR IS TO BE IN LINE WITH THE LOCATION RIB ON THE OVERMOULD
2. ALL DIMENSIONS ARE FOR REFERENCE ONLY
3. XXX.X IN PART NUMBER DENOTES CABLE LENGTH IN METRES E.G. 5.5M = 005.5

**PART NUMBER INFORMATION**



# SCE - Cable Assemblies

## Up to 7 Way Single-Ended Receptacle Coiled Cable Assembly



**NOTES:**

1. THE MAIN KEY OF THE CONNECTOR IS TO BE IN LINE WITH THE LOCATION RIB ON THE OVERMOULD
2. ALL DIMENSIONS ARE FOR REFERENCE ONLY
3. XXX.X IN PART NUMBER DENOTES CABLE LENGTH IN METRES E.G. 5.5M = 005.5

**PART NUMBER INFORMATION**



All Dimensions are for reference only  
(Dimensions in brackets are in mm)

## Up to 7 Way Double-Ended Receptacle to Receptacle Coiled Cable Assembly



**NOTES:**

1. THE MAIN KEY OF THE CONNECTOR IS TO BE IN LINE WITH THE LOCATION RIB ON THE OVERMOULD
2. ALL DIMENSIONS ARE FOR REFERENCE ONLY
3. XXX.X IN PART NUMBER DENOTES CABLE LENGTH IN METRES E.G. 5.5M = 005.5

**PART NUMBER INFORMATION**



## SCE Connector Part Numbers – Receptacles only



\* Please consult factory.

Note: If ordering 01K and L1K receptacles, please omit the cable variant from the part number.

## SCE Connector Part Numbers – Plugs only



\* Please consult factory.

Note: For castellated panel nut, please add (981) at the end of plug part number

## SCE Crimp Tool

### For Braid Termination Style 003

Crimp the Braid into place so that the ferrule butts up against the shoulder of the backshell. Use crimp tool Daniels HX4 M22520/5-01 handle, crimp die set Daniels Y530 CAGE 11851 at setting 180.



July 2006

**Notice:** Products are sold subject to Amphenol's Standard Conditions of Sale. All specifications and statements contained herein are believed to be correct at the time of printing but no representation or warranty, express or implied, is given as to any specification or statement contained herein. Product specifications including performance characteristics are typical only and subject to deviation. Specifications are also subject to change without notice. Users should not assume that all safety measures are indicated or that other measures may not be required. No representation or warranty, express or implied, is given that any use of products (including any stated or suggested use) does not infringe any patent, registered design or other third party rights and no stated or suggested use of products can be taken to recommend any such infringement.

**Amphenol PCD**

72 Cherry Hill Rd, Beverly, MA 01915, USA Tel: 978-624-3400

Компания «Life Electronics» занимается поставками электронных компонентов импортного и отечественного производства от производителей и со складов крупных дистрибьюторов Европы, Америки и Азии.

С конца 2013 года компания активно расширяет линейку поставок компонентов по направлению коаксиальный кабель, кварцевые генераторы и конденсаторы (керамические, пленочные, электролитические), за счёт заключения дистрибьюторских договоров

Мы предлагаем:

- Конкурентоспособные цены и скидки постоянным клиентам.
- Специальные условия для постоянных клиентов.
- Подбор аналогов.
- Поставку компонентов в любых объемах, удовлетворяющих вашим потребностям.
- Приемлемые сроки поставки, возможна ускоренная поставка.
- Доставку товара в любую точку России и стран СНГ.
- Комплексную поставку.
- Работу по проектам и поставку образцов.
- Формирование склада под заказчика.
- Сертификаты соответствия на поставляемую продукцию (по желанию клиента).
- Тестирование поставляемой продукции.
- Поставку компонентов, требующих военную и космическую приемку.
- Входной контроль качества.
- Наличие сертификата ISO.

В составе нашей компании организован Конструкторский отдел, призванный помогать разработчикам, и инженерам.

Конструкторский отдел помогает осуществить:

- Регистрацию проекта у производителя компонентов.
- Техническую поддержку проекта.
- Защиту от снятия компонента с производства.
- Оценку стоимости проекта по компонентам.
- Изготовление тестовой платы монтаж и пусконаладочные работы.



Тел: +7 (812) 336 43 04 (многоканальный)  
Email: org@lifeelectronics.ru