



Is Now Part of



**ON Semiconductor®**

To learn more about ON Semiconductor, please visit our website at  
[www.onsemi.com](http://www.onsemi.com)

Please note: As part of the Fairchild Semiconductor integration, some of the Fairchild orderable part numbers will need to change in order to meet ON Semiconductor's system requirements. Since the ON Semiconductor product management systems do not have the ability to manage part nomenclature that utilizes an underscore (\_), the underscore (\_) in the Fairchild part numbers will be changed to a dash (-). This document may contain device numbers with an underscore (\_). Please check the ON Semiconductor website to verify the updated device numbers. The most current and up-to-date ordering information can be found at [www.onsemi.com](http://www.onsemi.com). Please email any questions regarding the system integration to [Fairchild\\_questions@onsemi.com](mailto:Fairchild_questions@onsemi.com).

ON Semiconductor and the ON Semiconductor logo are trademarks of Semiconductor Components Industries, LLC dba ON Semiconductor or its subsidiaries in the United States and/or other countries. ON Semiconductor owns the rights to a number of patents, trademarks, copyrights, trade secrets, and other intellectual property. A listing of ON Semiconductor's product/patent coverage may be accessed at [www.onsemi.com/site/pdf/Patent-Marking.pdf](http://www.onsemi.com/site/pdf/Patent-Marking.pdf). ON Semiconductor reserves the right to make changes without further notice to any products herein. ON Semiconductor makes no warranty, representation or guarantee regarding the suitability of its products for any particular purpose, nor does ON Semiconductor assume any liability arising out of the application or use of any product or circuit, and specifically disclaims any and all liability, including without limitation special, consequential or incidental damages. Buyer is responsible for its products and applications using ON Semiconductor products, including compliance with all laws, regulations and safety requirements or standards, regardless of any support or applications information provided by ON Semiconductor. "Typical" parameters which may be provided in ON Semiconductor data sheets and/or specifications can and do vary in different applications and actual performance may vary over time. All operating parameters, including "Typicals" must be validated for each customer application by customer's technical experts. ON Semiconductor does not convey any license under its patent rights nor the rights of others. ON Semiconductor products are not designed, intended, or authorized for use as a critical component in life support systems or any FDA Class 3 medical devices or medical devices with a same or similar classification in a foreign jurisdiction or any devices intended for implantation in the human body. Should Buyer purchase or use ON Semiconductor products for any such unintended or unauthorized application, Buyer shall indemnify and hold ON Semiconductor and its officers, employees, subsidiaries, affiliates, and distributors harmless against all claims, costs, damages, and expenses, and reasonable attorney fees arising out of, directly or indirectly, any claim of personal injury or death associated with such unintended or unauthorized use, even if such claim alleges that ON Semiconductor was negligent regarding the design or manufacture of the part. ON Semiconductor is an Equal Opportunity/Affirmative Action Employer. This literature is subject to all applicable copyright laws and is not for resale in any manner.

# FAN6248

## Advanced Synchronous Rectifier Controller for LLC Resonant Converter

The FAN6248 is an advanced synchronous rectifier (SR) controller that is optimized for LLC resonant converter topology with minimum external components. It has two driver stages for driving the SR MOSFETs which are rectifying the outputs of the secondary transformer windings. The two gate driver stages have their own sensing inputs and operate independently of each other. The adaptive parasitic inductance compensation function minimizes the body diode conduction maximizing the efficiency. The advanced control algorithm allows stable SR operation over entire load range. FAN6248 has two different versions - FAN6248HAMX having higher turn-off threshold voltage and FAN6248HBMX having lower turn-off threshold voltage.

### Features

- Highly integrated self-contained control of synchronous rectifier with a minimum external component count
- Optimized for LLC resonant converter
- Anti shoot-through control for reliable SR operation
- Separate 100V rated sense inputs for sensing the drain and source voltage of each SR MOSFET
- Adaptive parasitic inductance compensation to minimize the body diode conduction
- SR current inversion detection under light load condition
- Light load detection
- Adaptive minimum on time for noise immunity
- Operating voltage range up to 30 V
- Low start-up and stand-by current consumption
- Operating frequency range from 25kHz up to 700 kHz
- SOIC-8 Package
- High driver output voltage of 10.5 V to drive all MOSFET brands to the lowest  $R_{DS\_ON}$
- Low operating current in green mode (typ. 350uA)

### Applications

- High power density laptop adapter
- High Power Density Adapter
- Large Screen LCD-TV, PDP-TV, RP-TV Power
- High-Efficiency Desktop and Server Power Supplies
- Networking and Telecom Power Supplies
- High Power LED Lighting



**ON Semiconductor®**

[www.onsemi.com](http://www.onsemi.com)

### PACKAGE PICTURE

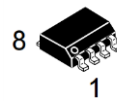

SOIC-8 NB  
CASE 751

### MARKING DIAGRAM

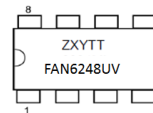

U = Frequency, H:High  
V = Vth\_off level, A or B  
Z = Assembly Plant Code  
X = Year Code  
Y = Two Week Code  
TT = Die Run Code

### PIN CONNECTIONS

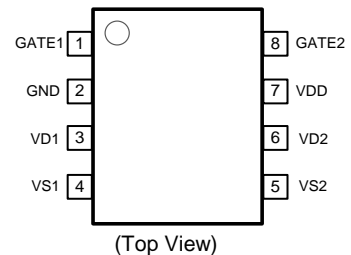

### ORDERING INFORMATION

See detailed ordering and shipping information on page 3 of this data sheet.

# FAN6248

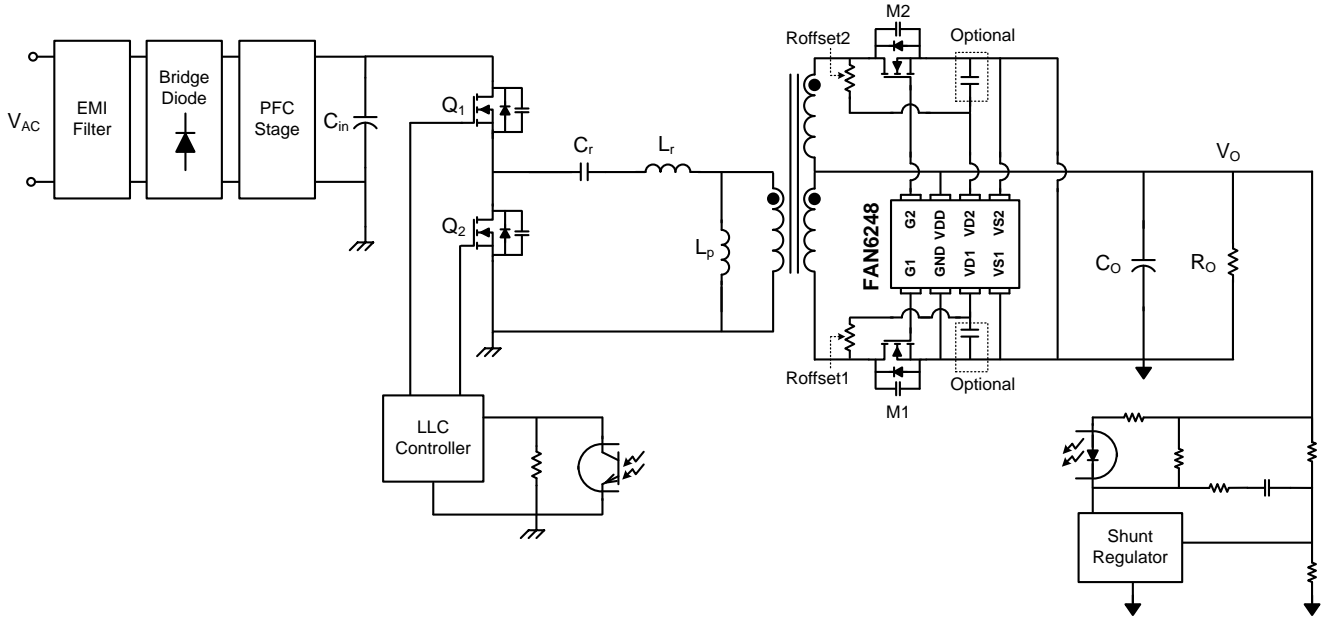

Figure 1. Typical Application Schematic of FAN6248

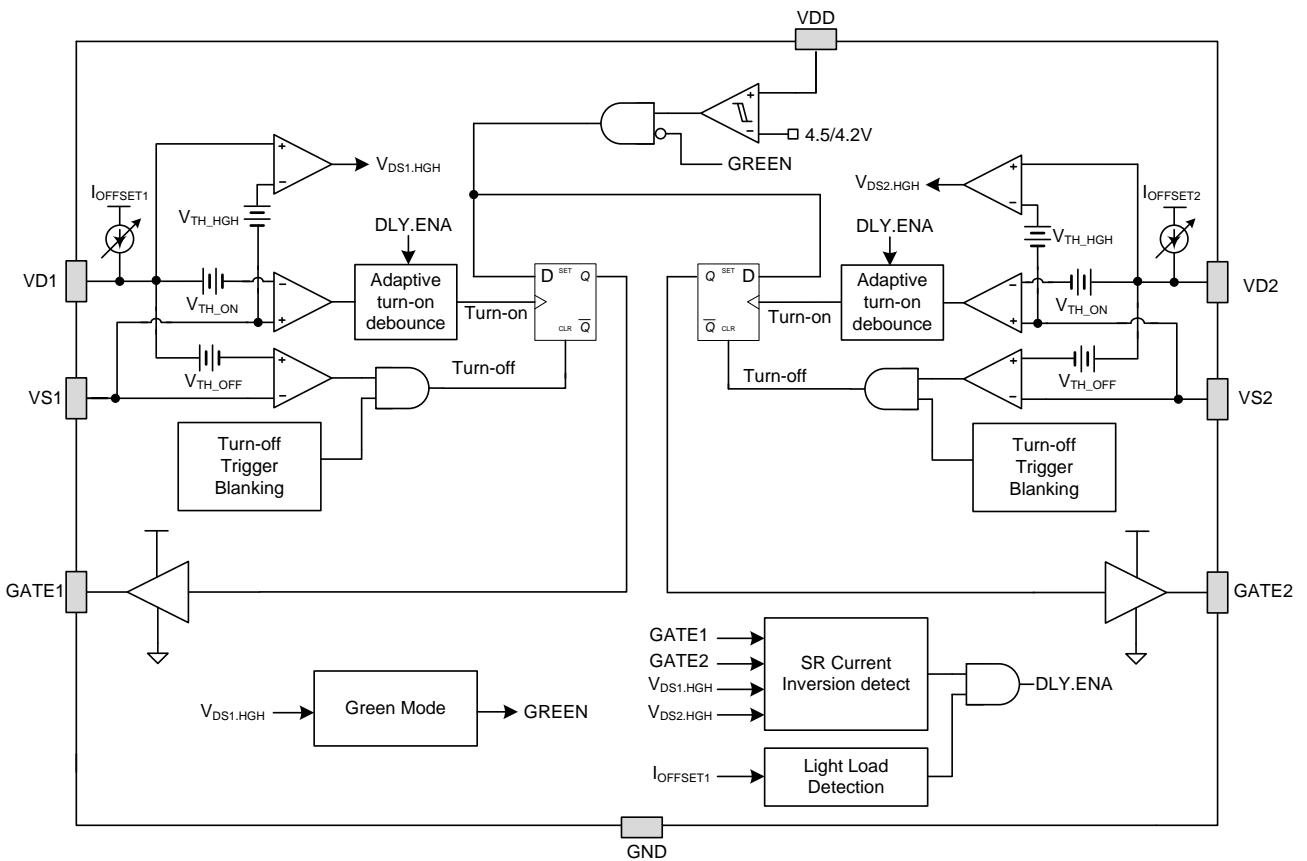

Figure 2. Internal Block Diagram of FAN6248

## FAN6248

### Pin Description

Pin Number	Name	Description
1	GATE1	Gate drive output for SR1
2	GND	Ground
3	VD1	Synchronous rectifier drain sense input. A $I_{\text{OFFSET1}}$ current source flows out of the DRAIN pin such that an external series resistor can be used to adjust the synchronous rectifier turn-off threshold. The $I_{\text{OFFSET1}}$ current source is turned off when $V_{\text{DD}}$ is under-voltage or when switching is disabled in green mode
4	VS1	Synchronous rectifier source sense input for SR1
5	VS2	Synchronous rectifier source sense input for SR2
6	VD2	Synchronous rectifier drain sense input. A $I_{\text{OFFSET2}}$ current source flows out of the DRAIN pin such that an external series resistor can be used to adjust the synchronous rectifier turn-off threshold. The $I_{\text{OFFSET2}}$ current source is turned off when $V_{\text{DD}}$ is under-voltage or when switching is disabled in green mode
7	VDD	Supply Voltage
8	GATE2	Gate drive output for SR2

### Ordering and Shipping Information

Ordering Code	Device Marking	$V_{\text{TH\_OFF1}} / V_{\text{TH\_OFF2}}$	Package	Shipping
FAN6248HAMX	FAN6248HA	130mV / 228mV	SOIC-8	2500 / Tape & Reel
FAN6248HBMX	FAN6248HB	100mV / 175mV	SOIC-8	2500 / Tape & Reel

# FAN6248

## MAXIMUM RATINGS

Stresses exceeding the absolute maximum ratings may damage the device. If any of these limits are exceeded, device functionality should not be assumed. In addition, extended exposure to stresses above the recommended operating conditions may affect device reliability.

Symbol	Parameter	Min.	Max.	Unit
V <sub>DD</sub>	Power Supply Input Pin Voltage	-0.3	30	V
V <sub>D1</sub> , V <sub>D2</sub>	Drain Sense Input Pin Voltage	-1	100	V
V <sub>GATE1</sub> , V <sub>GATE2</sub>	Gate Drive Output Pin Voltage	-0.3	30	V
V <sub>S1</sub> , V <sub>S2</sub>	Source Sense Input Pin Voltage	-0.4	0.4	V
P <sub>D</sub>	Power Dissipation (T <sub>A</sub> =25°C)		0.625	W
Θ <sub>JA</sub>	Thermal Resistance (Junction-to-Ambient Thermal)		165	°C/W
T <sub>J</sub>	Operating Junction Temperature	-40	150	°C
T <sub>STG</sub>	Storage Temperature Range	-60	150	°C
T <sub>L</sub>	Lead Temperature (Soldering) 10 Seconds		260	°C
ESD	Electrostatic Discharge Capability	Human Body Model, ANSI / ESDA / JEDEC JS-001-2012		kV
		Charged Device Model, JESD22-C101		
			4	
			1.75	

### Notes:

1. All voltage values are with respect to the GND pin.

## THERMAL CHARACTERISTICS

Rating	Symbol	Value	Unit
Thermal Characteristics	R <sub>ψJT</sub>	22	°C/W
Thermal Characteristics	R <sub>θJA</sub>	165	°C/W

## Recommended Operating Conditions

The Recommended Operating Conditions table defines the continuous conditions for actual device operation. Recommended operating conditions are specified to ensure optimal performance to the data sheet specifications. ON Semiconductor does not recommend exceeding them or designing to Absolute Maximum Ratings

Symbol	Parameter	Min.	Max.	Unit
V <sub>DD</sub> <sup>2</sup>	VDD Pin Supply Voltage to GND	0	27	V
V <sub>D1</sub> , V <sub>D2</sub>	Drain Sense Input Pin Voltage	-0.7	100	V
V <sub>S1</sub> V <sub>S2</sub>	Source Sense Input Pin Voltage	-0.4	0.4	V
T <sub>A</sub> <sup>3</sup>	Operating Ambient Temperature	-40	+125	°C

### Notes:

2. Allowable operating supply voltage V<sub>DD</sub> can be limited by the power dissipation of FAN6248 related to switching frequency, load capacitance and ambient temperature.
3. Allowable operating ambient temperature can be limited by the power dissipation of FAN6248 related to switching frequency, load capacitance on GATE pin and V<sub>DD</sub>.

# FAN6248

## Electrical Characteristics

$V_{DD} = 12V$  and  $T_J = -40^{\circ}C$  to  $125^{\circ}C$  unless otherwise specified

Symbol	Parameter	Conditions	Min	Typ	Max	Unit
<b>Input Voltage</b>						
$V_{DD\_ON}$	Turn-On Threshold	$V_{DD}$ rising	4.3	4.5	4.7	V
$V_{DD\_OFF}$	Turn-Off Threshold	$V_{DD}$ falling	4.0	4.2	4.4	V
$I_{DD\_OP}$	Operating Current	$f_{SW} = 100kHz$ , $C_{GATE} = 3.3nF$	7	8.5	10	mA
$I_{DD\_SRSTARTUP}$		$V_{DD} = V_{DD\_ON} - 0.1V$			200	$\mu A$
$I_{DD\_GREEN}$	Operating Current in Green Mode	$V_{DD} = 12V$ (no switching)		350	500	$\mu A$
<b>Drain Voltage Sensing Section</b>						
$V_{OSI}^{(1)}$	Comparator Input Offset Voltage		-1	0	1	mV
$I_{OFFSET}$	$I_{OFFSET1}$ and $I_{OFFSET2}$	Maximum of adaptive offset current (15 steps, 9uA resolution) $I_{OFFSET} = I_{OFFSET\_STEP15}$	112.5	135	157.5	$\mu A$
$V_{TH\_ON}$	Turn-On Threshold	$R_{DRAIN} = 0\Omega$ (includes comparator input offset voltage)	-290	-240	-190	mV
$t_{ON\_DLY}^{(1)}$	Turn on delay for de-bounce time when turn-on delay mode is disabled by detecting normal SR current	From $V_{DS}$ falling below $V_{TH\_ON}$ to $V_{GATE}$ rising above $V_{G\_HG}$ (With 50mV overdrive), $C_{GATE} = 0nF$		80		ns
$t_{ON\_DLY2\_H}^{(1)}$	Turn on delay for de-bounce time when turn-on delay mode is enabled by detecting SR current inversion for HA and HB version	From $V_{DS}$ falling below $V_{TH\_ON}$ to $V_{GATE}$ rising above $V_{G\_HG}$ (With 50mV overdrive), $C_{GATE} = 0nF$		380		ns
$V_{TH\_OFF1\_A}^{(1)}$	First level Turn-Off Threshold for LA and HA version	$R_{DRAIN} = 0\Omega$ (includes comparator input offset voltage)		130		mV
$V_{TH\_OFF2\_HA}^{(1)}$	Second level Turn-Off Threshold for HA version	$R_{DRAIN} = 0\Omega$ (includes comparator input offset voltage)		228		mV
$V_{TH\_OFF1\_B}^{(1)}$	First level Turn-Off Threshold for LB and HB version	$R_{DRAIN} = 0\Omega$ (includes comparator input offset voltage)		100		mV
$V_{TH\_OFF2\_HB}^{(1)}$	Second level Turn-Off Threshold for HB version	$R_{DRAIN} = 0\Omega$ (includes comparator input offset voltage)		175		mV
$t_{OFF\_DLY}^{(1)}$	Comparator delay for $V_{TH\_OFF1}$	From $V_{DS}$ rising above $V_{TH\_OFF}$ to $V_{GATE}$ falling below $V_{G\_LW}$ (With 10mV overdrive), $C_{GATE} = 0nF$		80		ns
$V_{TH\_HGH}$	Drain voltage high detect threshold	$V_{DS}$ Rising	0.65	0.8	0.95	V
$t_{DB\_HGH\_H}^{(1)}$	$V_{TH\_HGH}$ detection blanking time for HA and HB version	From $V_{DS}$ falling below $V_{TH\_ON}$		400		ns
<b>Minimum On-Time and Maximum On-Time</b>						
$K_{TON}^{(1)}$	Adaptive minimum on time ratio	Ratio between $t_{ON\_MIN}$ and SR conduction time of previous switching cycle		50		%
$t_{ON\_MIN\_LH}^{(1)}$	Minimum On-Time Lower Limit for HA and HB version			200		ns
$t_{ON\_MIN\_UH}$	Minimum On-Time Upper Limit for HA and HB version		0.96	1.2	1.44	$\mu s$
$t_{SR\_CNDT\_H}$	Minimum SR conduction time to enable SR for HA and HB version	The duration from turn-on trigger to $V_{DS}$ rising above $V_{TH\_HGH}$	380	600	820	ns

## FAN6248

Symbol	Parameter	Conditions	Min	Typ	Max	Unit
t <sub>SR_MAX_H</sub> <sup>(1)</sup>	Maximum SR turn-on time for HA and HB version			15		μs
<b>Regulated Dead Time</b>						
t <sub>DEAD_H</sub> <sup>(1)</sup>	Dead time regulation target for HA and HB version	From V <sub>GATE</sub> falling below V <sub>G_LW</sub> to V <sub>DS</sub> rising above V <sub>TH_HGH</sub>		200		ns
t <sub>DEAD_H_LIGHT</sub> <sup>(1)</sup>	Dead time regulation target under light load condition for HA and HB version	From V <sub>GATE</sub> falling below V <sub>G_LW</sub> to V <sub>DS</sub> rising above V <sub>TH_HGH</sub>		250		ns
t <sub>TSDT</sub> <sup>(1)</sup>	Too small dead time threshold to speed up I <sub>OFFSET</sub> change (Speed up 2 times)	From V <sub>GATE</sub> falling below V <sub>G_LW</sub> to V <sub>DS</sub> rising above V <sub>TH_HGH</sub>		35		ns
K <sub>INV</sub> <sup>(1)</sup>	Adaptive SR current inversion detection time Ratio between T <sub>INV</sub> and SR conduction time of previous switching cycle	V <sub>GATE</sub> > V <sub>G_HG</sub> and V <sub>DS</sub> > V <sub>TH_OFF</sub>		12.5		%
<b>Green Mode Control</b>						
t <sub>GRN_ENT_H</sub>	Non-Switching Period to Enter Green Mode for HA and HB version	Non switching cycles between burst switching bundles	60	80	100	μs
t <sub>GRN_ENT_DBNC_H</sub>	De-bounce time to Enter Green Mode for HA and HB version	De-bounce time after t <sub>GRN_ENT_H</sub>	130	180	230	μs
t <sub>GRN_EXT_H</sub>	Non-Switching Period to Exit Green for HA and HB version	Non switching cycles between burst switching bundles	30	40	50	μs
η <sub>CSW_EXT</sub>	Continuous switching cycles to exit Green Mode		7	11	15	cycle
t <sub>S_NORMAL_H</sub>	Switching period to be recognized as normal switching for HA and HB version		13	20	27	μs
<b>Output Driver Section</b>						
V <sub>GATE_MAX</sub>	Gate clamping voltage	12V < V <sub>DD</sub> < 25 V	9	10.5	12	V
V <sub>GATE_MAX_5V</sub>	Gate clamping voltage	V <sub>DD</sub> =5V	4.9			
V <sub>OL</sub>	Output Voltage Low	V <sub>DD</sub> =12V, V <sub>D1</sub> =V <sub>D2</sub> =2V, I <sub>GATE</sub> =50mA			1.5	V
V <sub>OH</sub>	Output Voltage High	V <sub>DD</sub> =12V, I <sub>GATE</sub> =-50mA	7			V
I <sub>SOURCE</sub> <sup>(1)</sup>	Peak source current for turning on	V <sub>DD</sub> =12V, V <sub>GATE</sub> =2V		0.7		A
I <sub>SINK</sub> <sup>(1)</sup>	Peak sink current for turning off	V <sub>DD</sub> =12V, V <sub>GATE</sub> =7V		1.4		A
t <sub>R</sub> <sup>(1)</sup>	Rise Time	V <sub>DD</sub> =12V, C <sub>L</sub> =3.3nF, V <sub>GATE</sub> =2V→7V		50		ns
t <sub>F</sub> <sup>(1)</sup>	Fall Time	V <sub>DD</sub> =12V, C <sub>L</sub> =3.3nF, V <sub>GATE</sub> =7V→2V		30		ns
V <sub>G_LW</sub> <sup>(1)</sup>	Gate voltage considered as turned off for adaptive dead time control	Gate falling		2		V
V <sub>G_HG</sub> <sup>(1)</sup>	Gate voltage considered as turned on for adaptive dead time control	Gate rising		2.8		V
<b>Switching frequency</b>						
f <sub>MAX</sub> <sup>(1)</sup>	Maximum switching frequency		700			kHz
f <sub>MIN</sub> <sup>(1)</sup>	Minimum switching frequency				25	kHz

**Notes:**

(1): Not tested but guaranteed by design

## FAN6248

### KEY DIFFERENT PARAMETERS FOR OPTIONS

Item	FAN6248HA	FAN6248HB
$V_{TH\_OFF1}$	130 mV	100 mV
$V_{TH\_OFF2}$	228 mV	175 mV
$t_{ON\_DLY2}$	380 ns	380 ns
$t_{DB\_HGH}$	400 ns	400 ns
$t_{ON\_MIN\_L}$	200 ns	200 ns
$t_{ON\_MIN\_U}$	1.2 $\mu$ s	1.2 $\mu$ s
$t_{SR\_CNDT}$	0.6 $\mu$ s	0.6 $\mu$ s
$t_{SR\_MAX}$	15 $\mu$ s	15 $\mu$ s
$t_{DEAD}$	200 ns	200 ns
$t_{DEAD\_LIGHT}$	250 ns	250 ns
$t_{GRN\_ENT}$	80 $\mu$ s	80 $\mu$ s
$t_{S\_NORMAL}$	20 $\mu$ s	20 $\mu$ s



TYPICAL CHARACTERISTICS

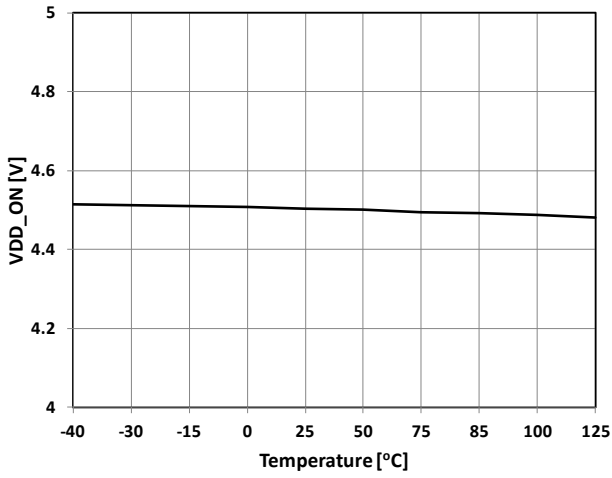

Figure 3. V<sub>DD\_ON</sub>

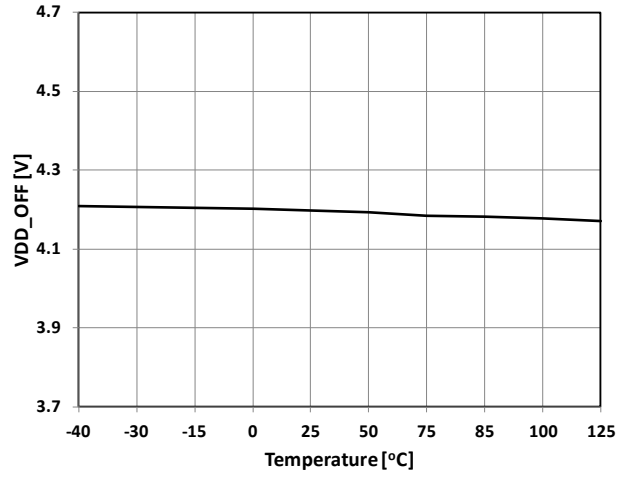

Figure 4. V<sub>DD\_OFF</sub>

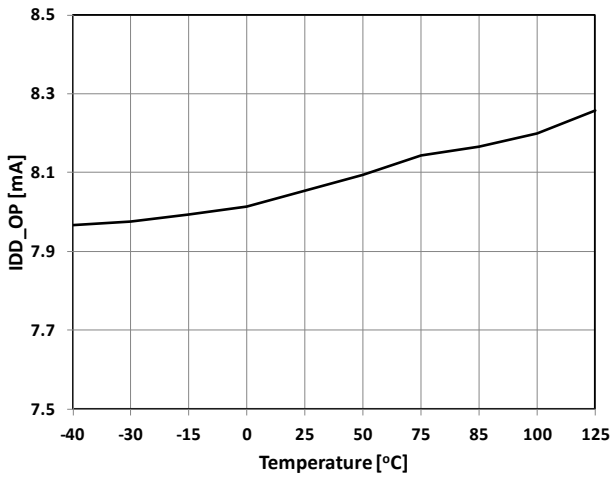

Figure 5. I<sub>DD\_OP</sub>

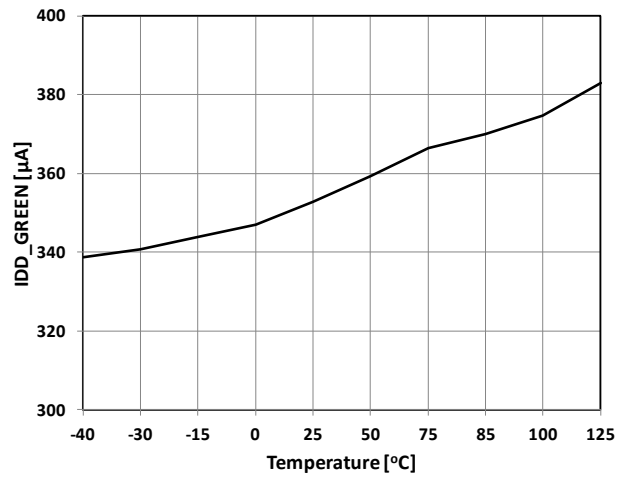

Figure 6. I<sub>DD\_GREEN</sub>

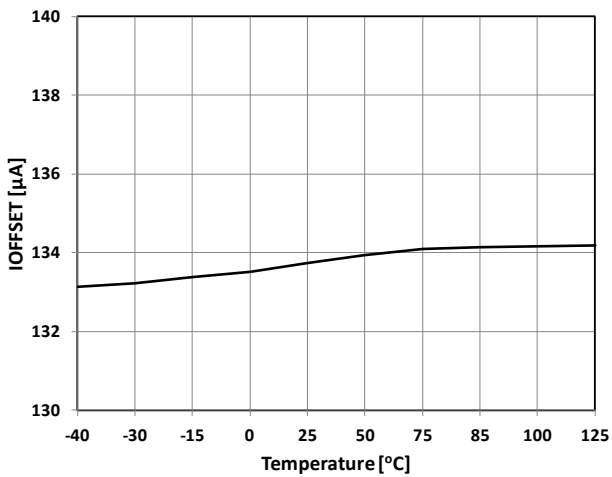

Figure 7. I<sub>OFFSET</sub>

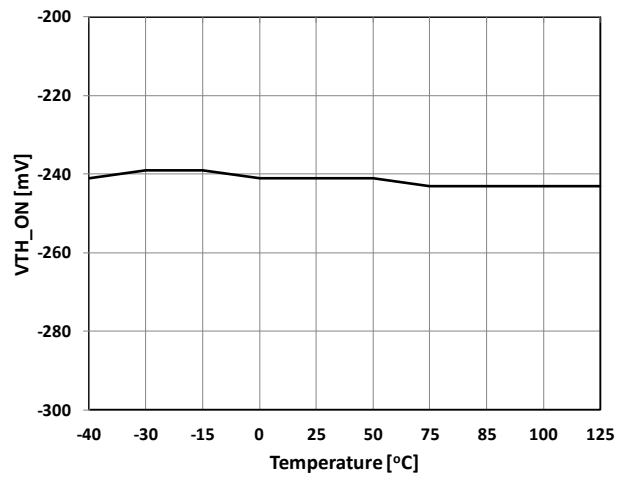

Figure 8. V<sub>TH\_ON</sub>

TYPICAL CHARACTERISTICS

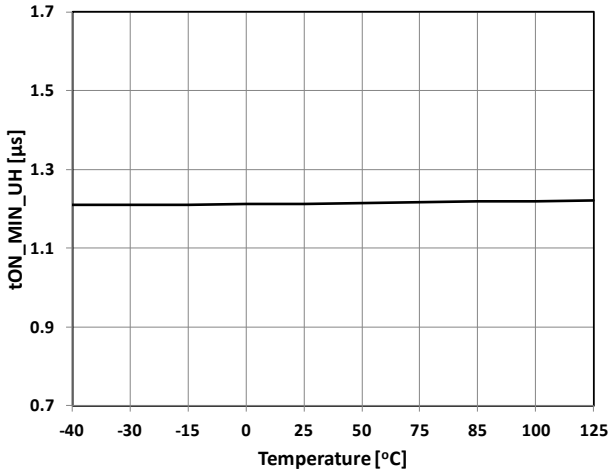

Figure 9. tON\_MIN\_UH

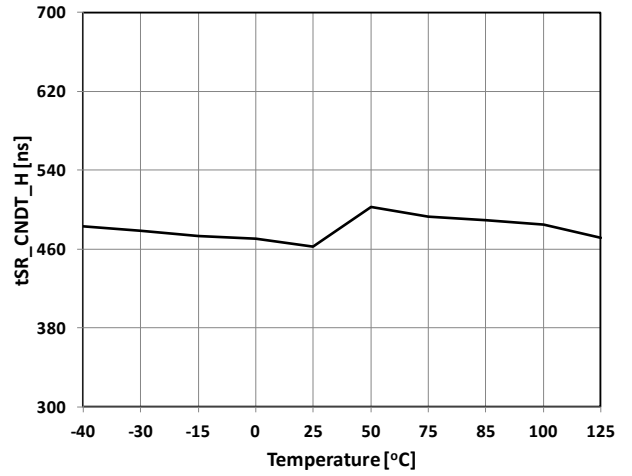

Figure 10. tSR\_CNDT\_H

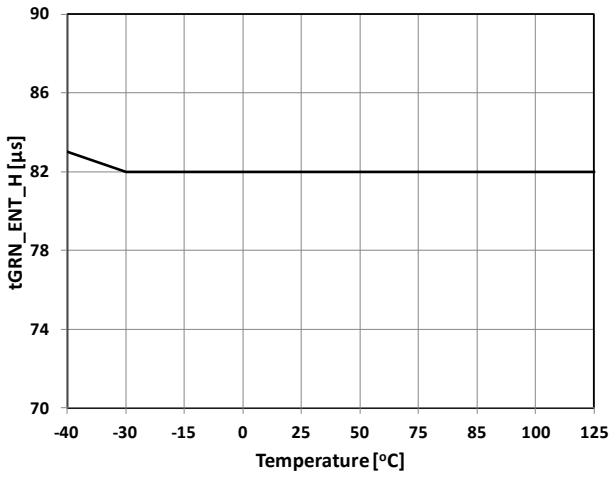

Figure 11. tGRN\_EXT\_H

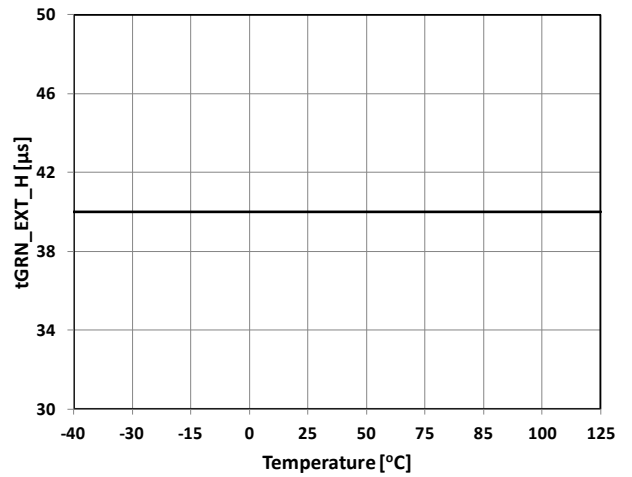

Figure 12. tGRN\_EXT\_H

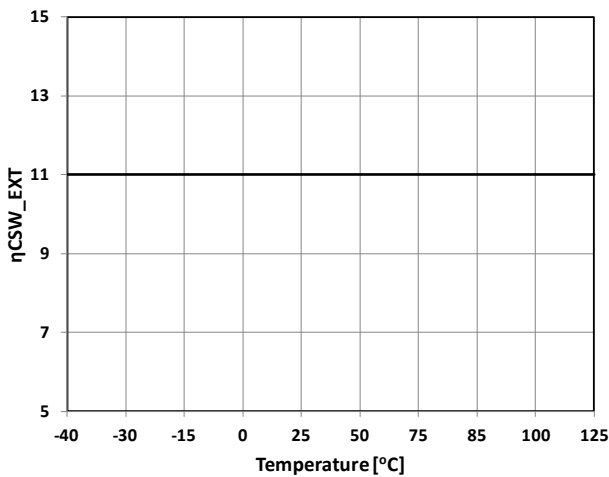

Figure 13. ηCSW\_EXT

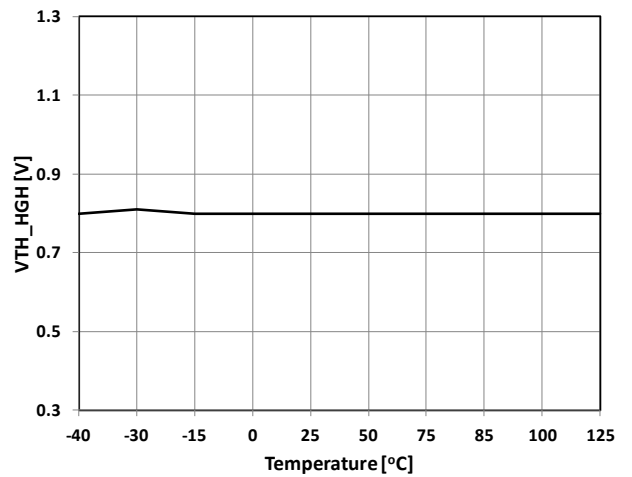

Figure 14. VTH\_HGH

TYPICAL CHARACTERISTICS

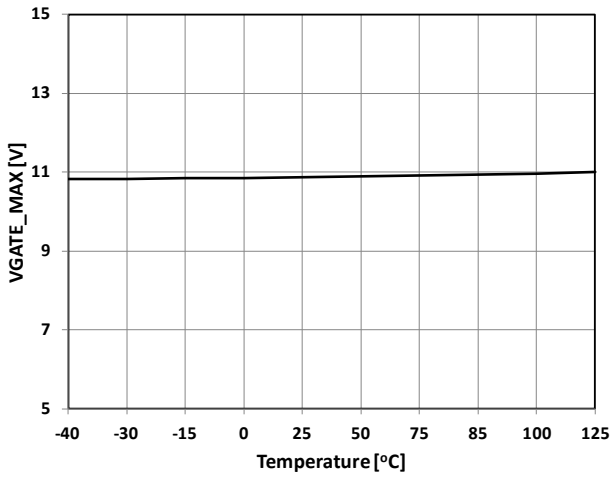

Figure 15. VGATE\_MAX

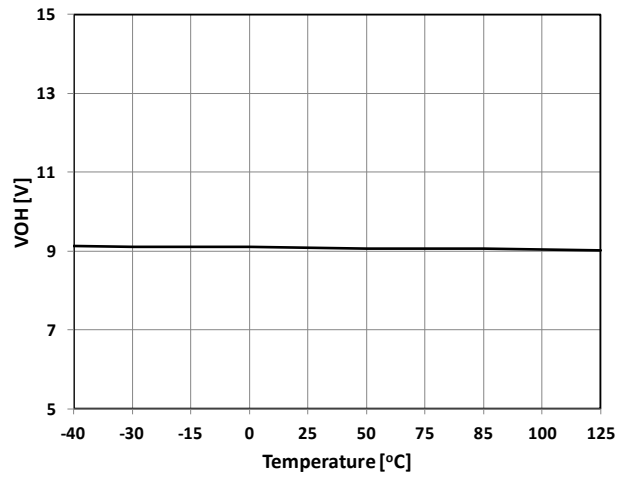

Figure 16. VOH

## Application Information

### Basic Operation Principle

FAN6248 controls the SR MOSFET based on the instantaneous drain-to-source voltage sensed across DRAIN and SOURCE pins. Before SR gate is turned on, SR body diode operates as the conventional diode rectifier. Once the body diode starts conducting, the drain-to-source voltage drops below the turn-on threshold voltage  $V_{TH\_ON}$  which triggers the turn-on of the SR gate. Then the drain-to-source voltage is determined by the product of turn-on resistance  $R_{ds\_on}$  of SR MOSFET and instantaneous SR current. When the drain-to-source voltage reaches the turn-off threshold voltage  $V_{TH\_OFF}$  as SR MOSFET current decreases to near zero, FAN6248 turns off the gate. If a SR dead time is larger or smaller than the dead time regulation target  $t_{DEAD}$ , FAN6248 adaptively changes internal offset voltage to compensate the dead time. In addition, to prevent cross conduction SR operation, FAN6248 has 200ns of turn-on blaking time just after alternating SR gate is turned off.

### SR Turn-off Algorithm

Since a SR turn-off method determines SR conduction time and stable SR operation, the SR turn-off method is one of important feature of SR controllers. The SR turn-off method can be classified into two methods. The first method uses present information by an instantaneous drain voltage. This method is widely used and easy to realize, and can prevent late turn-off. However, it may show premature turn-off by paracitic stray inductances caused by PCB pattern and lead frame of SR MOSFET. The second method predicts SR conduction time by using previous cycle drain voltage information. Since it can prevent the premature turn-off, it is good for the system with constant operating frequency and turn-on time. However, in case of the frequency varying system, it may lead late turn-off so that negative current can flow in the secondary side.

To achieve both advantages, FAN6248 adopts mixed type control method as shown in Figure 17. Basically the instantaneous drain voltage  $V_{Drain}$  is compared with  $V_{TH\_OFF}$  to turn off SR gate. Then, the offset voltage  $V_{offset}$ , which is determined by the product  $R_{offset}$  and  $I_{offset}$ , is added to  $V_{Drain}$  in order to compensate the stray inductance effect and maintain 200ns of  $t_{DEAD}$  regardless of parasitic inductances.  $R_{offset}$  is a external resistor in

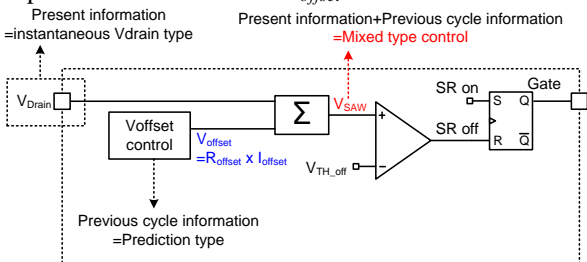

Figure 17. SR turn-off algorithm

Figure 1 and  $I_{offset}$  is an internal modulation current in Figure 2. Therefore, FAN6248 can show robust operation with minimum dead time.

### Adaptive Dead Time Control

The stray inductances of the lead frame of SR MOSFET and PCB pattern induce positive voltage offset across drain-to-source voltage when SR current decreases. This makes drain-to-source voltage of SR MOSFET larger than the product of  $R_{ds\_on}$  and instantaneous SR current, which results in premature turn-off of SR gate. Since the the induced offset voltage changes as load condition changes, the dead time also changes with load variation. To compensate the induced offset voltage, FAN6248 has a adaptive virtual turn-off threshold voltage as shown in Figure 18 with a combination of variable internal turn-off threshold voltages  $V_{TH\_OFF1}$  and  $V_{TH\_OFF2}$  (2 steps) and modulated offset voltage  $V_{offset}$  (16 steps). The virtual turn-off threshold voltage can be expressed as:

$$\text{Virtual } V_{TH\_OFF} = V_{TH\_OFF} - V_{offset} \quad (1)$$

In FAN6248HA(B) version, if a dead time  $T_{DEAD}$  is larger than 200ns of  $t_{DEAD\_H}$ , as shown in Figure 19,  $V_{offset}$  decreases by one step in next switching cycle. As a result, the dead time is decreased by increase of virtual  $V_{TH\_OFF}$ , and becomes close to  $t_{DEAD\_H}$ , as shown in Figure 20. If the dead time is smaller than  $t_{DEAD\_H}$ , the dead time is increased by the virtual  $V_{TH\_OFF}$  decrease. Thus, the dead time is maintained at around  $t_{DEAD\_H}$  regardless of parasitic inductances.

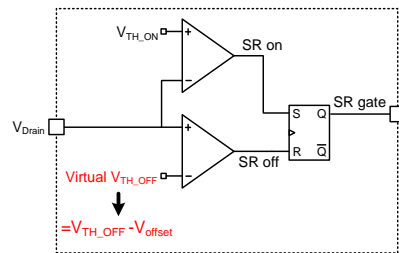

Figure 18. Virtual  $V_{TH\_OFF}$

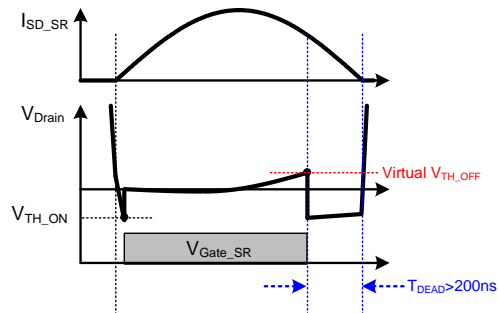

Figure 19. Premature SR gate turn-off ( $T_{DEAD} > t_{DEAD\_H}$ )

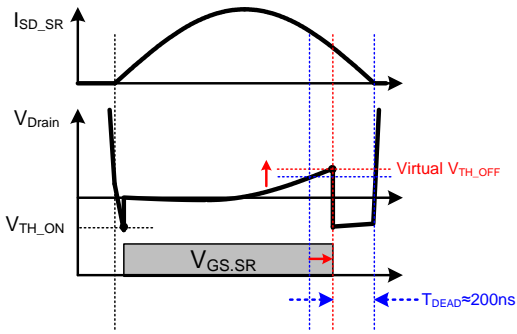

Figure 20. Dead time control to maintain  $T_{DEAD} \approx 200ns$

**Minimum Turn-on Time**

When SR gate is turned on, there may exist severe oscillation in drain-to-source voltage of SR MOSFET, which results in several mis-triggering turn-off as shown in Figure 21. To provide stable SR control without mis-trigger, it is desirable to have large turn-off blanking time (=minimum turn-on time) until the drain voltage oscillation attenuates. However, too large blanking time results in problems at light load condition where the SR conduction time is shorter than the minimum turn-on time. To solve this issue, FAN6248 has adaptive minimum turn-on time where the turn-off blanking time changes in accordance with the SR conduction time  $T_{SRCOND}$  measured in previous switching cycle. The SR conduction time is measured by the time from SR gate rising edge to the instant when drain sensing voltage  $V_{DS\_SR}$  is higher than  $V_{TH\_HGH}$ . From the previous cycle  $T_{SRCOND}$  measurement result, the minimum turn-on time is defined by 50% of  $T_{SRCOND}$ .

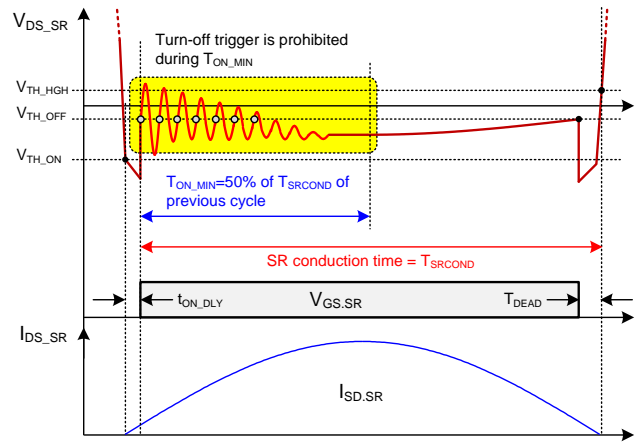

Figure 21. Minimum turn-on time

**Capacitive Current Spike Detection**

At heavy load condition, the body diode of SR MOSFET in LLC resonant converter starts conducting right after the primary side switching transition takes place. However, when the resonance capacitor voltage amplitude is not large enough at light load condition, the voltage across the magnetizing inductance of the transformer is smaller than the reflected output voltage. Thus, the secondary side SR body diode conduction is delayed until the magnetizing inductor voltage builds up to the reflected output voltage. However, the primary side switching transition can cause capacitive current spike and turn on the body diode of SR MOSFET for a short time as shown in Figure 22, which induces SR mis-trigger signal. Finally, the SR mis-trigger makes inversion current in the secondary side. If a proper algorithm is not to prevent the mis-trigger by the capacitive current spike, severe SR current inversion can happen.

To prevent the SR mis-trigger, FAN6248 has a capacitive current spike detection method. When SR current inversion occurs by the mis-trigger signal, the drain sensing voltage of SR MOSFET becomes positive. In this condition, if  $V_{DS\_SR}$  is higher than  $V_{TH\_OFF}$  for  $(T_{SRCOND} * K_{INV})$ , SR current inversion is detected. Then, FAN6248 increases turn-on delay from

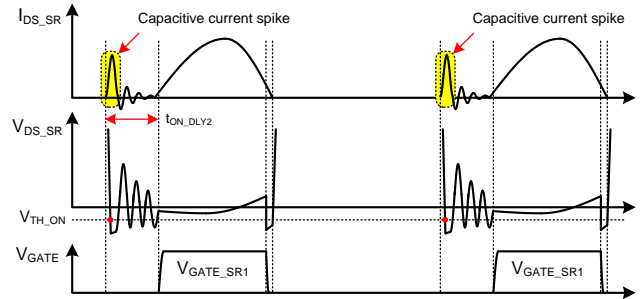

Figure 22. Capacitive current spike at light load condition

$t_{ON\_DLY}$  to  $t_{ON\_DLY2}$  in next cycle. As a result, SR mis-trigger is prevented. To exit the SR current inversion detection mode, seven consecutive switching cycles without capacitive current spike are required.

**Light Load Detection (LLD)**

To guarantee stable operation under light load condition, FAN6248 adopts a light load detection function. The modulation current  $I_{OFFSET}$  is mainly used for the adaptive dead time control. When the output load is heavy,  $I_{OFFSET\_STEP}$  declines due to large di/dt in the secondary side current to maintain 200ns of  $t_{DEAD}$ . On the contrary,  $I_{OFFSET\_STEP}$  increases at light load condition by small di/dt of SR current. FAN6248 can detect light load condition by using this  $I_{OFFSET\_STEP}$  as shown in Figure 23. When SR turn-off threshold voltage is  $V_{TH\_OFF1}$  and the modulation current becomes  $I_{OFFSET\_STEP8}$ , the light load detection is triggered. In this mode, the turn-on delay is changed to  $t_{ON\_DLY2}$  to prevent the SR inversion current, and dead time target becomes to 250ns of  $t_{DEAD\_LIGHT}$  in FAN6248HA and HB version.

**Green Mode**

When the power supply system operates at very light load condition, FAN6248 disables SR operation and enters into green mode operation. Once FAN6248 is in the green mode, all the major blocks are disabled to minimize the operating current. When  $V_{DS\_SR}$  has no switching operation long than  $t_{GRN\_ENT}$  during the burst mode of the primary side LLC controller, the green mode is enabled after  $t_{GRN\_ENT\_DBNC}$  of debounce time. After then, FAN6248 exits the green mode when the non-switching time in the burst mode is less than  $t_{GRN\_EXT\_H}$  or 11 consecutive switching cycles are detected as shown in Figure 24.

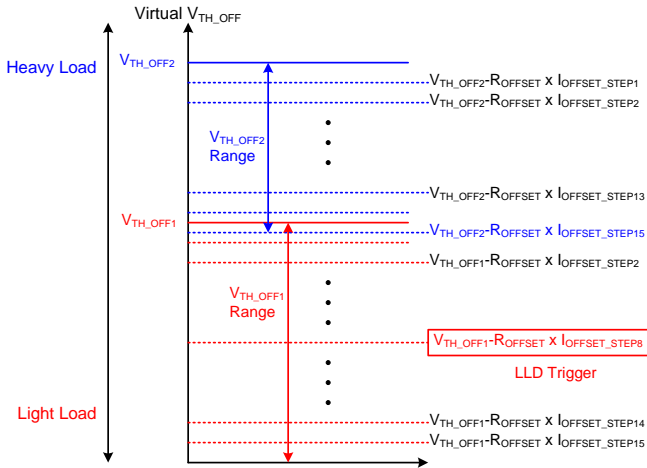

Figure 23. Light load detection

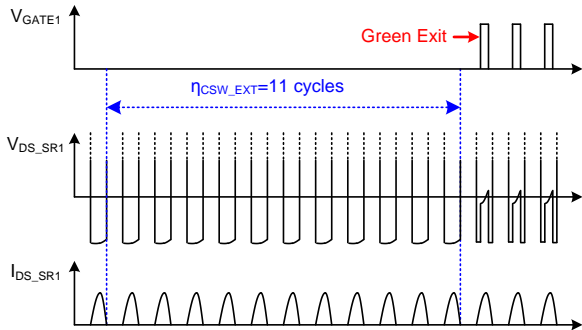
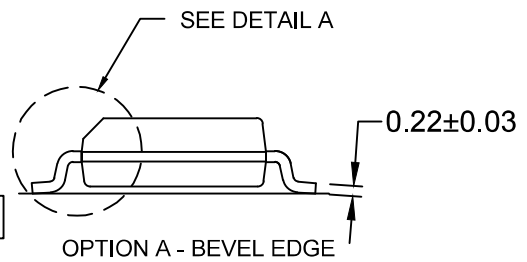
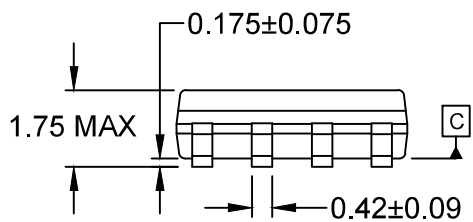

Figure 24. Green mode exit



NOTES:

- A) THIS PACKAGE CONFORMS TO JEDEC MS-012, VARIATION AA.
- B) ALL DIMENSIONS ARE IN MILLIMETERS.
- C) DIMENSIONS DO NOT INCLUDE MOLD FLASH OR BURRS.
- D) LANDPATTERN STANDARD: SOIC127P600X175-8M
- E) DRAWING FILENAME: M08Arev16



ON Semiconductor and  are trademarks of Semiconductor Components Industries, LLC dba ON Semiconductor or its subsidiaries in the United States and/or other countries. ON Semiconductor owns the rights to a number of patents, trademarks, copyrights, trade secrets, and other intellectual property. A listing of ON Semiconductor's product/patent coverage may be accessed at [www.onsemi.com/site/pdf/Patent-Marking.pdf](http://www.onsemi.com/site/pdf/Patent-Marking.pdf). ON Semiconductor reserves the right to make changes without further notice to any products herein. ON Semiconductor makes no warranty, representation or guarantee regarding the suitability of its products for any particular purpose, nor does ON Semiconductor assume any liability arising out of the application or use of any product or circuit, and specifically disclaims any and all liability, including without limitation special, consequential or incidental damages. Buyer is responsible for its products and applications using ON Semiconductor products, including compliance with all laws, regulations and safety requirements or standards, regardless of any support or applications information provided by ON Semiconductor. "Typical" parameters which may be provided in ON Semiconductor data sheets and/or specifications can and do vary in different applications and actual performance may vary over time. All operating parameters, including "Typicals" must be validated for each customer application by customer's technical experts. ON Semiconductor does not convey any license under its patent rights nor the rights of others. ON Semiconductor products are not designed, intended, or authorized for use as a critical component in life support systems or any FDA Class 3 medical devices or medical devices with a same or similar classification in a foreign jurisdiction or any devices intended for implantation in the human body. Should Buyer purchase or use ON Semiconductor products for any such unintended or unauthorized application, Buyer shall indemnify and hold ON Semiconductor and its officers, employees, subsidiaries, affiliates, and distributors harmless against all claims, costs, damages, and expenses, and reasonable attorney fees arising out of, directly or indirectly, any claim of personal injury or death associated with such unintended or unauthorized use, even if such claim alleges that ON Semiconductor was negligent regarding the design or manufacture of the part. ON Semiconductor is an Equal Opportunity/Affirmative Action Employer. This literature is subject to all applicable copyright laws and is not for resale in any manner.

## PUBLICATION ORDERING INFORMATION

### LITERATURE FULFILLMENT:

Literature Distribution Center for ON Semiconductor  
19521 E. 32nd Pkwy, Aurora, Colorado 80011 USA  
**Phone:** 303-675-2175 or 800-344-3860 Toll Free USA/Canada  
**Fax:** 303-675-2176 or 800-344-3867 Toll Free USA/Canada  
**Email:** [orderlit@onsemi.com](mailto:orderlit@onsemi.com)

**N. American Technical Support:** 800-282-9855 Toll Free  
USA/Canada  
**Europe, Middle East and Africa Technical Support:**  
Phone: 421 33 790 2910  
**Japan Customer Focus Center**  
Phone: 81-3-5817-1050

**ON Semiconductor Website:** [www.onsemi.com](http://www.onsemi.com)  
**Order Literature:** <http://www.onsemi.com/orderlit>  
For additional information, please contact your local  
Sales Representative



# Mouser Electronics

Authorized Distributor

Click to View Pricing, Inventory, Delivery & Lifecycle Information:

[ON Semiconductor:](#)

[FAN6248HAMX](#) [FAN6248HBMX](#)

Компания «Life Electronics» занимается поставками электронных компонентов импортного и отечественного производства от производителей и со складов крупных дистрибьюторов Европы, Америки и Азии.

С конца 2013 года компания активно расширяет линейку поставок компонентов по направлению коаксиальный кабель, кварцевые генераторы и конденсаторы (керамические, пленочные, электролитические), за счёт заключения дистрибьюторских договоров

Мы предлагаем:

- Конкурентоспособные цены и скидки постоянным клиентам.
- Специальные условия для постоянных клиентов.
- Подбор аналогов.
- Поставку компонентов в любых объемах, удовлетворяющих вашим потребностям.
- Приемлемые сроки поставки, возможна ускоренная поставка.
- Доставку товара в любую точку России и стран СНГ.
- Комплексную поставку.
- Работу по проектам и поставку образцов.
- Формирование склада под заказчика.
- Сертификаты соответствия на поставляемую продукцию (по желанию клиента).
- Тестирование поставляемой продукции.
- Поставку компонентов, требующих военную и космическую приемку.
- Входной контроль качества.
- Наличие сертификата ISO.

В составе нашей компании организован Конструкторский отдел, призванный помогать разработчикам, и инженерам.

Конструкторский отдел помогает осуществить:

- Регистрацию проекта у производителя компонентов.
- Техническую поддержку проекта.
- Защиту от снятия компонента с производства.
- Оценку стоимости проекта по компонентам.
- Изготовление тестовой платы монтаж и пусконаладочные работы.

