

# Cree® 5-mm Blue and Green Round LED

## C503B-BCS/BCN-030

## C503B-GCS/GCN-030

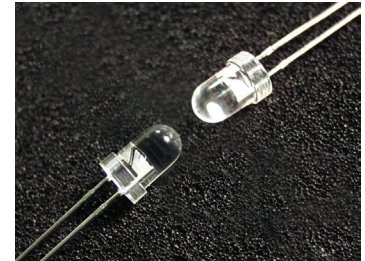

### PRODUCT DESCRIPTION

Round LEDs offer superior light output for excellent readability in sunlight and dependable performance. They provide extremely stable light output over long periods of time.

These lamps are made with an advanced optical-grade epoxy offering superior high-temperature and high-moisture-resistance performance in outdoor signal and sign applications.

### FEATURES

- Size (mm): 5
- Color and Typical Dominant Wavelength:  
Blue (470nm)  
Green(527nm)
- Luminous Intensity (mcd)  
C503B-BCS/BCN-030:  
(1520-8200)  
C503B-GCS/GCN-030:  
(5860-23500)
- Viewing angle:  
C503B-BCS/BCN/GCS/GCN-030:  
30 degree minimum
- Lead - Free
- RoHS Compliant

### APPLICATIONS

- Electronic Signs & Signals (ESS)
- Motorway Signs
- Variable Message Sign (VMS)
- Advertising signs
- Petrol Signs
- Amusement

### ABSOLUTE MAXIMUM RATINGS ( $T_A = 25^\circ\text{C}$ )

Items	Symbol	Absolute Maximum Rating	Unit
		Blue/Green	
Forward Current	$I_F$	30	mA
Peak Forward Current <sup>Note1</sup>	$I_{FP}$	100	mA
Reverse Voltage	$V_R$	5	V
Power Dissipation	$P_D$	120	mW
Operation Temperature	$T_{opr}$	-40 ~ +95	$^\circ\text{C}$
Storage Temperature	$T_{stg}$	-40 ~ +100	$^\circ\text{C}$
Lead Soldering Temperature	$T_{sol}$	Max. 260 $^\circ\text{C}$ for 3 sec. max. (3 mm from the base of the epoxy bulb)	

**Note:**

1. Pulse width  $\leq 0.1$  msec, duty  $\leq 1/10$ .

### TYPICAL ELECTRICAL & OPTICAL CHARACTERISTICS ( $T_A = 25^\circ\text{C}$ )

Characteristics	Color		Symbol	Condition	Unit	Minimum	Typical	Maximum
Forward Voltage	Blue/Green		$V_F$	$I_F = 20$ mA	V		3.2	3.6
Reverse Current	Blue/Green		$I_R$	$V_R = 5$ V	$\mu\text{A}$			100
Dominant Wavelength	Blue		$\lambda_D$	$I_F = 20$ mA	nm	465	470	480
	Green		$\lambda_D$	$I_F = 20$ mA	nm	520	527	535
Luminous Intensity	Blue	C503B-BCS/BCN-030	$I_V$	$I_F = 20$ mA	mcd	1520	4100	
	Green	C503B-GCS/GCN-030	$I_V$	$I_F = 20$ mA	mcd	5860	12500	
50% Power Angle	C503B-BCS/BCN/GCS/GCN-030		$2\theta_{1/2}$	$I_F = 20$ mA	deg	30		

## INTENSITY BIN LIMIT ( $I_F = 20 \text{ mA}$ )

Blue

C503B-BCS/BCN-030 (30 degree min)

Bin Code	Min.(mcd)	Max.(mcd)	Bin Code	Min.(mcd)	Max.(mcd)
U0	1520	2130	Ua	1520	1824
			Ub	1824	2130
V0	2130	3000	Va	2130	2564
			Vb	2564	3000
W0	3000	4180	Wa	3000	3590
			Wb	3590	4180
X0	4180	5860	Xa	4180	5020
			Xb	5020	5860
Y0	5860	8200	Ya	5860	7030
			Yb	7030	8200

Green

C503B-GCS/GCN-030 (30 degree min)

Bin Code	Min.(mcd)	Max.(mcd)	Bin Code	Min.(mcd)	Max.(mcd)
Y0	5860	8200	Ya	5860	7030
			Yb	7030	8200
Z0	8200	12000	Za	8200	10100
			Zb	10100	12000
A0	12000	16800	Aa	12000	14400
			Ab	14400	16800
B0	16800	23500	Ba	16800	20150
			Bb	20150	23500

- Tolerance of measurement of luminous intensity is  $\pm 15\%$

## COLOR BIN LIMIT ( $I_F = 20 \text{ mA}$ )

Blue

Bin Code	Min.(nm)	Max.(nm)
B4	465	470
B45	467.5	472.5
B5	470	475
B67	472.5	477.5
B6	475	480

Green

Bin Code	Min.(nm)	Max.(nm)
G7	520	525
G23	522.5	527.5
G8	525	530
G45	527.5	532.5
G9	530	535

- Tolerance of measurement of dominant wavelength is  $\pm 1 \text{ nm}$

## ORDER CODE TABLE\*

Blue (30 degree min)

Color	Kit Number	Viewing Angle	Luminous Intensity (mcd)		Dominant Wavelength				Package	Standoff
			Min.	Max.	Color Bin	Min. (nm)	Color Bin	Max. (nm)		
Blue	C503B-BCS-CU0Y0461-030	30	1520	8200	B4	465	B6	480	Bulk	Yes
Blue	C503B-BCS-CU0W0451-030	30	1520	4180	B4	465	B5	475	Bulk	Yes
Blue	C503B-BCS-CW0Y0451-030	30	3000	8200	B4	465	B5	475	Bulk	Yes
Blue	C503B-BCS-CU0Y0462-030	30	1520	8200	B4	465	B6	480	Ammo	Yes
Blue	C503B-BCS-CU0W0452-030	30	1520	4180	B4	465	B5	475	Ammo	Yes
Blue	C503B-BCS-CW0Y0452-030	30	3000	8200	B4	465	B5	475	Ammo	Yes
Blue	C503B-BCN-CU0Y0461-030	30	1520	8200	B4	465	B6	480	Bulk	No
Blue	C503B-BCN-CU0W0451-030	30	1520	4180	B4	465	B5	475	Bulk	No
Blue	C503B-BCN-CW0Y0451-030	30	3000	8200	B4	465	B5	475	Bulk	No
Blue	C503B-BCN-CU0Y0462-030	30	1520	8200	B4	465	B6	480	Ammo	No
Blue	C503B-BCN-CU0W0452-030	30	1520	4180	B4	465	B5	475	Ammo	No
Blue	C503B-BCN-CW0Y0452-030	30	3000	8200	B4	465	B5	475	Ammo	No

Green (30 degree min)

Color	Kit Number	Viewing Angle	Luminous Intensity (mcd)		Dominant Wavelength				Package	Standoff
			Min.	Max.	Color Bin	Min. (nm)	Color Bin	Max. (nm)		
Green	C503B-GCS-CY0B0791-030	30	5860	23500	G7	520	G9	535	Bulk	Yes
Green	C503B-GCS-CZ0B0781-030	30	8200	23500	G7	520	G8	530	Bulk	Yes
Green	C503B-GCS-CZ0B0891-030	30	8200	23500	G8	525	G9	535	Bulk	Yes
Green	C503B-GCS-CY0B0792-030	30	5860	23500	G7	520	G9	535	Ammo	Yes
Green	C503B-GCS-CZ0B0782-030	30	8200	23500	G7	520	G8	530	Ammo	Yes
Green	C503B-GCS-CZ0B0892-030	30	8200	23500	G8	525	G9	535	Ammo	Yes
Green	C503B-GCN-CY0B0791-030	30	5860	23500	G7	520	G9	535	Bulk	No
Green	C503B-GCN-CZ0B0781-030	30	8200	23500	G7	520	G8	530	Bulk	No
Green	C503B-GCN-CZ0B0891-030	30	8200	23500	G8	525	G9	535	Bulk	No
Green	C503B-GCN-CY0B0792-030	30	5860	23500	G7	520	G9	535	Ammo	No
Green	C503B-GCN-CZ0B0782-030	30	8200	23500	G7	520	G8	530	Ammo	No
Green	C503B-GCN-CZ0B0892-030	30	8200	23500	G8	525	G9	535	Ammo	No

### Notes:

1. The above kit numbers represent order codes that include multiple intensity-bin and color-bin codes. Only one intensity-bin code and one color-bin code will be shipped on each bulk. Single intensity-bin code and single color-bin codes will not be orderable.
2. Please refer to the "Cree LED Lamp Reliability Test Standards" document for reliability test conditions.
3. Please refer to the "Cree LED Lamp Soldering & Handling" document for information about how to use this LED product safely.

GRAPHS

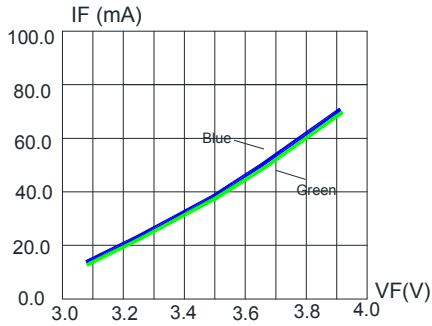

FIG.1 FORWARD CURRENT VS. FORWARD VOLTAGE.

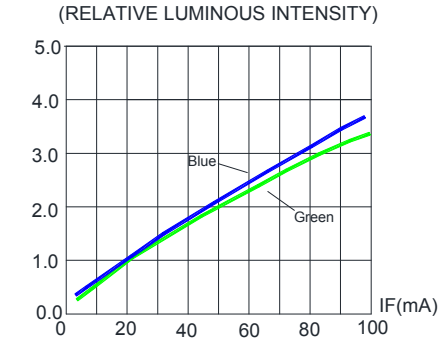

FIG.2 RELATIVE LUMINOUS INTENSITY VS. FORWARD CURRENT

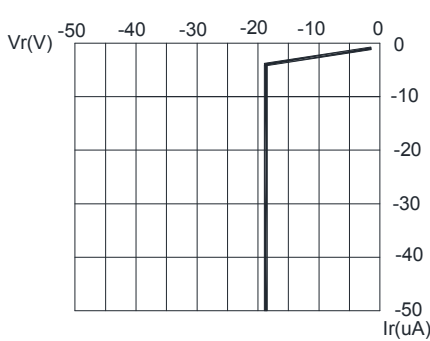

FIG.3 REVERSE CURRENT VS. REVERSE VOLTAGE.

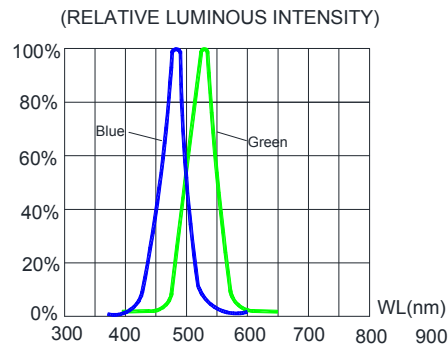

FIG.4 RELATIVE LUMINOUS INTENSITY VS. WAVELENGTH.

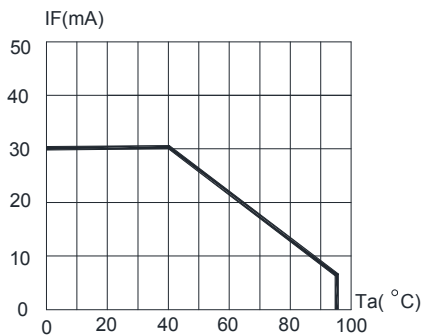

FIG.5 BLUE & GREEN MAXIMUM FORWARD DC CURRENT VS AMBIENT TEMPERATURE ( $T_{jmax}=105^{\circ}C$ )

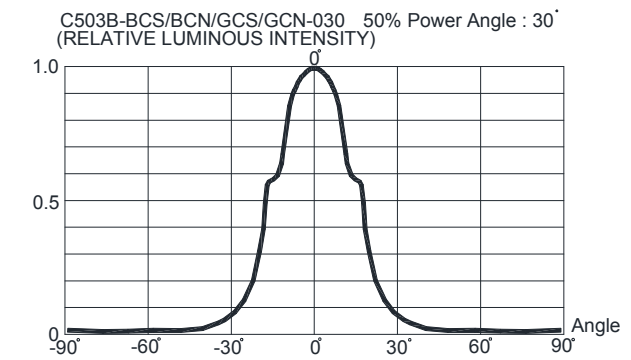

FIG.6 FAR FIELD PATTERN

The above data are collected from statistical figures that do not necessarily correspond to the actual parameters of each single LED. Hence, these data will be changed without further notice.

## MECHANICAL DIMENSIONS

All dimensions are in mm. Tolerance is  $\pm 0.25$  mm unless otherwise noted.

An epoxy meniscus may extend about 1.5 mm down the leads.

Burr around bottom of epoxy may be 0.5 mm max.

C503B-BCS/GCS-030:

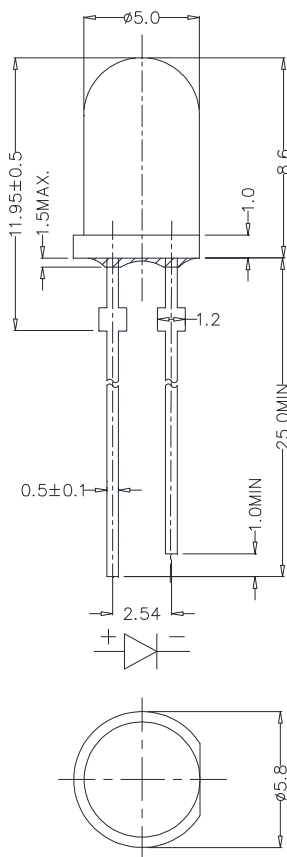

C503B-BCN/GCN-030:

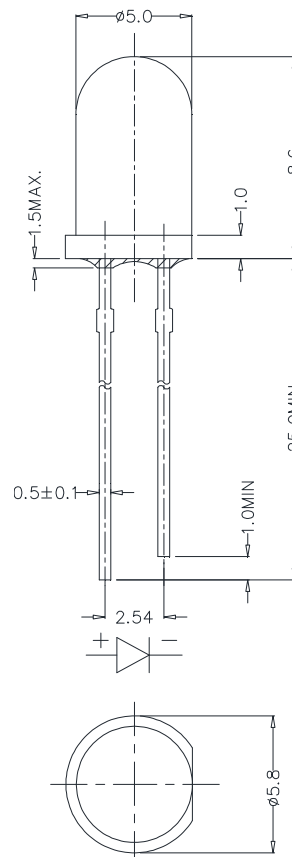

## NOTES

### RoHS Compliance

The levels of environmentally sensitive, persistent biologically toxic (PBT), persistent organic pollutants (POP), or otherwise restricted materials in this product are below the maximum concentration values (also referred to as the threshold limits) permitted for such substances, or are used in an exempted application, in accordance with EU Directive 2002/95/EC on the restriction of the use of certain hazardous substances in electrical and electronic equipment (RoHS), as amended through April 21, 2006.

### Vision Advisory Claim

Users should be cautioned not to stare at the light of this LED product. The bright light can damage the eye.

## KIT NUMBER SYSTEM

All dimensions in mm. Cree LED lamps are tested and sorted into performance bins. A bin is specified by ranges of color, forward voltage, and brightness. Sorted LEDs are packaged for shipping in various convenient options. Please refer to the "Cree LED Lamp Packaging Standard" document for more information about shipping and packaging options.

Cree LEDs are sold by order codes in combinations of bins called kits. Order codes are configured in the following manner:

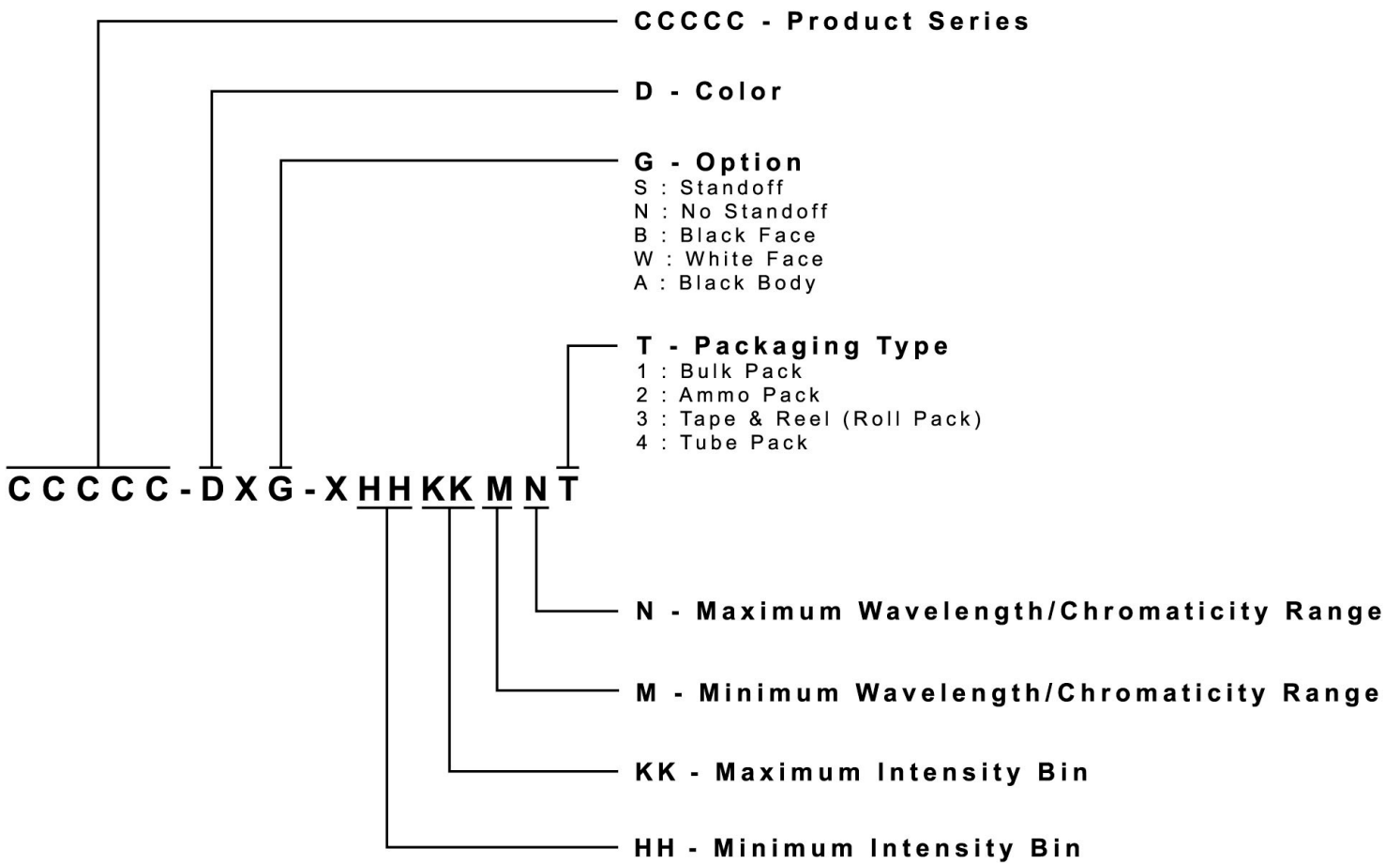

## PACKAGING

### Features:

- The LEDs are packed in cardboard boxes after packaging in normal or anti-electrostatic bags.
- Cardboard boxes will be used to protect the LEDs from mechanical shock during transportation.
- The boxes are not water resistant, and they must be kept away from water and moisture.
- The Bulk Pack types of packaging.
- Max 500 pcs per bulk and Max 2500 pcs per ammo.

### Bulk Pack Packaging Type:



### Ammo Pack Packaging Type:





Компания «Life Electronics» занимается поставками электронных компонентов импортного и отечественного производства от производителей и со складов крупных дистрибьюторов Европы, Америки и Азии.

С конца 2013 года компания активно расширяет линейку поставок компонентов по направлению коаксиальный кабель, кварцевые генераторы и конденсаторы (керамические, пленочные, электролитические), за счёт заключения дистрибьюторских договоров

Мы предлагаем:

- Конкурентоспособные цены и скидки постоянным клиентам.
- Специальные условия для постоянных клиентов.
- Подбор аналогов.
- Поставку компонентов в любых объемах, удовлетворяющих вашим потребностям.
- Приемлемые сроки поставки, возможна ускоренная поставка.
- Доставку товара в любую точку России и стран СНГ.
- Комплексную поставку.
- Работу по проектам и поставку образцов.
- Формирование склада под заказчика.
- Сертификаты соответствия на поставляемую продукцию (по желанию клиента).
- Тестирование поставляемой продукции.
- Поставку компонентов, требующих военную и космическую приемку.
- Входной контроль качества.
- Наличие сертификата ISO.

В составе нашей компании организован Конструкторский отдел, призванный помогать разработчикам, и инженерам.

Конструкторский отдел помогает осуществить:

- Регистрацию проекта у производителя компонентов.
- Техническую поддержку проекта.
- Защиту от снятия компонента с производства.
- Оценку стоимости проекта по компонентам.
- Изготовление тестовой платы монтаж и пусконаладочные работы.



Тел: +7 (812) 336 43 04 (многоканальный)

Email: [org@lifeelectronics.ru](mailto:org@lifeelectronics.ru)