

LOC		DIST		REVISIONS			
ES	00	P	LTM	DESCRIPTION	DATE	DWN	APVD
		J1		REV PER ECR-12-016975	25SEP2012	CZ	SZ
		J3		ADDED NEW DASH NUMBER 4-0	01FEB2013	CZ	SZ
		J5		ADDED NEW DASH NUMBER 4-1	25FEB2014	CZ	SZ

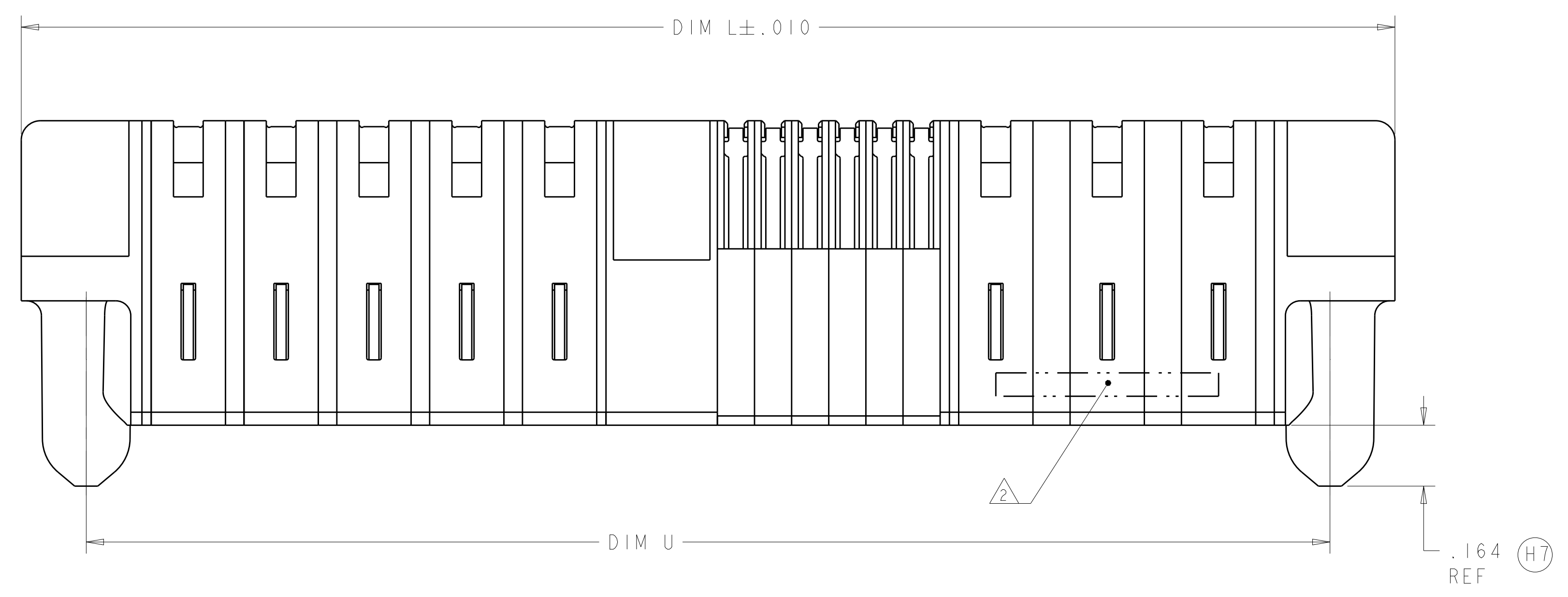

- △1 OPTIONAL CENTER MODULE, WITH .150 THRU HOLE OR HOLD DOWN FEATURE.
- △2 "AMP", PART NUMBER AND DATE CODE TO BE MARKED
- △3 MATERIAL: HOUSING - GLASS FILLED HIGH TEMP THERMO PLASTIC, UL94 V-0.
 SIGNAL CONTACT - HIGH CONDUCTIVITY COPPER ALLOY
 POWER CONTACT - HIGH CONDUCTIVITY COPPER ALLOY
- △4 CONTACT PLATING: NOBLE METAL PLATING ON CONTACT FUNCTIONAL AREA OF POWER AND SIGNAL CONTACTS
- △5 MECHANICAL CONNECTOR KEEP OUT ZONE.
- △6 DATUM AND BASIC DIMENSIONS ESTABLISHED BY CUSTOMER.
- △7 PCB - ALL HOLE DIAMETERS ARE FINISHED HOLE SIZES
- △8 PCB - .0453±.0010 DRILLED HOLES PLATED WITH .0003 MIN Sn OVER .001 TO .003 Cu PLATING TO ACHIEVE A .040 DIAMETER HOLE

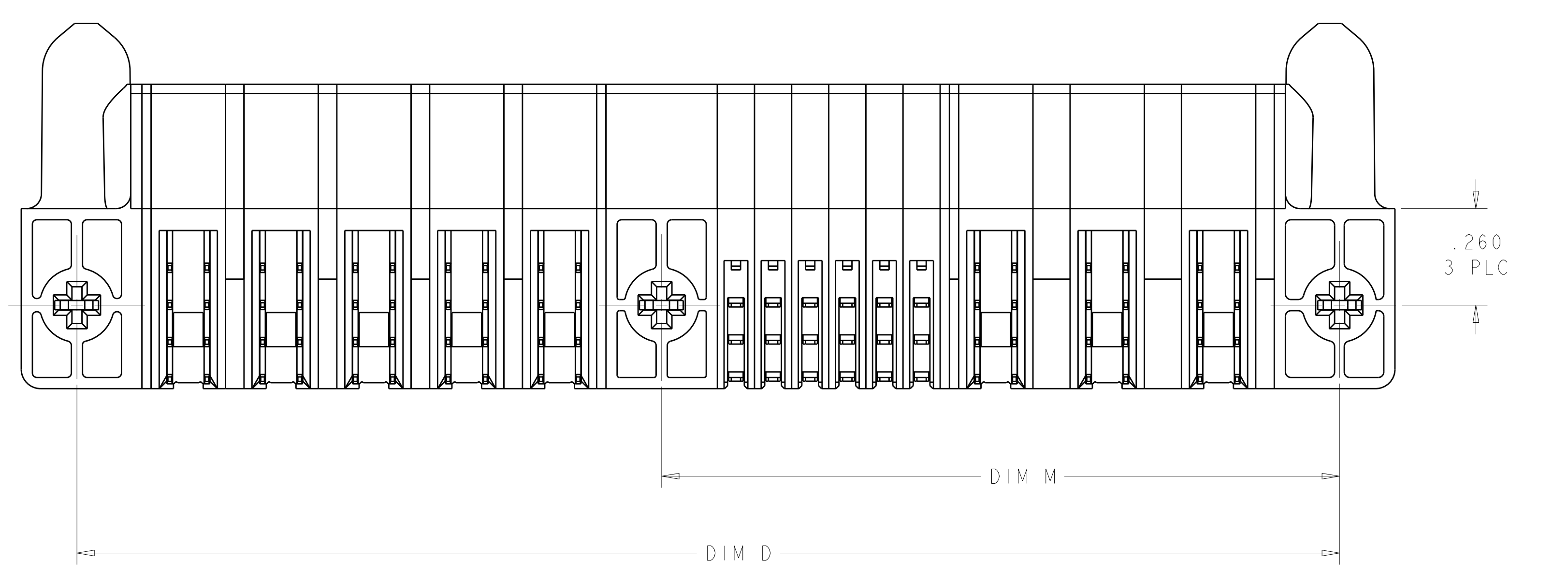
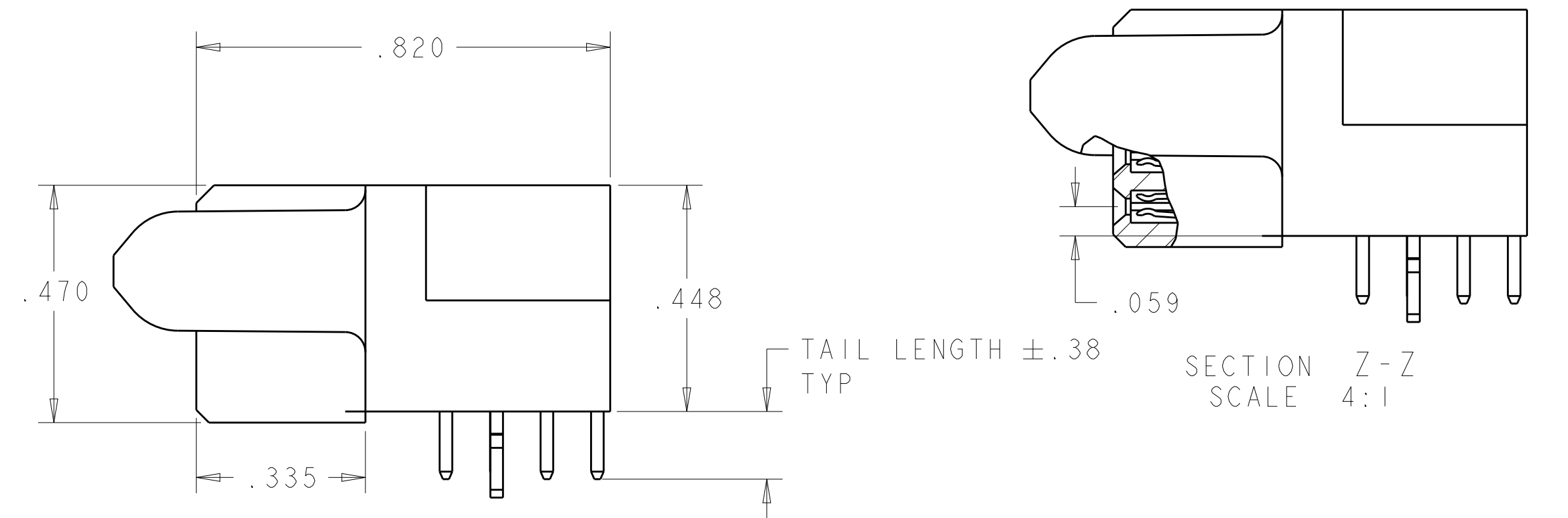
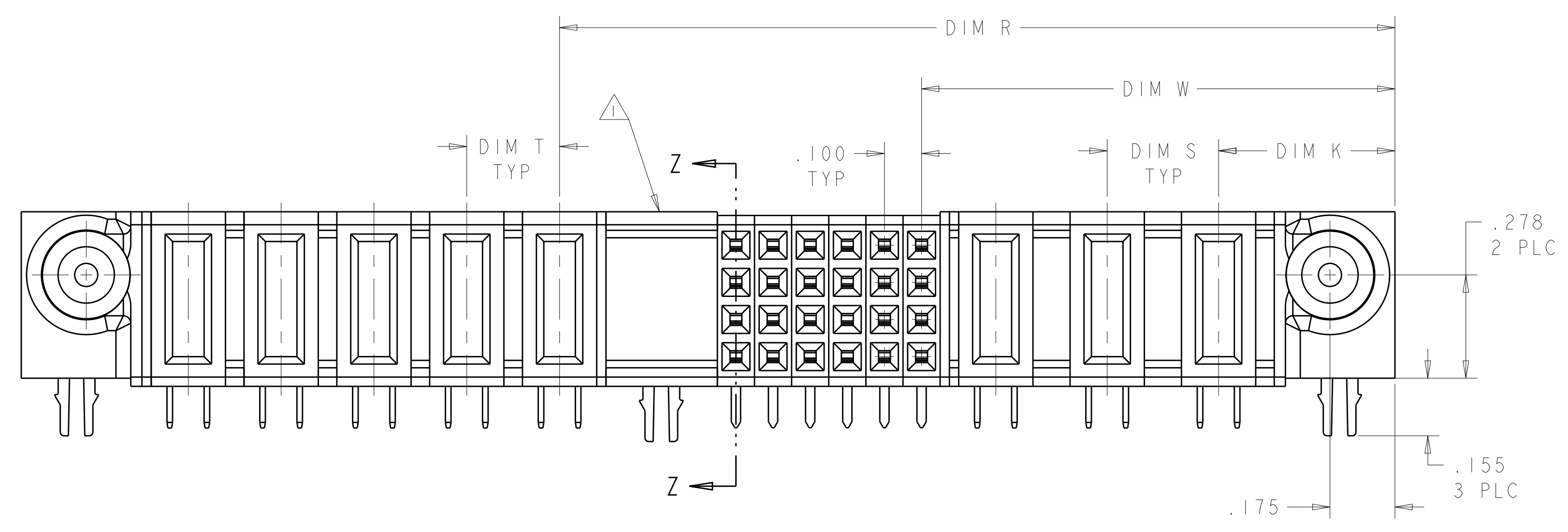

THIS DRAWING IS A CONTROLLED DOCUMENT.

DWN: R. GRZYBOWSKI 21FEB05
 CHK: M. PERCHERKE 21FEB05
 APVD: M. PERCHERKE

TE Connectivity

NAME: RIGHT ANGLE RECEPTACLE ASSEMBLY WITH GUIDES MULTI-BEAM XL

PRODUCT SPEC: 108-1973
 APPLICATION SPEC: 114-13038

SIZE: A1
 CAGE CODE: 6450170
 DRAWING NO: 100779

RESTRICTED TO: -

MATERIAL: △3
 FINISH: △4

CUSTOMER DRAWING

SCALE: 4:1 SHEET 1 OF 13 REV J5

THIS DRAWING IS UNPUBLISHED. RELEASED FOR PUBLICATION 20
 © COPYRIGHT 20 BY - ALL RIGHTS RESERVED.

LOC	DIST	REVISIONS					
		P	LTN	DESCRIPTION	DATE	DWN	APVD
ES	00	-	-	SEE SHEET 1	-	-	-

DIM U	DIM T	DIM S	DIM R	DIM W	DIM D	DIM M	DIM L	DIM K	DESCRIPTION	PART NUMBER
2.650	.200	.250	1.550	.875	2.700	-	3.000	.450	2P + 24S + 6P	4-6450170-1
3.100	.250	.250	2.250	1.875	3.150	-	3.450	.450	6P + 12S + 4P	4-6450170-0
1.900	.250	.300	1.550	1.275	1.950	-	2.250	.475	3ACP + 8S + 2P	3-6450170-9
1.800	-	-	1.700	.625	1.850	-	2.150	.450	1P + 40S + 1P	3-6450170-8
1.600	-	-	1.500	.625	1.650	-	1.950	.450	1P + 32S + 1P	3-6450170-7
1.700	.250	.250	1.350	.875	1.750	-	2.050	.450	2P + 16S + 2P	3-6450170-6
1.550	.250	.250	1.200	.900	1.600	-	1.900	.450	2P + 8S + 2P	3-6450170-5
2.350	.250	.250	1.250	.875	2.400	-	2.700	.450	2P + 12S + 5P	3-6450170-4
2.325	.250	.300	1.975	1.600	2.375	-	2.675	.450	4ACP + 12S + 2P	3-6450170-3
1.700	.250	.250	1.350	.875	1.750	-	2.050	.450	2P + 16S + 2P	3-6450170-1
2.300	.250	.300	1.950	1.275	2.350	-	2.650	.450	3ACP + 24S + 2P	3-6450170-0
2.400	.250	.250	1.800	1.125	2.450	-	2.750	.450	3P + 24S + 3P	2-6450170-9
2.300	.250	.300	1.950	1.275	2.350	-	2.650	.450	3ACP + 24S + 2P	2-6450170-8
2.400	.250	.250	1.800	1.125	2.450	-	2.750	.450	3P + 24S + 3P	2-6450170-7
1.950	.250	.250	1.600	1.125	2.000	-	2.300	.450	3P + 16S + 2P	2-6450170-6
1.300	-	-	1.200	.675	1.350	-	1.650	.450	1P + 16S + 1P	2-6450170-0
2.200	.250	.250	1.350	.875	2.250	-	2.550	.450	2P + 16S + 4P	1-6450170-9
2.800	.300	.250	2.075	1.375	2.850	-	3.150	.450	4P + 24S + 3ACP	1-6450170-8
3.000	.250	.250	2.150	1.425	3.050	-	3.350	.450	4P + 24S + 4P	1-6450170-4
2.600	.200	.200	1.925	1.175	2.650	-	2.950	.425	4P + 28S + 4P	1-6450170-1
1.575	-	-	1.425	.700	1.625	-	1.925	.475	1P + 24S + 1P	1-6450170-0
2.500	.250	.250	2.150	.875	2.550	-	2.850	.450	2P + 48S + 2P	6450170-9
3.300	.250	.300	1.950	1.275	3.350	-	3.650	.475	3ACP + 24S + 6P	6450170-8
1.400	.250	.250	1.300	.625	1.450	-	1.750	.450	1P + 24S + 1P	6450170-6
2.400	.250	.250	1.800	1.125	2.450	-	2.750	.450	3P + 24S + 3P	6450170-5
4.350	.250	.250	3.500	2.625	4.400	-	4.700	.450	9P + 32S + 4P	6450170-4
3.650	.250	.300	2.550	1.275	3.700	-	4.000	.475	3ACP + 48S + 5P	6450170-3
3.050	.250	.300	1.950	1.275	3.100	-	3.400	.475	3ACP + 24S + 5P	6450170-2
2.550	.250	.300	2.200	1.525	2.600	-	2.900	.475	3ACP + 1P + 24S + 2P	6450170-1

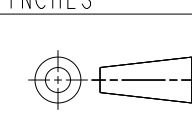
THIS DRAWING IS A CONTROLLED DOCUMENT.		DWN R. GRZYBOWSKI CHK M. PERCHERKE	Z1FEB05 Z1FEB05	 TE Connectivity NAME RIGHT ANGLE RECEPTACLE ASSEMBLY WITH GUIDES MULTI-BEAM XL
DIMENSIONS: INCHES	TOLERANCES UNLESS OTHERWISE SPECIFIED:	APVD M. PERCHERKE	PRODUCT SPEC 108-1973	
	0 PLC ±. 1 PLC ±.01 2 PLC ±.01 3 PLC ±.005 4 PLC ±.002 ANGLES ±.002 FINISH	APPLICATION SPEC 114-13038	RESTRICTED TO	
MATERIAL		WEIGHT	SCALE 4:1 SHEET 2 OF 13 REV J5	
CUSTOMER DRAWING		SIZE A100779	CAGE CODE 6450170	

NO CONTACT

PART NUMBER	ROWS	POWER				SIGNAL				POWER							
		P6	P5	P4	P3	6	5	4	3	2	1	P4	P3	P2	P1		
6450170-1	D C B A	RM	RM	RM	RM	H	H	H	H	H	H	H	H	H	RA	RM	RM
		3ACP + 1P + 24S + 2P															

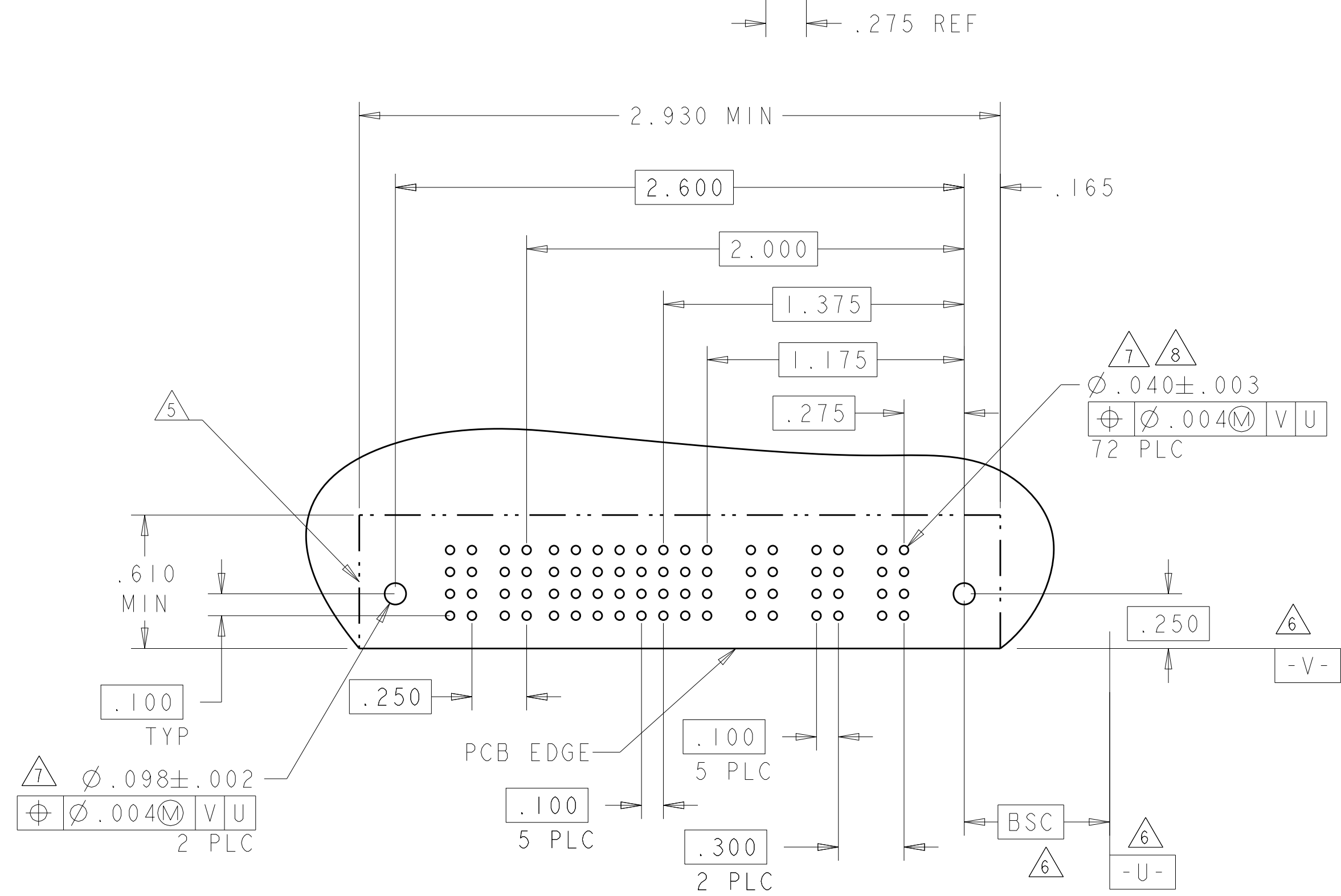

PART NUMBER	ROWS	POWER				SIGNAL				POWER							
		P8	P7	P6	P5	6	5	4	3	2	1	P3	P2	P1			
6450170-2	D C B A	RM	RM	RM	RM	H	H	H	H	H	H	H	H	H	RA	RM	RM
		3ACP + 24S + 5P															

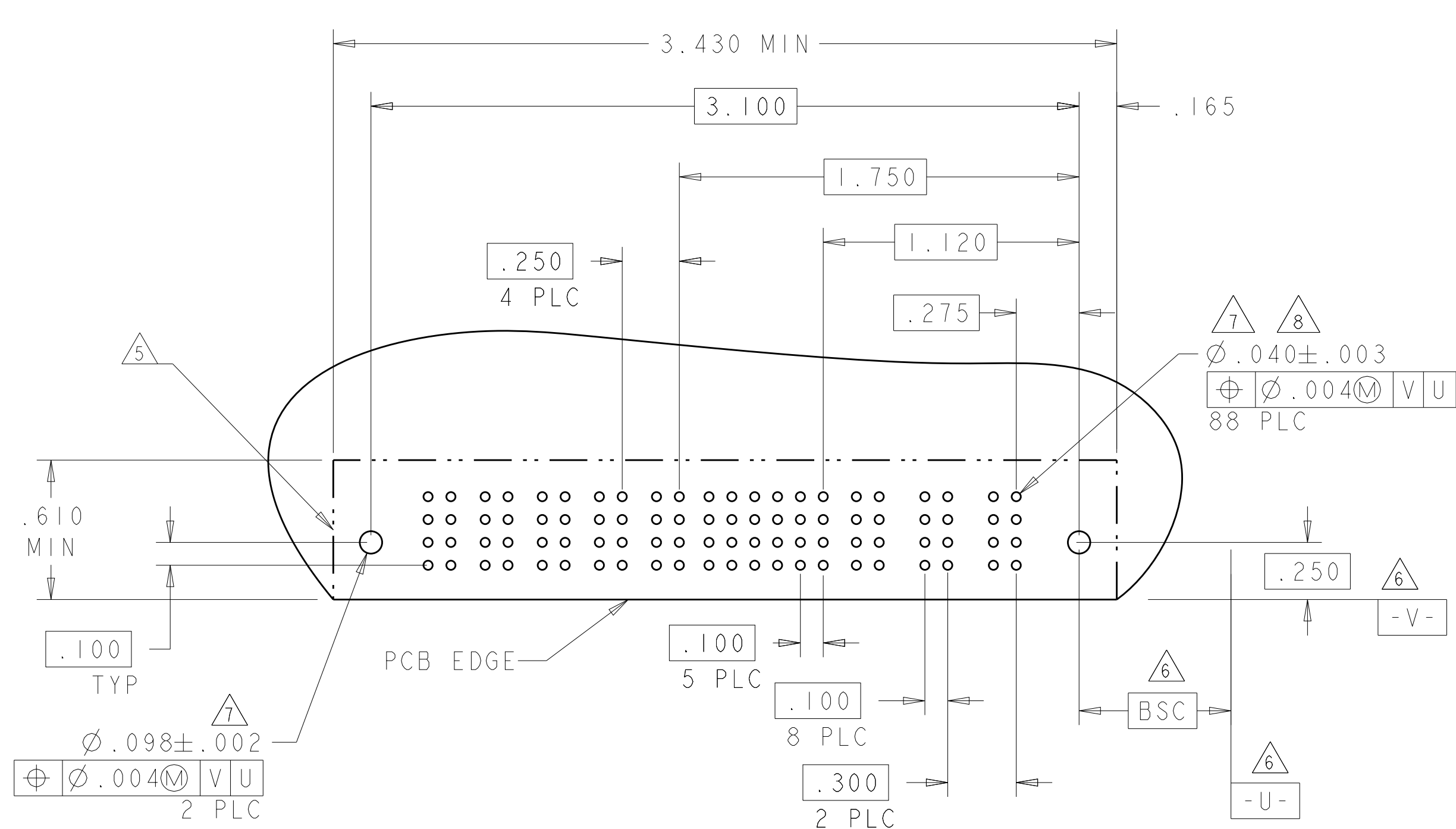

PART NUMBER	ROWS	POWER				SIGNAL												POWER								
		P8	P7	P6	P5	12	11	10	9	8	7	6	5	4	3	2	1	P3	P2	P1						
6450170-3	D C B A	RM	RM	RM	RM	H	H	H	H	H	H	H	H	H	H	H	H	H	H	H	RA	RM	RM			
		3ACP + 48S + 5P																								

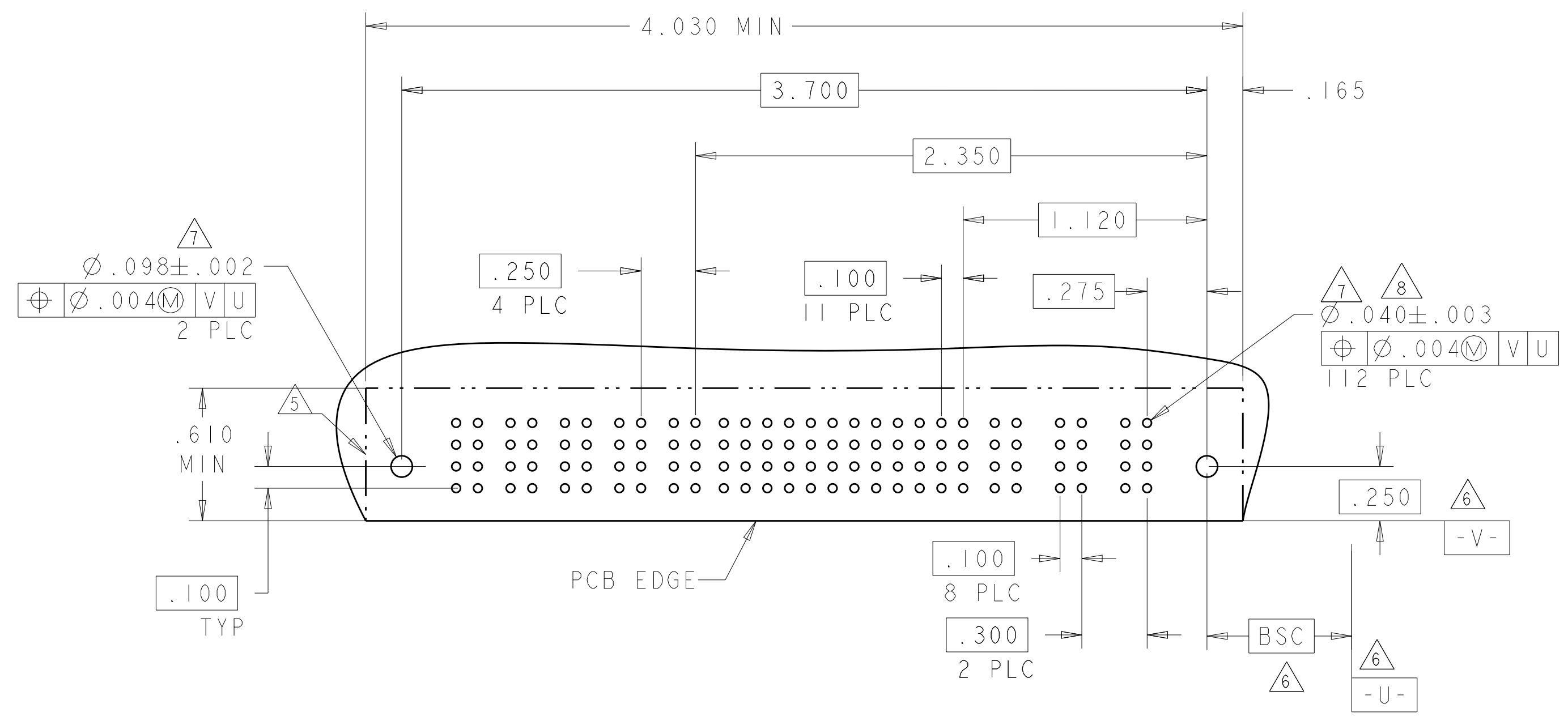

NO CONTACT

PART NUMBER	ROWS	POWER				SIGNAL												POWER										
		P13	P12	P11	P10	8	7	6	5	4	3	2	1	P9	P8	P7	P6	P5	P4	P3	P2	P1						
6450170-4	D C B A	RM	RM	RA	RM	H	H	H	H	H	H	H	H	H	H	H	H	H	H	H	H	H	RA	RM	RM			
		J ² 3c3 4P																										

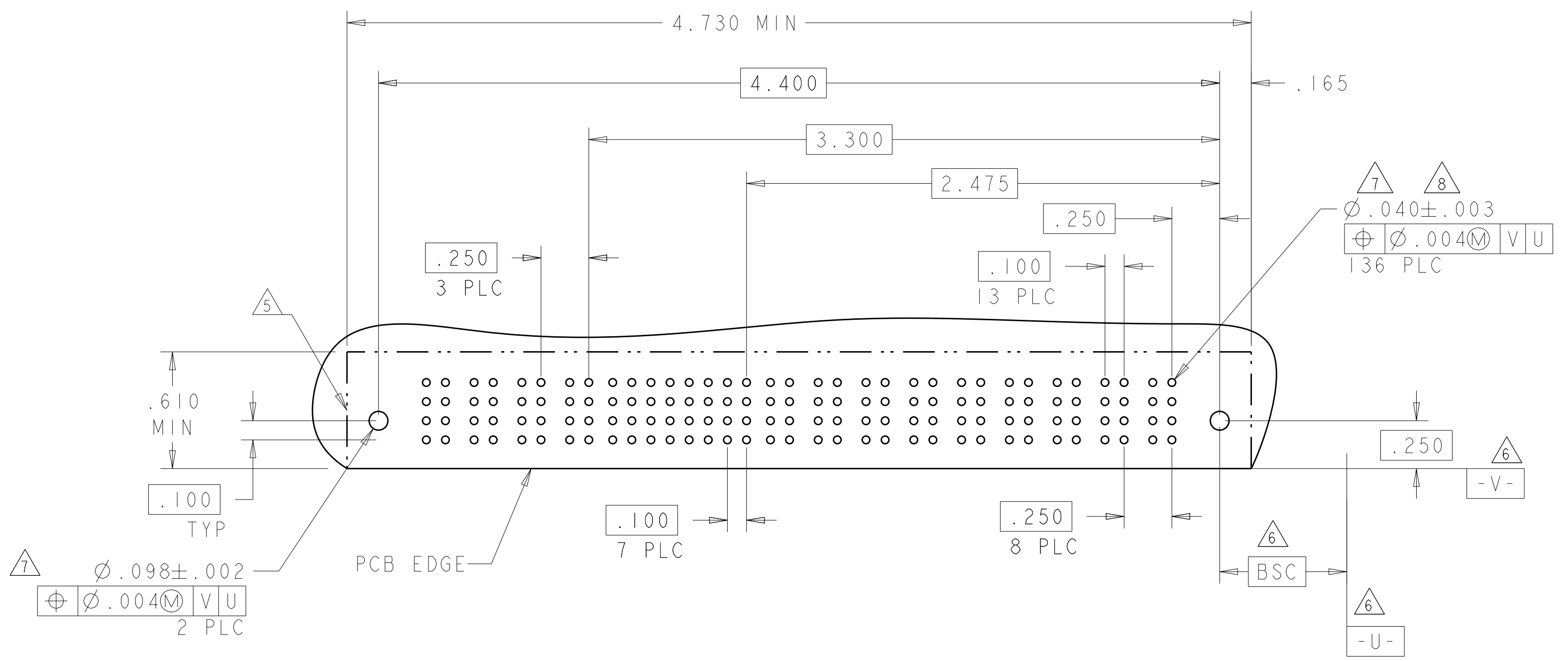

RM	.135	STD	F	.135	B
RA	.135	MFBL	E	.135	A
CODE	TAIL LENGTH	TYPE	CODE	TAIL LENGTH	ROW
POWER CONTACT			SIGNAL CONTACT		

THIS DRAWING IS A CONTROLLED DOCUMENT.

DIMENSIONS: INCHES	TOLERANCES UNLESS OTHERWISE SPECIFIED:	OWN: R. GRZYBOWSKI	21FEB05
0 PLC ±.01	1 PLC ±.01	CHK: M. PERCHERKE	21FEB05
2 PLC ±.01	3 PLC ±.01	APV: M. PERCHERKE	
4 PLC ±.002	5 PLC ±.005	PRODUCT SPEC	
ANGLES ±.020		108-1973	
		APPLICATION SPEC	
		114-13038	
		WEIGHT	
		FINISH	

NAME: RIGHT ANGLE RECEPTACLE ASSEMBLY WITH GUIDES MULTI-BEAM XL

SIZE: A1 | CAGE CODE: 6450170 | DRAWING NO: 100779 | SHEET 3 OF 13 | REV J5

SCALE: 1:1

LOC	DIST	REVISIONS			
ES	00	REV	DATE	BY	APPV
		1			
		SEE SHEET 1			

PART NUMBER	ROWS	POWER			SIGNAL					POWER				
		P6	P5	P4	6	5	4	3	2	1	P3	P2	P1	
6450170-5	D C B A	RA	RM	RM	H	H	H	H	H	H	H	RM	RM	RA
					G	G	G	G	G	G	G			
					F	F	F	F	F	F	F			
					E	E	E	E	E	E	E			

3P + 24S + 3P

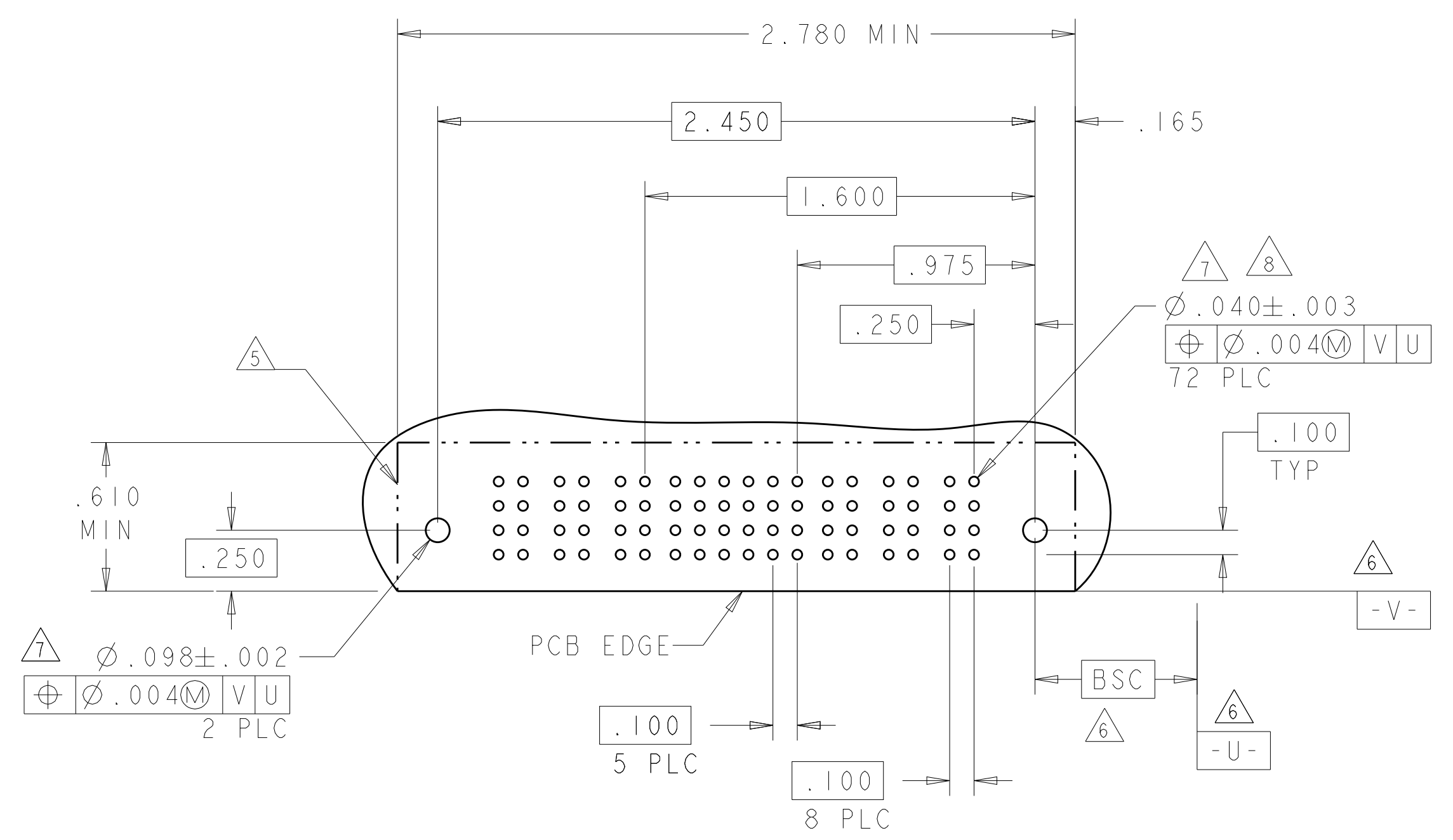

PART NUMBER	ROWS	POWER		SIGNAL					POWER			
		P2	P1	6	5	4	3	2	1	P2	P1	
6450170-6	D C B A	RB	RA	L	L	L	L	L	L	L	RM	RA
				K	K	K	K	K	K	K		
				J	J	J	J	J	J	J		
				I	I	I	I	I	I	I		

1P + 24S + 1P

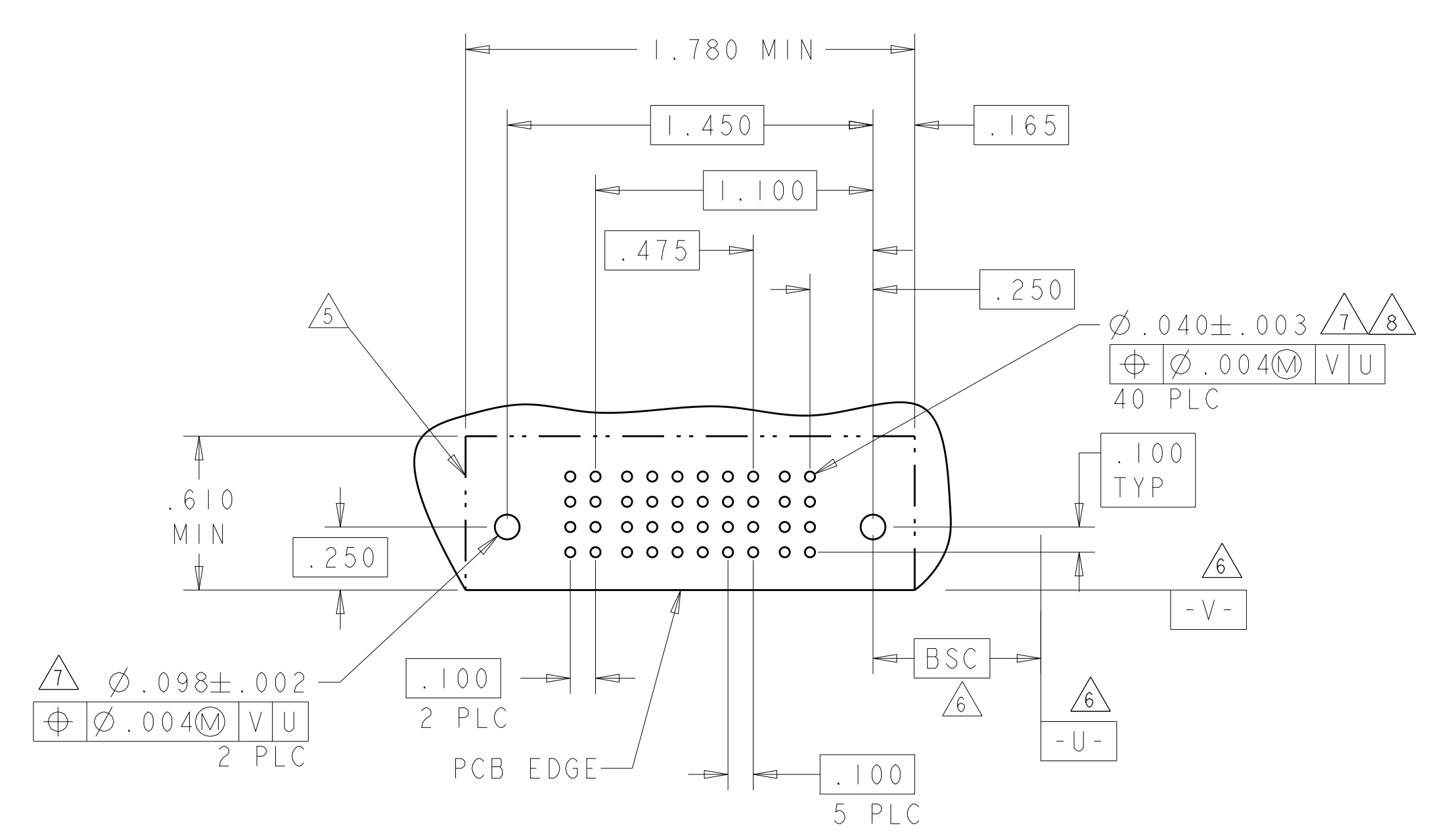

PART NUMBER	ROWS	POWER					SIGNAL					POWER			
		P9	P8	P7	P6	P5	6	5	4	3	2	1	P3	P2	P1
6450170-8	D C B A	RM	RM	RM	RM	RM	H	H	H	H	H	H	RA	RM	RM
							G	G	G	G	G	G			
							F	F	F	F	F	F			
							E	E	E	E	E	E			

3ACP + 24S + 6P

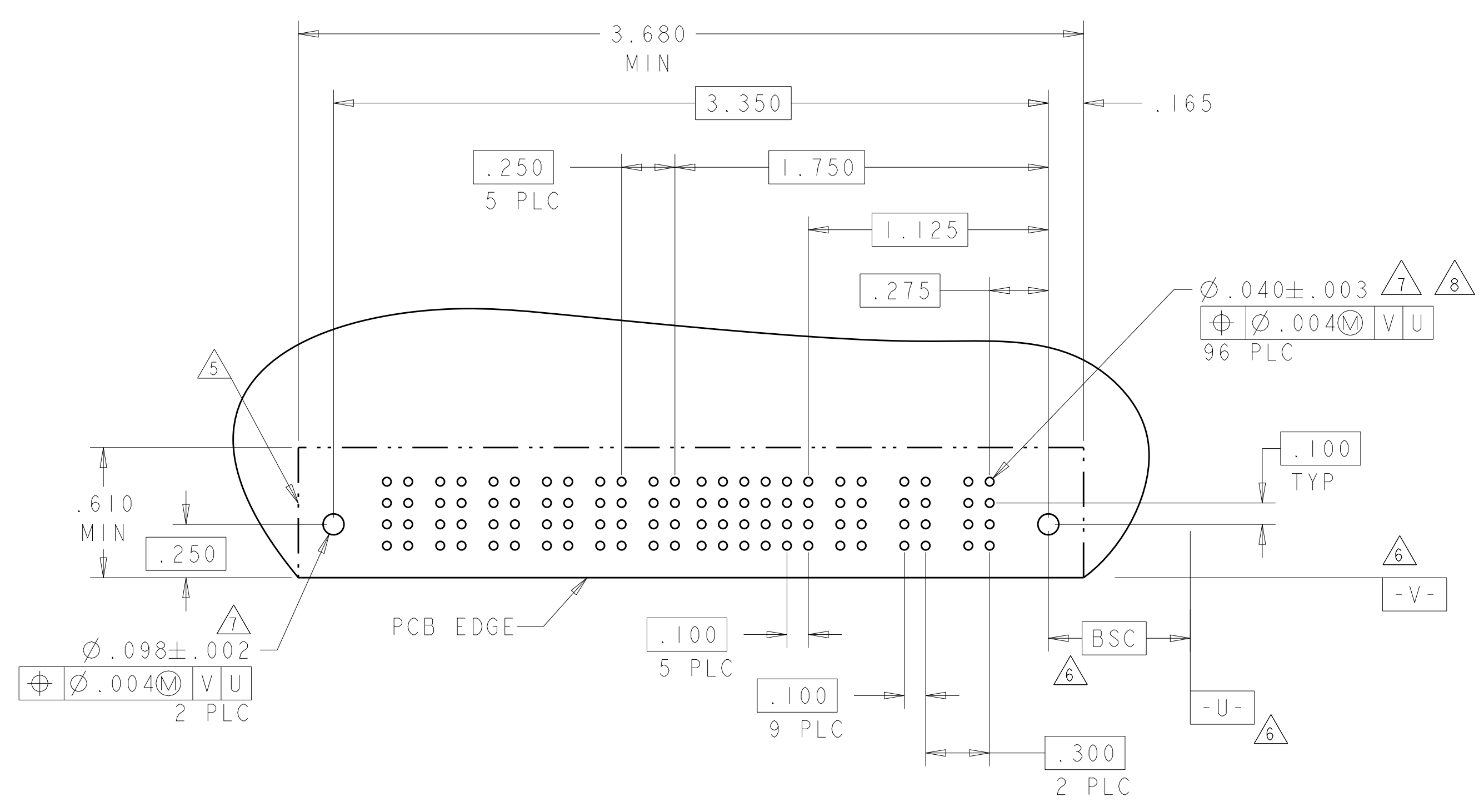

PART NUMBER	ROWS	POWER		SIGNAL										POWER			
		P4	P3	12	11	10	9	8	7	6	5	4	3	2	1	P2	P1
6450170-9	D C B A	RM	RA	H	H	H	H	H	H	H	H	H	H	H	H	RM	RA
				G	G	G	G	G	G	G	G	G	G	G			
				F	F	F	F	F	F	F	F	F	F	F			
				E	E	E	E	E	E	E	E	E	E	E			

2P + 48S + 2P

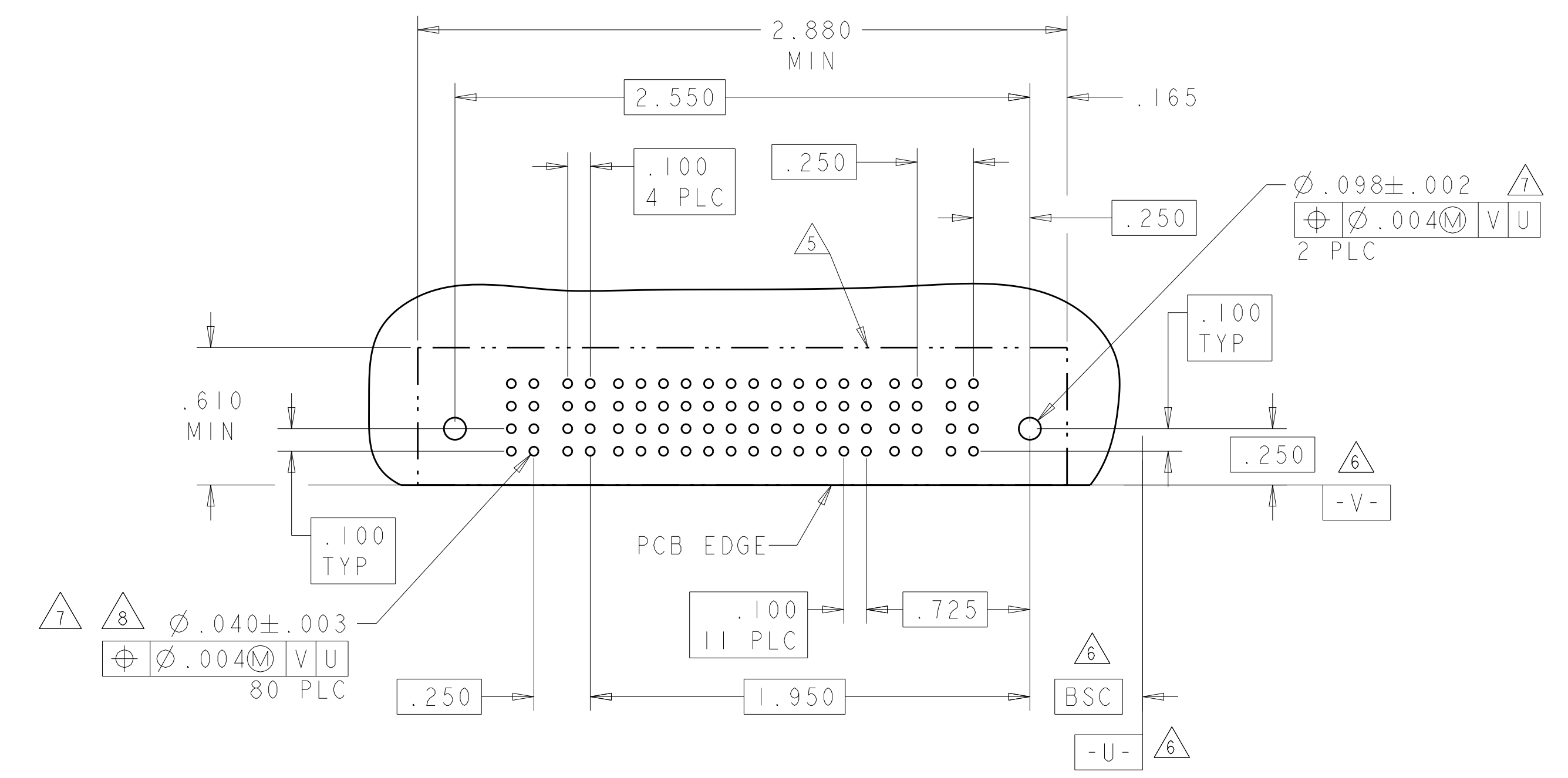

THIS DRAWING IS A CONTROLLED DOCUMENT.

DIMENSIONS:	TOLERANCES UNLESS OTHERWISE SPECIFIED:	DRN: R. GRZYBOWSKI	21FEB05
INCHES	0 PLC ±.01	CHK: M. PERCHERKE	21FEB05
	1 PLC ±.01	APPV: M. PERCHERKE	
	2 PLC ±.01	PRODUCT SPEC	
	3 PLC ±.01	108-1973	
	4 PLC ±.005	APPLICATION SPEC	
	5 PLC ±.002	114-13038	
	ANGLES ±.020	WEIGHT	
MATERIAL	FINISH	CUSTOMER DRAWING	

NAME: RIGHT ANGLE RECEPTACLE ASSEMBLY WITH GUIDES MULTI-BEAM XL

SIZE: 4:1 SCALE SHEET 4 OF 13 REV J5

LOC	DIST	REVISIONS			
ES	00	REV	DATE	BY	APPV
		1			
		2			

PART NUMBER	ROWS	POWER						SIGNAL						POWER				
		P2	6	5	4	3	2	1	P1	6	5	4	3	2	1	P3	P2	P1
1-6450170-0	D C B A	RM	H	H	H	H	H	H	G	G	G	G	G	G	G	RA	RA	RA
		RM	F	F	F	F	F	F	E	E	E	E	E	E	E			

IP + 24S + IP

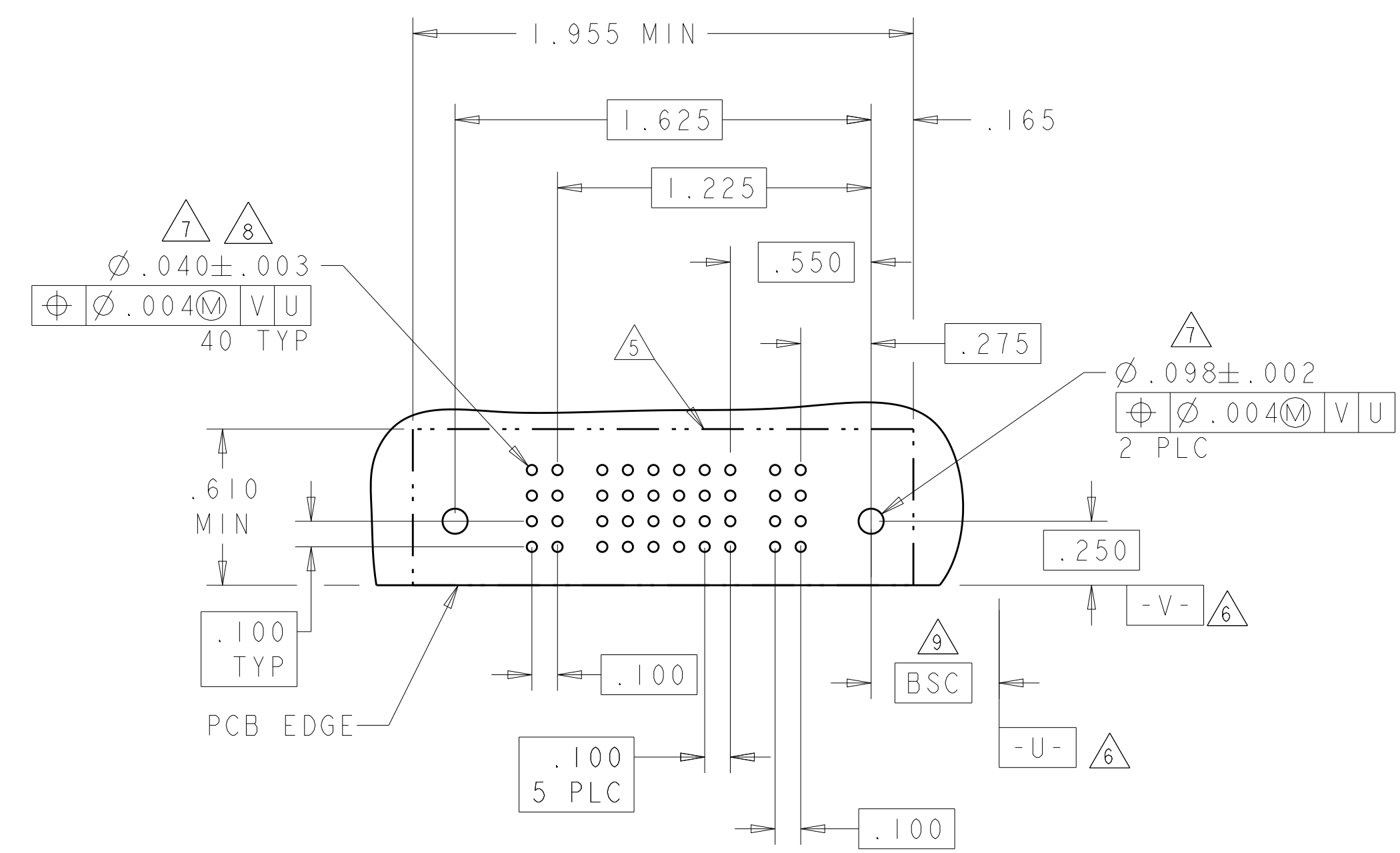

PART NUMBER	ROWS	POWER								SIGNAL								POWER				
		P8	P7	P6	P5	7	6	5	4	3	2	1	P4	P3	P2	P1	P3	P2	P1			
1-6450170-1	D C B A	RM	RM	RM	RM	H	H	H	H	H	H	H	G	G	G	G	G	G	G	RM	RM	RM
		RM	RM	RM	RM	F	F	F	F	F	F	F	E	E	E	E	E	E	E			

4P + 28S + 4P

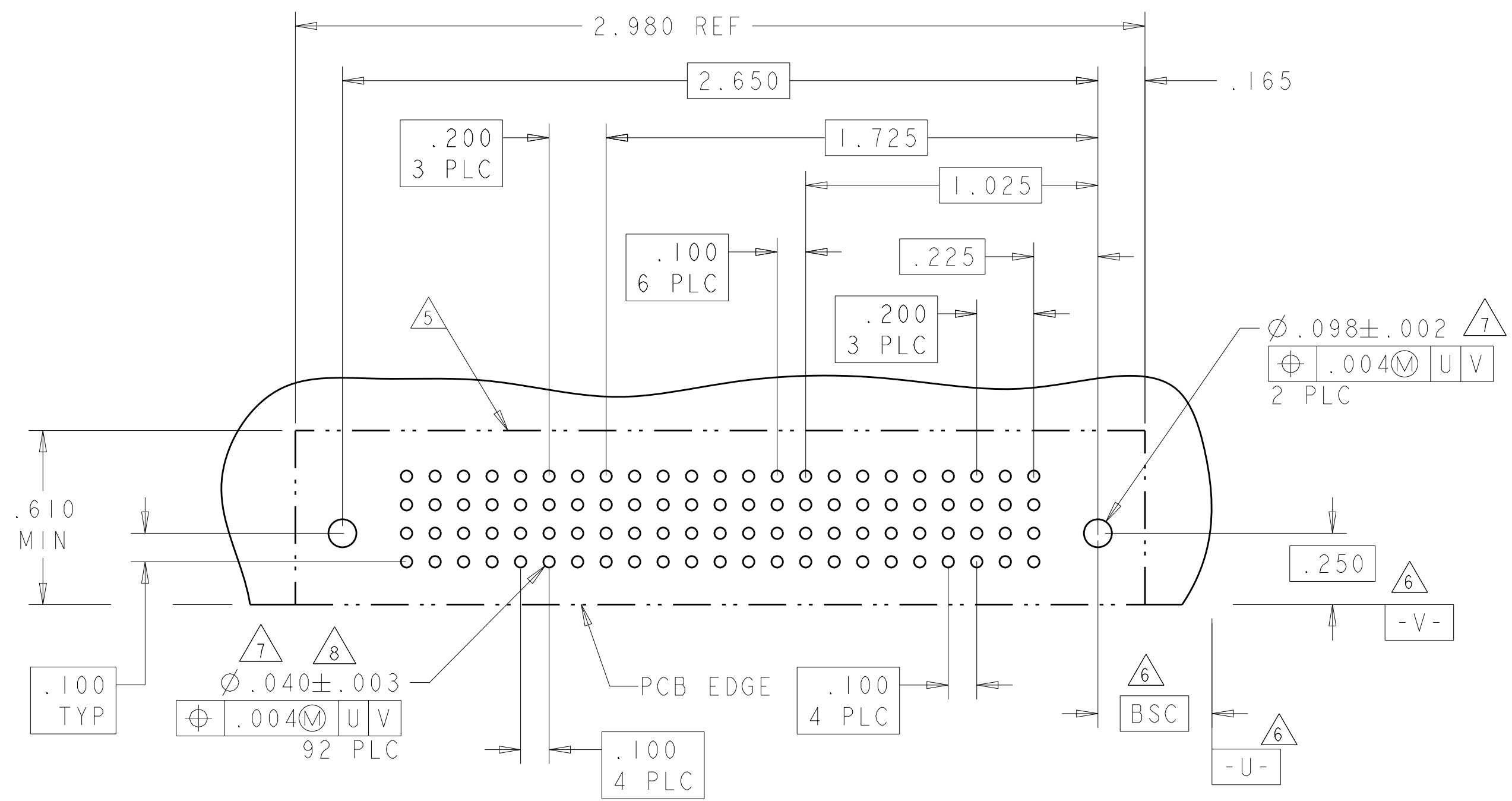

PART NUMBER	ROWS	POWER				SIGNAL				POWER				
		P5	P4	4	3	2	1	P3	P2	P1				
2-6450170-6	D C B A	RM	RM	H	H	H	H	G	G	G	G	RA	RA	RA
		RM	RM	F	F	F	F	E	E	E	E			

3P + 16S + 2P

NO CONTACTS LOADED

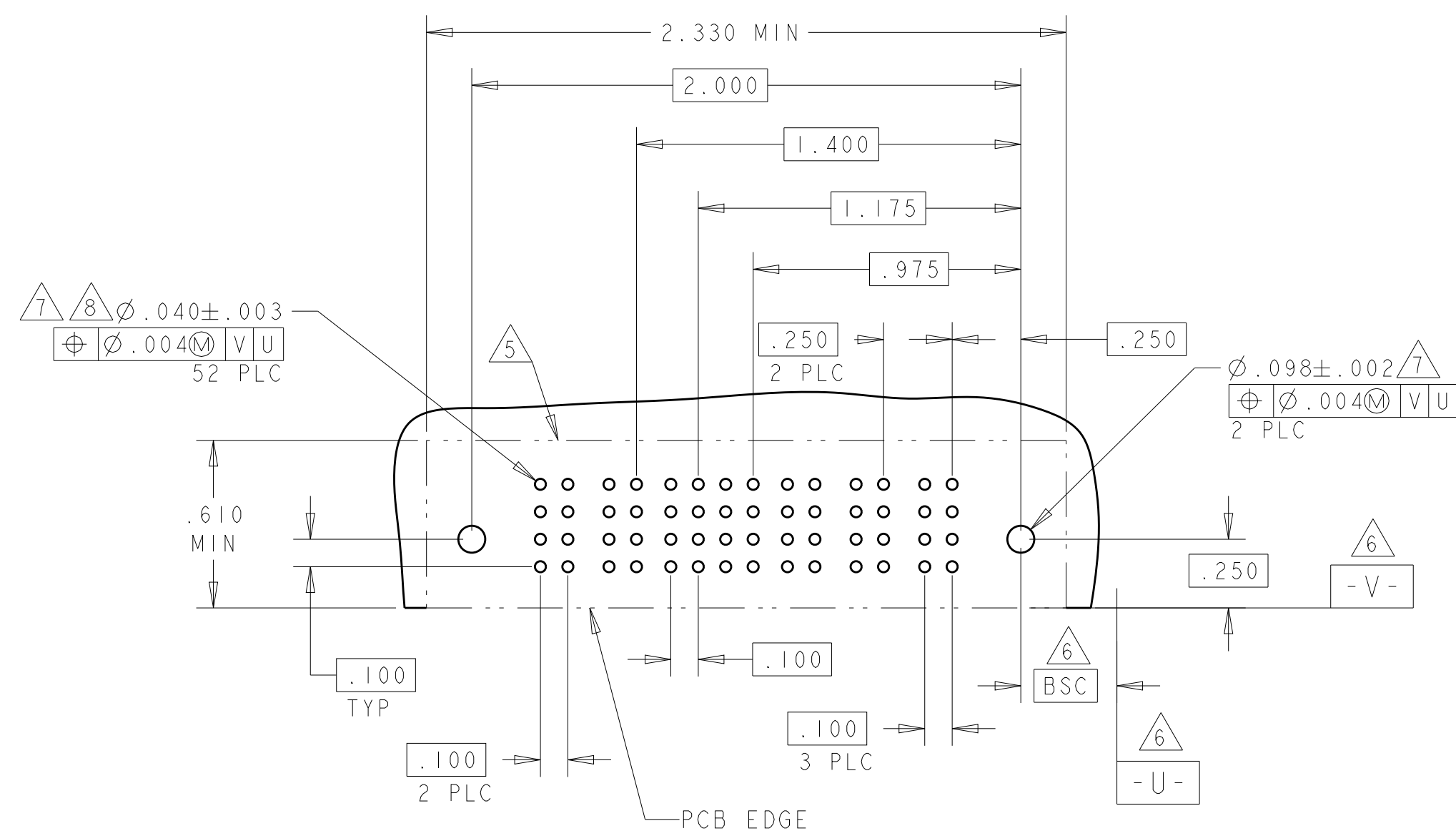

PART NUMBER	ROWS	POWER						SIGNAL						POWER		
		P6	P5	P4	6	5	4	3	2	1	P3	P2	P1	P3	P2	P1
2-6450170-7	D C B A	RM	RM	RA	H	H	H	H	G	G	G	G	RM	RM		
		RM	RM	RA	F	F	F	F	E	E	E	E				

3P + 24S + 3P

PART NUMBER	ROWS	POWER						SIGNAL						POWER		
		P6	P5	P4	6	5	4	3	2	1	P3	P2	P1	P3	P2	P1
2-6450170-9	D C B A	RM	RM	RA	H	H	H	H	G	G	G	G	RM	RM		
		RM	RM	RA	F	F	F	F	E	E	E	E				

3P + 24S + 3P

NO CONTACTS LOADED

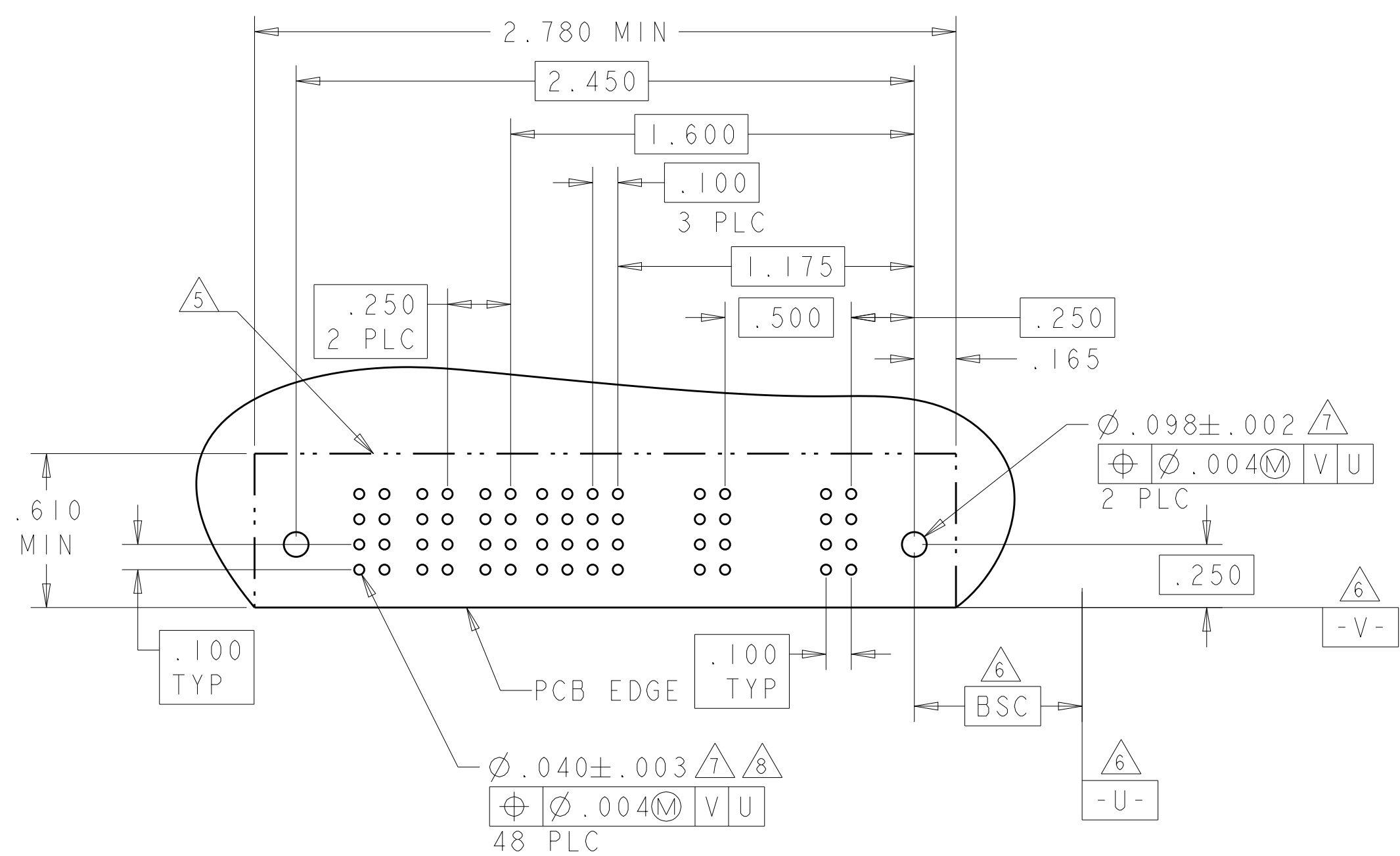

2-6450170-7 & 2-6450170-9 PCB LAYOUT

THIS DRAWING IS A CONTROLLED DOCUMENT.		OWN: R. GRZYBOWSKI 21FE805	TE Connectivity
DIMENSIONS: INCHES		CHK: M. PERCHERKE	
TOLERANCES UNLESS OTHERWISE SPECIFIED:		APVD: M. PERCHERKE	NAME: RIGHT ANGLE RECEPTACLE ASSEMBLY WITH GUIDES MULTI-BEAM XL
0 PLC ±.01 1 PLC ±.01 2 PLC ±.01 3 PLC ±.005 4 PLC ±.002 ANGLES ±.020		PRODUCT SPEC: 108-1973	SIZE: 114-13038
MATERIAL: FINISH:		APPLICATION SPEC: 114-13038	RESTRICTED TO: A100779
		WEIGHT: 114-13038	CUSTOMER DRAWING: SCALE 4:1 SHEET 5 OF 13 REV J5

LOC	DIST	REVISIONS			
P	LTN	DESCRIPTION	DATE	OWN	APVD
ES	00	SEE SHEET 1			

PART NUMBER	ROWS	POWER		SIGNAL				POWER		
		P2	P1	4	3	2	1	P1	P2	
2-6450170-0	D C B A	RM	RM	H	H	H	H	RM	RM	RM
				G	G	G	G			
				F	F	F	F			
IP + 16S + IP				E	E	E	E			

PART NUMBER	ROWS	POWER		SIGNAL						AC POWER				
		P5	P4	6	5	4	3	2	1	P3	P2	P1		
3-6450170-0	D C B A	RM	RM	H	H	H	H	H	H	RM	RM	RM	RM	RM
				G	G	G	G	G	G					
				F	F	F	F	F	F					
3ACP + 24S + 2P				E	E	E	E	E	E					

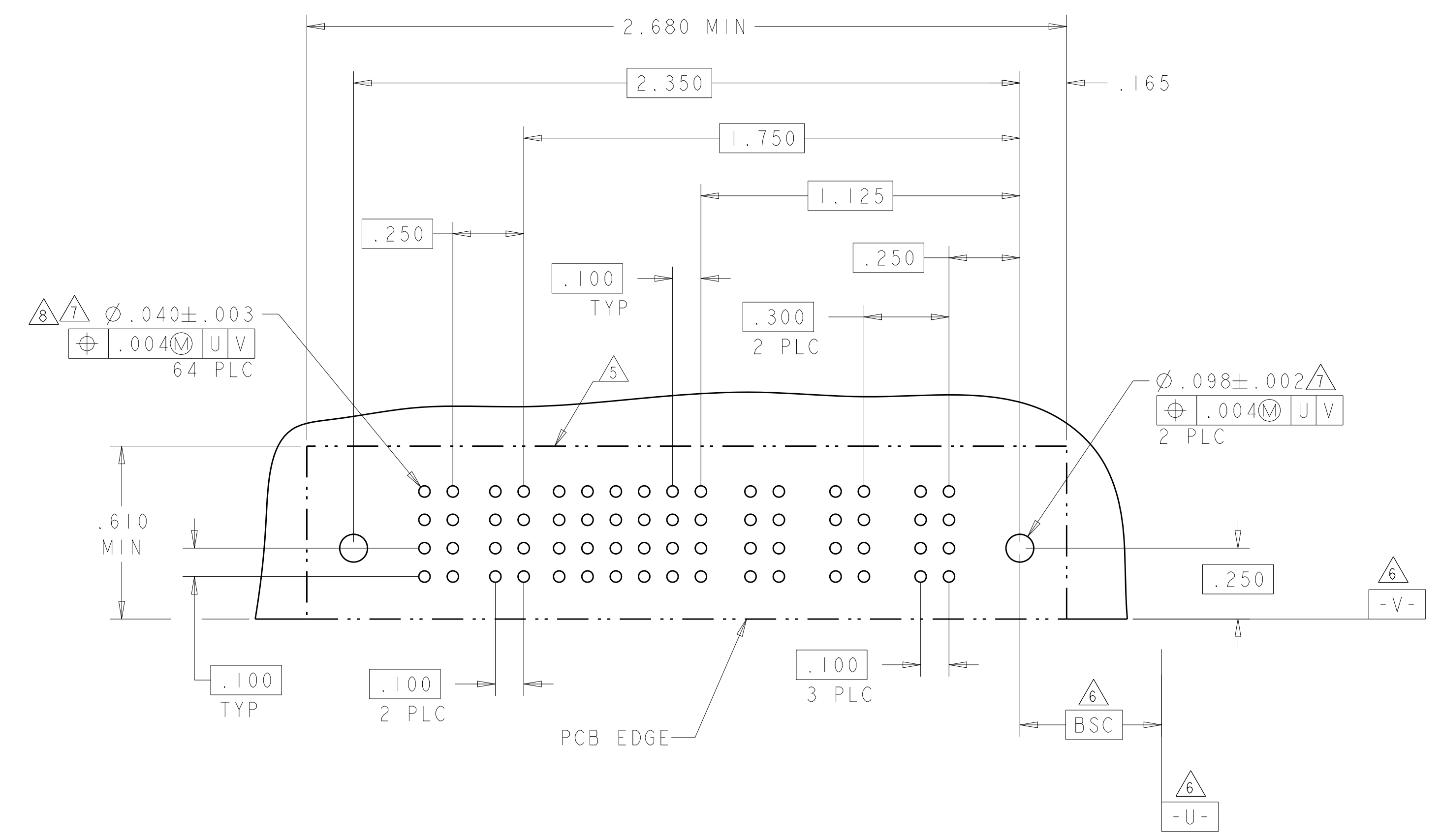
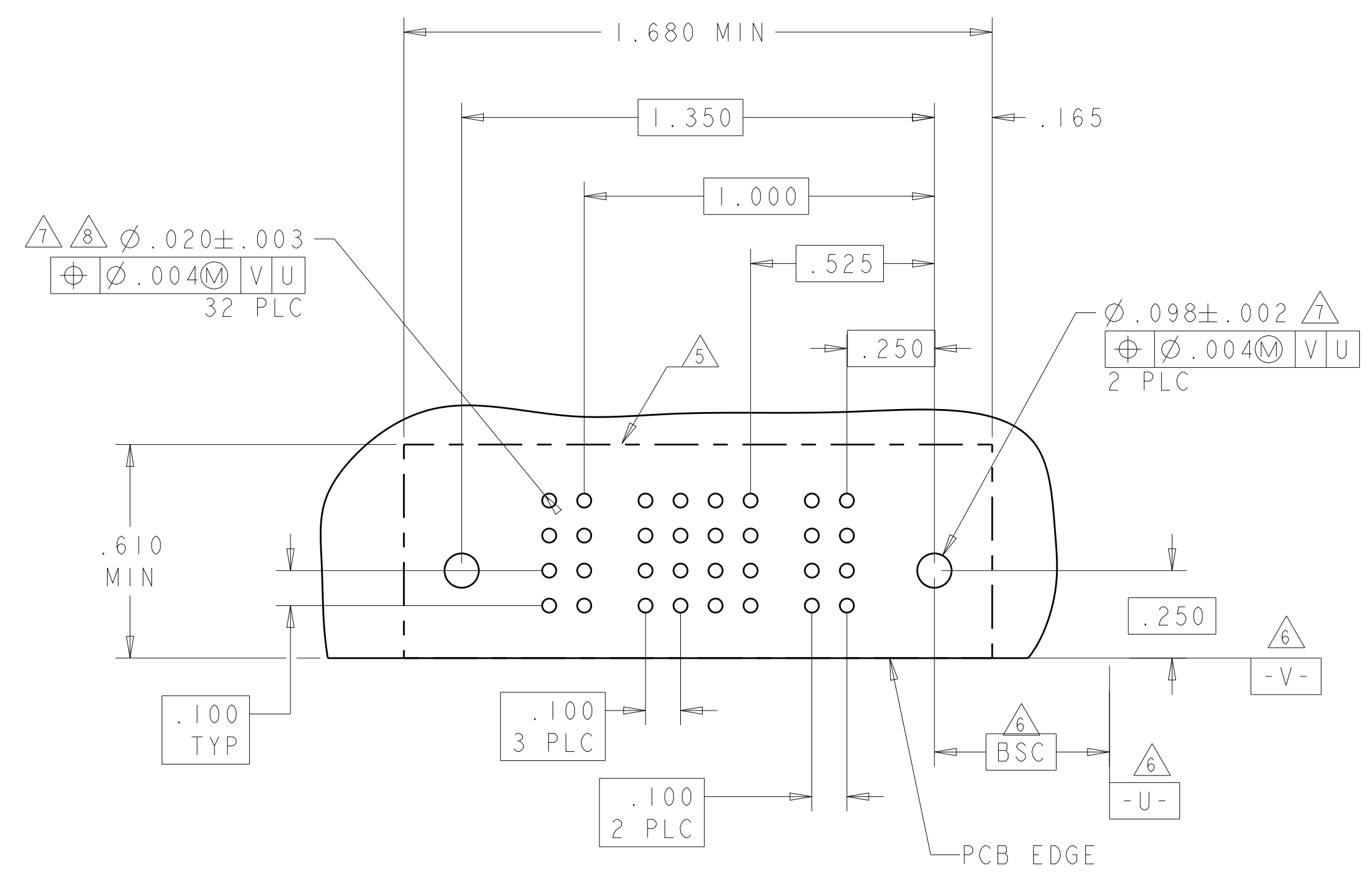

THIS DRAWING IS A CONTROLLED DOCUMENT.		OWN: R. GRZYBOWSKI / Z1FEB05	 TE Connectivity
DIMENSIONS: INCHES		CHK: M. PERCHERKE / Z1FEB05	
TOLERANCES UNLESS OTHERWISE SPECIFIED:		APVD: M. PERCHERKE	NAME: RIGHT ANGLE RECEPTACLE ASSEMBLY WITH GUIDES MULTI-BEAM XL
0 PLC ±. 1 PLC ±.01 2 PLC ±.01 3 PLC ±.005 4 PLC ±.0020 ANGLES ±.2°		PRODUCT SPEC: 108-1973	SIZE: A1
MATERIAL: -		APPLICATION SPEC: 114-13038	CAGE CODE: 6450170
FINISH: -		WEIGHT: -	RESTRICTED TO: -
		CUSTOMER DRAWING	SCALE: 4:1 SHEET 7 OF 13 REV: J5

LOC	DIST	REVISIONS			
P	LTN	DESCRIPTION	DATE	DMN	APVD
ES	00	SEE SHEET 1	-	-	-

PART NUMBER	ROWS	POWER		SIGNAL				POWER		HD
		P4	P3	4	3	2	1	P2	P1	
3-6450170-1	D	RM	RA	H	H	H	H	RA	RM	HD
	C			G	G	G	G			
	B			E	E	E	E			
	A			F	F	F	F			
2P + 16S + 2P										

PART NUMBER	ROWS	POWER			SIGNAL						POWER				HD
		P7	P6	P5	6	5	4	3	2	1	P4	P3	P2	P1	
1-6450170-8	D	RM	RM	RA	H	H	H	H	H	H	RM	RM	RM	RM	HD
	C				G	G	G	G	G						
	B				F	F	F	F	F						
	A				E	E	E	E	E						
4P + 24S + 3ACP															

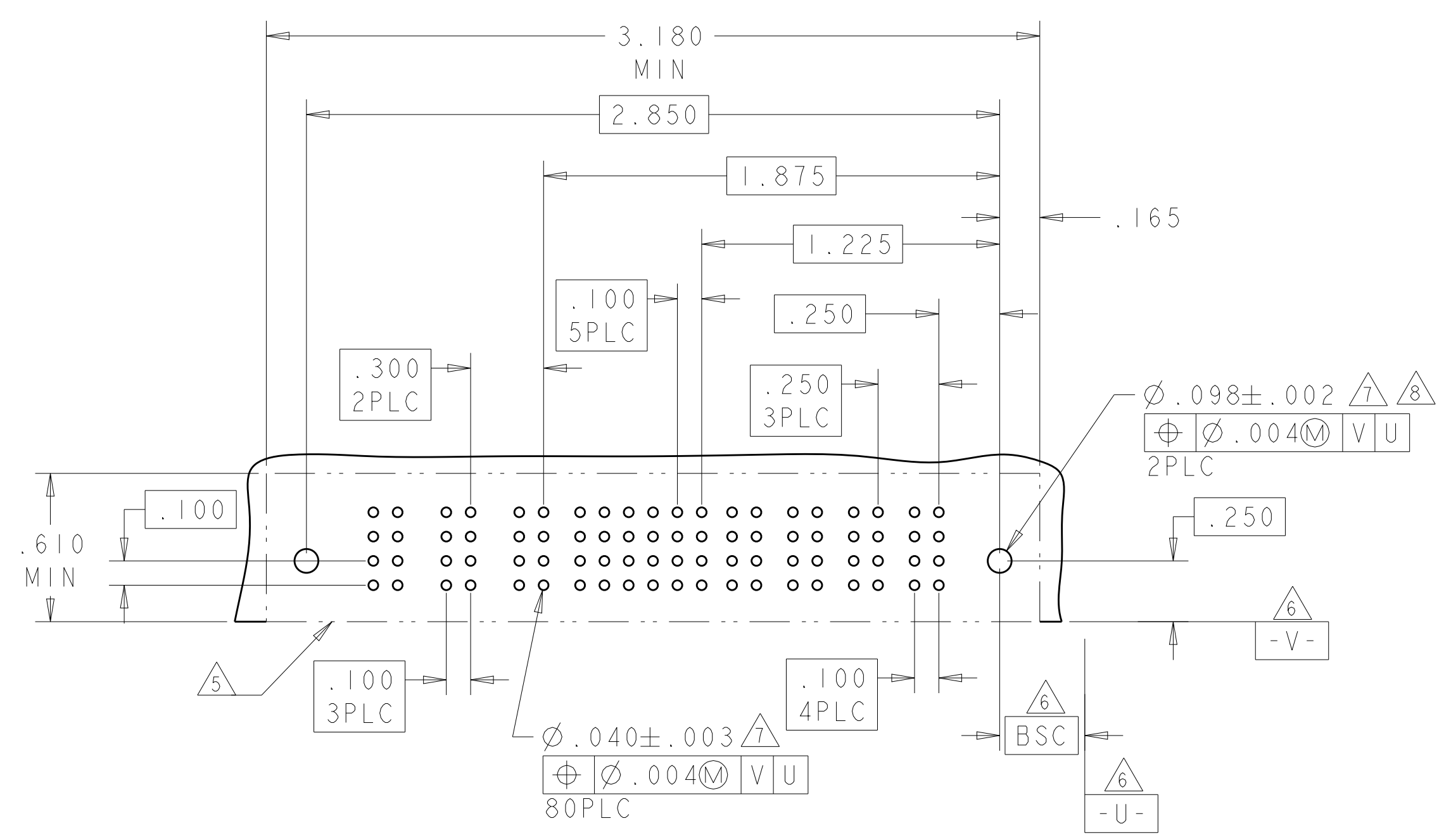
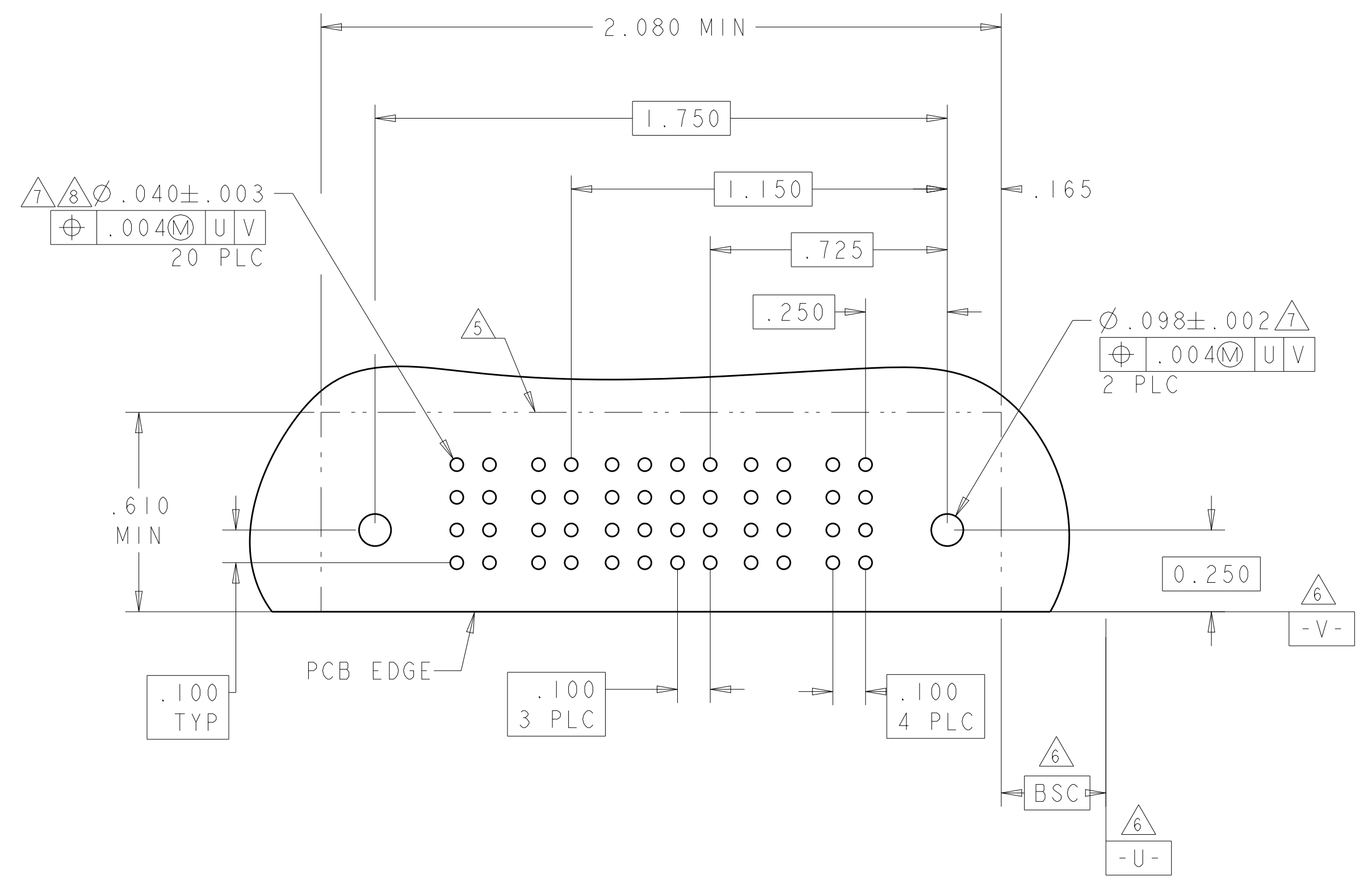

THIS DRAWING IS A CONTROLLED DOCUMENT.

DIMENSIONS: INCHES	TOLERANCES UNLESS OTHERWISE SPECIFIED: 0 PLC ± 1 PLC ±.01 2 PLC ±.01 3 PLC ±.005 4 PLC ±.002 ANGLES ±.2°	FINISH	FINISH
-----------------------	--	--------	--------

OWN: R. GRZYBOWSKI 21FEB05	CHK: M. PERCHERKE	APVD: M. PERCHERKE	NAME: R. GRZYBOWSKI
PRODUCT SPEC: 108-1973		APPLICATION SPEC: 114-13038	
WEIGHT: -		SIZE: A100779	
CUSTOMER DRAWING		SCALE: 4:1	

TE Connectivity
 RIGHT ANGLE RECEPTACLE ASSEMBLY WITH GUIDES MULTI-BEAM XL
 SHEET 8 OF 13 REV J5

LOC	DIST	REV	DATE	BY	APPV
ES	00				

REVISIONS					
NO.	DESCRIPTION	DATE	BY	APPV	
-	SEE SHEET 1	-	-	-	-

PART NUMBER	ROWS	POWER					SIGNAL			POWER	
		P7	P6	P5	P4	P3	3	2	1	P2	P1
3-6450170-4	D C B A	RM	RM	RM	RM	RM	H	H	H	RM	RM
							G	G	G		
							F	F	F		
							E	E	E		

2P + 12S + 5P

PART NUMBER	ROWS	POWER		SIGNAL		POWER	
		P4	P3	2	1	P2	P1
3-6450170-5	D C B A	RA	RA	H	H	RM	RM
				G	G		
				F	F		
				E	E		

2P + 8S + 2P

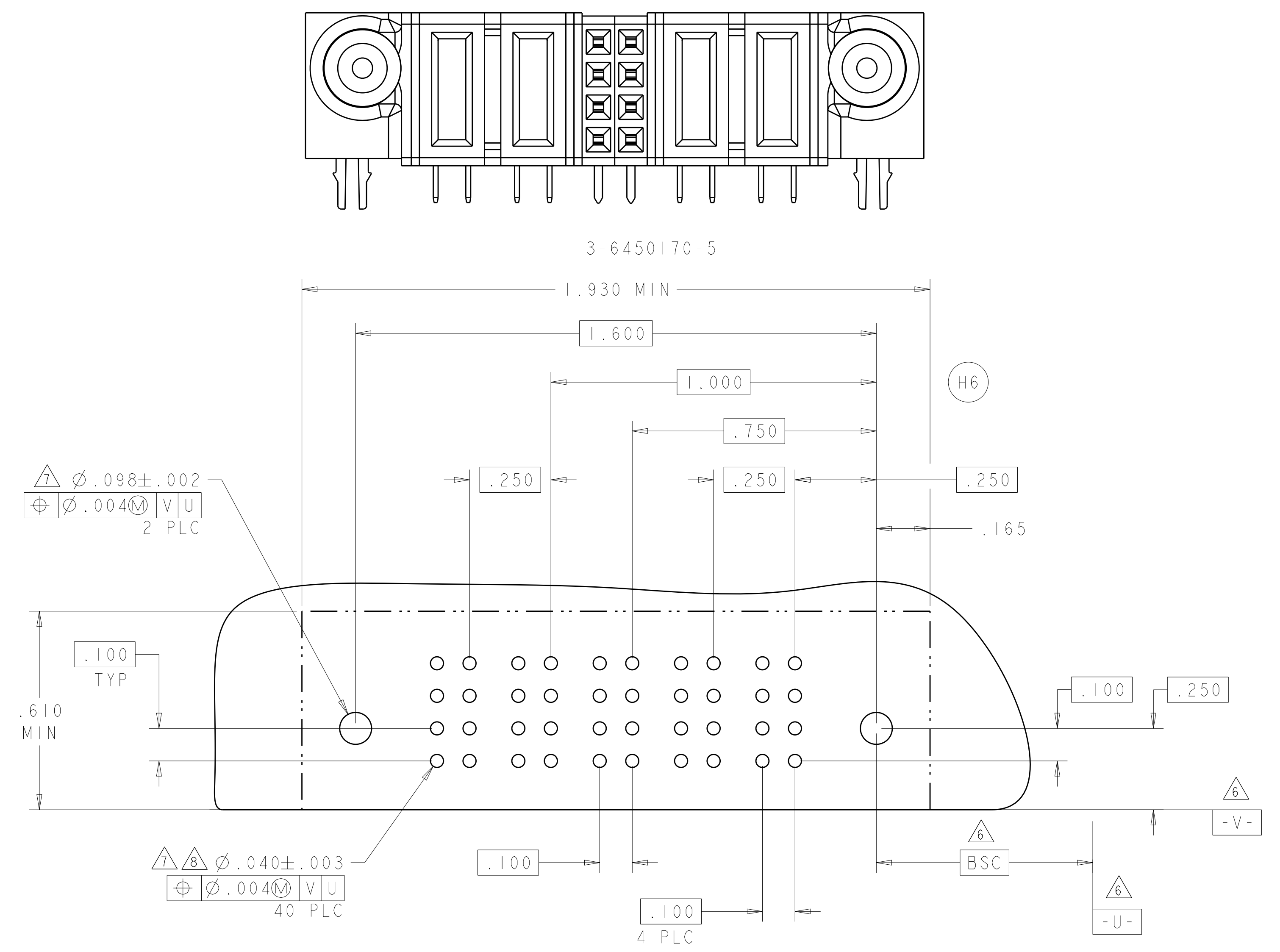
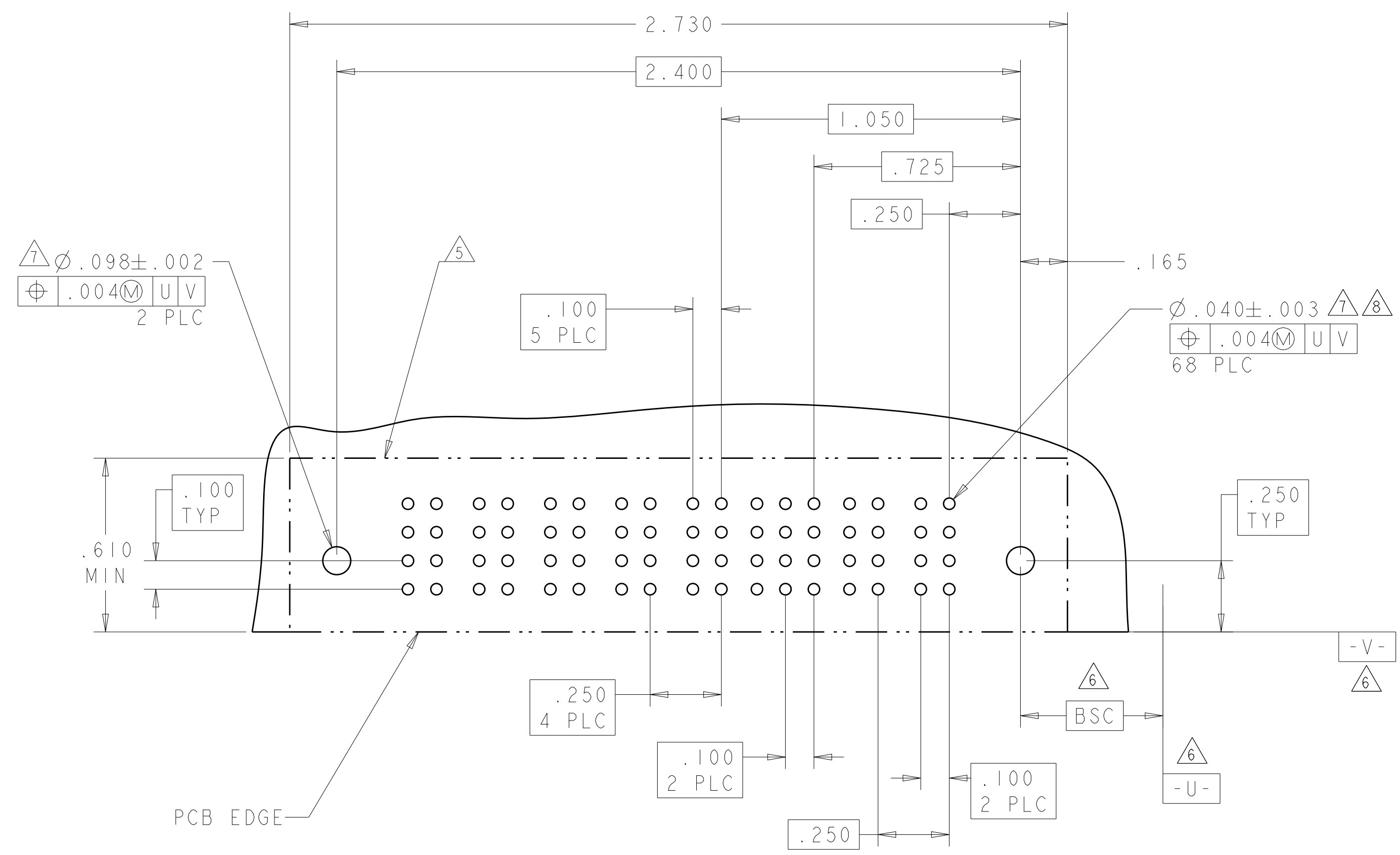

THIS DRAWING IS A CONTROLLED DOCUMENT.		DWN: R. GRZYBOWSKI CHK: M. PERCHERKE APVD: M. PERCHERKE	Z1FEB05 Z1FEB05	TE Connectivity
DIMENSIONS: INCHES	TOLERANCES UNLESS OTHERWISE SPECIFIED: 0 PLC ±. 1 PLC ±.01 2 PLC ±.01 3 PLC ±.005 4 PLC ±.002 ANGLES ±.020	NAME: RIGHT ANGLE RECEPTACLE ASSEMBLY WITH GUIDES MULTI-BEAM XL	PRODUCT SPEC: 108-1973 APPLICATION SPEC	
MATERIAL:	FINISH:	WEIGHT:	CUSTOMER DRAWING	SCALE: 4:1 SHEET 10 OF 13 REV J5

LOC		DIST		REVISIONS			
ES	00	P	LTN	DESCRIPTION	DATE	DMN	APVD
				SEE SHEET 1			

PART NUMBER	ROWS	POWER		SIGNAL				POWER		H7
		P4	P3	4	3	2	1	P2	PI	
3-6450170-6	D	RA	RA	H	H	H	H	RM	RM	H7
	C			G	G	G	G			
	B			E	E	E	E			
	A			F	F	F	F			

2P + 16S + 2P

PART NUMBER	ROWS	POWER		SIGNAL								POWER		H8
		P2	8	7	6	5	4	3	2	1	PI			
3-6450170-7	D C B A	RM	RM	H	H	H	H	H	H	H	H	H	RM	H8
				G	G	G	G	G	G	G	G			
				F	F	F	F	F	F	F	F			
				E	E	E	E	E	E	E	E			

IP + 32S + IP

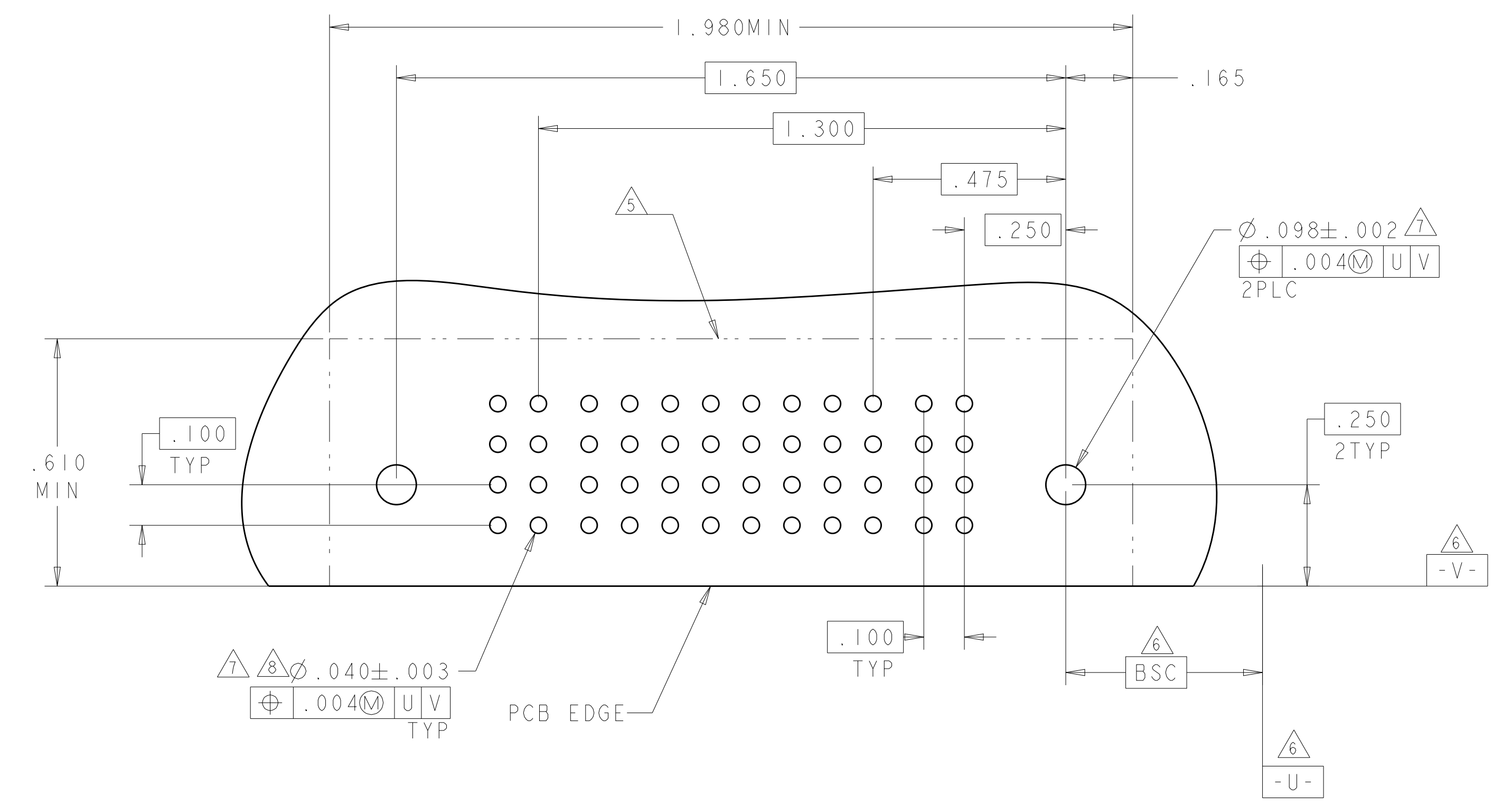
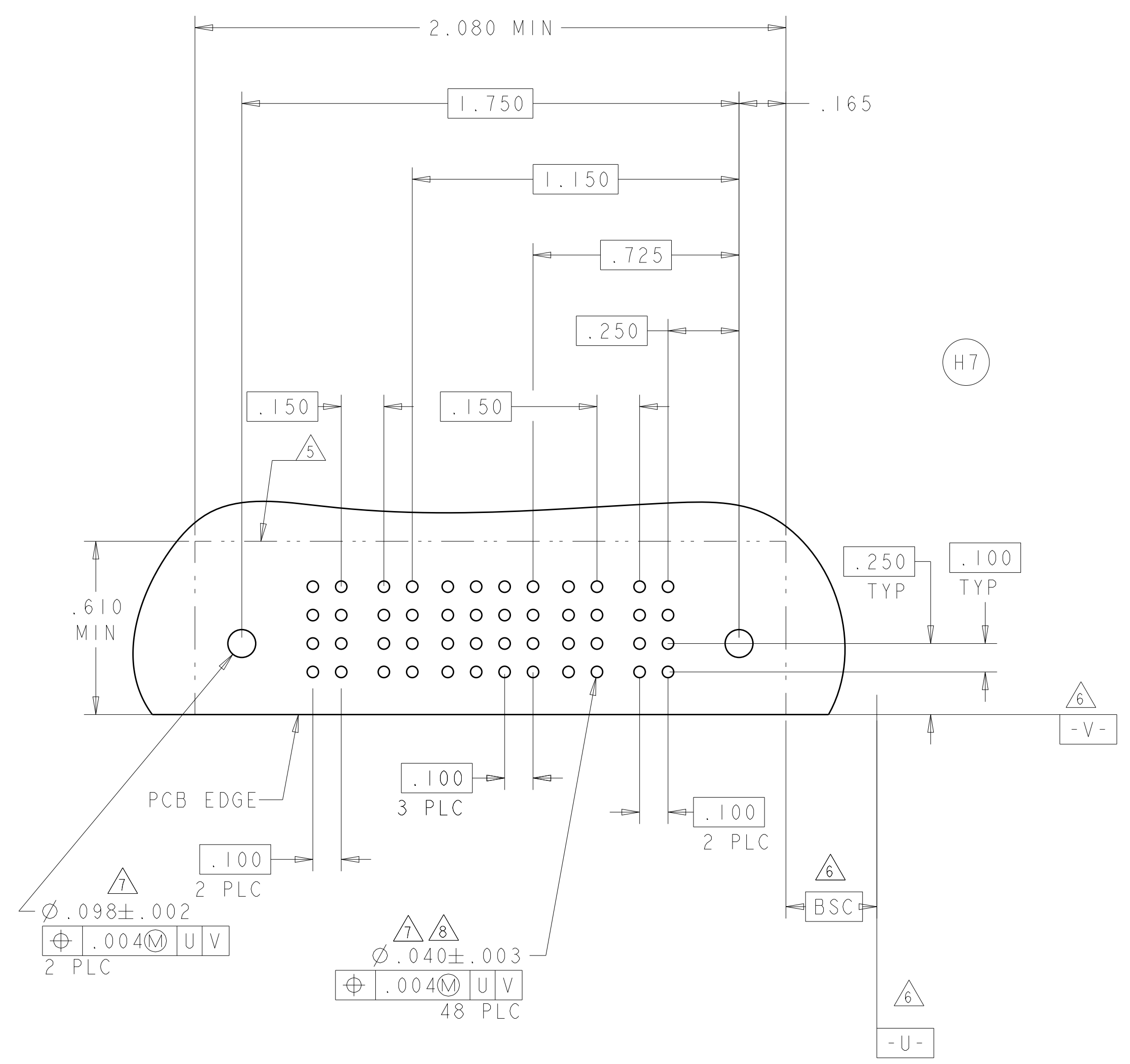

THIS DRAWING IS A CONTROLLED DOCUMENT.

DIMENSIONS: INCHES	TOLERANCES UNLESS OTHERWISE SPECIFIED: 0 PLC ±. 2 PLC ±.01 3 PLC ±.005 4 PLC ±.0020 ANGLES ±.7°	FINISH	FINISH
-----------------------	--	--------	--------

DMN: R. GRZYBOWSKI 21FEB05	CHK: M. PERCHERKE 21FEB05	APVD: M. PERCHERKE	NAME: RIGHT ANGLE RECEPTACLE ASSEMBLY WITH GUIDES MULTI-BEAM XL
PRODUCT SPEC: 108-1973	APPLICATION SPEC: 114-13038	WEIGHT: -	SIZE: A100779
CAGE CODE: -	DRAWING NO: C=6450170	SCALE: 4:1	SHEET 11 OF 13
CUSTOMER DRAWING	REV: J5		

STE TE Connectivity

LOC	DIST	REV	DATE	BY	APPV
ES	00				
REVISIONS					
DESCRIPTION					
SEE SHEET 1					

PART NUMBER	ROWS	SIGNAL										POWER		
		P2	10	9	8	7	6	5	4	3	2	1	PI	
3-6450170-8	D C B A	H	H	H	H	H	H	H	H	H	H	H	RM	
		G	G	G	G	G	G	G	G	G	G	G	RM	
		F	F	F	F	F	F	F	F	F	F	F	RM	
		E	E	E	E	E	E	E	E	E	E	E	RM	
IP + 40S + IP														

PART NUMBER	ROWS	POWER		SIGNAL		POWER		
		P5	P4	2	1	P3	P2	PI
3-6450170-9	D C B A	RM	RM	H	H	RA	RM	RM
				G	G			
				F	F			
				E	E			
3ACP + 8S + 2P								

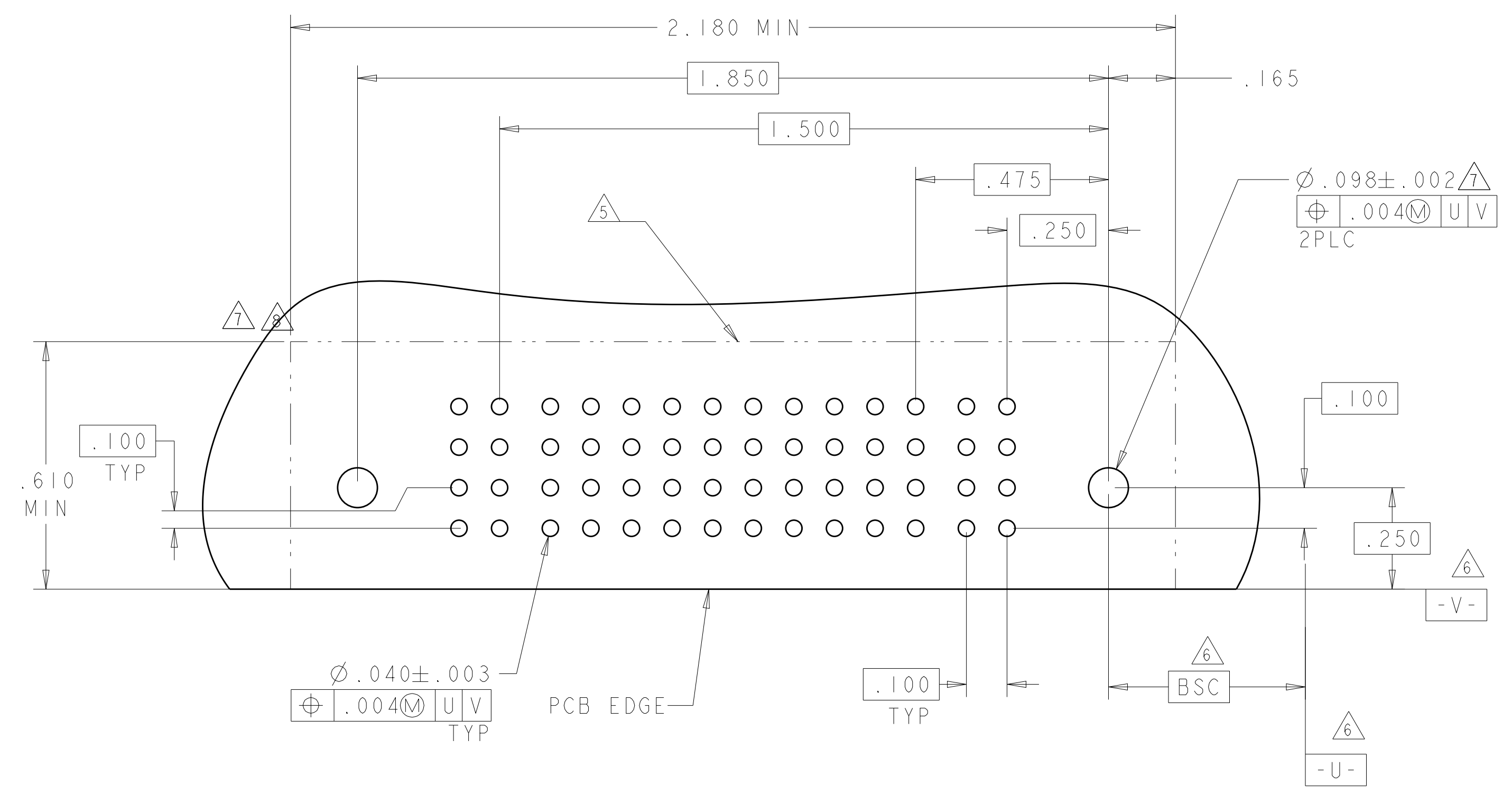

TE RECOMMENDED PCB LAYOUT

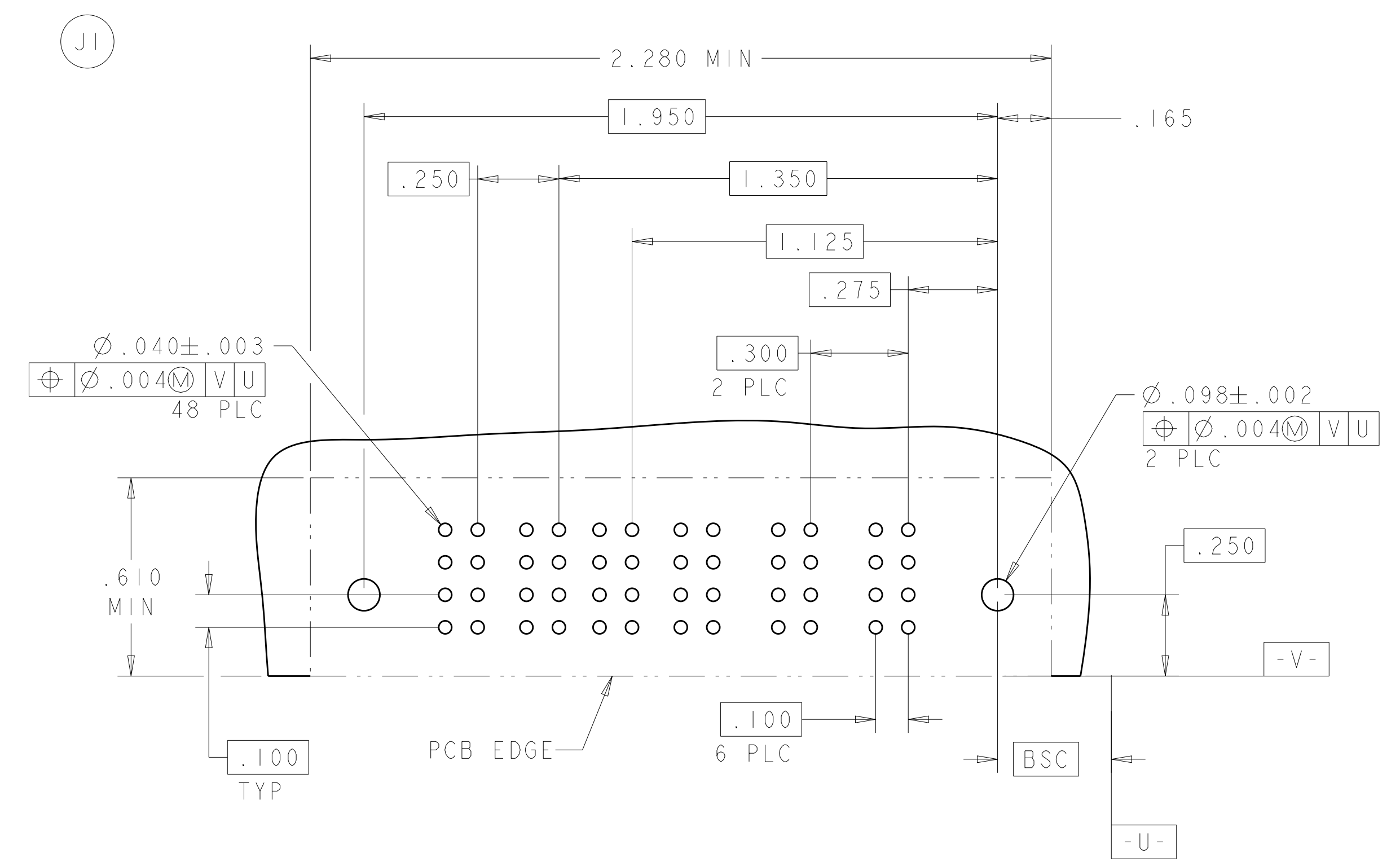

THIS DRAWING IS A CONTROLLED DOCUMENT.		DWN: R. GRZYBOWSKI 21FEB05 CHK: M. PERCHERKE 21FEB05 APVD: M. PERCHERKE NAME: RIGHT ANGLE RECEPTACLE ASSEMBLY WITH GUIDES MULTI-BEAM XL
DIMENSIONS: INCHES TOLERANCES UNLESS OTHERWISE SPECIFIED: 0 PLC ±. 1 PLC ±.01 2 PLC ±.01 3 PLC ±.005 4 PLC ±.0020 ANGLES ±.020	PRODUCT SPEC: 108-1973 APPLICATION SPEC: 114-13038 WEIGHT: - FINISH: -	SIZE: A1 CAGE CODE: 6450170 DRAWING NO: 100779 SCALE: 4:1 SHEET: 12 OF 13 REV: J5
MATERIAL: -		CUSTOMER DRAWING DATE: - DWN: - APPV: -

LOC	DIST	REVISIONS			
P	LTN	DESCRIPTION	DATE	DMN	APVD
ES	00	SEE SHEET 1			

PART NUMBER	ROWS	POWER				SIGNAL			POWER					
		P10	P9	P8	P7	3	2	1	P6	P5	P4	P3	P2	P1
4-6450170-0	D	RM	RM	RM	RM	H	H	H	RM	RM	RM	RM	RA	RA
	C					G	G	G						
	B					F	F	F						
	A					E	E	E						

6P + 12S + 4P

PART NUMBER	ROWS	POWER				SIGNAL						POWER							
		P8	P7	P6	P5	P4	P3	6	5	4	3	2	1	P2	P1				
4-6450170-1	D	RM	RM	RA	RA	RA	RA	RA	RA	RA	RA	RA	RA	RA					
	C														G	G	G	G	G
	B														F	F	F	F	F
	A														E	E	E	E	E

2P + 24S + 6P

NO CONTACTS LOADED

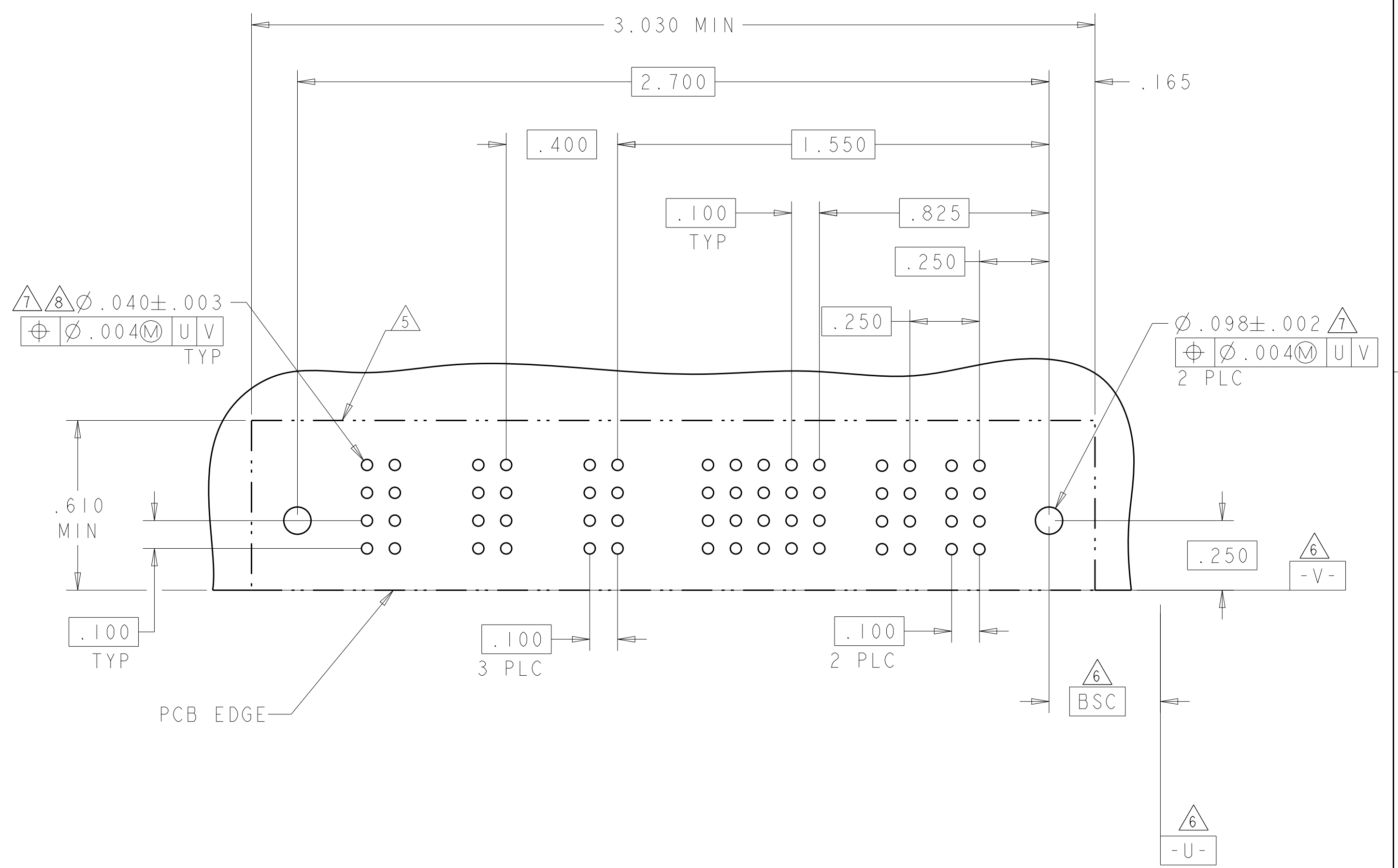
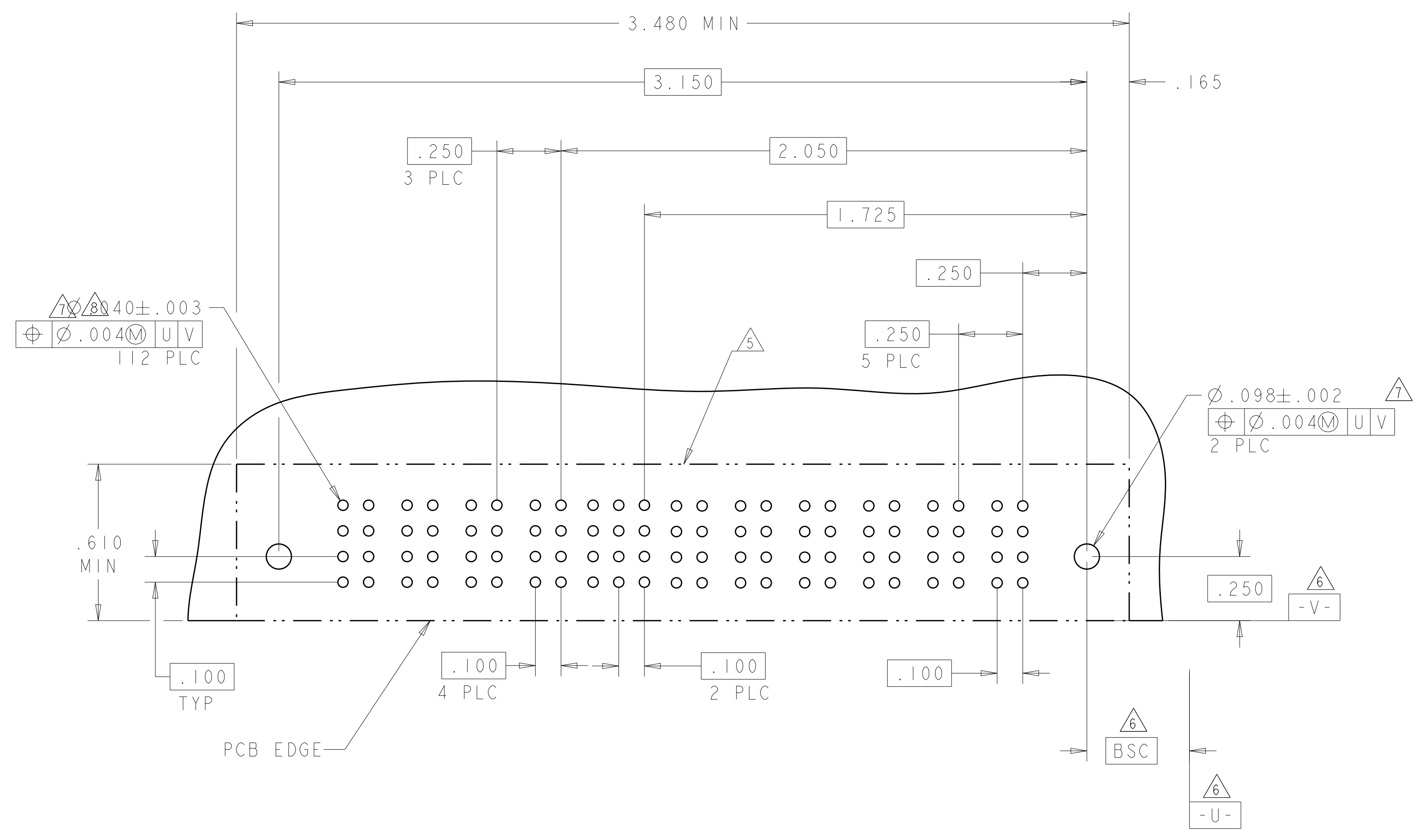

THIS DRAWING IS A CONTROLLED DOCUMENT.		DMN: R. GRZYBOWSKI 21FEB05	 TE Connectivity
DIMENSIONS: INCHES		CHK: M. PERCHERKE 21FEB05	
TOLERANCES UNLESS OTHERWISE SPECIFIED:		APVD: M. PERCHERKE	NAME: RIGHT ANGLE RECEPTACLE ASSEMBLY WITH GUIDES MULTI-BEAM XL
0 PLC ±.01	1 PLC ±.01	PRODUCT SPEC: 108-1973	SIZE: A100779
2 PLC ±.005	3 PLC ±.005	APPLICATION SPEC: 114-13038	CAGE CODE: C=6450170
4 PLC ±.0020	ANGLES ±.020	WEIGHT: -	RESTRICTED TO: -
MATERIAL: -		FINISH: -	SCALE: 4:1
CUSTOMER DRAWING		SHEET: 13 OF 13	REV: J5

Компания «Life Electronics» занимается поставками электронных компонентов импортного и отечественного производства от производителей и со складов крупных дистрибьюторов Европы, Америки и Азии.

С конца 2013 года компания активно расширяет линейку поставок компонентов по направлению коаксиальный кабель, кварцевые генераторы и конденсаторы (керамические, пленочные, электролитические), за счёт заключения дистрибьюторских договоров

Мы предлагаем:

- Конкуренеспособные цены и скидки постоянным клиентам.
- Специальные условия для постоянных клиентов.
- Подбор аналогов.
- Поставку компонентов в любых объемах, удовлетворяющих вашим потребностям.
- Приемлемые сроки поставки, возможна ускоренная поставка.
- Доставку товара в любую точку России и стран СНГ.
- Комплексную поставку.
- Работу по проектам и поставку образцов.
- Формирование склада под заказчика.
- Сертификаты соответствия на поставляемую продукцию (по желанию клиента).
- Тестирование поставляемой продукции.
- Поставку компонентов, требующих военную и космическую приемку.
- Входной контроль качества.
- Наличие сертификата ISO.

В составе нашей компании организован Конструкторский отдел, призванный помогать разработчикам, и инженерам.

Конструкторский отдел помогает осуществить:

- Регистрацию проекта у производителя компонентов.
- Техническую поддержку проекта.
- Защиту от снятия компонента с производства.
- Оценку стоимости проекта по компонентам.
- Изготовление тестовой платы монтаж и пусконаладочные работы.



Тел: +7 (812) 336 43 04 (многоканальный)

Email: org@lifeelectronics.ru