



Is Now Part of



ON Semiconductor®

To learn more about ON Semiconductor, please visit our website at
www.onsemi.com

Please note: As part of the Fairchild Semiconductor integration, some of the Fairchild orderable part numbers will need to change in order to meet ON Semiconductor's system requirements. Since the ON Semiconductor product management systems do not have the ability to manage part nomenclature that utilizes an underscore (_), the underscore (_) in the Fairchild part numbers will be changed to a dash (-). This document may contain device numbers with an underscore (_). Please check the ON Semiconductor website to verify the updated device numbers. The most current and up-to-date ordering information can be found at www.onsemi.com. Please email any questions regarding the system integration to Fairchild_questions@onsemi.com.

ON Semiconductor and the ON Semiconductor logo are trademarks of Semiconductor Components Industries, LLC dba ON Semiconductor or its subsidiaries in the United States and/or other countries. ON Semiconductor owns the rights to a number of patents, trademarks, copyrights, trade secrets, and other intellectual property. A listing of ON Semiconductor's product/patent coverage may be accessed at www.onsemi.com/site/pdf/Patent-Marking.pdf. ON Semiconductor reserves the right to make changes without further notice to any products herein. ON Semiconductor makes no warranty, representation or guarantee regarding the suitability of its products for any particular purpose, nor does ON Semiconductor assume any liability arising out of the application or use of any product or circuit, and specifically disclaims any and all liability, including without limitation special, consequential or incidental damages. Buyer is responsible for its products and applications using ON Semiconductor products, including compliance with all laws, regulations and safety requirements or standards, regardless of any support or applications information provided by ON Semiconductor. "Typical" parameters which may be provided in ON Semiconductor data sheets and/or specifications can and do vary in different applications and actual performance may vary over time. All operating parameters, including "Typicals" must be validated for each customer application by customer's technical experts. ON Semiconductor does not convey any license under its patent rights nor the rights of others. ON Semiconductor products are not designed, intended, or authorized for use as a critical component in life support systems or any FDA Class 3 medical devices or medical devices with a same or similar classification in a foreign jurisdiction or any devices intended for implantation in the human body. Should Buyer purchase or use ON Semiconductor products for any such unintended or unauthorized application, Buyer shall indemnify and hold ON Semiconductor and its officers, employees, subsidiaries, affiliates, and distributors harmless against all claims, costs, damages, and expenses, and reasonable attorney fees arising out of, directly or indirectly, any claim of personal injury or death associated with such unintended or unauthorized use, even if such claim alleges that ON Semiconductor was negligent regarding the design or manufacture of the part. ON Semiconductor is an Equal Opportunity/Affirmative Action Employer. This literature is subject to all applicable copyright laws and is not for resale in any manner.

FAN5640 — Dual High-Side Constant Current Source for High-Voltage Keypad LED Illumination

Features

- 20V Maximum Driver Input Level
- Dual Output
- 25mA Drive Capability per Channel
- Two Strings of 2-4 LEDs Each
- External Resistor Sets Maximum Current
- Fast Turn-On/Off Capability
- Low Bias Current
- SC70-6 Package
- Thermal Shutdown Protection

Applications

- Keypad Illumination
- Main Display and Sub-Display Illumination
- Cell Phones, Smart Phones
- Pocket PCs
- PDA, DSC, PMP, and MP3 Players

Description

The FAN5640 is designed to illuminate one or two strings of keypad LEDs with constant high-side current sources.

The device can drive up to four white LEDs in series at a maximum current of 25mA per channel. If the second channel is not needed, the channels can be tied together to boost output current up to 50mA.

An external resistor programs the maximum output current. Dimming can be accomplished by pulse width modulation of the enable pin or the input supply rail.

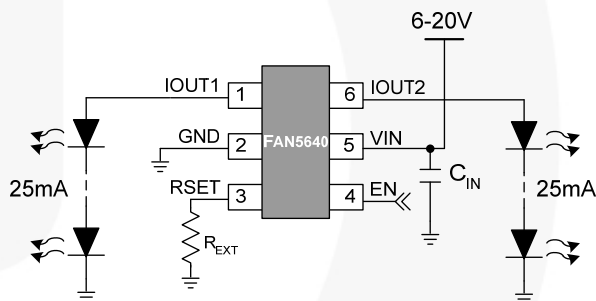

Figure 1. Typical Application

Ordering Information

Part Number	Operating Temperature Range	Package	Packing Method
FAN5640S7X	-40°C to 85°C	SC70-6 2x2.2mm	Tape and Reel

Block Diagram

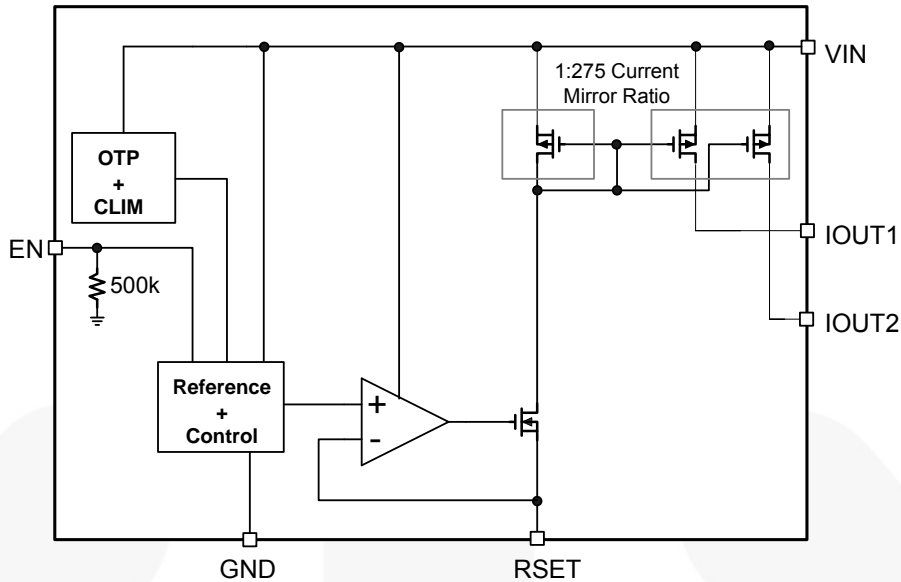

Figure 2. Block Diagram

Pin Configuration

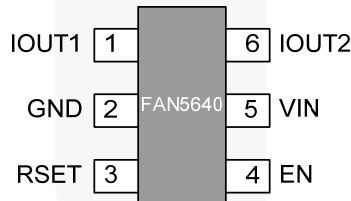

Figure 3. Pin Assignments

Pin Definitions

Pin #	Name	Description
1	IOUT1	Output Current 1. The programmed current I_{OUT} is sourced from this pin. If only one channel is used, IOUT1 and IOUT2 can be tied together to boost the output current. It can also be left floating or tied to pin 5.
2	GND	Ground
3	RSET	RSET. Connect a programming resistor R_{EXT} to this pin. This pin's output voltage is 0.475V when EN is HIGH. The current through the external resistor establishes the current I_{OUT} , where $I_{OUT} = 275 \cdot [0.475V / R_{EXT}]$.
4	EN	Enable. When HIGH, the IC applies the programmed current I_{OUT} to both IOUT1 and IOUT2. When LOW, IC enters Shutdown Mode. If pulsed, this pin modulates the output current. The minimum pulse width is determined by the speed of the turn-on circuitry. This pin contains an internal pull-down resistor of 500K Ω .
5	VIN	Input Supply. Apply 6 to 20V at this pin (see <i>Dropout Limitations under the Application Information section</i>).
6	IOUT2	Output Current 2. The programmed current I_{OUT} is sourced from this pin. If only one channel is used, IOUT1 and IOUT2 can be tied together to boost the output current. It can also be left floating or tied to pin 5.

Absolute Maximum Ratings

Stresses exceeding the absolute maximum ratings may damage the device. The device may not function or be operable above the recommended operating conditions and stressing the parts to these levels is not recommended. In addition, extended exposure to stresses above the recommended operating conditions may affect device reliability. The absolute maximum ratings are stress ratings only.

Symbol	Parameter	Min.	Max.	Unit
V_{EN}	Enable Voltage	-0.3	6.0	V
	V_{IN} , V_{IOUT1} , V_{IOUT2}	-0.3	22.0	V
I_{RSET}	Current Sourced by RSET		120	μ A
T_J	Junction Temperature	-40	150	$^{\circ}$ C
T_{STG}	Storage Temperature	-65	150	$^{\circ}$ C
T_L	Lead Soldering Temperature, 10 Seconds		260	$^{\circ}$ C
ESD	Electrostatic Discharge Protection Level	Human Body Model	2	kV
		Charged Device Model	2	

Recommended Operating Conditions

The Recommended Operating Conditions table defines the conditions for actual device operation. Recommended operating conditions are specified to ensure optimal performance to the datasheet specifications. Fairchild does not recommend exceeding them or designing to absolute maximum ratings.

Symbol	Parameter	Min.	Typ.	Max.	Unit
V_{IN}	Supply Voltage	6		20	V
V_{EN}	Enable Voltage			5.5	V
I_{OUT1} , I_{OUT2}	Output Current Range Through Each String	2.5		25.0	mA
T_A	Operating Ambient Temperature Range ⁽¹⁾	-40		+85	$^{\circ}$ C
T_J	Operating Junction Temperature Range ⁽¹⁾	-40		+125	$^{\circ}$ C

Thermal Properties

Symbol	Parameter	Min.	Typ.	Max.	Unit
Θ_{JA}	Junction to Ambient Thermal Resistance ⁽¹⁾		300		$^{\circ}$ C/W

Note:

1. Junction-to-Ambient thermal resistance is a function of application and board layout. This data is measured with four-layer, 1s2p boards in accordance with JESD51- JEDEC standard. Special attention must be paid not to exceed the maximum junction temperature.

Electrical Characteristics

$V_{IN} = 6V$ to $20V$, $T_A = -40^{\circ}C$ to $+85^{\circ}C$, unless otherwise noted. Typical values are at $T_A = 25^{\circ}C$, $V_{IN} = 14V$, $I_{LED} = 15mA$.

Symbol	Parameter	Condition	Min.	Typ.	Max.	Unit
Power Supplies						
V_{IN}	Input Voltage Range		6		20	V
I_Q	Quiescent Current	Measured at GND pin, $V_{IN} = 20V$		48	65	μA
		Measured at GND pin, $V_{IN} = 6V$		44	55	
I_{SD}	Shutdown Supply Current	$V_{IN} = 20V$, EN = GND		8	13	μA
		$V_{IN} = 6V$, EN = GND		5	8	
V_{EN}	Enable High-Level Input Voltage		1.2			V
	Enable Low-Level Input Voltage				0.4	
I_{EN}	Enable Input Current	EN = 5V		9	15	μA
		EN=GND		0.1	1.0	
Regulation						
I_{LIM1}	Channel 1 Current Limit ⁽²⁾		30			mA
I_{LIM2}	Channel 2 Current Limit ⁽²⁾		30			mA
ΔI_{OUT}	Output Current Accuracy	$2.5mA < I_{OUT} \leq 5mA$ ⁽³⁾	-15		+15	%
		$5mA < I_{OUT} \leq 25mA$ ⁽³⁾	-10		+10	
I_{MATCH}	Channel-to-Channel Current Matching ⁽⁴⁾		-3		+3	%
V_{DO}	Output Dropout Voltage	$V_{IN} - V_{OUT}$ at 90% I_{OUT} Programmed $I_{OUT} = 25mA$		1.80	2.50	V
		$V_{IN} - V_{OUT}$ at 90% I_{OUT} Programmed $I_{OUT} = 2.5mA$		0.43	0.60	
V_{REF}	Reference Voltage			475		mV
I_{MIRROR}	Current Mirror Ratio	I_{OUT} / I_{RSET}		275		
$\Delta I_{OUT} / \Delta V_{IN}$	Power Supply Current Dependency	$V_{OUT} = V_{IN} - 2V$ ⁽⁵⁾		0.5	2.0	%/V
T_{ON}	Turn-On Time	$V_{IN} = 14V$, $I_{OUT} = 12.5mA$ ⁽⁶⁾		5	8	μs
TSD	Thermal Shutdown Protection	Rising Temperature		150		$^{\circ}C$
		Hysteresis		20		

Notes:

- If only one channel is needed, I_{OUT1} can be tied to I_{OUT2} to boost maximum current to 50mA.
- R_{EXT} resistor tolerance adds to the specification limit of the pin RSET to determine overall current accuracy.
- Matching defined as $[(I_{OUT1} - I_{OUT2}) / (I_{OUT1} + I_{OUT2})] \times 100$.
- V_{OUT} is the total voltage drop across the LED string.
- Measured from EN crossing 1.8V to output current reaching 90% of target I_{OUT} .

Typical Characteristics

Unless otherwise noted, $C_{IN} = 4.7\mu\text{F}$, $V_{EN} = 1.8\text{V}$, $T_A = 25^\circ\text{C}$, white LED with $V_F = 3.3\text{V}$ at $I_{OUT} = 10\text{mA}$.

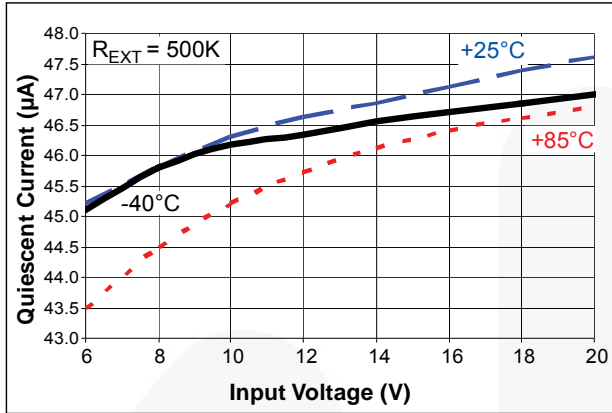

Figure 4. Quiescent Current vs. Input Voltage

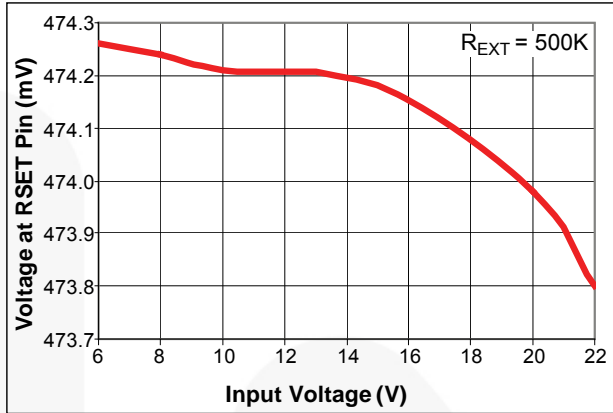

Figure 5. RSET Voltage vs. Input Voltage

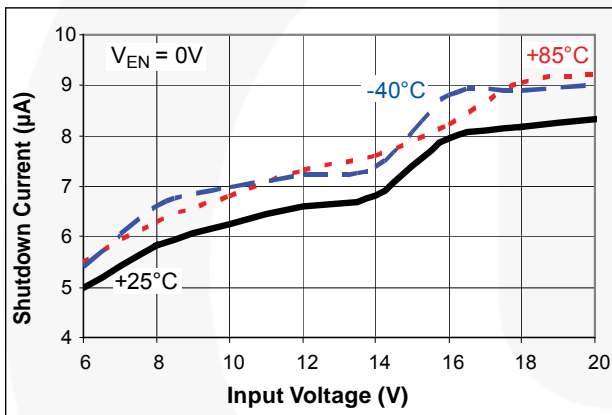

Figure 6. Shutdown Current vs. Input Voltage

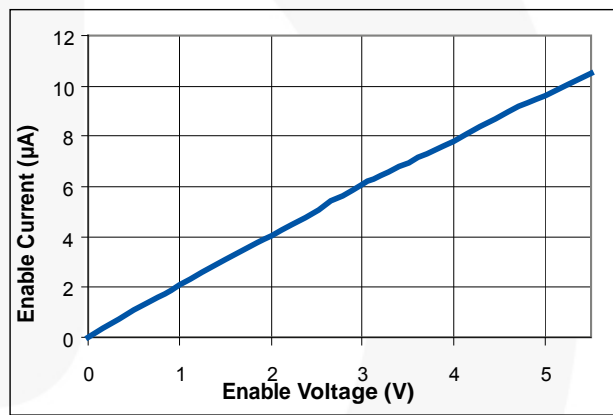

Figure 7. Enable Input Current vs. Enable Voltage

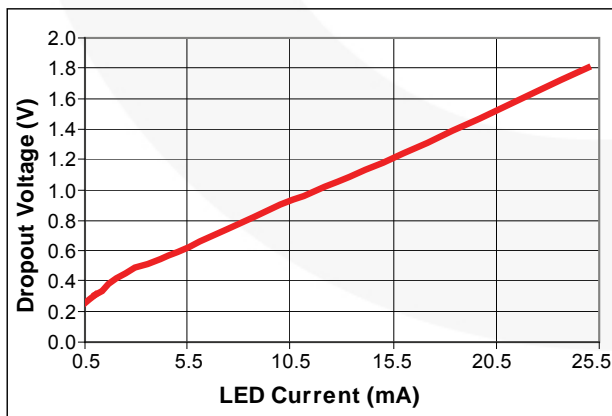

Figure 8. Dropout Voltage vs. LED Current

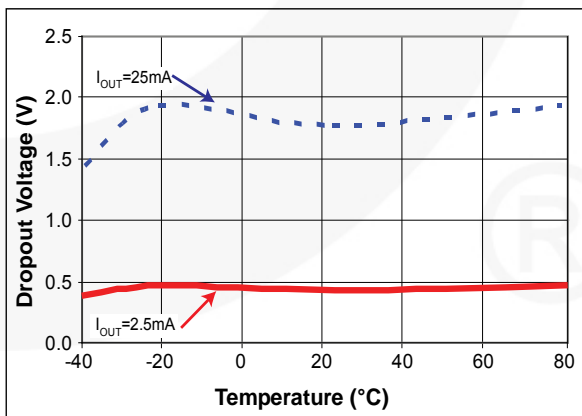

Figure 9. Dropout Voltage vs. Temperature

Typical Characteristics (Continued)

Unless otherwise noted, $C_{IN} = 4.7\mu\text{F}$, $V_{EN} = 1.8\text{V}$, $T_A = 25^\circ\text{C}$, white LED with $V_F = 3.3\text{V}$ at $I_{OUT} = 10\text{mA}$.

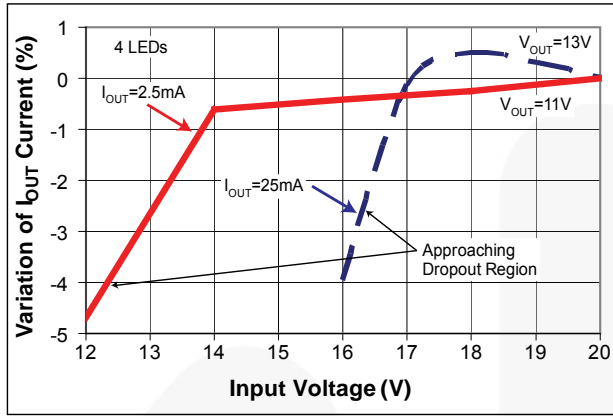

Figure 10. Line Regulation

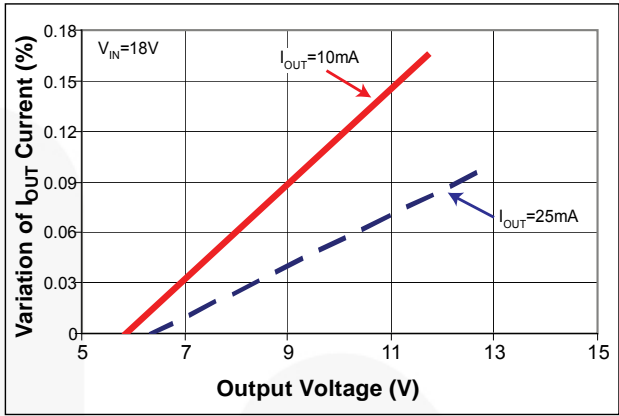

Figure 11. Variation of I_{OUT} Current vs. Output Voltage

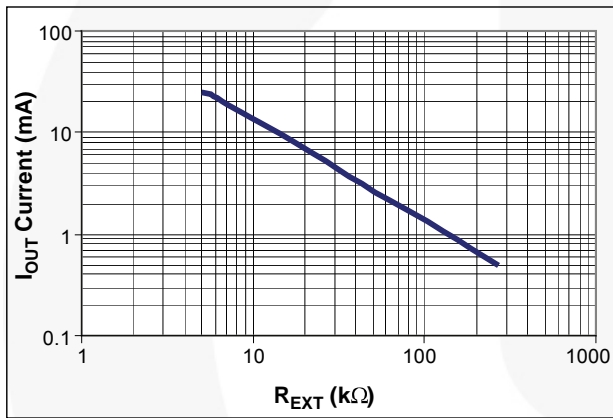

Figure 12. I_{OUT} Current vs. R_{EXT} Voltage

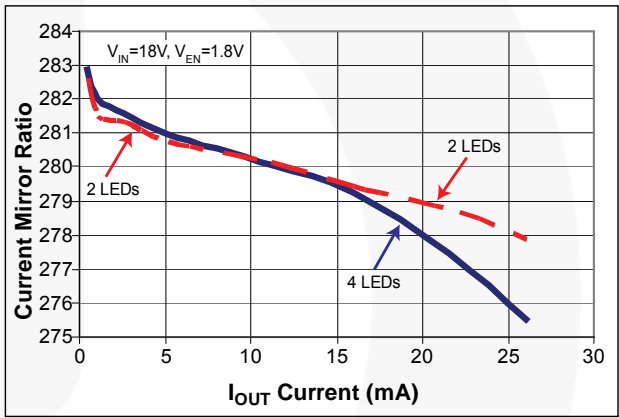

Figure 13. Current Mirror Ratio vs. LED Current

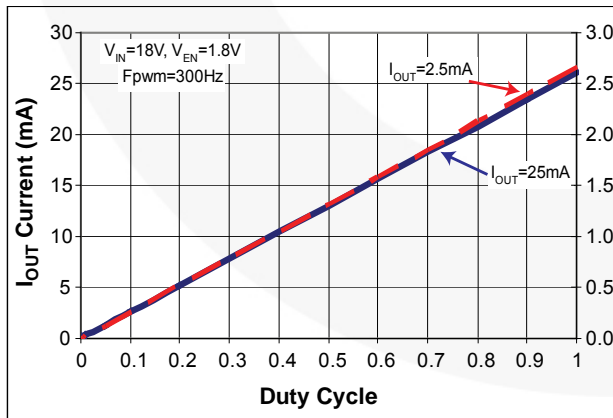

Figure 14. PWM Dimming on EN Pin

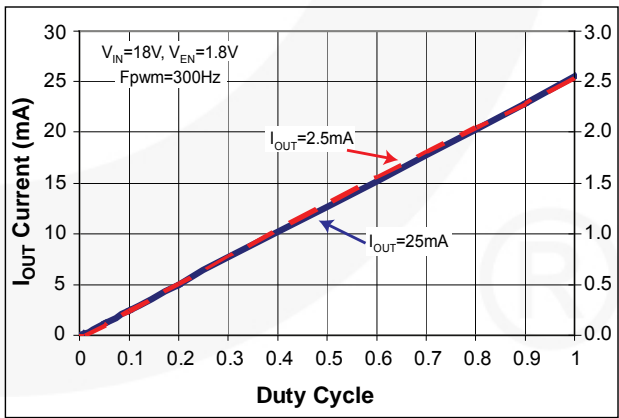

Figure 15. PWM Dimming on VIN Pin

Typical Characteristics (Continued)

Unless otherwise noted, $C_{IN} = 4.7\mu\text{F}$, $V_{EN} = 1.8\text{V}$, $T_A = 25^\circ\text{C}$, white LED with $V_F = 3.3\text{V}$ at $I_{OUT} = 10\text{mA}$.

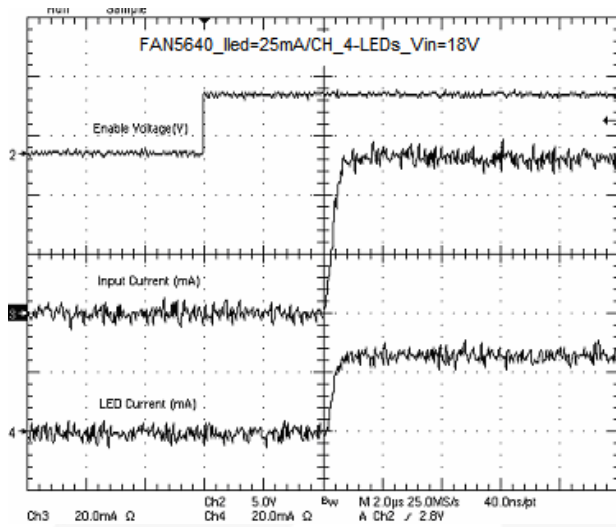

Figure 16. Turn-On at Full Load

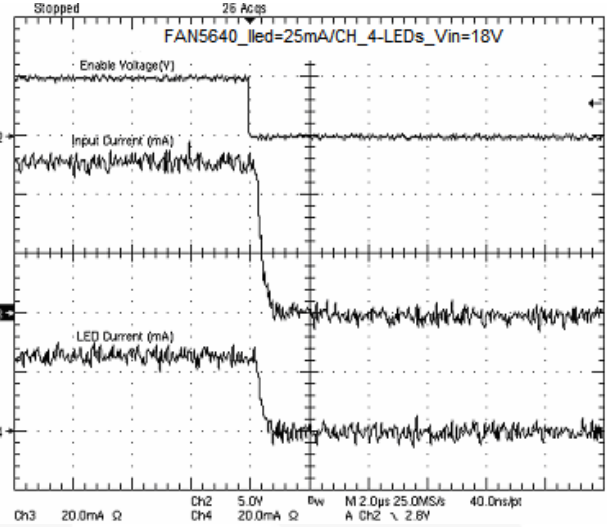

Figure 17. Turn-Off at Full Load

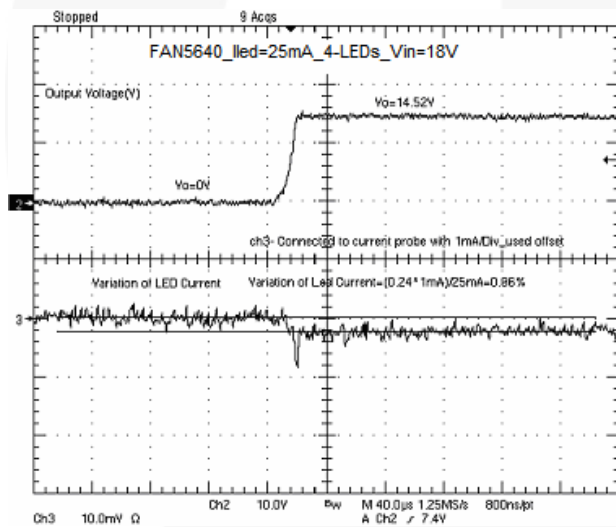

Figure 18. Load Transient Response (V_{OUT} Low to High)

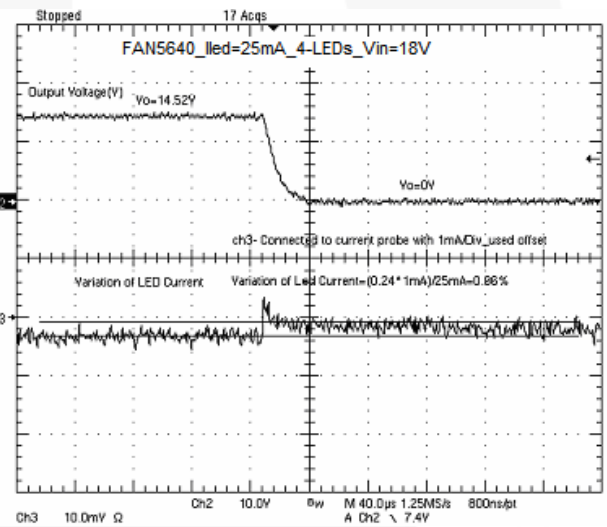

Figure 19. Load Transient Response (V_{OUT} High to Low)

PWM Dimming

PWM dimming can be implemented by toggling the enable (EN) pin (pin 4). The recommended PWM frequency range is 100Hz to 3kHz. For example, if the rise time is 2.2μs, the actual duty cycle applied internally to the output MOSFETs is slightly less than the duty cycle of the signal applied on the enable pin. This leads to a slight non-linearity in the measured LED current. That error is:

$$\frac{\Delta I_{OUT}}{I_{OUT_SET}} = -\frac{(2.2\mu \times f_{PWM})}{D_{PWM}} \times 100\% \quad \text{EQ. 4}$$

For example, at a PWM frequency of 3kHz, with an applied duty cycle of 10%, the typical error is:

$$\frac{\Delta I_{OUT}}{I_{OUT_SET}} = -\frac{(2.2\mu \times 3k)}{0.1} \times 100 = -6.6\% \quad \text{EQ. 5}$$

So, if R_{SET} is 5.225kΩ, the theoretically expected LED current, with a PWM duty cycle of 10%, is 2.5mA. However, the actual (measured) LED current is less by 6.6%. It is (1-0.066) multiplied by 2.5mA, which is 2.335mA. In this way, the actual LED current for any PWM duty cycle and frequency can be estimated.

Input Rail Dimming

The LEDs can also be dimmed by modulating the input supply rail. See *Figure 15, PWM Dimming By VIN Pin, under Typical Characteristics*. A maximum frequency of 1KHz is recommended.

Power Dissipation

At an ambient temperature (T_A), the power dissipation (P_D) and the junction temperature (T_J) are related to each other as described in the following equation:

$$T_J = T_A + P_D \times \Theta_{JA} \quad \text{EQ. 6}$$

where:

$$P_D = (V_{IN} - V_O) \times I_{OUT_Total} + V_{IN} \times I_Q + \frac{V_{RSET}}{R_{EXT}} \times (V_{IN} - V_{RSET})$$

and

$$I_{OUT_Total} = I_{OUT1} + I_{OUT2}$$

The quiescent current (I_Q) can be found in the Electrical Characteristics section. The junction-to-ambient thermal resistance (Θ_{JA}) puts a limit on V_{O_MAX}, I_{OUT_MAX}, and the maximum dropout (V_{IN-V_O})_{MAX}. This affects the number of LEDs used, the current used to drive them, and so on. Ensure that thermal shutdown does not occur. The formula that correlates all these variables is:

$$(V_{IN} - V_O)_{MAX} = \frac{T_{J_MAX} - T_{A_MAX}}{\Theta_{JA} \times I_{OUT_Total}} \quad \text{EQ. 7}$$

This should be solved for T_{J_MAX} and the result verified as less than the over-temperature shutdown threshold of 150°C (typical). An additional 25°C margin is recommended to account for tolerances on the shutdown threshold; T_{J_MAX} should not exceed 125°C. The Θ_{JA} is dependent on the surrounding PCB layout and can be around 300°C/W for an SC-70 package. This can be improved by providing a heat sink of surrounding copper ground on the PCB. The addition of backside copper with vias, stiffeners, and other enhancements can reduce this value. The heat contributed by the dissipation of other devices located nearby must be included in design considerations. Once the limiting parameters in these two relationships have been determined, the design can be modified to ensure that the device remains within specified operating conditions. If overload conditions are not considered, it is possible for the device to enter a thermal cycling loop, in which the circuit enters a shutdown condition, cools, re-enables, and again overheats and shuts down repeatedly due to an unmanaged fault condition.

LED Selection

The FAN5640 is designed to drive 2-4 LEDs or a higher number of monochrome LEDs. The maximum number of LEDs per channel can be calculated as a function of V_{IN} and the sum of the forward voltage of each LED at the maximum specified current. The minimum number of LEDs driven by FAN5640 is the result of calculating the maximum power dissipated by the IC in the given operating conditions. The forward voltage of LEDs depends upon type of LEDs and the manufacturer. In terms of maximum number of LEDs and LED current, refer to the Dropout Voltage vs. LED Current graph in the Typical Characteristics (see *Figure 8*).

Manufacturer	Part	Website
HARVATEK	HT-T169TW	www.harvatek.com
NICHIA	NSSW1087	www.nichia.com

Physical Dimensions

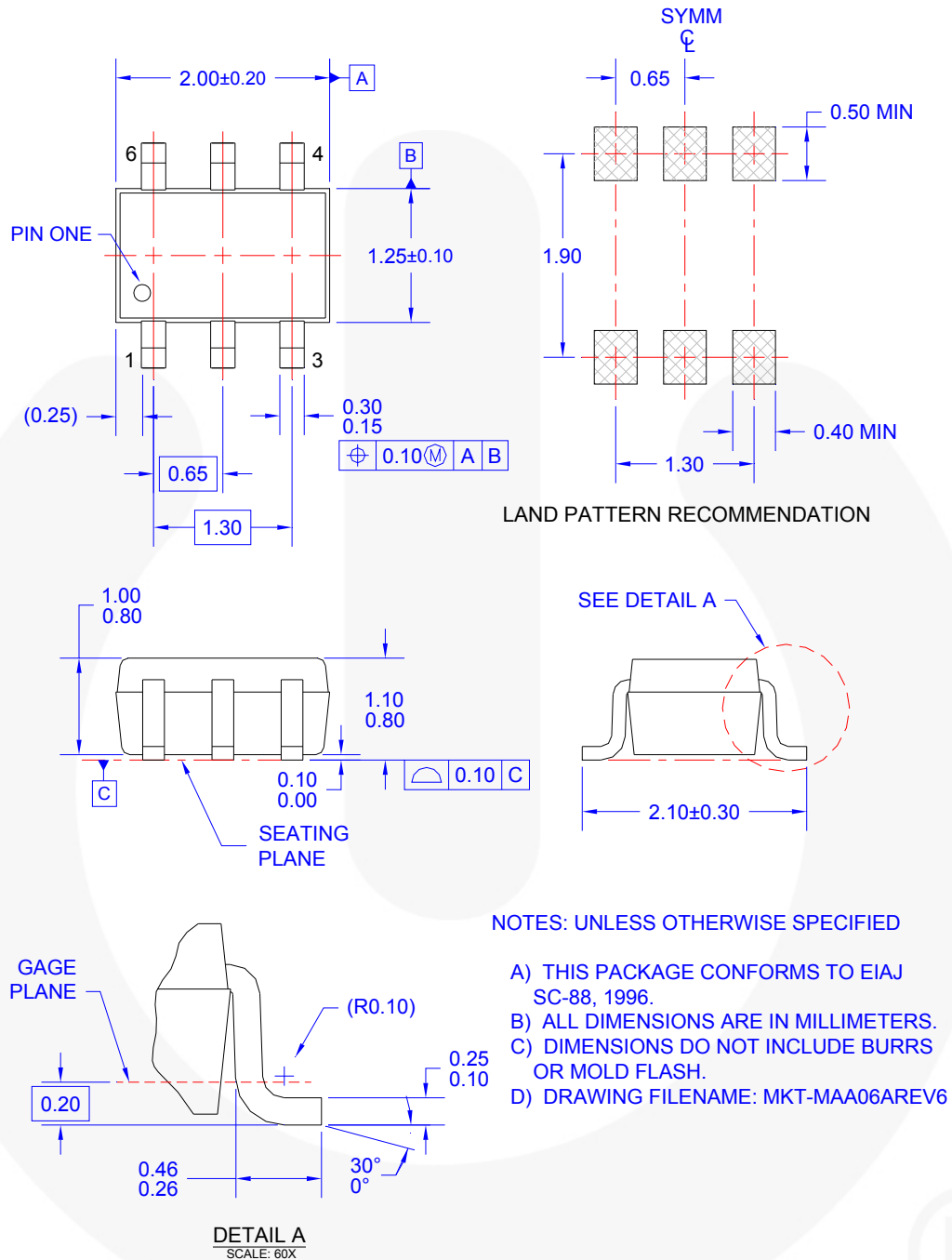

Figure 21. 6-Lead SC-70 Package Dimensions





Package drawings are provided as a service to customers considering Fairchild components. Drawings may change in any manner without notice. Please note the revision and/or date on the drawing and contact a Fairchild Semiconductor representative to verify or obtain the most recent revision. Package specifications do not expand the terms of Fairchild's worldwide terms and conditions, specifically the warranty therein, which covers Fairchild products.

Always visit Fairchild Semiconductor's online packaging area for the most recent package drawings:
<http://www.fairchildsemi.com/packaging/>.



TRADEMARKS

The following includes registered and unregistered trademarks and service marks, owned by Fairchild Semiconductor and/or its global subsidiaries, and is not intended to be an exhaustive list of all such trademarks.

- | | | | |
|---|--|---|---|
| 2Cool™ | F-PFS™ | PowerTrench® | The Power Franchise® |
| AccuPower™ | FRFET® | PowerXS™ | the power franchise |
| AX-CAP™* | Global Power Resource™ | Programmable Active Droop™ | TinyBoost™ |
| BitSiC™ | GreenBridge™ | QFET® | TinyBuck™ |
| Build it Now™ | Green FPS™ | QS™ | TinyCalc™ |
| CorePLUS™ | Green FPS™ e-Series™ | Quiet Series™ | TinyLogic® |
| CorePOWER™ | Gmax™ | RapidConfigure™ | TINYOPTO™ |
| CROSSVOLT™ | GTO™ |  | TinyPower™ |
| CTL™ | IntelliMAX™ | Saving our world, 1mW/WkW at a time™ | TinyPWM™ |
| Current Transfer Logic™ | ISOPLANAR™ | SignalWise™ | TinyWire™ |
| DEUXPEED® | Making Small Speakers Sound Louder and Better™ | SmartMax™ | TranSiC™ |
| Dual Cool™ | MegaBuck™ | SMART START™ | Solutions for Your Success™ |
| EcoSPARK® | MICROCOUPLER™ | SPM® | TRUECURRENT®* |
| EfficientMax™ | MicroFET™ | STEALTH™ | µSerDes™ |
| ESBC™ | MicroPak™ | SuperFET® |  |
|  | MicroPak2™ | SuperSOT™-3 | UHC® |
| Fairchild® | MillerDrive™ | SuperSOT™-6 | Ultra FRFET™ |
| Fairchild Semiconductor® | MotionMax™ | SuperSOT™-8 | UniFET™ |
| FACT Quiet Series™ | Motion-SPM™ | SupreMOS® | VCM™ |
| FACT® | mWSaver™ | SyncFET™ | VisualMax™ |
| FACT® | OptoHit™ | Sync-Lock™ | VoltagePlus™ |
| FastvCore™ | OPTOLOGIC® |  | XS™ |
| FETBench™ | OPTOPLANAR® | | |
| FlashWriter®* | | | |
| FPS™ | | | |

* Trademarks of System General Corporation, used under license by Fairchild Semiconductor.

DISCLAIMER

FAIRCHILD SEMICONDUCTOR RESERVES THE RIGHT TO MAKE CHANGES WITHOUT FURTHER NOTICE TO ANY PRODUCTS HEREIN TO IMPROVE RELIABILITY, FUNCTION, OR DESIGN. FAIRCHILD DOES NOT ASSUME ANY LIABILITY ARISING OUT OF THE APPLICATION OR USE OF ANY PRODUCT OR CIRCUIT DESCRIBED HEREIN; NEITHER DOES IT CONVEY ANY LICENSE UNDER ITS PATENT RIGHTS, NOR THE RIGHTS OF OTHERS. THESE SPECIFICATIONS DO NOT EXPAND THE TERMS OF FAIRCHILD'S WORLDWIDE TERMS AND CONDITIONS, SPECIFICALLY THE WARRANTY THEREIN, WHICH COVERS THESE PRODUCTS.

LIFE SUPPORT POLICY

FAIRCHILD'S PRODUCTS ARE NOT AUTHORIZED FOR USE AS CRITICAL COMPONENTS IN LIFE SUPPORT DEVICES OR SYSTEMS WITHOUT THE EXPRESS WRITTEN APPROVAL OF FAIRCHILD SEMICONDUCTOR CORPORATION.

As used herein:

1. Life support devices or systems are devices or systems which, (a) are intended for surgical implant into the body or (b) support or sustain life, and (c) whose failure to perform when properly used in accordance with instructions for use provided in the labeling, can be reasonably expected to result in a significant injury of the user.
2. A critical component in any component of a life support, device, or system whose failure to perform can be reasonably expected to cause the failure of the life support device or system, or to affect its safety or effectiveness.

ANTI-COUNTERFEITING POLICY

Fairchild Semiconductor Corporation's Anti-Counterfeiting Policy. Fairchild's Anti-Counterfeiting Policy is also stated on our external website, www.fairchildsemi.com, under Sales Support.

Counterfeiting of semiconductor parts is a growing problem in the industry. All manufacturers of semiconductor products are experiencing counterfeiting of their parts. Customers who inadvertently purchase counterfeit parts experience many problems such as loss of brand reputation, substandard performance, failed applications, and increased cost of production and manufacturing delays. Fairchild is taking strong measures to protect ourselves and our customers from the proliferation of counterfeit parts. Fairchild strongly encourages customers to purchase Fairchild parts either directly from Fairchild or from Authorized Fairchild Distributors who are listed by country on our web page cited above. Products customers buy either from Fairchild directly or from Authorized Fairchild Distributors are genuine parts, have full traceability, meet Fairchild's quality standards for handling and storage and provide access to Fairchild's full range of up-to-date technical and product information. Fairchild and our Authorized Distributors will stand behind all warranties and will appropriately address any warranty issues that may arise. Fairchild will not provide any warranty coverage or other assistance for parts bought from Unauthorized Sources. Fairchild is committed to combat this global problem and encourage our customers to do their part in stopping this practice by buying direct or from authorized distributors.

PRODUCT STATUS DEFINITIONS

Definition of Terms

Datasheet Identification	Product Status	Definition
Advance Information	Formative / In Design	Datasheet contains the design specifications for product development. Specifications may change in any manner without notice.
Preliminary	First Production	Datasheet contains preliminary data; supplementary data will be published at a later date. Fairchild Semiconductor reserves the right to make changes at any time without notice to improve design.
No Identification Needed	Full Production	Datasheet contains final specifications. Fairchild Semiconductor reserves the right to make changes at any time without notice to improve the design.
Obsolete	Not In Production	Datasheet contains specifications on a product that is discontinued by Fairchild Semiconductor. The datasheet is for reference information only.

Rev. 161

ON Semiconductor and  are trademarks of Semiconductor Components Industries, LLC dba ON Semiconductor or its subsidiaries in the United States and/or other countries. ON Semiconductor owns the rights to a number of patents, trademarks, copyrights, trade secrets, and other intellectual property. A listing of ON Semiconductor's product/patent coverage may be accessed at www.onsemi.com/site/pdf/Patent-Marking.pdf. ON Semiconductor reserves the right to make changes without further notice to any products herein. ON Semiconductor makes no warranty, representation or guarantee regarding the suitability of its products for any particular purpose, nor does ON Semiconductor assume any liability arising out of the application or use of any product or circuit, and specifically disclaims any and all liability, including without limitation special, consequential or incidental damages. Buyer is responsible for its products and applications using ON Semiconductor products, including compliance with all laws, regulations and safety requirements or standards, regardless of any support or applications information provided by ON Semiconductor. "Typical" parameters which may be provided in ON Semiconductor data sheets and/or specifications can and do vary in different applications and actual performance may vary over time. All operating parameters, including "Typicals" must be validated for each customer application by customer's technical experts. ON Semiconductor does not convey any license under its patent rights nor the rights of others. ON Semiconductor products are not designed, intended, or authorized for use as a critical component in life support systems or any FDA Class 3 medical devices or medical devices with a same or similar classification in a foreign jurisdiction or any devices intended for implantation in the human body. Should Buyer purchase or use ON Semiconductor products for any such unintended or unauthorized application, Buyer shall indemnify and hold ON Semiconductor and its officers, employees, subsidiaries, affiliates, and distributors harmless against all claims, costs, damages, and expenses, and reasonable attorney fees arising out of, directly or indirectly, any claim of personal injury or death associated with such unintended or unauthorized use, even if such claim alleges that ON Semiconductor was negligent regarding the design or manufacture of the part. ON Semiconductor is an Equal Opportunity/Affirmative Action Employer. This literature is subject to all applicable copyright laws and is not for resale in any manner.

PUBLICATION ORDERING INFORMATION

LITERATURE FULFILLMENT:

Literature Distribution Center for ON Semiconductor
19521 E. 32nd Pkwy, Aurora, Colorado 80011 USA
Phone: 303-675-2175 or 800-344-3860 Toll Free USA/Canada
Fax: 303-675-2176 or 800-344-3867 Toll Free USA/Canada
Email: orderlit@onsemi.com

N. American Technical Support: 800-282-9855 Toll Free
USA/Canada
Europe, Middle East and Africa Technical Support:
Phone: 421 33 790 2910
Japan Customer Focus Center
Phone: 81-3-5817-1050

ON Semiconductor Website: www.onsemi.com
Order Literature: <http://www.onsemi.com/orderlit>
For additional information, please contact your local
Sales Representative

Mouser Electronics

Authorized Distributor

Click to View Pricing, Inventory, Delivery & Lifecycle Information:

[ON Semiconductor:](#)

[FAN5640S7X](#)

Компания «Life Electronics» занимается поставками электронных компонентов импортного и отечественного производства от производителей и со складов крупных дистрибьюторов Европы, Америки и Азии.

С конца 2013 года компания активно расширяет линейку поставок компонентов по направлению коаксиальный кабель, кварцевые генераторы и конденсаторы (керамические, пленочные, электролитические), за счёт заключения дистрибьюторских договоров

Мы предлагаем:

- Конкурентоспособные цены и скидки постоянным клиентам.
- Специальные условия для постоянных клиентов.
- Подбор аналогов.
- Поставку компонентов в любых объемах, удовлетворяющих вашим потребностям.
- Приемлемые сроки поставки, возможна ускоренная поставка.
- Доставку товара в любую точку России и стран СНГ.
- Комплексную поставку.
- Работу по проектам и поставку образцов.
- Формирование склада под заказчика.
- Сертификаты соответствия на поставляемую продукцию (по желанию клиента).
- Тестирование поставляемой продукции.
- Поставку компонентов, требующих военную и космическую приемку.
- Входной контроль качества.
- Наличие сертификата ISO.

В составе нашей компании организован Конструкторский отдел, призванный помогать разработчикам, и инженерам.

Конструкторский отдел помогает осуществить:

- Регистрацию проекта у производителя компонентов.
- Техническую поддержку проекта.
- Защиту от снятия компонента с производства.
- Оценку стоимости проекта по компонентам.
- Изготовление тестовой платы монтаж и пусконаладочные работы.



Тел: +7 (812) 336 43 04 (многоканальный)

Email: org@lifeelectronics.ru