



Device Overview

The 89HPES48H12AG2 is a member of the IDT PRECISE™ family of PCI Express® switching solutions. The PES48H12AG2 is a 48-lane, 12-port system interconnect switch optimized for PCI Express Gen2 packet switching in high-performance applications, supporting multiple simultaneous peer-to-peer traffic flows. Target applications include servers, storage, communications, embedded systems, and multi-host or intelligent I/O based systems with inter-domain communication.

Features

◆ High Performance Non-Blocking Switch Architecture

- 48-lane 12-port PCIe switch
 - Six x8 ports switch ports each of which can bifurcate to two x4 ports (total of twelve x4 ports)
- Integrated SerDes supports 5.0 GT/s Gen2 and 2.5 GT/s Gen1 operation
- Delivers up to 48 GBps (384 Gbps) of switching capacity
- Supports 128 Bytes to 2 KB maximum payload size
- Low latency cut-through architecture
- Supports one virtual channel and eight traffic classes

◆ Standards and Compatibility

- PCI Express Base Specification 2.0 compliant
- Implements the following optional PCI Express features
 - Advanced Error Reporting (AER) on all ports
 - End-to-End CRC (ECRC)
 - Access Control Services (ACS)
 - Power Budgeting Enhanced Capability
 - Device Serial Number Enhanced Capability
 - Sub-System ID and Sub-System Vendor ID Capability
 - Internal Error Reporting ECN
 - Multicast ECN
 - VGA and ISA enable
 - L0s and L1 ASPM
 - ARI ECN

◆ Port Configurability

- x4 and x8 ports
 - Ability to merge adjacent x4 ports to create a x8 port
- Automatic per port link width negotiation (x8 → x4 → x2 → x1)
- Crosslink support
- Automatic lane reversal
- Autonomous and software managed link width and speed control
- Per lane SerDes configuration

- De-emphasis
- Receive equalization
- Drive strength

◆ Switch Partitioning

- IDT proprietary feature that creates logically independent switches in the device
- Supports up to 12 fully independent switch partitions
- Configurable downstream port device numbering
- Supports dynamic reconfiguration of switch partitions
 - Dynamic port reconfiguration — downstream, upstream
 - Dynamic migration of ports between partitions
 - Movable upstream port within and between switch partitions

◆ Initialization / Configuration

- Supports Root (BIOS, OS, or driver), Serial EEPROM, or SMBus switch initialization
- Common switch configurations are supported with pin strapping (no external components)
- Supports in-system Serial EEPROM initialization/programming

◆ Quality of Service (QoS)

- Port arbitration
 - Round robin
- Request metering
 - IDT proprietary feature that balances bandwidth among switch ports for maximum system throughput
- High performance switch core architecture
 - Combined Input Output Queued (CIOQ) switch architecture with large buffers

◆ Multicast

- Compliant to the PCI-SIG multicast ECN
- Supports arbitrary multicasting of Posted transactions
- Supports 64 multicast groups
- Multicast overlay mechanism support
- ECRC regeneration support

◆ Clocking

- Supports 100 MHz and 125 MHz reference clock frequencies
- Flexible port clocking modes
 - Common clock
 - Non-common clock
 - Local port clock with SSC and port reference clock input

◆ Hot-Plug and Hot Swap

- Hot-plug controller on all ports
 - Hot-plug supported on all downstream switch ports
- All ports support hot-plug using low-cost external I²C I/O expanders

- Direct package pin support for hot-plug on 5 ports
- Configurable presence detect supports card and cable applications
- GPE output pin for hot-plug event notification
 - *Enables SCI/SMI generation for legacy operating system support*
- Hot-swap capable I/O
- ◆ **Power Management**
 - Supports D0, D3hot and D3 power management states
 - Active State Power Management (ASPM)
 - *Supports L0, L0s, L1, L2/L3 Ready and L3 link states*
 - *Configurable L0s and L1 entry timers allow performance/power-savings tuning*
 - Supports PCI Express Power Budgeting Capability
 - SerDes power savings
 - *Supports low swing / half-swing SerDes operation*
 - *SerDes optionally turned-off in D3hot*
 - *SerDes associated with unused ports are turned-off*
 - *SerDes associated with unused lanes are placed in a low power state*
- ◆ **54 General Purpose I/O**
- ◆ **Reliability, Availability and Serviceability (RAS)**
 - ECRC support
 - AER on all ports
 - SECDED ECC protection on all internal RAMs
 - End-to-end data path parity protection
 - Checksum Serial EEPROM content protected
 - Autonomous link reliability (preserves system operation in the presence of faulty links)
 - Ability to generate an interrupt (INTx or MSI) on link up/down transitions
- ◆ **Test and Debug**
 - On-chip link activity and status outputs available for several ports including the upstream ports
 - Per port link activity and status outputs available using external I²C I/O expander for all remaining ports
 - SerDes test modes
 - Supports IEEE 1149.6 AC JTAG and IEEE 1149.1 JTAG

◆ Power Supplies

- Requires only two power supply voltages (1.0 V and 2.5 V)
Note that a 3.3V is preferred for V_{DD}I/O
- No power sequencing requirements

◆ Packaged in a 35mm x 35mm 1156-ball Flip Chip BGA with 1mm ball spacing

Product Description

Utilizing standard PCI Express interconnect, the PES48H12AG2 provides the most efficient fan-out solution for applications requiring high throughput, low latency, and simple board layout with a minimum number of board layers. It provides 48 GBps (384 Gbps) of aggregated, full-duplex switching capacity through 48 integrated serial lanes, using proven and robust IDT technology. Each lane provides 5 GT/s of bandwidth in both directions and is fully compliant with PCI Express Base Specification, Revision 2.0.

The PES48H12AG2 is based on a flexible and efficient layered architecture. The PCI Express layer consists of SerDes, Physical, Data Link and Transaction layers in compliance with PCI Express Base specification Revision 2.0. The PES48H12AG2 can operate either as a store and forward or cut-through switch. It supports eight Traffic Classes (TCs) and one Virtual Channel (VC) with sophisticated resource management to enable efficient switching and I/O connectivity for servers, storage, and embedded processors with limited connectivity.

The PES48H12AG2 is a *partitionable* PCIe switch. This means that in addition to operating as a standard PCI express switch, the PES48H12AG2 ports may be partitioned into groups that logically operate as completely independent PCIe switches. [Figure 2](#) illustrates a three partition PES48H12AG2 configuration.

Block Diagram



48 PCI Express Lanes
Up to 6 x8 ports or 12 x4 Ports

Figure 1 Internal Block Diagram

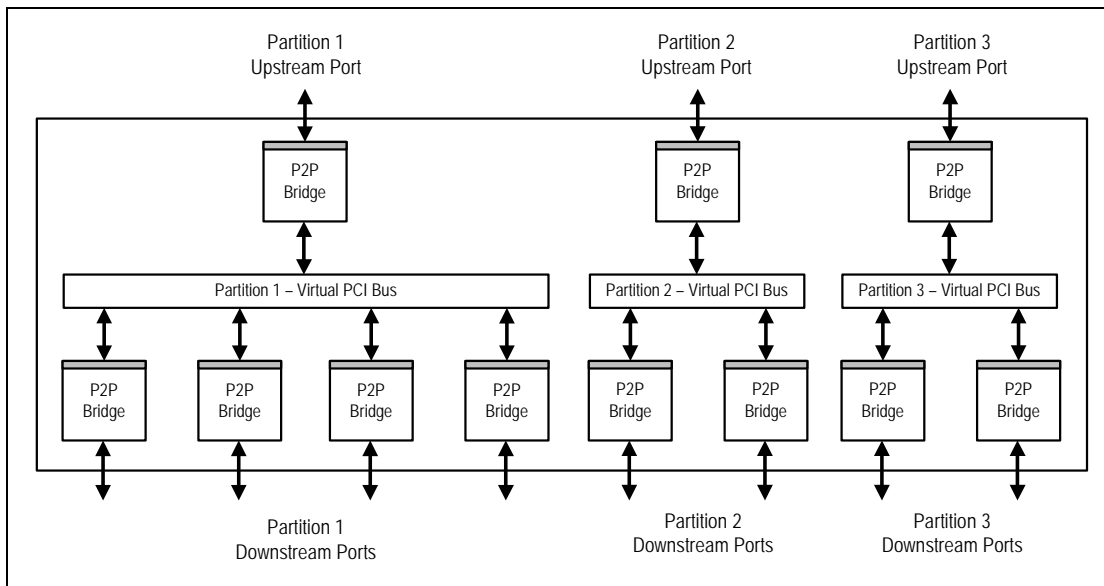

Figure 2 Example of Usage of Switch Partitioning

SMBus Interface

The PES48H12AG2 contains two SMBus interfaces. The slave interface provides full access to the configuration registers in the PES48H12AG2, allowing every configuration register in the device to be read or written by an external agent. The master interface allows the default configuration register values of the PES48H12AG2 to be overridden following a reset with values programmed in an external serial EEPROM. The master interface is also used by an external Hot-Plug I/O expander.

Six pins make up each of the two SMBus interfaces. These pins consist of an SMBus clock pin, an SMBus data pin, and 4 SMBus address pins. In the slave interface, these address pins allow the SMBus address to which the device responds to be configured. In the master interface, these address pins allow the SMBus address of the serial configuration EEPROM from which data is loaded to be configured. The SMBus address is set up on negation of PERSTN by sampling the corresponding address pins. When the pins are sampled, the resulting address is assigned as shown in Table 1.

Bit	Slave SMBus Address	Master SMBus Address
1	SSMBADDR[1]	MSMBADDR[1]
2	SSMBADDR[2]	MSMBADDR[2]
3	SSMBADDR[3]	MSMBADDR[3]
4	0	MSMBADDR[4]
5	SSMBADDR[5]	1
6	1	0
7	1	1

Table 1 Master and Slave SMBus Address Assignment

As shown in Figure 3, the master and slave SMBuses may only be used in a split configuration.



Figure 3 Split SMBus Interface Configuration

The switch's SMBus master interface does not support SMBus arbitration. As a result, the switch's SMBus master must be the only master in the SMBus lines that connect to the serial EEPROM and I/O expander slaves. In the split configuration, the master and slave SMBuses operate as two independent buses; thus, multi-master arbitration is not required.

Hot-Plug Interface

The PES48H12AG2 supports PCI Express Hot-Plug on each downstream port. To reduce the number of pins required on the device, the PES48H12AG2 utilizes an external I/O expander, such as that used on PC motherboards, connected to the SMBus master interface. Following reset and configuration, whenever the state of a Hot-Plug output needs to be modified, the PES48H12AG2 generates an SMBus transaction to the I/O expander with the new value of all of the outputs. Whenever a Hot-Plug input changes, the I/O expander generates an interrupt which is received on the IOEXPINTN input pin (alternate function of GPIO) of the PES48H12AG2. In response to an I/O expander interrupt, the PES48H12AG2 generates an SMBus transaction to read the state of all of the Hot-Plug inputs from the I/O expander.

General Purpose Input/Output

The PES48H12AG2 provides 54 General Purpose Input/Output (GPIO) pins that may be used by the system designer as bit I/O ports. Each GPIO pin may be configured independently as an input or output through software control. Some GPIO pins are shared with other on-chip functions. These alternate functions may be enabled via software, SMBus slave interface, or serial configuration EEPROM.

Pin Description

The following tables list the functions of the pins provided on the PES48H12AG2. Some of the functions listed may be multiplexed onto the same pin. The active polarity of a signal is defined using a suffix. Signals ending with an "N" are defined as being active, or asserted, when at a logic zero (low) level. All other signals (including clocks, buses, and select lines) will be interpreted as being active, or asserted, when at a logic one (high) level.

Signal	Type	Name/Description
PE00RP[3:0] PE00RN[3:0]	I	PCI Express Port 0 Serial Data Receive. Differential PCI Express receive pairs for port 0.
PE00TP[3:0] PE00TN[3:0]	O	PCI Express Port 0 Serial Data Transmit. Differential PCI Express transmit pairs for port 0.
PE01RP[3:0] PE01RN[3:0]	I	PCI Express Port 1 Serial Data Receive. Differential PCI Express receive pairs for port 1. When port 0 is merged with port 1, these signals become port 0 receive pairs for lanes 4 through 7.
PE01TP[3:0] PE01TN[3:0]	O	PCI Express Port 1 Serial Data Transmit. Differential PCI Express transmit pairs for port 1. When port 0 is merged with port 1, these signals become port 0 transmit pairs for lanes 4 through 7.
PE02RP[3:0] PE02RN[3:0]	I	PCI Express Port 2 Serial Data Receive. Differential PCI Express receive pairs for port 2.
PE02TP[3:0] PE02TN[3:0]	O	PCI Express Port 2 Serial Data Transmit. Differential PCI Express transmit pairs for port 2.
PE03RP[3:0] PE03RN[3:0]	I	PCI Express Port 3 Serial Data Receive. Differential PCI Express receive pairs for port 3. When port 2 is merged with port 3, these signals become port 2 receive pairs for lanes 4 through 7.
PE03TP[3:0] PE03TN[3:0]	O	PCI Express Port 3 Serial Data Transmit. Differential PCI Express transmit pairs for port 3. When port 2 is merged with port 3, these signals become port 2 transmit pairs for lanes 4 through 7.
PE04RP[3:0] PE04RN[3:0]	I	PCI Express Port 4 Serial Data Receive. Differential PCI Express receive pairs for port 4.
PE04TP[3:0] PE04TN[3:0]	O	PCI Express Port 4 Serial Data Transmit. Differential PCI Express transmit pairs for port 4.
PE05RP[3:0] PE05RN[3:0]	I	PCI Express Port 5 Serial Data Receive. Differential PCI Express receive pairs for port 5. When port 4 is merged with port 5, these signals become port 4 receive pairs for lanes 4 through 7.
PE05TP[3:0] PE05TN[3:0]	O	PCI Express Port 5 Serial Data Transmit. Differential PCI Express transmit pairs for port 5. When port 4 is merged with port 5, these signals become port 4 transmit pairs for lanes 4 through 7.
PE06RP[3:0] PE06RN[3:0]	I	PCI Express Port 6 Serial Data Receive. Differential PCI Express receive pairs for port 6.
PE06TP[3:0] PE06TN[3:0]	O	PCI Express Port 6 Serial Data Transmit. Differential PCI Express transmit pairs for port 6.

Table 2 PCI Express Interface Pins (Part 1 of 2)

Signal	Type	Name/Description
PE07RP[3:0] PE07RN[3:0]	I	PCI Express Port 7 Serial Data Receive. Differential PCI Express receive pairs for port 7. When port 6 is merged with port 7, these signals become port 6 receive pairs for lanes 4 through 7.
PE07TP[3:0] PE07TN[3:0]	O	PCI Express Port 7 Serial Data Transmit. Differential PCI Express transmit pairs for port 7. When port 6 is merged with port 7, these signals become port 6 transmit pairs for lanes 4 through 7.
PE08RP[3:0] PE08RN[3:0]	I	PCI Express Port 8 Serial Data Receive. Differential PCI Express receive pairs for port 8.
PE08TP[3:0] PE08TN[3:0]	O	PCI Express Port 8 Serial Data Transmit. Differential PCI Express transmit pairs for port 8.
PE09RP[3:0] PE09RN[3:0]	I	PCI Express Port 9 Serial Data Receive. Differential PCI Express receive pairs for port 9. When port 8 is merged with port 9, these signals become port 8 receive pairs for lanes 4 through 7.
PE09TP[3:0] PE09TN[3:0]	O	PCI Express Port 9 Serial Data Transmit. Differential PCI Express transmit pairs for port 9. When port 8 is merged with port 9, these signals become port 8 transmit pairs for lanes 4 through 7.
PE10RP[3:0] PE10RN[3:0]	I	PCI Express Port 10 Serial Data Receive. Differential PCI Express receive pairs for port 10.
PE10TP[3:0] PE10TN[3:0]	O	PCI Express Port 10 Serial Data Transmit. Differential PCI Express transmit pairs for port 10.
PE11RP[3:0] PE11RN[3:0]	I	PCI Express Port 11 Serial Data Receive. Differential PCI Express receive pairs for port 11. When port 10 is merged with port 11, these signals become port 10 receive pairs for lanes 4 through 7.
PE11TP[3:0] PE11TN[3:0]	O	PCI Express Port 11 Serial Data Transmit. Differential PCI Express transmit pairs for port 11. When port 10 is merged with port 11, these signals become port 10 transmit pairs for lanes 4 through 7.

Table 2 PCI Express Interface Pins (Part 2 of 2)

Signal	Type	Name/Description
GCLKN[1:0] GCLKP[1:0]	I	Global Reference Clock. Differential reference clock input pair. This clock is used as the reference clock by on-chip PLLs to generate the clocks required for the system logic. The frequency of the differential reference clock is determined by the GCLKFSEL signal.
P[11:0]CLKN P[11:0]CLKP	I	Port [11:0] Reference Clocks. Differential reference clock pairs associated with ports.

Table 3 Reference Clock Pins

Signal	Type	Name/Description
MSMBADDR[4:1]	I	Master SMBus Address. These pins determine the SMBus address of the serial EEPROM from which configuration information is loaded.
MSMBCLK	I/O	Master SMBus Clock. This bidirectional signal is used to synchronize transfers on the master SMBus.
MSMBDAT	I/O	Master SMBus Data. This bidirectional signal is used for data on the master SMBus.

Table 4 SMBus Interface Pins (Part 1 of 2)

Signal	Type	Name/Description
SSMBADDR[5,3:1]	I	Slave SMBus Address. These pins determine the SMBus address to which the slave SMBus interface responds.
SSMBCLK	I/O	Slave SMBus Clock. This bidirectional signal is used to synchronize transfers on the slave SMBus.
SSMBDAT	I/O	Slave SMBus Data. This bidirectional signal is used for data on the slave SMBus.

Table 4 SMBus Interface Pins (Part 2 of 2)

Signal	Type	Name/Description
GPIO[0]	I/O	General Purpose I/O. This pin can be configured as a general purpose I/O pin. Alternate function pin name: PART0PERSTN Alternate function pin type: Input/Output Alternate function: Assertion of this signal initiated a partition fundamental reset in the corresponding partition.
GPIO[1]	I/O	General Purpose I/O. This pin can be configured as a general purpose I/O pin. Alternate function pin name: PART1PERSTN Alternate function pin type: Input/Output Alternate function: Assertion of this signal initiated a partition fundamental reset in the corresponding partition.
GPIO[2]	I/O	General Purpose I/O. This pin can be configured as a general purpose I/O pin. Alternate function pin name: PART2PERSTN Alternate function pin type: Input/Output Alternate function: Assertion of this signal initiated a partition fundamental reset in the corresponding partition.
GPIO[3]	I/O	General Purpose I/O. This pin can be configured as a general purpose I/O pin. Alternate function pin name: PART3PERSTN Alternate function pin type: Input/Output Alternate function: Assertion of this signal initiated a partition fundamental reset in the corresponding partition.
GPIO[4]	I	General Purpose I/O. This pin can be configured as a general purpose I/O pin. 1st Alternate function — Reserved 2nd Alternate function pin name: POLINKUPN 2nd Alternate function pin type: Output 2nd Alternate function: Port 0 Link Up Status output.
GPIO[5]	O	General Purpose I/O. This pin can be configured as a general purpose I/O pin. 1st Alternate function pin name: GPEN 1st Alternate function pin type: Output 1st Alternate function: Hot-plug general purpose even output. 2nd Alternate function pin name: P0ACTIVEN 2nd Alternate function pin type: Output 2nd Alternate function: Port 0 Link Active Status Output.
GPIO[6]	I	General Purpose I/O. This pin can be configured as a general purpose I/O pin.
GPIO[7]	I/O	General Purpose I/O. This pin can be configured as a general purpose I/O pin.

Table 5 General Purpose I/O Pins (Part 1 of 7)

Signal	Type	Name/Description
GPIO[8]	I	General Purpose I/O. This pin can be configured as a general purpose I/O pin. Alternate function pin name: IOEXPINTN Alternate function pin type: Input Alternate function: IO expander interrupt.
GPIO[9]	I	General Purpose I/O. This pin can be configured as a general purpose I/O pin. Alternate function pin name: HPOAPN Alternate function pin type: Input Alternate function: Hot Plug Signal Group 0 Attention Push Button Input.
GPIO[10]	I	General Purpose I/O. This pin can be configured as a general purpose I/O pin. Alternate function pin name: HPOPDN Alternate function pin type: Input Alternate function: Hot Plug Signal Group 0 Presence Detect Input.
GPIO[11]	I	General Purpose I/O. This pin can be configured as a general purpose I/O pin. Alternate function pin name: HPOPFN Alternate function pin type: Input Alternate function: Hot Plug Signal Group 0 Power Fault Input.
GPIO[12]	I	General Purpose I/O. This pin can be configured as a general purpose I/O pin. Alternate function pin name: HPOPWRGDN Alternate function pin type: Input Alternate function: Hot Plug Signal Group 0 Power Good Input.
GPIO[13]	I	General Purpose I/O. This pin can be configured as a general purpose I/O pin. Alternate function pin name: HPOMRLN Alternate function pin type: Input Alternate function: Hot Plug Signal Group 0 Manually Operated Retention latch Input.
GPIO[14]	O	General Purpose I/O. This pin can be configured as a general purpose I/O pin. Alternate function pin name: HPOAIN Alternate function pin type: Output Alternate function: Hot Plug Signal Group 0 Attention Indicator Output.
GPIO[15]	O	General Purpose I/O. This pin can be configured as a general purpose I/O pin. Alternate function pin name: HPOPIN Alternate function pin type: Output Alternate function: Hot Plug Signal Group 0 Power Indicator Output.
GPIO[16]	O	General Purpose I/O. This pin can be configured as a general purpose I/O pin. Alternate function pin name: HPOPEP Alternate function pin type: Output Alternate function: Hot Plug Signal Group 0 Power Enable Output.
GPIO[17]	O	General Purpose I/O. This pin can be configured as a general purpose I/O pin. Alternate function pin name: HPORSTN Alternate function pin type: Output Alternate function: Hot Plug Signal Group 0 Reset Output.

Table 5 General Purpose I/O Pins (Part 2 of 7)

Signal	Type	Name/Description
GPIO[18]	I	General Purpose I/O. This pin can be configured as a general purpose I/O pin. Alternate function pin name: HP1APN Alternate function pin type: Input Alternate function: Hot Plug Signal Group 1 Attention Push Button Input.
GPIO[19]	I	General Purpose I/O. This pin can be configured as a general purpose I/O pin. Alternate function pin name: HP1PDN Alternate function pin type: Input Alternate function: Hot Plug Signal Group 1 Presence Detect Input.
GPIO[20]	I	General Purpose I/O. This pin can be configured as a general purpose I/O pin. Alternate function pin name: HP1PFN Alternate function pin type: Input Alternate function: Hot Plug Signal Group 1 Power Fault Input.
GPIO[21]	I	General Purpose I/O. This pin can be configured as a general purpose I/O pin. Alternate function pin name: HP1PWRGDN Alternate function pin type: Input Alternate function: Hot Plug Signal Group 1 Power Good Input.
GPIO[22]	I/O	General Purpose I/O. This pin can be configured as a general purpose I/O pin. 1st Alternate function pin name: HP1MRLN 1st Alternate function pin type: Input 1st Alternate function: Hot Plug Signal Group 1 Manually Operated Retention. 2nd Alternate function pin name: P1LINKUPN 2nd Alternate function pin type: Output 2nd Alternate function: Port 1 Link Up Status Output.
GPIO[23]	O	General Purpose I/O. This pin can be configured as a general purpose I/O pin. 1st Alternate function pin name: HP1AIN 1st Alternate function pin type: Output 1st Alternate function: Hot Plug Signal Group 1 Attention Indicator Output. 2nd Alternate function pin name: P1ACTIVEN 2nd Alternate function pin type: Output 2nd Alternate function: Port 1 Link Active Status Output.
GPIO[24]	O	General Purpose I/O. This pin can be configured as a general purpose I/O pin. 1st Alternate function pin name: HP1PIN 1st Alternate function pin type: Output 1st Alternate function: Hot Plug Signal Group 1 Power Indicator Output. 2nd Alternate function pin name: P2LINKUPN 2nd Alternate function pin type: Output 2nd Alternate function: Port 2 Link Up Status Output.
GPIO[25]	O	General Purpose I/O. This pin can be configured as a general purpose I/O pin. 1st Alternate function pin name: HP1PEP 1st Alternate function pin type: Output 1st Alternate function: Hot Plug Signal Group 1 Power Enable Output. 2nd Alternate function pin name: P2ACTIVEN 2nd Alternate function pin type: Output 2nd Alternate function: Port 2 Link Active Status Output.

Table 5 General Purpose I/O Pins (Part 3 of 7)

Signal	Type	Name/Description
GPIO[26]	O	General Purpose I/O. This pin can be configured as a general purpose I/O pin. 1st Alternate function pin name: HP1RSTN 1st Alternate function pin type: Output 1st Alternate function: Hot Plug Signal Group 1 Reset Output. 2nd Alternate function pin name: P3LINKUPN 2nd Alternate function pin type: Output 2nd Alternate function: Port 3 Link Up Status Output.
GPIO[27]	I/O	General Purpose I/O. This pin can be configured as a general purpose I/O pin. 1st Alternate function pin name: HP2APN 1st Alternate function pin type: Input 1st Alternate function: Hot Plug Signal Group 2 Attention Push Button Input. 2nd Alternate function pin name: P3ACTIVEN 2nd Alternate function pin type: Output 2nd Alternate function: Port 3 Link Active Status Output.
GPIO[28]	I/O	General Purpose I/O. This pin can be configured as a general purpose I/O pin. 1st Alternate function pin name: HP2PDN 1st Alternate function pin type: Input 1st Alternate function: Hot Plug Signal Group 2 Presence Detect Input. 2nd Alternate function pin name: P4LINKUPN 2nd Alternate function pin type: Output 2nd Alternate function: Port 4 Link Up Status Output.
GPIO[29]	I/O	General Purpose I/O. This pin can be configured as a general purpose I/O pin. 1st Alternate function pin name: HP2PFN 1st Alternate function pin type: Input 1st Alternate function: Hot Plug Signal Group 2 Power Fault Input. 2nd Alternate function pin name: P4ACTIVEN 2nd Alternate function pin type: Output 2nd Alternate function: Port 4 Link Active Status Output.
GPIO[30]	I/O	General Purpose I/O. This pin can be configured as a general purpose I/O pin. 1st Alternate function pin name: HP2PWRGDN 1st Alternate function pin type: Input 1st Alternate function: Hot Plug Signal Group 2 Power Good Input. 2nd Alternate function pin name: P5LINKUPN 2nd Alternate function pin type: Output 2nd Alternate function: Port 5 Link Up Status Output.
GPIO[31]	I/O	General Purpose I/O. This pin can be configured as a general purpose I/O pin. 1st Alternate function pin name: HP2MRLN 1st Alternate function pin type: Input 1st Alternate function: Hot Plug Signal Group 2 Manually Operated Retention Latch Input. 2nd Alternate function pin name: P5ACTIVEN 2nd Alternate function pin type: Output 2nd Alternate function: Port 5 Link Active Status Output.

Table 5 General Purpose I/O Pins (Part 4 of 7)

Signal	Type	Name/Description
GPIO[32]	I/O	General Purpose I/O. This pin can be configured as a general purpose I/O pin. 1st Alternate function pin name: HP2AIN 1st Alternate function pin type: Output 1st Alternate function: Hot Plug Signal Group 2 Attention Indicator Output. 2nd Alternate function pin name: P6LINKUPN 2nd Alternate function pin type: Output 2nd Alternate function: Port 6 Link Up Status Output.
GPIO[33]	I/O	General Purpose I/O. This pin can be configured as a general purpose I/O pin. 1st Alternate function pin name: HP2PIN 1st Alternate function pin type: Output 1st Alternate function: Hot Plug Signal Group 2 Power Indicator Output. 2nd Alternate function pin name: P6ACTIVEN 2nd Alternate function pin type: Output 2nd Alternate function: Port 6 Link Active Status Output.
GPIO[34]	I/O	General Purpose I/O. This pin can be configured as a general purpose I/O pin. 1st Alternate function pin name: HP2PEP 1st Alternate function pin type: Output 1st Alternate function: Hot Plug Signal Group 2 Power Enable Output. 2nd Alternate function pin name: P7LINKUPN 2nd Alternate function pin type: Output 2nd Alternate function: Port 7 Link Up Status Output.
GPIO[35]	I/O	General Purpose I/O. This pin can be configured as a general purpose I/O pin. 1st Alternate function pin name: HP2RSTN 1st Alternate function pin type: Output 1st Alternate function: Hot Plug Signal Group 2 Reset Output. 2nd Alternate function pin name: P7ACTIVEN 2nd Alternate function pin type: Output 2nd Alternate function: Port 7 Link Active Status Output.
GPIO[36]	I/O	General Purpose I/O. This pin can be configured as a general purpose I/O pin. 1st Alternate function pin name: HP3APN 1st Alternate function pin type: Input 1st Alternate function: Hot Plug Signal Group 3 Attention Push Button Input. 2nd Alternate function pin name: P8LINKUPN 2nd Alternate function pin type: Output 2nd Alternate function: Port 8 Link Up Status Output.
GPIO[37]	I/O	General Purpose I/O. This pin can be configured as a general purpose I/O pin. 1st Alternate function pin name: HP3PDN 1st Alternate function pin type: Input 1st Alternate function: Hot Plug Signal Group 3 Presence Detect Input. 2nd Alternate function pin name: P8ACTIVEN 2nd Alternate function pin type: Output 2nd Alternate function: Port 8 Link Active Status Output.
GPIO[38]	I/O	General Purpose I/O. This pin can be configured as a general purpose I/O pin. 1st Alternate function pin name: HP3PFN 1st Alternate function pin type: Input 1st Alternate function: Hot Plug Signal Group 3 Power Fault Input. 2nd Alternate function pin name: P9LINKUPN 2nd Alternate function pin type: Output 2nd Alternate function: Port 9 Link Up Status Output.

Table 5 General Purpose I/O Pins (Part 5 of 7)

Signal	Type	Name/Description
GPIO[39]	I/O	General Purpose I/O. This pin can be configured as a general purpose I/O pin. 1st Alternate function pin name: HP3PWRGDN 1st Alternate function pin type: Input 1st Alternate function: Hot Plug Signal Group 3 Power Good Input. 2nd Alternate function pin name: P9ACTIVEN 2nd Alternate function pin type: Output 2nd Alternate function: Port 9 Link Active Status Output.
GPIO[40]	I/O	General Purpose I/O. This pin can be configured as a general purpose I/O pin. 1st Alternate function pin name: HP3MRLN 1st Alternate function pin type: Input 1st Alternate function: Hot Plug Signal Group 3 Manually Operated Retention Latch Input. 2nd Alternate function pin name: P10LINKUPN 2nd Alternate function pin type: Output 2nd Alternate function: Port 10 Link Up Status Output.
GPIO[41]	I/O	General Purpose I/O. This pin can be configured as a general purpose I/O pin. 1st Alternate function pin name: HP3AIN 1st Alternate function pin type: Output 1st Alternate function: Hot Plug Signal Group 3 Attention Indicator Output. 2nd Alternate function pin name: P10ACTIVEN 2nd Alternate function pin type: Output 2nd Alternate function: Port 10 Link Active Status Output.
GPIO[42]	I/O	General Purpose I/O. This pin can be configured as a general purpose I/O pin. 1st Alternate function pin name: HP3PIN 1st Alternate function pin type: Output 1st Alternate function: Hot Plug Signal Group 3 Power Indicator Output. 2nd Alternate function pin name: P11LINKUPN 2nd Alternate function pin type: Output 2nd Alternate function: Port 11 Link Up Status Output.
GPIO[43]	I/O	General Purpose I/O. This pin can be configured as a general purpose I/O pin. 1st Alternate function pin name: HP3PEP 1st Alternate function pin type: Output 1st Alternate function: Hot Plug Signal Group 3 Power Enable Output. 2nd Alternate function pin name: P11ACTIVEN 2nd Alternate function pin type: Output 2nd Alternate function: Port 11 Link Active Status Output.
GPIO[44]	I/O	General Purpose I/O. This pin can be configured as a general purpose I/O pin. Alternate function pin name: HP3RSTN Alternate function pin type: Output Alternate function: Hot Plug Signal Group 3 Reset Output.
GPIO[45]	I/O	General Purpose I/O. This pin can be configured as a general purpose I/O pin. Alternate function pin name: HP4APN Alternate function pin type: Input Alternate function: Hot Plug Signal Group 4 Attention Push Button Input.
GPIO[46]	I/O	General Purpose I/O. This pin can be configured as a general purpose I/O pin. Alternate function pin name: HP4PDN Alternate function pin type: Input Alternate function: Hot Plug Signal Group 4 Presence Detect Input.

Table 5 General Purpose I/O Pins (Part 6 of 7)

Signal	Type	Name/Description
GPIO[47]	I/O	General Purpose I/O. This pin can be configured as a general purpose I/O pin. Alternate function pin name: HP4PFN Alternate function pin type: Input Alternate function: Hot Plug Signal Group 4 Power Fault Input.
GPIO[48]	I/O	General Purpose I/O. This pin can be configured as a general purpose I/O pin. Alternate function pin name: HP4PWRGDN Alternate function pin type: Input Alternate function: Hot Plug Signal Group 4 Power Good Input.
GPIO[49]	I/O	General Purpose I/O. This pin can be configured as a general purpose I/O pin. Alternate function pin name: HP4MRLN Alternate function pin type: Input Alternate function: Hot Plug Signal Group 4 Manually Operated Retention Latch Input.
GPIO[50]	I/O	General Purpose I/O. This pin can be configured as a general purpose I/O pin. Alternate function pin name: HP4AIN Alternate function pin type: Output Alternate function: Hot Plug Signal Group 4 Attention Indicator Output.
GPIO[51]	I/O	General Purpose I/O. This pin can be configured as a general purpose I/O pin. Alternate function pin name: HP4PIN Alternate function pin type: Output Alternate function: Hot Plug Signal Group 4 Power Indicator Output.
GPIO[52]	I/O	General Purpose I/O. This pin can be configured as a general purpose I/O pin. Alternate function pin name: HP4PEP Alternate function pin type: Output Alternate function: Hot Plug Signal Group 4 Power Enable Output.
GPIO[53]	I/O	General Purpose I/O. This pin can be configured as a general purpose I/O pin. Alternate function pin name: HP4RSTN Alternate function pin type: Output Alternate function: Hot Plug Signal Group 4 Reset Output.

Table 5 General Purpose I/O Pins (Part 7 of 7)

Signal	Type	Name/Description
CLKMODE[2:0]		Clock Mode. These signals determine the port clocking mode used by ports of the device.
GCLKFSEL	I	Global Clock Frequency Select. These signals select the frequency of the GCLKP and GCLKN signals. 0x0 100 MHz 0x1 125 MHz
MSMBSMODE	I	Master SMBus Slow Mode. The assertion of this pin indicates that the master SMBus should operate at 100 KHz instead of 400 KHz. This value may not be overridden.

Table 6 System Pins (Part 1 of 3)

Signal	Type	Name/Description
P01MERGEN	I	Port 0 and 1 Merge. P01MERGEN is an active low signal. It is pulled low internally. When this pin is low, port 0 is merged with port 1 to form a single x8 port. The Serdes lanes associated with port 1 become lanes 4 through 7 of port 0. When this pin is high, port 0 and port 1 are not merged, and each operates as a single x4 port.
P23MERGEN	I	Port 2 and 3 Merge. P23MERGEN is an active low signal. It is pulled low internally. When this pin is low, port 2 is merged with port 3 to form a single x8 port. The Serdes lanes associated with port 3 become lanes 4 through 7 of port 2. When this pin is high, port 2 and port 3 are not merged, and each operates as a single x4 port.
P45MERGEN	I	Port 4 and 5 Merge. P45MERGEN is an active low signal. It is pulled low internally. When this pin is low, port 4 is merged with port 5 to form a single x8 port. The Serdes lanes associated with port 5 become lanes 4 through 7 of port 4. When this pin is high, port 4 and port 5 are not merged, and each operates as a single x4 port.
P67MERGEN	I	Port 6 and 7 Merge. P67MERGEN is an active low signal. It is pulled low internally. When this pin is low, port 6 is merged with port 7 to form a single x8 port. The Serdes lanes associated with port 7 become lanes 4 through 7 of port 6. When this pin is high, port 6 and port 7 are not merged, and each operates as a single x4 port.
P89MERGEN	I	Port 8 and 9 Merge. P89MERGEN is an active low signal. It is pulled low internally. When this pin is low, port 8 is merged with port 9 to form a single x8 port. The Serdes lanes associated with port 9 become lanes 4 through 7 of port 8. When this pin is high, port 8 and port 9 are not merged, and each operates as a single x4 port.
P1011MERGEN	I	Port 10 and 11 Merge. P1011MERGEN is an active low signal. It is pulled low internally. When this pin is low, port 10 is merged with port 11 to form a single x8 port. The Serdes lanes associated with port 11 become lanes 4 through 7 of port 10. When this pin is high, port 10 and port 11 are not merged, and each operates as a single x4 port.

Table 6 System Pins (Part 2 of 3)

Signal	Type	Name/Description
PERSTN	I	Global Reset. Assertion of this signal resets all logic inside PES48H12AG2.
RSTHALT	I	Reset Halt. When this signal is asserted during a PCI Express fundamental reset, PES48H12AG2 executes the reset procedure and remains in a reset state with the Master and Slave SMBuses active. This allows software to read and write registers internal to the device before normal device operation begins. The device exits the reset state when the RSTHALT bit is cleared in the SWCTL register by an SMBus master.
SWMODE[3:0]	I	Switch Mode. These configuration pins determine the PES48H12AG2 switch operating mode. Note: These pins should be static and not change following the negation of PERSTN. 0x0 - Single partition 0x1 - Single partition with Serial EEPROM initialization 0x2 through 0x7 - Reserved 0x8 - Single partition with port 0 selected as the upstream port (port 2 disabled) 0x9 - Single partition with port 2 selected as the upstream port (port 0 disabled) 0xA - Single partition with Serial EEPROM initialization and port 0 selected as the upstream port (port 2 disabled) 0xB - Single partition with Serial EEPROM initialization and port 2 selected as the upstream port (port 0 disabled) 0xC - Multi-partition 0xD - Multi-partition with Serial EEPROM initialization 0xE - Reserved 0xF - Reserved

Table 6 System Pins (Part 3 of 3)

Signal	Type	Name/Description
JTAG_TCK	I	JTAG Clock. This is an input test clock used to clock the shifting of data into or out of the boundary scan logic or JTAG Controller. JTAG_TCK is independent of the system clock with a nominal 50% duty cycle.
JTAG_TDI	I	JTAG Data Input. This is the serial data input to the boundary scan logic or JTAG Controller.
JTAG_TDO	O	JTAG Data Output. This is the serial data shifted out from the boundary scan logic or JTAG Controller. When no data is being shifted out, this signal is tri-stated.
JTAG_TMS	I	JTAG Mode. The value on this signal controls the test mode select of the boundary scan logic or JTAG Controller.
JTAG_TRST_N	I	JTAG Reset. This active low signal asynchronously resets the boundary scan logic and JTAG TAP Controller. An external pull-up on the board is recommended to meet the JTAG specification in cases where the tester can access this signal. However, for systems running in functional mode, one of the following should occur: 1) actively drive this signal low with control logic 2) statically drive this signal low with an external pull-down on the board

Table 7 Test Pins

Signal	Type	Name/Description
REFRES00	I/O	Port 0 External Reference Resistor. Provides a reference for the Port 0 SerDes bias currents and PLL calibration circuitry. A 3 kOhm +/- 1% resistor should be connected from this pin to ground.
REFRES01	I/O	Port 1 External Reference Resistor. Provides a reference for the Port 1 SerDes bias currents and PLL calibration circuitry. A 3 kOhm +/- 1% resistor should be connected from this pin to ground.
REFRES02	I/O	Port 2 External Reference Resistor. Provides a reference for the Port 2 SerDes bias currents and PLL calibration circuitry. A 3 kOhm +/- 1% resistor should be connected from this pin to ground.
REFRES03	I/O	Port 3 External Reference Resistor. Provides a reference for the Port 3 SerDes bias currents and PLL calibration circuitry. A 3 kOhm +/- 1% resistor should be connected from this pin to ground.
REFRES04	I/O	Port 4 External Reference Resistor. Provides a reference for the Port 4 SerDes bias currents and PLL calibration circuitry. A 3 kOhm +/- 1% resistor should be connected from this pin to ground.
REFRES05	I/O	Port 5 External Reference Resistor. Provides a reference for the Port 5 SerDes bias currents and PLL calibration circuitry. A 3 kOhm +/- 1% resistor should be connected from this pin to ground.
REFRES06	I/O	Port 6 External Reference Resistor. Provides a reference for the Port 6 SerDes bias currents and PLL calibration circuitry. A 3 kOhm +/- 1% resistor should be connected from this pin to ground.
REFRES07	I/O	Port 7 External Reference Resistor. Provides a reference for the Port 7 SerDes bias currents and PLL calibration circuitry. A 3 kOhm +/- 1% resistor should be connected from this pin to ground.
REFRES08	I/O	Port 8 External Reference Resistor. Provides a reference for the Port 8 SerDes bias currents and PLL calibration circuitry. A 3 kOhm +/- 1% resistor should be connected from this pin to ground.
REFRES09	I/O	Port 9 External Reference Resistor. Provides a reference for the Port 9 SerDes bias currents and PLL calibration circuitry. A 3 kOhm +/- 1% resistor should be connected from this pin to ground.
REFRES10	I/O	Port 10 External Reference Resistor. Provides a reference for the Port 10 SerDes bias currents and PLL calibration circuitry. A 3 kOhm +/- 1% resistor should be connected from this pin to ground.
REFRES11	I/O	Port 11 External Reference Resistor. Provides a reference for the Port 11 SerDes bias currents and PLL calibration circuitry. A 3 kOhm +/- 1% resistor should be connected from this pin to ground.
REFRESPLL	I/O	PLL External Reference Resistor. Provides a reference for the PLL bias currents and PLL calibration circuitry. A 3K Ohm +/- 1% resistor should be connected from this pin to ground.
V _{DD} CORE	I	Core V_{DD}. Power supply for core logic (1.0V).
V _{DD} I/O	I	I/O V_{DD}. LVTTTL I/O buffer power supply (2.5V or preferred 3.3V).
V _{DD} PEA	I	PCI Express Analog Power. Serdes analog power supply (1.0V).

Table 8 Power, Ground, and SerDes Resistor Pins (Part 1 of 2)

Signal	Type	Name/Description
V _{DD} PEHA	I	PCI Express Analog High Power. Serdes analog power supply (2.5V).
V _{DD} PETA	I	PCI Express Transmitter Analog Voltage. Serdes transmitter analog power supply (1.0V).
V _{SS}	I	Ground.

Table 8 Power, Ground, and SerDes Resistor Pins (Part 2 of 2)

Pin Characteristics

Note: Some input pads of the switch do not contain internal pull-ups or pull-downs. Unused SMBus and System inputs should be tied off to appropriate levels. This is especially critical for unused control signal inputs which, if left floating, could adversely affect operation. Also, any of these pins left floating can cause a slight increase in power consumption. Finally, unused Serdes (Rx and Tx) pins should be left floating.

Function	Pin Name	Type	Buffer	I/O Type	Internal Resistor ¹	Notes
PCI Express Interface	PE00RN[3:0]	I	PCIe differential ²	Serial Link		
	PE00RP[3:0]	I				
	PE00TN[3:0]	O				
	PE00TP[3:0]	O				
	PE01RN[3:0]	I				
	PE01RP[3:0]	I				
	PE01TN[3:0]	O				
	PE01TP[3:0]	O				
	PE02RN[3:0]	I				
	PE02RP[3:0]	I				
	PE02TN[3:0]	O				
	PE02TP[3:0]	O				
	PE03RN[3:0]	I				
	PE03RP[3:0]	I				
	PE03TN[3:0]	O				
	PE03TP[3:0]	O				
	PE04RN[3:0]	I				
	PE04RP[3:0]	I				
	PE04TN[3:0]	O				
	PE04TP[3:0]	O				
	PE05RN[3:0]	I				
	PE05RP[3:0]	I				
	PE05TN[3:0]	O				
	PE05TP[3:0]	O				
	PE06RN[3:0]	I				
	PE06RP[3:0]	I				
	PE06TN[3:0]	O				
	PE06TP[3:0]	O				
	PE07RN[3:0]	I				
	PE07RP[3:0]	I				
	PE07TN[3:0]	O				
	PE07TP[3:0]	O				
PE08RN[3:0]	I					
PE08RP[3:0]	I					
PE08TN[3:0]	O					

Table 9 Pin Characteristics (Part 1 of 3)

Function	Pin Name	Type	Buffer	I/O Type	Internal Resistor ¹	Notes	
PCI Express Interface (Cont.)	PE08TP[3:0]	O	PCIe differential	Serial Link			
	PE09RN[3:0]	I					
	PE09RP[3:0]	I					
	PE09TN[3:0]	O					
	PE09TP[3:0]	O					
	PE10RN[3:0]	I					
	PE10RP[3:0]	I					
	PE10TN[3:0]	O					
	PE10TP[3:0]	O					
	PE11RN[3:0]	I					
	PE11RP[3:0]	I					
	PE11TN[3:0]	O					
	PE11TP[3:0]	O					
	GCLKN[1:0]	I			HCSL	Diff. Clock Input	
	GCLKP[1:0]	I					
	P[11:0]CLKN	I					
P[11:0]CLKP	I						
SMBus	MSMBADDR[4:1]	I	LVTTL	Input	pull-down		
	MSMBCLK	I/O		STI ³		pull-up on board	
	MSMBDAT	I/O		STI		pull-up on board	
	SSMBADDR[5,3:1]	I		Input	pull-up		
	SSMBCLK	I/O		STI		pull-up on board	
	SSMBDAT	I/O		STI		pull-up on board	
General Purpose I/O	GPIO[53:0]	I/O	LVTTL	STI, High Drive	pull-up		
System Pins	CLKMODE[1:0]	I	LVTTL	Input	pull-up		
	CLKMODE[2]	I			pull-down		
	GCLKFSEL	I			pull-down		
	MSMBSMODE	I			pull-down		
	P01MERGEN	I			pull-down		
	P23MERGEN	I			pull-down		
	P45MERGEN	I			pull-down		
	P67MERGEN	I			pull-down		
	P89MERGEN	I			pull-down		
	P1011MERGEN	I			pull-down		
	PERSTN	I			STI		
	RSTHALT	I			Input	pull-down	
	SWMODE[3:0]	I	pull-down				

Table 9 Pin Characteristics (Part 2 of 3)

Function	Pin Name	Type	Buffer	I/O Type	Internal Resistor ¹	Notes
EJTAG / JTAG	JTAG_TCK	I	LVTTTL	STI	pull-up	
	JTAG_TDI	I		STI	pull-up	
	JTAG_TDO	O				
	JTAG_TMS	I		STI	pull-up	
	JTAG_TRST_N	I		STI	pull-up	
SerDes Reference Resistors	REFRES00	I/O	Analog			
	REFRES01	I/O				
	REFRES02	I/O				
	REFRES03	I/O				
	REFRES04	I/O				
	REFRES05	I/O				
	REFRES06	I/O				
	REFRES07	I/O				
	REFRES08	I/O				
	REFRES09	I/O				
	REFRES10	I/O				
	REFRES11	I/O				
REFRESPLL	I/O					

Table 9 Pin Characteristics (Part 3 of 3)

¹. Internal resistor values under typical operating conditions are 92K Ω for pull-up and 91K Ω for pull-down.

². All receiver pins set the DC common mode voltage to ground. All transmitters must be AC coupled to the media.

³. Schmitt Trigger Input (STI).

Logic Diagram — PES48H12AG2



Figure 4 PES48H12AG2 Logic Diagram

System Clock Parameters

Values based on systems running at recommended supply voltages and operating temperatures, as shown in Tables 14 and 15.

Parameter	Description	Condition	Min	Typical	Max	Unit
Refclk _{FREQ}	Input reference clock frequency range		100		125 ¹	MHz
T _{C-RISE}	Rising edge rate	Differential	0.6		4	V/ns
T _{C-FALL}	Falling edge rate	Differential	0.6		4	V/ns
V _{IH}	Differential input high voltage	Differential	+150			mV
V _{IL}	Differential input low voltage	Differential			-150	mV
V _{CROSS}	Absolute single-ended crossing point voltage	Single-ended	+250		+550	mV
V _{CROSS-DELTA}	Variation of V _{CROSS} over all rising clock edges	Single-ended			+140	mV
V _{RB}	Ring back voltage margin	Differential	-100		+100	mV
T _{STABLE}	Time before V _{RB} is allowed	Differential	500			ps
T _{PERIOD-AVG}	Average clock period accuracy		-300		2800	ppm
T _{PERIOD-ABS}	Absolute period, including spread-spectrum and jitter		9.847		10.203	ns
T _{CC-JITTER}	Cycle to cycle jitter				150	ps
V _{MAX}	Absolute maximum input voltage				+1.15	V
V _{MIN}	Absolute minimum input voltage		-0.3			V
Duty Cycle	Duty cycle		40		60	%
Rise/Fall Matching	Single ended rising Refclk edge rate versus falling Refclk edge rate			20		%
Z _{C-DC}	Clock source output DC impedance		40		60	Ω

Table 10 Input Clock Requirements

¹ The input clock frequency will be either 100 or 125 MHz depending on signal GCLKFSEL.

AC Timing Characteristics

Parameter	Description	Gen 1			Gen 2			Units
		Min ¹	Typ ¹	Max ¹	Min ¹	Typ ¹	Max ¹	
PCIe Transmit								
UI	Unit Interval	399.88	400	400.12	199.94	200	200.06	ps
T _{TX-EYE}	Minimum Tx Eye Width	0.75			0.75			UI
T _{TX-EYE-MEDIAN-to-MAX-JITTER}	Maximum time between the jitter median and maximum deviation from the median			0.125				UI
T _{TX-RISE} , T _{TX-FALL}	TX Rise/Fall Time: 20% - 80%	0.125			0.15			UI
T _{TX-IDLE-MIN}	Minimum time in idle	20			20			UI

Table 11 PCIe AC Timing Characteristics (Part 1 of 2)

Parameter	Description	Gen 1			Gen 2			Units
		Min ¹	Typ ¹	Max ¹	Min ¹	Typ ¹	Max ¹	
T _{TX-IDLE-SET-TO-IDLE}	Maximum time to transition to a valid Idle after sending an Idle ordered set			8			8	ns
T _{TX-IDLE-TO-DIFF-DATA}	Maximum time to transition from valid idle to diff data			8			8	ns
T _{TX-SKEW}	Transmitter data skew between any 2 lanes			1.3			1.3	ns
T _{MIN-PULSED}	Minimum Instantaneous Lone Pulse Width	NA			0.9			UI
T _{TX-HF-DJ-DD}	Transmitter Deterministic Jitter > 1.5MHz Bandwidth	NA					0.15	UI
T _{RF-MISMATCH}	Rise/Fall Time Differential Mismatch	NA					0.1	UI
PCIe Receive								
UI	Unit Interval	399.88	400	400.12	199.94		200.06	ps
T _{RX-EYE (with jitter)}	Minimum Receiver Eye Width (jitter tolerance)	0.4			0.4			UI
T _{RX-EYE-MEDIUM TO MAX JITTER}	Max time between jitter median & max deviation			0.3				UI
T _{RX-SKEW}	Lane to lane input skew			20			8	ns
T _{RX-HF-RMS}	1.5 — 100 MHz RMS jitter (common clock)	NA					3.4	ps
T _{RX-HF-DJ-DD}	Maximum tolerable DJ by the receiver (common clock)	NA					88	ps
T _{RX-LF-RMS}	10 KHz to 1.5 MHz RMS jitter (common clock)	NA					4.2	ps
T _{RX-MIN-PULSE}	Minimum receiver instantaneous eye width	NA			0.6			UI

Table 11 PCIe AC Timing Characteristics (Part 2 of 2)

¹. Minimum, Typical, and Maximum values meet the requirements under PCI Specification 2.0

Signal	Symbol	Reference Edge	Min	Max	Unit	Timing Diagram Reference
GPIO						
GPIO[53:0] ¹	T _{pw} ²	None	50	—	ns	

Table 12 GPIO AC Timing Characteristics

¹. GPIO signals must meet the setup and hold times if they are synchronous or the minimum pulse width if they are asynchronous.

². The values for this symbol were determined by calculation, not by testing.

Signal	Symbol	Reference Edge	Min	Max	Unit	Timing Diagram Reference
JTAG						
JTAG_TCK	Tper_16a	none	50.0	—	ns	See Figure 5.
	Thigh_16a, Tlow_16a		10.0	25.0	ns	
JTAG_TMS ¹ , JTAG_TDI	Tsu_16b	JTAG_TCK rising	2.4	—	ns	
	Thld_16b		1.0	—	ns	
JTAG_TDO	Tdo_16c	JTAG_TCK falling	—	20	ns	
	Tdz_16c ²		—	20	ns	
JTAG_TRST_N	Tpw_16d ²	none	25.0	—	ns	

Table 13 JTAG AC Timing Characteristics

¹ The JTAG specification, IEEE 1149.1, recommends that JTAG_TMS should be held at 1 while the signal applied at JTAG_TRST_N changes from 0 to 1. Otherwise, a race may occur if JTAG_TRST_N is deasserted (going from low to high) on a rising edge of JTAG_TCK when JTAG_TMS is low, because the TAP controller might go to either the Run-Test/Idle state or stay in the Test-Logic-Reset state.

² The values for this symbol were determined by calculation, not by testing.



Figure 5 JTAG AC Timing Waveform

Recommended Operating Supply Voltages

Symbol	Parameter	Minimum	Typical	Maximum	Unit
V_{DDCORE}	Internal logic supply	0.9	1.0	1.1	V
$V_{DDI/O}$	I/O supply except for SerDes	2.25	2.5	2.75	V
		3.125	3.3	3.465	V
V_{DDPEA}^1	PCI Express Analog Power	0.95	1.0	1.1	V
V_{DDPEHA}^2	PCI Express Analog High Power	2.25	2.5	2.75	V
V_{DDPETA}^1	PCI Express Transmitter Analog Voltage	0.95	1.0	1.1	V
V_{SS}	Common ground	0	0	0	V

Table 14 PES48H12AG2 Operating Voltages

¹ V_{DDPEA} and V_{DDPETA} should have no more than 25mV_{peak-peak} AC power supply noise superimposed on the 1.0V nominal DC value.

² V_{DDPEHA} should have no more than 50mV_{peak-peak} AC power supply noise superimposed on the 2.5V nominal DC value.

Power-Up/Power-Down Sequence

During power supply ramp-up, V_{DDCORE} must remain at least 1.0V below $V_{DDI/O}$ at all times. There are no other power-up sequence requirements for the various operating supply voltages.

The power-down sequence can occur in any order.

Recommended Operating Temperature

Grade	Temperature
Commercial	0°C to +70°C Ambient
Industrial	-40°C to +85°C Ambient

Table 15 PES48H12AG2 Operating Temperatures

Power Consumption

Typical power is measured under the following conditions: 25°C Ambient, 35% total link usage on all ports, typical voltages defined in Table 14 (and also listed below).

Maximum power is measured under the following conditions: 70°C Ambient, 85% total link usage on all ports, maximum voltages defined in Table 14 (and also listed below).

Number of Active Lanes per Port		Core Supply		PCIe Analog Supply		PCIe Analog High Supply		PCIe Transmitter Supply		I/O Supply		Total	
		Typ 1.0V	Max 1.1V	Typ 1.0V	Max 1.1V	Typ 2.5V	Max 2.75V	Typ 1.0V	Max 1.1V	Typ 2.5V	Max 2.75V	Typ Power	Max Power
8/8/8/8/8/8 (Full Swing)	mA	3360	5529	2313	2705	816	825	845	898	24	29		
	Watts	3.36	6.08	2.31	2.98	2.04	2.27	0.85	0.99	0.06	0.08	8.62	12.40
8/8/8/8/8/8 (Half Swing)	mA	3360	5529	1989	2327	816	825	439	467	24	29		
	Watts	3.36	6.08	1.99	2.56	2.04	2.27	0.44	0.51	0.06	0.08	7.89	11.50

Table 16 PES48H12AG2 Power Consumption — 2.5V I/O

Number of Active Lanes per Port		Core Supply		PCIe Analog Supply		PCIe Analog High Supply		PCIe Transmitter Supply		I/O Supply		Total	
		Typ 1.0V	Max 1.1V	Typ 1.0V	Max 1.1V	Typ 2.5V	Max 2.75V	Typ 1.0V	Max 1.1V	Typ 3.3V	Max 3.465V	Typ Power	Max Power
8/8/8/8/8/8 (Full Swing)	mA	3360	5529	2313	2705	816	825	845	898	30	35		
	Watts	3.36	6.08	2.31	2.98	2.04	2.27	0.85	0.99	0.10	0.12	8.66	12.44
8/8/8/8/8/8 (Half Swing)	mA	3360	5529	1989	2327	816	825	439	467	30	35		
	Watts	3.36	6.08	1.99	2.56	2.04	2.27	0.44	0.51	0.10	0.12	7.93	11.54

Table 17 PES48H12AG2 Power Consumption — 3.3V I/O

Note 1: I/O supply of 3.3V is preferred.

Note 2: The above power consumption assumes that all ports are functioning at Gen2 (5.0 GT/S) speeds. Power consumption can be reduced by turning off unused ports through software or through boot EEPROM. Power savings will occur in V_{DD}PEA, V_{DD}PEHA, and V_{DD}PETA. Power savings can be estimated as directly proportional to the number of unused ports, since the power consumption of a turned-off port is close to zero. For example, if 2 ports out of 12 are turned off, then the power savings for each of the above three power rails can be calculated quite simply as 2/12 multiplied by the power consumption indicated in the above table.

Note 3: Using a port in Gen1 mode (2.5GT/S) results in approximately 18% power savings for each power rail: V_{DD}PEA, V_{DD}PEHA, and V_{DD}PETA.

Thermal Considerations

This section describes thermal considerations for the PES48H12AG2 (35mm² FCBGA1156 package). The data in [Table 18](#) below contains information that is relevant to the thermal performance of the PES48H12AG2 switch.

Symbol	Parameter	Value	Units	Conditions
$T_{J(max)}$	Junction Temperature	125	°C	Maximum
$T_{A(max)}$	Ambient Temperature	70	°C	Maximum for commercial-rated products
		85	°C	Maximum for industrial-rated products
$\theta_{JA(effective)}$	Effective Thermal Resistance, Junction-to-Ambient	13.0	°C/W	Zero air flow
		6.8	°C/W	1 m/S air flow
		5.8	°C/W	2 m/S air flow
θ_{JB}	Thermal Resistance, Junction-to-Board	2.5	°C/W	
θ_{JC}	Thermal Resistance, Junction-to-Case	0.15	°C/W	
P	Power Dissipation of the Device	12.44	Watts	Maximum

Table 18 Thermal Specifications for PES48H12AG2, 35x35 mm FCBGA1156 Package

Note: It is important for the reliability of this device in any user environment that the junction temperature not exceed the $T_{J(max)}$ value specified in [Table 18](#). Consequently, the effective junction to ambient thermal resistance (θ_{JA}) for the worst case scenario must be maintained below the value determined by the formula:

$$\theta_{JA} = (T_{J(max)} - T_{A(max)})/P$$

Given that the values of $T_{J(max)}$, $T_{A(max)}$, and P are known, the value of desired θ_{JA} becomes a known entity to the system designer. How to achieve the desired θ_{JA} is left up to the board or system designer, but in general, it can be achieved by adding the effects of θ_{JC} (value provided in [Table 18](#)), thermal resistance of the chosen adhesive (θ_{CS}), that of the heat sink (θ_{SA}), amount of airflow, and properties of the circuit board (number of layers and size of the board). It is strongly recommended that users perform their own thermal analysis for their own board and system design scenarios.

DC Electrical Characteristics

Values based on systems running at recommended supply voltages, as shown in [Table 14](#).

Note: See [Table 9](#), Pin Characteristics, for a complete I/O listing.

I/O Type	Parameter	Description	Gen1			Gen2			Unit	Condi- tions	
			Min ¹	Typ ¹	Max ¹	Min ¹	Typ ¹	Max ¹			
Serial Link	PCIe Transmit										
	$V_{TX-DIFFp-p}$	Differential peak-to-peak output voltage	800		1200	800		1200	mV		
	$V_{TX-DIFFp-p-LOW}$	Low-Drive Differential Peak to Peak Output Voltage	400		1200	400		1200	mV		
	$V_{TX-DE-RATIO-3.5dB}$	De-emphasized differential output voltage	-3		-4	-3.0	-3.5	-4.0	dB		
	$V_{TX-DE-RATIO-6.0dB}$	De-emphasized differential output voltage	NA			-5.5	-6.0	-6.5	dB		
	$V_{TX-DC-CM}$	DC Common mode voltage	0		3.6	0		3.6	V		
	$V_{TX-CM-ACP}$	RMS AC peak common mode output voltage			20				mV		
	$V_{TX-CM-DC-active-idle-delta}$	Abs delta of DC common mode voltage between L0 and idle			100			100	mV		
	$V_{TX-CM-DC-line-delta}$	Abs delta of DC common mode voltage between D+ and D-			25			25	mV		
	$V_{TX-Idle-DiffP}$	Electrical idle diff peak output			20			20	mV		
	$RL_{TX-DIFF}$	Transmitter Differential Return loss	10						10	dB	0.05 - 1.25GHz
									8	dB	1.25 - 2.5GHz
	RL_{TX-CM}	Transmitter Common Mode Return loss	6					6	dB		
	$Z_{TX-DIFF-DC}$	DC Differential TX impedance	80	100	120			120	Ω		
	$V_{TX-CM-ACpp}$	Peak-Peak AC Common	NA					100	mV		
	$V_{TX-DC-CM}$	Transmit Driver DC Common Mode Voltage	0		3.6	0		3.6	V		
$V_{TX-RCV-DETECT}$	The amount of voltage change allowed during Receiver Detection			600			600	mV			
$I_{TX-SHORT}$	Transmitter Short Circuit Current Limit	0		90				90	mA		

Table 19 DC Electrical Characteristics (Part 1 of 2)

I/O Type	Parameter	Description	Gen1			Gen2			Unit	Conditions
			Min ¹	Typ ¹	Max ¹	Min ¹	Typ ¹	Max ¹		
Serial Link (cont.)	PCIe Receive									
	$V_{RX-DIFFp-p}$	Differential input voltage (peak-to-peak)	175		1200	120		1200	mV	
	$RL_{RX-DIFF}$	Receiver Differential Return Loss	10					10	dB	0.05 - 1.25GHz
								8		1.25 - 2.5GHz
	RL_{RX-CM}	Receiver Common Mode Return Loss	6					6	dB	
	$Z_{RX-DIFF-DC}$	Differential input impedance (DC)	80	100	120	Refer to return loss spec			Ω	
	Z_{RX-DC}	DC common mode impedance	40	50	60	40		60	Ω	
	$Z_{RX-COMM-DC}$	Powered down input common mode impedance (DC)	200k	350k				50k	Ω	
	$Z_{RX-HIGH-IMP-DC-POS}$	DC input CM input impedance for $V > 0$ during reset or power down			50k			50k	Ω	
	$Z_{RX-HIGH-IMP-DC-NEG}$	DC input CM input impedance for $V < 0$ during reset or power down			1.0k			1.0k	Ω	
$V_{RX-IDLE-DET-DIFFp-p}$	Electrical idle detect threshold	65		175	65		175	mV		
$V_{RX-CM-ACp}$	Receiver AC common-mode peak voltage			150			150	mV	$V_{RX-CM-ACp}$	
PCIe REFCLK										
	C_{IN}	Input Capacitance	1.5	—		1.5	—		pF	
Other I/Os										
LOW Drive Output	I_{OL}		—	2.5	—	—	2.5	—	mA	$V_{OL} = 0.4v$
	I_{OH}		—	-5.5	—	—	-5.5	—	mA	$V_{OH} = 1.5V$
High Drive Output	I_{OL}		—	12.0	—	—	12.0	—	mA	$V_{OL} = 0.4v$
	I_{OH}		—	-20.0	—	—	-20.0	—	mA	$V_{OH} = 1.5V$
Schmitt Trigger Input (STI)	V_{IL}		-0.3	—	0.8	-0.3	—	0.8	V	—
	V_{IH}		2.0	—	$V_{DD}/O + 0.5$	2.0	—	$V_{DD}/O + 0.5$	V	—
Input	V_{IL}		-0.3	—	0.8	-0.3	—	0.8	V	—
	V_{IH}		2.0	—	$V_{DD}/O + 0.5$	2.0	—	$V_{DD}/O + 0.5$	V	—
Capacitance	C_{IN}		—	—	8.5	—	—	8.5	pF	—
Leakage	Inputs		—	—	± 10	—	—	± 10	μA	V_{DD}/O (max)
	I/O_{LEAK} W/O Pull-ups/downs		—	—	± 10	—	—	± 10	μA	V_{DD}/O (max)
	I/O_{LEAK} WITH Pull-ups/downs		—	—	± 80	—	—	± 80	μA	V_{DD}/O (max)

Table 19 DC Electrical Characteristics (Part 2 of 2)

¹ Minimum, Typical, and Maximum values meet the requirements under PCI Specification 2.0.

Absolute Maximum Voltage Rating

Core Supply	PCIe Analog Supply	PCIe Analog High Supply	PCIe Transmitter Supply	I/O Supply
1.5V	1.5V	4.6V	1.5V	4.6V

Table 20 PES48H12AG2 Absolute Maximum Voltage Rating

Warning: For proper and reliable operation in adherence with this datasheet, the device should not exceed the recommended operating voltages in Table 14. The absolute maximum operating voltages in Table 20 are offered to provide guidelines for voltage excursions outside the recommended voltage ranges. Device functionality is not guaranteed at these conditions and sustained operation at these values or any exposure to voltages outside the maximum range may adversely affect device functionality and reliability.

SMBus Characterization

Symbol	Parameter	SMBus 2.0 Char. Data ¹			Unit
		3V	3.3V	3.6V	
DC Parameter for SDA Pin					
V _{IL}	Input Low	1.16	1.26	1.35	V
V _{IH}	Input High	1.56	1.67	1.78	V
V _{OL@350uA}	Output Low	15	15	15	mV
I _{OL@0.4V}		23	24	25	mA
I _{Pullup}	Current Source	—	—	—	μA
I _{IL_Leak}	Input Low Leakage	0	0	0	μA
I _{IH_Leak}	Input High Leakage	0	0	0	μA
DC Parameter for SCL Pin					
V _{IL (V)}	Input Low	1.11	1.2	1.31	V
V _{IH (V)}	Input High	1.54	1.65	1.76	V
I _{IL_Leak}	Input Low Leakage	0	0	0	μA
I _{IH_Leak}	Input High Leakage	0	0	0	μA

Table 21 SMBus DC Characterization Data

¹ Data at room and hot temperature.

Symbol	Parameter	SMBus @3.3V $\pm 10\%$ ¹		Unit
		Min	Max	
F _{SCL}	Clock frequency	5	600	KHz
T _{BUF}	Bus free time between Stop and Start	3.5	—	μ s
T _{HD:STA}	Start condition hold time	1	—	μ s
T _{SU:STA}	Start condition setup time	1	—	μ s
T _{SU:STO}	Stop condition setup time	1	—	μ s
T _{HD:DAT}	Data hold time	1	—	ns
T _{SU:DAT}	Data setup time	1	—	ns
T _{TIMEOUT}	Detect clock low time out	—	74.7	ms
T _{LOW}	Clock low period	3.7	—	μ s
T _{HIGH}	Clock high period	3.7	—	μ s
T _F	Clock/Data fall time	—	72.2	ns
T _R	Clock/Data rise time	—	68.3	ns
T _{POR@10kHz}	Time which a device must be operational after power-on reset	20	—	ms

Table 22 SMBus AC Timing Data

¹. Data at room and hot temperature.

PES48H12AG2 Package Pinout — 35x35mm1156-BGA Signal Pinout

The following table lists the pin numbers and signal names for the PES48H12AG2 35x35mm device.

Pin	Function	Alt	Pin	Function	Alt	Pin	Function	Alt	Pin	Function	Alt
A1	V _{SS}		B1	V _{SS}		C1	GPIO_29	2	D1	GPIO_28	2
A2	V _{SS}		B2	V _{DD} /O		C2	GPIO_27	2	D2	GPIO_26	2
A3	GPIO_19	1	B3	GPIO_18	1	C3	GPIO_21	1	D3	V _{DD} /O	
A4	V _{DD} /O		B4	GPIO_17	1	C4	GPIO_16	1	D4	GPIO_23	2
A5	V _{SS}		B5	V _{SS}		C5	V _{SS}		D5	V _{SS}	
A6	PE09TP3		B6	PE09TN3		C6	V _{SS}		D6	PE09RN3	
A7	PE09TP2		B7	PE09TN2		C7	V _{SS}		D7	PE09RN2	
A8	V _{SS}		B8	V _{SS}		C8	V _{SS}		D8	V _{SS}	
A9	PE09TP1		B9	PE09TN1		C9	V _{SS}		D9	PE09RN1	
A10	PE09TP0		B10	PE09TN0		C10	V _{SS}		D10	PE09RN0	
A11	V _{SS}		B11	V _{SS}		C11	V _{SS}		D11	V _{SS}	
A12	PE08TP3		B12	PE08TN3		C12	V _{SS}		D12	PE08RN3	
A13	PE08TP2		B13	PE08TN2		C13	V _{SS}		D13	PE08RN2	
A14	V _{SS}		B14	V _{SS}		C14	V _{SS}		D14	V _{SS}	
A15	PE08TP1		B15	PE08TN1		C15	V _{SS}		D15	PE08RN1	
A16	PE08TP0		B16	PE08TN0		C16	V _{SS}		D16	PE08RN0	
A17	V _{SS}		B17	V _{SS}		C17	V _{SS}		D17	V _{SS}	
A18	PE03TP3		B18	PE03TN3		C18	V _{SS}		D18	PE03RN3	
A19	PE03TP2		B19	PE03TN2		C19	V _{SS}		D19	PE03RN2	
A20	V _{SS}		B20	V _{SS}		C20	V _{SS}		D20	V _{SS}	
A21	PE03TP1		B21	PE03TN1		C21	V _{SS}		D21	PE03RN1	
A22	PE03TP0		B22	PE03TN0		C22	V _{SS}		D22	PE03RN0	
A23	V _{SS}		B23	V _{SS}		C23	V _{SS}		D23	V _{SS}	
A24	PE02TP3		B24	PE02TN3		C24	V _{SS}		D24	PE02RN3	
A25	PE02TP2		B25	PE02TN2		C25	V _{SS}		D25	PE02RN2	
A26	V _{SS}		B26	V _{SS}		C26	V _{SS}		D26	V _{SS}	
A27	PE02TP1		B27	PE02TN1		C27	V _{SS}		D27	PE02RN1	
A28	PE02TP0		B28	PE02TN0		C28	V _{SS}		D28	PE02RN0	
A29	V _{SS}		B29	V _{SS}		C29	V _{SS}		D29	V _{SS}	
A30	V _{DD} /O		B30	MSMBADDR3		C30	MSMBADDR4		D30	JTAG_TMS	
A31	MSMBADDR1		B31	MSMBADDR2		C31	JTAG_TDI		D31	V _{DD} /O	
A32	MSMBSMODE		B32	PERSTN		C32	JTAG_TRST_N		D32	SSMBADDR5	
A33	V _{SS}		B33	V _{DD} /O		C33	SSMBADDR2		D33	SSMBADDR3	
A34	V _{SS}		B34	V _{SS}		C34	SSMBADDR1		D34	V _{DD} /O	

Table 23 PES48H12AG2 1156-pin Signal Pin-Out (Part 1 of 9)

Pin	Function	Alt	Pin	Function	Alt	Pin	Function	Alt	Pin	Function	Alt
E1	V _{DD} I/O		F1	V _{SS}		G1	PE10TP0		H1	PE10TP1	
E2	GPIO_30	2	F2	V _{SS}		G2	PE10TN0		H2	PE10TN1	
E3	GPIO_31	2	F3	V _{SS}		G3	V _{SS}		H3	V _{SS}	
E4	GPIO_24	2	F4	V _{SS}		G4	PE10RN0		H4	PE10RN1	
E5	V _{SS}		F5	V _{SS}		G5	PE10RP0		H5	PE10RP1	
E6	PE09RP3		F6	V _{SS}		G6	V _{SS}		H6	V _{SS}	
E7	PE09RP2		F7	V _{SS}		G7	GPIO_46	1	H7	GPIO_48	1
E8	V _{SS}		F8	V _{SS}		G8	GPIO_45	1	H8	GPIO_20	1
E9	PE09RP1		F9	V _{SS}		G9	V _{SS}		H9	V _{DD} I/O	
E10	PE09RP0		F10	REFRES09		G10	V _{SS}		H10	GPIO_47	1
E11	V _{SS}		F11	P09CLKP		G11	P09CLKN		H11	V _{SS}	
E12	PE08RP3		F12	V _{SS}		G12	NC		H12	V _{SS}	
E13	PE08RP2		F13	V _{SS}		G13	V _{SS}		H13	V _{DD} PEHA	
E14	V _{SS}		F14	P08CLKP		G14	P08CLKN		H14	V _{SS}	
E15	PE08RP1		F15	V _{SS}		G15	NC		H15	V _{DD} PETA	
E16	PE08RP0		F16	V _{SS}		G16	V _{SS}		H16	V _{SS}	
E17	V _{SS}		F17	REFRESPLL		G17	GCLKN0		H17	V _{SS}	
E18	PE03RP3		F18	V _{SS}		G18	GCLKP0		H18	V _{SS}	
E19	PE03RP2		F19	REFRES03		G19	NC		H19	V _{SS}	
E20	V _{SS}		F20	P03CLKP		G20	P03CLKN		H20	V _{DD} PETA	
E21	PE03RP1		F21	V _{SS}		G21	V _{SS}		H21	REFRES02	
E22	PE03RP0		F22	V _{SS}		G22	NC		H22	V _{DD} PEHA	
E23	V _{SS}		F23	P02CLKP		G23	P02CLKN		H23	V _{SS}	
E24	PE02RP3		F24	V _{SS}		G24	V _{SS}		H24	V _{SS}	
E25	PE02RP2		F25	V _{SS}		G25	V _{SS}		H25	V _{SS}	
E26	V _{SS}		F26	V _{SS}		G26	GPIO_33	2	H26	MSMBDAT	
E27	PE02RP1		F27	V _{SS}		G27	MSMBCLK		H27	V _{DD} I/O	
E28	PE02RP0		F28	V _{SS}		G28	GPIO_32	2	H28	SSMBCLK	
E29	V _{SS}		F29	V _{SS}		G29	V _{SS}		H29	V _{SS}	
E30	V _{SS}		F30	PE01RP3		G30	PE01RP2		H30	V _{SS}	
E31	V _{SS}		F31	PE01RN3		G31	PE01RN2		H31	V _{SS}	
E32	V _{SS}		F32	V _{SS}		G32	V _{SS}		H32	V _{SS}	
E33	V _{SS}		F33	PE01TN3		G33	PE01TN2		H33	V _{SS}	
E34	V _{SS}		F34	PE01TP3		G34	PE01TP2		H34	V _{SS}	

Table 23 PES48H12AG2 1156-pin Signal Pin-Out (Part 2 of 9)

Pin	Function	Alt	Pin	Function	Alt	Pin	Function	Alt	Pin	Function	Alt
J1	V _{SS}		K1	PE10TP2		L1	PE10TP3		M1	V _{SS}	
J2	V _{SS}		K2	PE10TN2		L2	PE10TN3		M2	V _{SS}	
J3	V _{SS}		K3	V _{SS}		L3	V _{SS}		M3	V _{SS}	
J4	V _{SS}		K4	PE10RN2		L4	PE10RN3		M4	V _{SS}	
J5	V _{SS}		K5	PE10RP2		L5	PE10RP3		M5	V _{SS}	
J6	GPIO_50	1	K6	V _{SS}		L6	V _{SS}		M6	V _{SS}	
J7	GPIO_51	1	K7	GPIO_53	1	L7	V _{SS}		M7	V _{SS}	
J8	V _{SS}		K8	GPIO_52	1	L8	V _{SS}		M8	V _{SS}	
J9	GPIO_25	2	K9	V _{DD} /I/O		L9	V _{SS}		M9	V _{SS}	
J10	GPIO_49	1	K10	GPIO_22	2	L10	V _{SS}		M10	V _{SS}	
J11	V _{SS}		K11	V _{SS}		L11	V _{SS}		M11	V _{SS}	
J12	V _{SS}		K12	V _{SS}		L12	V _{SS}		M12	V _{SS}	
J13	V _{SS}		K13	V _{DD} PEHA		L13	V _{DD} PEA		M13	V _{DD} PEA	
J14	V _{DD} PEA		K14	V _{SS}		L14	V _{DD} PEA		M14	V _{SS}	
J15	REFRES08		K15	V _{DD} PETA		L15	V _{DD} PEA		M15	V _{DD} PEA	
J16	V _{SS}		K16	V _{SS}		L16	V _{SS}		M16	V _{SS}	
J17	V _{DD} PEHA		K17	V _{DD} PEHA		L17	V _{DD} PEA		M17	V _{DD} PEA	
J18	V _{DD} PEHA		K18	V _{DD} PEHA		L18	V _{DD} PEA		M18	V _{DD} PEA	
J19	V _{SS}		K19	V _{SS}		L19	V _{SS}		M19	V _{SS}	
J20	V _{SS}		K20	V _{DD} PETA		L20	V _{DD} PEA		M20	V _{DD} PEA	
J21	V _{DD} PEA		K21	V _{SS}		L21	V _{DD} PEA		M21	V _{SS}	
J22	V _{SS}		K22	V _{DD} PEHA		L22	V _{DD} PEA		M22	V _{DD} PEA	
J23	V _{SS}		K23	V _{SS}		L23	V _{SS}		M23	V _{SS}	
J24	V _{SS}		K24	V _{SS}		L24	V _{SS}		M24	V _{SS}	
J25	JTAG_TDO		K25	CLKMODE1		L25	V _{SS}		M25	V _{SS}	
J26	V _{DD} /I/O		K26	JTAG_TCK		L26	V _{SS}		M26	V _{SS}	
J27	SSMBDAT		K27	GPIO_36	2	L27	V _{SS}		M27	V _{SS}	
J28	GPIO_34	2	K28	GPIO_35	2	L28	V _{SS}		M28	REFRES01	
J29	V _{SS}		K29	V _{SS}		L29	V _{SS}		M29	V _{SS}	
J30	PE01RP1		K30	PE01RP0		L30	V _{SS}		M30	PE00RP3	
J31	PE01RN1		K31	PE01RN0		L31	V _{SS}		M31	PE00RN3	
J32	V _{SS}		K32	V _{SS}		L32	V _{SS}		M32	V _{SS}	
J33	PE01TN1		K33	PE01TN0		L33	V _{SS}		M33	PE00TN3	
J34	PE01TP1		K34	PE01TP0		L34	V _{SS}		M34	PE00TP3	

Table 23 PES48H12AG2 1156-pin Signal Pin-Out (Part 3 of 9)

Pin	Function	Alt	Pin	Function	Alt	Pin	Function	Alt	Pin	Function	Alt
N1	PE11TP0		P1	PE11TP1		R1	V _{SS}		T1	PE11TP2	
N2	PE11TN0		P2	PE11TN1		R2	V _{SS}		T2	PE11TN2	
N3	V _{SS}		P3	V _{SS}		R3	V _{SS}		T3	V _{SS}	
N4	PE11RN0		P4	PE11RN1		R4	V _{SS}		T4	PE11RN2	
N5	PE11RP0		P5	PE11RP1		R5	V _{SS}		T5	PE11RP2	
N6	V _{SS}		P6	V _{SS}		R6	V _{SS}		T6	NC	
N7	NC		P7	P10CLKP		R7	REFRES10		T7	P11CLKP	
N8	V _{DD} PEHA		P8	P10CLKN		R8	V _{DD} PETA		T8	P11CLKN	
N9	V _{SS}		P9	V _{DD} PEA		R9	V _{SS}		T9	REFRES11	
N10	V _{DD} PEHA		P10	V _{SS}		R10	V _{DD} PETA		T10	V _{SS}	
N11	V _{DD} PEA		P11	V _{DD} PEA		R11	V _{DD} PEA		T11	V _{SS}	
N12	V _{DD} PEA		P12	V _{SS}		R12	V _{DD} PEA		T12	V _{SS}	
N13	V _{DD} CORE		P13	V _{DD} CORE		R13	V _{DD} CORE		T13	V _{SS}	
N14	V _{DD} CORE		P14	V _{SS}		R14	V _{DD} CORE		T14	V _{SS}	
N15	V _{DD} CORE		P15	V _{DD} CORE		R15	V _{SS}		T15	V _{DD} CORE	
N16	V _{SS}		P16	V _{SS}		R16	V _{DD} CORE		T16	V _{SS}	
N17	V _{DD} CORE		P17	V _{DD} CORE		R17	V _{SS}		T17	V _{DD} CORE	
N18	V _{SS}		P18	V _{SS}		R18	V _{DD} CORE		T18	V _{SS}	
N19	V _{DD} CORE		P19	V _{DD} CORE		R19	V _{SS}		T19	V _{DD} CORE	
N20	V _{DD} CORE		P20	V _{SS}		R20	V _{DD} CORE		T20	V _{SS}	
N21	V _{DD} CORE		P21	V _{DD} CORE		R21	V _{SS}		T21	V _{DD} CORE	
N22	V _{DD} CORE		P22	V _{DD} CORE		R22	V _{DD} CORE		T22	V _{DD} CORE	
N23	V _{DD} PEA		P23	V _{SS}		R23	V _{DD} PEA		T23	V _{SS}	
N24	V _{DD} PEA		P24	V _{DD} PEA		R24	V _{DD} PEA		T24	V _{SS}	
N25	V _{DD} PEHA		P25	V _{SS}		R25	V _{DD} PETA		T25	V _{SS}	
N26	V _{SS}		P26	V _{DD} PEA		R26	V _{SS}		T26	V _{SS}	
N27	V _{DD} PEHA		P27	P01CLKN		R27	V _{DD} PETA		T27	P00CLKN	
N28	NC		P28	P01CLKP		R28	V _{SS}		T28	P00CLKP	
N29	V _{SS}		P29	V _{SS}		R29	REFRES00		T29	NC	
N30	PE00RP2		P30	V _{SS}		R30	PE00RP1		T30	PE00RP0	
N31	PE00RN2		P31	V _{SS}		R31	PE00RN1		T31	PE00RN0	
N32	V _{SS}		P32	V _{SS}		R32	V _{SS}		T32	V _{SS}	
N33	PE00TN2		P33	V _{SS}		R33	PE00TN1		T33	PE00TN0	
N34	PE00TP2		P34	V _{SS}		R34	PE00TP1		T34	PE00TP0	

Table 23 PES48H12AG2 1156-pin Signal Pin-Out (Part 4 of 9)

Pin	Function	Alt	Pin	Function	Alt	Pin	Function	Alt	Pin	Function	Alt
U1	PE11TP3		V1	V _{SS}		W1	PE04TP0		Y1	PE04TP1	
U2	PE11TN3		V2	V _{SS}		W2	PE04TN0		Y2	PE04TN1	
U3	V _{SS}		V3	V _{SS}		W3	V _{SS}		Y3	V _{SS}	
U4	PE11RN3		V4	V _{SS}		W4	PE04RN0		Y4	PE04RN1	
U5	PE11RP3		V5	V _{SS}		W5	PE04RP0		Y5	PE04RP1	
U6	V _{SS}		V6	V _{SS}		W6	V _{SS}		Y6	NC	
U7	NC		V7	NC		W7	P04CLKP		Y7	REFRES04	
U8	V _{SS}		V8	V _{SS}		W8	P04CLKN		Y8	V _{DD} PETA	
U9	V _{DD} PEHA		V9	V _{DD} PEHA		W9	V _{SS}		Y9	V _{SS}	
U10	V _{DD} PEHA		V10	V _{DD} PEHA		W10	V _{SS}		Y10	V _{DD} PETA	
U11	V _{DD} PEA		V11	V _{DD} PEA		W11	V _{SS}		Y11	V _{DD} PEA	
U12	V _{DD} PEA		V12	V _{DD} PEA		W12	V _{SS}		Y12	V _{DD} PEA	
U13	V _{DD} CORE		V13	V _{SS}		W13	V _{DD} CORE		Y13	V _{DD} CORE	
U14	V _{DD} CORE		V14	V _{SS}		W14	V _{DD} CORE		Y14	V _{SS}	
U15	V _{SS}		V15	V _{DD} CORE		W15	V _{SS}		Y15	V _{DD} CORE	
U16	V _{DD} CORE		V16	V _{SS}		W16	V _{DD} CORE		Y16	V _{SS}	
U17	V _{SS}		V17	V _{DD} CORE		W17	V _{SS}		Y17	V _{DD} CORE	
U18	V _{DD} CORE		V18	V _{SS}		W18	V _{DD} CORE		Y18	V _{SS}	
U19	V _{SS}		V19	V _{DD} CORE		W19	V _{SS}		Y19	V _{DD} CORE	
U20	V _{DD} CORE		V20	V _{SS}		W20	V _{DD} CORE		Y20	V _{SS}	
U21	V _{SS}		V21	V _{DD} CORE		W21	V _{SS}		Y21	V _{DD} CORE	
U22	V _{SS}		V22	V _{DD} CORE		W22	V _{SS}		Y22	V _{DD} CORE	
U23	V _{DD} PEA		V23	V _{DD} PEA		W23	V _{SS}		Y23	V _{DD} PEA	
U24	V _{DD} PEA		V24	V _{DD} PEA		W24	V _{SS}		Y24	V _{DD} PEA	
U25	V _{DD} PEHA		V25	V _{DD} PEHA		W25	V _{SS}		Y25	V _{DD} PETA	
U26	V _{DD} PEHA		V26	V _{DD} PEHA		W26	NC		Y26	V _{SS}	
U27	V _{SS}		V27	V _{SS}		W27	V _{SS}		Y27	V _{DD} PETA	
U28	NC		V28	NC		W28	V _{SS}		Y28	V _{SS}	
U29	V _{SS}		V29	V _{SS}		W29	V _{SS}		Y29	NC	
U30	V _{SS}		V30	NC		W30	NC		Y30	V _{SS}	
U31	V _{SS}		V31	NC		W31	NC		Y31	V _{SS}	
U32	V _{SS}		V32	V _{SS}		W32	V _{SS}		Y32	V _{SS}	
U33	V _{SS}		V33	NC		W33	NC		Y33	V _{SS}	
U34	V _{SS}		V34	NC		W34	NC		Y34	V _{SS}	

Table 23 PES48H12AG2 1156-pin Signal Pin-Out (Part 5 of 9)

Pin	Function	Alt	Pin	Function	Alt	Pin	Function	Alt	Pin	Function	Alt
AA1	V _{SS}		AB1	PE04TP2		AC1	PE04TP3		AD1	V _{SS}	
AA2	V _{SS}		AB2	PE04TN2		AC2	PE04TN3		AD2	V _{SS}	
AA3	V _{SS}		AB3	V _{SS}		AC3	V _{SS}		AD3	V _{SS}	
AA4	V _{SS}		AB4	PE04RN2		AC4	PE04RN3		AD4	V _{SS}	
AA5	V _{SS}		AB5	PE04RP2		AC5	PE04RP3		AD5	V _{SS}	
AA6	V _{SS}		AB6	REFRES05		AC6	V _{SS}		AD6	V _{SS}	
AA7	P05CLKP		AB7	NC		AC7	V _{SS}		AD7	V _{SS}	
AA8	P05CLKN		AB8	V _{DD} PEHA		AC8	V _{SS}		AD8	V _{SS}	
AA9	V _{DD} PEA		AB9	V _{SS}		AC9	V _{SS}		AD9	NC	
AA10	V _{SS}		AB10	V _{DD} PEHA		AC10	V _{SS}		AD10	NC	
AA11	V _{DD} PEA		AB11	V _{DD} PEA		AC11	V _{SS}		AD11	V _{SS}	
AA12	V _{SS}		AB12	V _{DD} PEA		AC12	V _{SS}		AD12	V _{SS}	
AA13	V _{DD} CORE		AB13	V _{DD} CORE		AC13	V _{DD} PEA		AD13	V _{DD} PEA	
AA14	V _{DD} CORE		AB14	V _{DD} CORE		AC14	V _{SS}		AD14	V _{DD} PEA	
AA15	V _{SS}		AB15	V _{DD} CORE		AC15	V _{DD} PEA		AD15	V _{DD} PEA	
AA16	V _{DD} CORE		AB16	V _{DD} CORE		AC16	V _{SS}		AD16	V _{SS}	
AA17	V _{SS}		AB17	V _{SS}		AC17	V _{DD} PEA		AD17	V _{DD} PEA	
AA18	V _{DD} CORE		AB18	V _{DD} CORE		AC18	V _{DD} PEA		AD18	V _{DD} PEA	
AA19	V _{SS}		AB19	V _{SS}		AC19	V _{SS}		AD19	V _{SS}	
AA20	V _{DD} CORE		AB20	V _{DD} CORE		AC20	V _{DD} PEA		AD20	V _{DD} PEA	
AA21	V _{SS}		AB21	V _{DD} CORE		AC21	V _{SS}		AD21	V _{DD} PEA	
AA22	V _{DD} CORE		AB22	V _{DD} CORE		AC22	V _{DD} PEA		AD22	V _{DD} PEA	
AA23	V _{SS}		AB23	V _{DD} PEA		AC23	V _{SS}		AD23	V _{SS}	
AA24	V _{DD} PEA		AB24	V _{DD} PEA		AC24	V _{SS}		AD24	V _{SS}	
AA25	V _{SS}		AB25	V _{DD} PEHA		AC25	V _{SS}		AD25	GPIO_39	2
AA26	V _{DD} PEA		AB26	V _{SS}		AC26	V _{SS}		AD26	GPIO_38	2
AA27	V _{SS}		AB27	V _{DD} PEHA		AC27	V _{SS}		AD27	GPIO_37	2
AA28	V _{SS}		AB28	V _{SS}		AC28	V _{SS}		AD28	V _{SS}	
AA29	V _{SS}		AB29	V _{SS}		AC29	V _{SS}		AD29	V _{SS}	
AA30	NC		AB30	NC		AC30	V _{SS}		AD30	NC	
AA31	NC		AB31	NC		AC31	V _{SS}		AD31	NC	
AA32	V _{SS}		AB32	V _{SS}		AC32	V _{SS}		AD32	V _{SS}	
AA33	NC		AB33	NC		AC33	V _{SS}		AD33	NC	
AA34	NC		AB34	NC		AC34	V _{SS}		AD34	NC	

Table 23 PES48H12AG2 1156-pin Signal Pin-Out (Part 6 of 9)

Pin	Function	Alt	Pin	Function	Alt	Pin	Function	Alt	Pin	Function	Alt
AE1	PE05TP0		AF1	PE05TP1		AG1	V _{SS}		AH1	PE05TP2	
AE2	PE05TN0		AF2	PE05TN1		AG2	V _{SS}		AH2	PE05TN2	
AE3	V _{SS}		AF3	V _{SS}		AG3	V _{SS}		AH3	V _{SS}	
AE4	PE05RN0		AF4	PE05RN1		AG4	V _{SS}		AH4	PE05RN2	
AE5	PE05RP0		AF5	PE05RP1		AG5	V _{SS}		AH5	PE05RP2	
AE6	V _{SS}		AF6	V _{SS}		AG6	V _{SS}		AH6	V _{SS}	
AE7	V _{SS}		AF7	V _{SS}		AG7	CLKMODE0		AH7	CLKMODE2	
AE8	V _{DD} I/O		AF8	V _{SS}		AG8	V _{DD} I/O		AH8	GCLKFSEL	
AE9	V _{DD} I/O		AF9	V _{DD} I/O		AG9	V _{DD} I/O		AH9	V _{SS}	
AE10	V _{SS}		AF10	V _{DD} I/O		AG10	V _{SS}		AH10	V _{SS}	
AE11	V _{SS}		AF11	V _{SS}		AG11	V _{SS}		AH11	V _{SS}	
AE12	V _{SS}		AF12	V _{SS}		AG12	V _{SS}		AH12	P06CLKN	
AE13	V _{DD} PEHA		AF13	V _{SS}		AG13	V _{DD} PEHA		AH13	V _{SS}	
AE14	V _{SS}		AF14	V _{DD} PEA		AG14	V _{SS}		AH14	REFRES06	
AE15	V _{DD} PETA		AF15	V _{SS}		AG15	V _{DD} PETA		AH15	P07CLKN	
AE16	V _{SS}		AF16	V _{SS}		AG16	V _{SS}		AH16	NC	
AE17	V _{DD} PEHA		AF17	V _{DD} PEHA		AG17	V _{SS}		AH17	GCLKP1	
AE18	V _{DD} PEHA		AF18	V _{DD} PEHA		AG18	V _{SS}		AH18	GCLKN1	
AE19	V _{SS}		AF19	V _{SS}		AG19	V _{SS}		AH19	V _{SS}	
AE20	V _{DD} PETA		AF20	V _{SS}		AG20	V _{DD} PETA		AH20	V _{SS}	
AE21	V _{SS}		AF21	V _{DD} PEA		AG21	NC		AH21	V _{SS}	
AE22	V _{DD} PEHA		AF22	V _{SS}		AG22	V _{DD} PEHA		AH22	NC	
AE23	V _{SS}		AF23	V _{SS}		AG23	V _{SS}		AH23	V _{SS}	
AE24	V _{SS}		AF24	V _{SS}		AG24	V _{SS}		AH24	V _{SS}	
AE25	GPIO_06		AF25	GPIO_42	2	AG25	GPIO_44	1	AH25	V _{SS}	
AE26	V _{DD} I/O		AF26	GPIO_09	1	AG26	V _{DD} I/O		AH26	V _{SS}	
AE27	GPIO_40	2	AF27	GPIO_41	2	AG27	GPIO_04	1	AH27	V _{SS}	
AE28	V _{SS}		AF28	V _{SS}		AG28	GPIO_43	2	AH28	V _{SS}	
AE29	V _{SS}		AF29	V _{SS}		AG29	V _{SS}		AH29	V _{SS}	
AE30	NC		AF30	V _{SS}		AG30	NC		AH30	NC	
AE31	NC		AF31	V _{SS}		AG31	NC		AH31	NC	
AE32	V _{SS}		AF32	V _{SS}		AG32	V _{SS}		AH32	V _{SS}	
AE33	NC		AF33	V _{SS}		AG33	NC		AH33	NC	
AE34	NC		AF34	V _{SS}		AG34	NC		AH34	NC	

Table 23 PES48H12AG2 1156-pin Signal Pin-Out (Part 7 of 9)

Pin	Function	Alt	Pin	Function	Alt	Pin	Function	Alt	Pin	Function	Alt
AJ1	PE05TP3		AK1	V _{SS}		AL1	V _{DD} I/O		AM1	P23MERGEN	
AJ2	PE05TN3		AK2	V _{SS}		AL2	P01MERGEN		AM2	P67MERGEN	
AJ3	V _{SS}		AK3	V _{SS}		AL3	P45MERGEN		AM3	V _{DD} I/O	
AJ4	PE05RN3		AK4	V _{SS}		AL4	V _{DD} I/O		AM4	P1011MERGEN	
AJ5	PE05RP3		AK5	V _{SS}		AL5	P89MERGEN		AM5	SWMODE3	
AJ6	V _{SS}		AK6	V _{SS}		AL6	V _{SS}		AM6	V _{SS}	
AJ7	V _{SS}		AK7	PE06RP0		AL7	PE06RN0		AM7	V _{SS}	
AJ8	V _{SS}		AK8	PE06RP1		AL8	PE06RN1		AM8	V _{SS}	
AJ9	V _{SS}		AK9	V _{SS}		AL9	V _{SS}		AM9	V _{SS}	
AJ10	V _{SS}		AK10	PE06RP2		AL10	PE06RN2		AM10	V _{SS}	
AJ11	V _{SS}		AK11	PE06RP3		AL11	PE06RN3		AM11	V _{SS}	
AJ12	P06CLKP		AK12	V _{SS}		AL12	V _{SS}		AM12	V _{SS}	
AJ13	V _{SS}		AK13	PE07RP0		AL13	PE07RN0		AM13	V _{SS}	
AJ14	NC		AK14	PE07RP1		AL14	PE07RN1		AM14	V _{SS}	
AJ15	P07CLKP		AK15	V _{SS}		AL15	V _{SS}		AM15	V _{SS}	
AJ16	REFRES07		AK16	PE07RP2		AL16	PE07RN2		AM16	V _{SS}	
AJ17	V _{SS}		AK17	PE07RP3		AL17	PE07RN3		AM17	V _{SS}	
AJ18	V _{SS}		AK18	V _{SS}		AL18	V _{SS}		AM18	V _{SS}	
AJ19	V _{SS}		AK19	NC		AL19	NC		AM19	V _{SS}	
AJ20	V _{SS}		AK20	NC		AL20	NC		AM20	V _{SS}	
AJ21	V _{SS}		AK21	V _{SS}		AL21	V _{SS}		AM21	V _{SS}	
AJ22	V _{SS}		AK22	NC		AL22	NC		AM22	V _{SS}	
AJ23	V _{SS}		AK23	NC		AL23	NC		AM23	V _{SS}	
AJ24	V _{SS}		AK24	V _{SS}		AL24	V _{SS}		AM24	V _{SS}	
AJ25	V _{SS}		AK25	NC		AL25	NC		AM25	V _{SS}	
AJ26	V _{SS}		AK26	NC		AL26	NC		AM26	V _{SS}	
AJ27	V _{SS}		AK27	V _{SS}		AL27	V _{SS}		AM27	V _{SS}	
AJ28	V _{SS}		AK28	NC		AL28	NC		AM28	V _{SS}	
AJ29	V _{SS}		AK29	NC		AL29	NC		AM29	V _{SS}	
AJ30	V _{SS}		AK30	V _{SS}		AL30	V _{SS}		AM30	V _{SS}	
AJ31	V _{SS}		AK31	GPIO_08	1	AL31	GPIO_07		AM31	GPIO_00	1
AJ32	V _{SS}		AK32	GPIO_15	1	AL32	V _{DD} I/O		AM32	GPIO_05	2
AJ33	V _{SS}		AK33	GPIO_14	1	AL33	GPIO_10	1	AM33	GPIO_11	1
AJ34	V _{SS}		AK34	V _{DD} I/O		AL34	GPIO_12	1	AM34	GPIO_13	1

Table 23 PES48H12AG2 1156-pin Signal Pin-Out (Part 8 of 9)

Pin	Function	Alt	Pin	Function	Alt	Pin	Function	Alt	Pin	Function	Alt
AN1	V _{SS}		AN18	V _{SS}		AP1	V _{SS}		AP18	V _{SS}	
AN2	V _{DD} /I/O		AN19	NC		AP2	V _{SS}		AP19	NC	
AN3	V _{DD} /I/O		AN20	NC		AP3	RSTHALT		AP20	NC	
AN4	SWMODE0		AN21	V _{SS}		AP4	SWMODE1		AP21	V _{SS}	
AN5	SWMODE2		AN22	NC		AP5	V _{DD} /I/O		AP22	NC	
AN6	V _{SS}		AN23	NC		AP6	V _{SS}		AP23	NC	
AN7	PE06TN0		AN24	V _{SS}		AP7	PE06TP0		AP24	V _{SS}	
AN8	PE06TN1		AN25	NC		AP8	PE06TP1		AP25	NC	
AN9	V _{SS}		AN26	NC		AP9	V _{SS}		AP26	NC	
AN10	PE06TN2		AN27	V _{SS}		AP10	PE06TP2		AP27	V _{SS}	
AN11	PE06TN3		AN28	NC		AP11	PE06TP3		AP28	NC	
AN12	V _{SS}		AN29	NC		AP12	V _{SS}		AP29	NC	
AN13	PE07TN0		AN30	V _{SS}		AP13	PE07TP0		AP30	V _{SS}	
AN14	PE07TN1		AN31	GPIO_01	1	AP14	PE07TP1		AP31	V _{DD} /I/O	
AN15	V _{SS}		AN32	GPIO_02	1	AP15	V _{SS}		AP32	GPIO_03	1
AN16	PE07TN2		AN33	V _{DD} /I/O		AP16	PE07TP2		AP33	V _{SS}	
AN17	PE07TN3		AN34	V _{SS}		AP17	PE07TP3		AP34	V _{SS}	

Table 23 PES48H12AG2 1156-pin Signal Pin-Out (Part 9 of 9)

Alternate Signal Functions

Pin	GPIO	1st Alternate	2nd Alternate	Pin	GPIO	1st Alternate	2nd Alternate
AM31	GPIO_00	PART0PERSTN	—	D1	GPIO_28	HP2PDN	P4LINKUPN
AN31	GPIO_01	PART1PERSTN	—	C1	GPIO_29	HP2PFN	P4ACTIVEN
AN32	GPIO_02	PART2PERSTN	—	E2	GPIO_30	HP2PWRGDN	P5LINKUPN
AP32	GPIO_03	PART3PERSTN	—	E3	GPIO_31	HP2MRLN	P5ACTIVEN
AG27	GPIO_04	—	P0LINKUPN	G28	GPIO_32	HP2AIN	P6LINKUPN
AM32	GPIO_05	GPEN	P0ACTIVEN	G26	GPIO_33	HP2PIN	P6ACTIVEN
AK31	GPIO_08	IOEXPINTN	—	J28	GPIO_34	HP2PEP	P7LINKUPN
AF26	GPIO_09	HP0APN	—	K28	GPIO_35	HP2RSTN	P7ACTIVEN
AL33	GPIO_10	HP0PDN	—	K27	GPIO_36	HP3APN	P8LINKUPN
AM33	GPIO_11	HP0PFN	—	AD27	GPIO_37	HP3PDN	P8ACTIVEN
AL34	GPIO_12	HP0PWRGDN	—	AD26	GPIO_38	HP3PFN	P9LINKUPN
AM34	GPIO_13	HP0MRLN	—	AD25	GPIO_39	HP3PWRGDN	P9ACTIVEN
AK33	GPIO_14	HP0AIN	—	AE27	GPIO_40	HP3MRLN	P10LINKUPN
AK32	GPIO_15	HP0PIN	—	AF27	GPIO_41	HP3AIN	P10ACTIVEN
C4	GPIO_16	HP0PEP	—	AF25	GPIO_42	HP3PIN	P11LINKUPN
B4	GPIO_17	HP0RSTN	—	AG28	GPIO_43	HP3PEP	P11ACTIVEN
B3	GPIO_18	HP1APN	—	AG25	GPIO_44	HP3RSTN	—
A3	GPIO_19	HP1PDN	—	G8	GPIO_45	HP4APN	—
H8	GPIO_20	HP1PFN	—	G7	GPIO_46	HP4PDN	—
C3	GPIO_21	HP1PWRGDN	—	H10	GPIO_47	HP4PFN	—
K10	GPIO_22	HP1MRLN	P1LINKUPN	H7	GPIO_48	HP4PWRGDN	—
D4	GPIO_23	HP1AIN	P1ACTIVEN	J10	GPIO_49	HP4MRLN	—
E4	GPIO_24	HP1PIN	P2LINKUPN	J6	GPIO_50	HP4AIN	—
J9	GPIO_25	HP1PEP	P2ACTIVEN	J7	GPIO_51	HP4PIN	—
D2	GPIO_26	HP1RSTN	P3LINKUPN	K8	GPIO_52	HP4PEP	—
C2	GPIO_27	HP2APN	P3ACTIVEN	K7	GPIO_53	HP4RSTN	—

Table 24 PES48H12AG2 Alternate Signal Functions

Power Pins

V _{DD} Core	V _{DD} Core	V _{DD} I/O	V _{DD} PEA	V _{DD} PEA	V _{DD} PEHA	V _{DD} PETA
N13	V19	A4	J14	V11	H13	H15
N14	V21	A30	J21	V12	H22	H20
N15	V22	B2	L13	V23	J17	K15
N17	W13	B33	L14	V24	J18	K20
N19	W14	D3	L15	Y11	K13	R8
N20	W16	D31	L17	Y12	K17	R10
N21	W18	D34	L18	Y23	K18	R25
N22	W20	E1	L20	Y24	K22	R27
P13	Y13	H9	L21	AA9	N8	Y8
P15	Y15	H27	L22	AA11	N10	Y10
P17	Y17	J26	M13	AA24	N25	Y25
P19	Y19	K9	M15	AA26	N27	Y27
P21	Y21	AE8	M17	AB11	U9	AE15
P22	Y22	AE9	M18	AB12	U10	AE20
R13	AA13	AE26	M20	AB23	U25	AG15
R14	AA14	AF9	M22	AB24	U26	AG20
R16	AA16	AF10	N11	AC13	V9	
R18	AA18	AG8	N12	AC15	V10	
R20	AA20	AG9	N23	AC17	V25	
R22	AA22	AG26	N24	AC18	V26	
T15	AB13	AK34	P9	AC20	AB8	
T17	AB14	AL1	P11	AC22	AB10	
T19	AB15	AL4	P24	AD13	AB25	
T21	AB16	AL32	P26	AD14	AB27	
T22	AB18	AM3	R11	AD15	AE13	
U13	AB20	AN2	R12	AD17	AE17	
U14	AB21	AN3	R23	AD18	AE18	
U16	AB22	AN33	R24	AD20	AE22	
U18		AP5	U11	AD21	AF17	
U20		AP31	U12	AD22	AF18	
V15			U23	AF14	AG13	
V17			U24	AF21	AG22	

Table 25 PES48H12AG2 Power Pins

Ground Pins

V _{SS}	V _{SS}	V _{SS}	V _{SS}	V _{SS}	V _{SS}	V _{SS}	V _{SS}
A1	C16	E33	G32	J32	M1	P14	T23
A2	C17	E34	H3	K3	M2	P16	T24
A5	C18	F1	H6	K6	M3	P18	T25
A8	C19	F2	H11	K11	M4	P20	T26
A11	C20	F3	H12	K12	M5	P23	T32
A14	C21	F4	H14	K14	M6	P25	U3
A17	C22	F5	H16	K16	M7	P29	U6
A20	C23	F6	H17	K19	M8	P30	U8
A23	C24	F7	H18	K21	M9	P31	U15
A26	C25	F8	H19	K23	M10	P32	U17
A29	C26	F9	H23	K24	M11	P33	U19
A33	C27	F12	H24	K29	M12	P34	U21
A34	C28	F13	H25	K32	M14	R1	U22
B1	C29	F15	H29	L3	M16	R2	U27
B5	D5	F16	H30	L6	M19	R3	U29
B8	D8	F18	H31	L7	M21	R4	U30
B11	D11	F21	H32	L8	M23	R5	U31
B14	D14	F22	H33	L9	M24	R6	U32
B17	D17	F24	H34	L10	M25	R9	U33
B20	D20	F25	J1	L11	M26	R15	U34
B23	D23	F26	J2	L12	M27	R17	V1
B26	D26	F27	J3	L16	M29	R19	V2
B29	D29	F28	J4	L19	M32	R21	V3
B34	E5	F29	J5	L23	N3	R26	V4
C5	E8	F32	J8	L24	N6	R28	V5
C6	E11	G3	J11	L25	N9	R32	V6
C7	E14	G6	J12	L26	N16	T3	V8
C8	E17	G9	J13	L27	N18	T10	V13
C9	E20	G10	J16	L28	N26	T11	V14
C10	E23	G13	J19	L29	N29	T12	V16
C11	E26	G16	J20	L30	N32	T13	V18
C12	E29	G21	J22	L31	P3	T14	V20
C13	E30	G24	J23	L32	P6	T16	V27
C14	E31	G25	J24	L33	P10	T18	V29
C15	E32	G29	J29	L34	P12	T20	V32

Table 26 PES48H12AG2 Ground Pins (Part 1 of 2)

V _{SS}	V _{SS}	V _{SS}	V _{SS}	V _{SS}	V _{SS}	V _{SS}	V _{SS}
W3	AA4	AC21	AE11	AG3	AJ6	AK18	AM26
W6	AA5	AC23	AE12	AG4	AJ7	AK21	AM27
W9	AA6	AC24	AE14	AG5	AJ8	AK24	AM28
W10	AA10	AC25	AE16	AG6	AJ9	AK27	AM29
W11	AA12	AC26	AE19	AG10	AJ10	AK30	AM30
W12	AA15	AC27	AE21	AG11	AJ11	AL6	AN1
W15	AA17	AC28	AE23	AG12	AJ13	AL9	AN6
W17	AA19	AC29	AE24	AG14	AJ17	AL12	AN9
W19	AA21	AC30	AE28	AG16	AJ18	AL15	AN12
W21	AA23	AC31	AE29	AG17	AJ19	AL18	AN15
W22	AA25	AC32	AE32	AG18	AJ20	AL21	AN18
W23	AA27	AC33	AF3	AG19	AJ21	AL24	AN21
W24	AA28	AC34	AF6	AG23	AJ22	AL27	AN24
W25	AA29	AD1	AF7	AG24	AJ23	AL30	AN27
W27	AA32	AD2	AF8	AG29	AJ24	AM6	AN30
W28	AB3	AD3	AF11	AG32	AJ25	AM7	AN34
W29	AB9	AD4	AF12	AH3	AJ26	AM8	AP1
W32	AB17	AD5	AF13	AH6	AJ27	AM9	AP2
Y3	AB19	AD6	AF15	AH9	AJ28	AM10	AP6
Y9	AB26	AD7	AF16	AH10	AJ29	AM11	AP9
Y14	AB28	AD8	AF19	AH11	AJ30	AM12	AP12
Y16	AB29	AD11	AF20	AH13	AJ31	AM13	AP15
Y18	AB32	AD12	AF22	AH19	AJ32	AM14	AP18
Y20	AC3	AD16	AF23	AH20	AJ33	AM15	AP21
Y26	AC6	AD19	AF24	AH21	AJ34	AM16	AP24
Y28	AC7	AD23	AF28	AH23	AK1	AM17	AP27
Y30	AC8	AD24	AF29	AH24	AK2	AM18	AP30
Y31	AC9	AD28	AF30	AH25	AK3	AM19	AP33
Y32	AC10	AD29	AF31	AH26	AK4	AM20	AP34
Y33	AC11	AD32	AF32	AH27	AK5	AM21	
Y34	AC12	AE3	AF33	AH28	AK6	AM22	
AA1	AC14	AE6	AF34	AH29	AK9	AM23	
AA2	AC16	AE7	AG1	AH32	AK12	AM24	
AA3	AC19	AE10	AG2	AJ3	AK15	AM25	

Table 26 PES48H12AG2 Ground Pins (Part 2 of 2)

No Connection Pins

NC	NC	NC	NC	NC	NC
G12	V34	AB33	AG33	AK28	AN26
G15	W26	AB34	AG34	AK29	AN28
G19	W30	AD9	AH16	AL19	AN29
G22	W31	AD10	AH22	AL20	AP19
N7	W33	AD30	AH30	AL22	AP20
N28	W34	AD31	AH31	AL23	AP22
T6	Y6	AD33	AH33	AL25	AP23
T29	Y29	AD34	AH34	AL26	AP25
U7	AA30	AE30	AJ14	AL28	AP26
U28	AA31	AE31	AK19	AL29	AP28
V7	AA33	AE33	AK20	AN19	AP29
V28	AA34	AE34	AK22	AN20	
V30	AB7	AG21	AK23	AN22	
V31	AB30	AG30	AK25	AN23	
V33	AB31	AG31	AK26	AN25	

Table 27 PES48H12AG2 No Connection Pins

Signals Listed Alphabetically

Signal Name	I/O Type	Location	Signal Category
CLKMODE0	I	AG7	System
CLKMODE1	I	K25	
CLKMODE2	I	AH7	
GCLKFSEL	I	AH8	
GCLKN0	I	G17	
GCLKN1	I	AH18	
GCLKP0	I	G18	
GCLKP1	I	AH17	
GPIO_00	I/O	AM31	General Purpose I/O
GPIO_01	I/O	AN31	
GPIO_02	I/O	AN32	
GPIO_03	I/O	AP32	
GPIO_04	I/O	AG27	
GPIO_05	I/O	AM32	

Table 28 PES48H12AG2 Alphabetical Signal List (Part 1 of 10)

Signal Name	I/O Type	Location	Signal Category
GPIO_06	I/O	AE25	General Purpose I/O (cont.)
GPIO_07	I/O	AL31	
GPIO_08	I/O	AK31	
GPIO_09	I/O	AF26	
GPIO_10	I/O	AL33	
GPIO_11	I/O	AM33	
GPIO_12	I/O	AL34	
GPIO_13	I/O	AM34	
GPIO_14	I/O	AK33	
GPIO_15	I/O	AK32	
GPIO_16	I/O	C4	
GPIO_17	I/O	B4	
GPIO_18	I/O	B3	
GPIO_19	I/O	A3	
GPIO_20	I/O	H8	
GPIO_21	I/O	C3	
GPIO_22	I/O	K10	
GPIO_23	I/O	D4	
GPIO_24	I/O	E4	
GPIO_25	I/O	J9	
GPIO_26	I/O	D2	
GPIO_27	I/O	C2	
GPIO_28	I/O	D1	
GPIO_29	I/O	C1	
GPIO_30	I/O	E2	
GPIO_31	I/O	E3	
GPIO_32	I/O	G28	
GPIO_33	I/O	G26	
GPIO_34	I/O	J28	
GPIO_35	I/O	K28	
GPIO_36	I/O	K27	
GPIO_37	I/O	AD27	
GPIO_38	I/O	AD26	
GPIO_39	I/O	AD25	
GPIO_40	I/O	AE27	
GPIO_41	I/O	AF27	

Table 28 PES48H12AG2 Alphabetical Signal List (Part 2 of 10)

Signal Name	I/O Type	Location	Signal Category
GPIO_42	I/O	AF25	General Purpose I/O (cont.)
GPIO_43	I/O	AG28	
GPIO_44	I/O	AG25	
GPIO_45	I/O	G8	
GPIO_46	I/O	G7	
GPIO_47	I/O	H10	
GPIO_48	I/O	H7	
GPIO_49	I/O	J10	
GPIO_50	I/O	J6	
GPIO_51	I/O	J7	
GPIO_52	I/O	K8	
GPIO_53	I/O	K7	
JTAG_TCK	I	K26	
JTAG_TDI	I	C31	
JTAG_TDO	O	J25	
JTAG_TMS	I	D30	
JTAG_TRST_N	I	C32	
MSMBADDR1	I	A31	SMBus Interface
MSMBADDR2	I	B31	
MSMBADDR3	I	B30	
MSMBADDR4	I	C30	
MSMBCLK	I/O	G27	
MSMBDAT	I/O	H26	
MSMBSMODE	I	A32	System
NO CONNECT	See Table 27 for a listing of No Connect pins.		
P00CLKN	I	T27	PCI Express
P00CLKP	I	T28	
P01CLKN	I	P27	
P01CLKP	I	P28	
P02CLKN	I	G23	
P02CLKP	I	F23	
P03CLKN	I	G20	
P03CLKP	I	F20	
P04CLKN	I	W8	
P04CLKP	I	W7	
P05CLKN	I	AA8	

Table 28 PES48H12AG2 Alphabetical Signal List (Part 3 of 10)

Signal Name	I/O Type	Location	Signal Category
P05CLKP	I	AA7	PCI Express (cont.)
P06CLKN	I	AH12	
P06CLKP	I	AJ12	
P07CLKN	I	AH15	
P07CLKP	I	AJ15	
P08CLKN	I	G14	
P08CLKP	I	F14	
P09CLKN	I	G11	
P09CLKP	I	F11	
P10CLKN	I	P8	
P10CLKP	I	P7	
P11CLKN	I	T8	
P11CLKP	I	T7	
P01Mergen	I	AL2	
P23Mergen	I	AM1	
P45Mergen	I	AL3	
P67Mergen	I	AM2	
P89Mergen	I	AL5	
P1011Mergen	I	AM4	
PE00RN0	I	T31	PCI Express
PE00RN1	I	R31	
PE00RN2	I	N31	
PE00RN3	I	M31	
PE00RP0	I	T30	
PE00RP1	I	R30	
PE00RP2	I	N30	
PE00RP3	I	M30	
PE00TN0	O	T33	
PE00TN1	O	R33	
PE00TN2	O	N33	
PE00TN3	O	M33	
PE00TP0	O	T34	
PE00TP1	O	R34	
PE00TP2	O	N34	
PE00TP3	O	M34	
PE01RN0	I	K31	

Table 28 PES48H12AG2 Alphabetical Signal List (Part 4 of 10)

Signal Name	I/O Type	Location	Signal Category
PE01RN1	I	J31	PCI Express (cont.)
PE01RN2	I	G31	
PE01RN3	I	F31	
PE01RP0	I	K30	
PE01RP1	I	J30	
PE01RP2	I	G30	
PE01RP3	I	F30	
PE01TN0	O	K33	
PE01TN1	O	J33	
PE01TN2	O	G33	
PE01TN3	O	F33	
PE01TP0	O	K34	
PE01TP1	O	J34	
PE01TP2	O	G34	
PE01TP3	O	F34	
PE02RN0	I	D28	
PE02RN1	I	D27	
PE02RN2	I	D25	
PE02RN3	I	D24	
PE02RP0	I	E28	
PE02RP1	I	E27	
PE02RP2	I	E25	
PE02RP3	I	E24	
PE02TN0	O	B28	
PE02TN1	O	B27	
PE02TN2	O	B25	
PE02TN3	O	B24	
PE02TP0	O	A28	
PE02TP1	O	A27	
PE02TP2	O	A25	
PE02TP3	O	A24	
PE03RN0	I	D22	
PE03RN1	I	D21	
PE03RN2	I	D19	
PE03RN3	I	D18	
PE03RP0	I	E22	

Table 28 PES48H12AG2 Alphabetical Signal List (Part 5 of 10)

Signal Name	I/O Type	Location	Signal Category
PE03RP1	I	E21	PCI Express (cont.)
PE03RP2	I	E19	
PE03RP3	I	E18	
PE03TN0	O	B22	
PE03TN1	O	B21	
PE03TN2	O	B19	
PE03TN3	O	B18	
PE03TP0	O	A22	
PE03TP1	O	A21	
PE03TP2	O	A19	
PE03TP3	O	A18	
PE04RN0	I	W4	
PE04RN1	I	Y4	
PE04RN2	I	AB4	
PE04RN3	I	AC4	
PE04RP0	I	W5	
PE04RP1	I	Y5	
PE04RP2	I	AB5	
PE04RP3	I	AC5	
PE04TN0	O	W2	
PE04TN1	O	Y2	
PE04TN2	O	AB2	
PE04TN3	O	AC2	
PE04TP0	O	W1	
PE04TP1	O	Y1	
PE04TP2	O	AB1	
PE04TP3	O	AC1	
PE05RN0	I	AE4	
PE05RN1	I	AF4	
PE05RN2	I	AH4	
PE05RN3	I	AJ4	
PE05RP0	I	AE5	
PE05RP1	I	AF5	
PE05RP2	I	AH5	
PE05RP3	I	AJ5	
PE05TN0	O	AE2	

Table 28 PES48H12AG2 Alphabetical Signal List (Part 6 of 10)

Signal Name	I/O Type	Location	Signal Category
PE05TN1	O	AF2	PCI Express (cont.)
PE05TN2	O	AH2	
PE05TN3	O	AJ2	
PE05TP0	O	AE1	
PE05TP1	O	AF1	
PE05TP2	O	AH1	
PE05TP3	O	AJ1	
PE06RN0	I	AL7	
PE06RN1	I	AL8	
PE06RN2	I	AL10	
PE06RN3	I	AL11	
PE06RP0	I	AK7	
PE06RP1	I	AK8	
PE06RP2	I	AK10	
PE06RP3	I	AK11	
PE06TN0	O	AN7	
PE06TN1	O	AN8	
PE06TN2	O	AN10	
PE06TN3	O	AN11	
PE06TP0	O	AP7	
PE06TP1	O	AP8	
PE06TP2	O	AP10	
PE06TP3	O	AP11	
PE07RN0	I	AL13	
PE07RN1	I	AL14	
PE07RN2	I	AL16	
PE07RN3	I	AL17	
PE07RP0	I	AK13	
PE07RP1	I	AK14	
PE07RP2	I	AK16	
PE07RP3	I	AK17	
PE07TN0	O	AN13	
PE07TN1	O	AN14	
PE07TN2	O	AN16	
PE07TN3	O	AN17	
PE07TP0	O	AP13	

Table 28 PES48H12AG2 Alphabetical Signal List (Part 7 of 10)

Signal Name	I/O Type	Location	Signal Category
PE07TP1	O	AP14	PCI Express (cont.)
PE07TP2	O	AP16	
PE07TP3	O	AP17	
PE08RN0	I	D16	
PE08RN1	I	D15	
PE08RN2	I	D13	
PE08RN3	I	D12	
PE08RP0	I	E16	
PE08RP1	I	E15	
PE08RP2	I	E13	
PE08RP3	I	E12	
PE08TN0	O	B16	
PE08TN1	O	B15	
PE08TN2	O	B13	
PE08TN3	O	B12	
PE08TP0	O	A16	
PE08TP1	O	A15	
PE08TP2	O	A13	
PE08TP3	O	A12	
PE09RN0	I	D10	
PE09RN1	I	D9	
PE09RN2	I	D7	
PE09RN3	I	D6	
PE09RP0	I	E10	
PE09RP1	I	E9	
PE09RP2	I	E7	
PE09RP3	I	E6	
PE09TN0	O	B10	
PE09TN1	O	B9	
PE09TN2	O	B7	
PE09TN3	O	B6	
PE09TP0	O	A10	
PE09TP1	O	A9	
PE09TP2	O	A7	
PE09TP3	O	A6	
PE10RN0	I	G4	

Table 28 PES48H12AG2 Alphabetical Signal List (Part 8 of 10)

Signal Name	I/O Type	Location	Signal Category
PE10RN1	I	H4	PCI Express (cont.)
PE10RN2	I	K4	
PE10RN3	I	L4	
PE10RP0	I	G5	
PE10RP1	I	H5	
PE10RP2	I	K5	
PE10RP3	I	L5	
PE10TN0	O	G2	
PE10TN1	O	H2	
PE10TN2	O	K2	
PE10TN3	O	L2	
PE10TP0	O	G1	
PE10TP1	O	H1	
PE10TP2	O	K1	
PE10TP3	O	L1	
PE11RN0	I	N4	
PE11RN1	I	P4	
PE11RN2	I	T4	
PE11RN3	I	U4	
PE11RP0	I	N5	
PE11RP1	I	P5	
PE11RP2	I	T5	
PE11RP3	I	U5	
PE11TN0	O	N2	
PE11TN1	O	P2	
PE11TN2	O	T2	
PE11TN3	O	U2	
PE11TP0	O	N1	
PE11TP1	O	P1	
PE11TP2	O	T1	
PE11TP3	O	U1	
PERSTN	I	B32	System









Table 28 PES48H12AG2 Alphabetical Signal List (Part 9 of 10)

Signal Name	I/O Type	Location	Signal Category
REFRES00	I/O	R29	SerDes Reference Resistors
REFRES01	I/O	M28	
REFRES02	I/O	H21	
REFRES03	I/O	F19	
REFRES04	I/O	Y7	
REFRES05	I/O	AB6	
REFRES06	I/O	AH14	
REFRES07	I/O	AJ16	
REFRES08	I/O	J15	
REFRES09	I/O	F10	
REFRES10	I/O	R7	
REFRES11	I/O	T9	
REFRESPLL	I/O	F17	
RSTHALT	I	AP3	System
SSMBADDR1	I	C34	SMBus Interface
SSMBADDR2	I	C33	
SSMBADDR3	I	D33	
SSMBADDR5	I	D32	
SSMBCLK	I/O	H28	
SSMBDAT	I/O	J27	
SWMODE0	I	AN4	System
SWMODE1	I	AP4	
SWMODE2	I	AN5	
SWMODE3	I	AM5	
V _{DD} CORE, V _{DD} I/O, V _{DD} PEA, V _{DD} PEHA, V _{DD} PETA	See Table 25 for a listing of power pins.		
V _{SS}	See Table 26 for a listing of ground pins.		

Table 28 PES48H12AG2 Alphabetical Signal List (Part 10 of 10)

PES48H12AG2 Pinout — Top View

	1	2	3	4	5	6	7	8	9	10	11	12	13	14	15	16	17	18	19	20	21	22	23	24	25	26	27	28	29	30	31	32	33	34		
A	✓	✓	□	✗	✓	□	□	✓	□	□	✓	□	□	✓	□	□	✓	□	□	✓	□	□	✓	□	□	✓	□	□	✓	✗	□	□	✓	✓	A	
B	✓	✗	□	□	✓	□	□	✓	□	□	✓	□	□	✓	□	□	✓	□	□	✓	□	□	✓	□	□	✓	□	□	✓	□	□	✓	✗	✓	B	
C	□	□	□	✓	✓	✓	✓	✓	✓	✓	✓	✓	✓	✓	✓	✓	✓	✓	✓	✓	✓	✓	✓	✓	✓	✓	✓	✓	✓	✓	✓	✓	✓	✓	C	
D	□	□	✗	□	✓	□	□	✓	□	□	✓	□	□	✓	□	□	✓	□	□	✓	□	□	✓	□	□	✓	□	□	✓	□	□	✓	✗	✓	D	
E	✗	□	□	✓	□	□	✓	□	□	✓	□	□	✓	□	□	✓	□	□	✓	□	□	✓	□	□	✓	□	□	✓	✓	✓	✓	✓	✓	✓	E	
F	✓	✓	✓	✓	✓	✓	✓	✓	✓	✓	✓	✓	✓	✓	✓	✓	✓	✓	✓	✓	✓	✓	✓	✓	✓	✓	✓	✓	✓	✓	✓	✓	✓	✓	F	
G	□	□	✓	□	□	✓	□	□	✓	□	□	✗	✓	□	✗	✓	□	□	✗	✓	□	□	✗	✓	□	□	✓	□	□	✓	□	□	✓	□	G	
H	□	□	✓	□	□	✓	□	□	✗	✓	✓	✗	✓	✗	✓	✓	✓	✓	✓	✗	□	✗	✓	✓	✓	✓	✓	✓	✓	✓	✓	✓	✓	✓	H	
J	✓	✓	✓	✓	✓	□	□	✓	□	□	✓	✓	+	□	✓	✗	✗	+	+	+	+	+	+	+	+	+	+	+	+	+	+	+	+	J		
K	□	□	✓	□	□	✓	□	□	✗	✓	✓	✗	+	✗	+	+	+	+	+	+	+	+	+	+	+	+	+	+	+	+	+	+	+	+	K	
L	□	□	✓	□	□	✓	✓	✓	✓	✓	✓	+	+	+	+	+	+	+	+	+	+	+	+	+	+	+	+	+	+	+	+	+	+	+	L	
M	✓	✓	✓	✓	✓	✓	✓	✓	✓	✓	✓	+	+	+	+	+	+	+	+	+	+	+	+	+	+	+	+	+	+	+	+	+	+	+	M	
N	□	□	✓	□	□	✓	✗	✗	+	+	+	+	+	+	+	+	+	+	+	+	+	+	+	+	+	+	+	+	+	+	+	+	+	+	N	
P	□	□	✓	□	□	✓	□	□	+	+	+	+	+	+	+	+	+	+	+	+	+	+	+	+	+	+	+	+	+	+	+	+	+	+	P	
R	✓	✓	✓	✓	✓	✓	✗	✗	+	+	+	+	+	+	+	+	+	+	+	+	+	+	+	+	+	+	+	+	+	+	+	+	+	+	R	
T	□	□	✓	□	□	✓	□	□	✓	✓	✓	✓	✓	✓	✓	✓	✓	✓	✓	✓	✓	✓	✓	✓	✓	✓	✓	✓	✓	✓	✓	✓	✓	✓	T	
U	□	□	✓	□	□	✓	✗	✗	+	+	+	+	+	+	+	+	+	+	+	+	+	+	+	+	+	+	+	+	+	+	+	+	+	+	U	
V	✓	✓	✓	✓	✓	✓	✗	✗	+	+	+	+	+	+	+	+	+	+	+	+	+	+	+	+	+	+	+	+	+	+	+	+	+	+	V	
W	□	□	✓	□	□	✓	□	□	✓	✓	✓	✓	✓	✓	✓	✓	✓	✓	✓	✓	✓	✓	✓	✓	✓	✓	✓	✓	✓	✓	✓	✓	✓	✓	W	
Y	□	□	✓	□	□	✓	□	✗	✗	+	+	+	+	+	+	+	+	+	+	+	+	+	+	+	+	+	+	+	+	+	+	+	+	+	Y	
AA	✓	✓	✓	✓	✓	✓	□	□	+	+	+	+	+	+	+	+	+	+	+	+	+	+	+	+	+	+	+	+	+	+	+	+	+	+	AA	
AB	□	□	✓	□	□	✓	✗	✗	+	+	+	+	+	+	+	+	+	+	+	+	+	+	+	+	+	+	+	+	+	+	+	+	+	+	AB	
AC	□	□	✓	□	□	✓	✓	✓	✓	✓	✓	+	+	+	+	+	+	+	+	+	+	+	+	+	+	+	+	+	+	+	+	+	+	+	AC	
AD	✓	✓	✓	✓	✓	✓	✓	✓	✓	✓	✓	+	+	+	+	+	+	+	+	+	+	+	+	+	+	+	+	+	+	+	+	+	+	+	AD	
AE	□	□	✓	□	□	✓	✗	✗	+	+	+	+	+	+	+	+	+	+	+	+	+	+	+	+	+	+	+	+	+	+	+	+	+	+	AE	
AF	□	□	✓	□	□	✓	✓	✓	✓	✓	✓	+	+	+	+	+	+	+	+	+	+	+	+	+	+	+	+	+	+	+	+	+	+	+	AF	
AG	✓	✓	✓	✓	✓	✓	✗	✗	+	+	+	+	+	+	+	+	+	+	+	+	+	+	+	+	+	+	+	+	+	+	+	+	+	+	AG	
AH	□	□	✓	□	□	✓	□	□	✓	✓	✓	□	□	✗	□	□	✓	✓	✓	✓	✓	✓	✓	✓	✓	✓	✓	✓	✓	✓	✓	✓	✓	✓	AH	
AJ	□	□	✓	□	□	✓	✓	✓	✓	✓	✓	✓	✓	✓	✓	✓	✓	✓	✓	✓	✓	✓	✓	✓	✓	✓	✓	✓	✓	✓	✓	✓	✓	✓	✓	AJ
AK	✓	✓	✓	✓	✓	✓	□	□	✓	□	□	✓	□	□	✓	□	□	✓	□	□	✓	□	□	✓	□	□	✓	□	□	✓	□	□	✓	✗	AK	
AL	✗	□	□	✗	□	✓	□	□	✓	□	□	✓	□	□	✓	□	□	✓	□	□	✓	□	□	✓	□	□	✓	□	□	✓	□	□	✓	□	AL	
AM	□	□	✗	□	□	✓	✓	✓	✓	✓	✓	✓	✓	✓	✓	✓	✓	✓	✓	✓	✓	✓	✓	✓	✓	✓	✓	✓	✓	✓	✓	✓	✓	✓	✓	AM
AN	✓	✗	✗	□	□	✓	□	□	✓	□	□	✓	□	□	✓	□	□	✓	□	□	✓	□	□	✓	□	□	✓	□	□	✓	□	□	✓	✗	AN	
AP	✓	✓	□	□	✗	✓	□	□	✓	□	□	✓	□	□	✓	□	□	✓	□	□	✓	□	□	✓	□	□	✓	□	□	✓	□	□	✓	✓	AP	

 V _{DD} Core (Power)	 V _{DD} PETA (Transmitter Power)	 Signals
 V _{DD} I/O (Power)	 V _{DD} PEA (Analog Power)	 No connect
 V _{SS} (Ground)	 V _{DD} PEHA (High Analog Power)	

PES48H12AG2 Package Drawing — 1156-Pin BL1156/BR1156

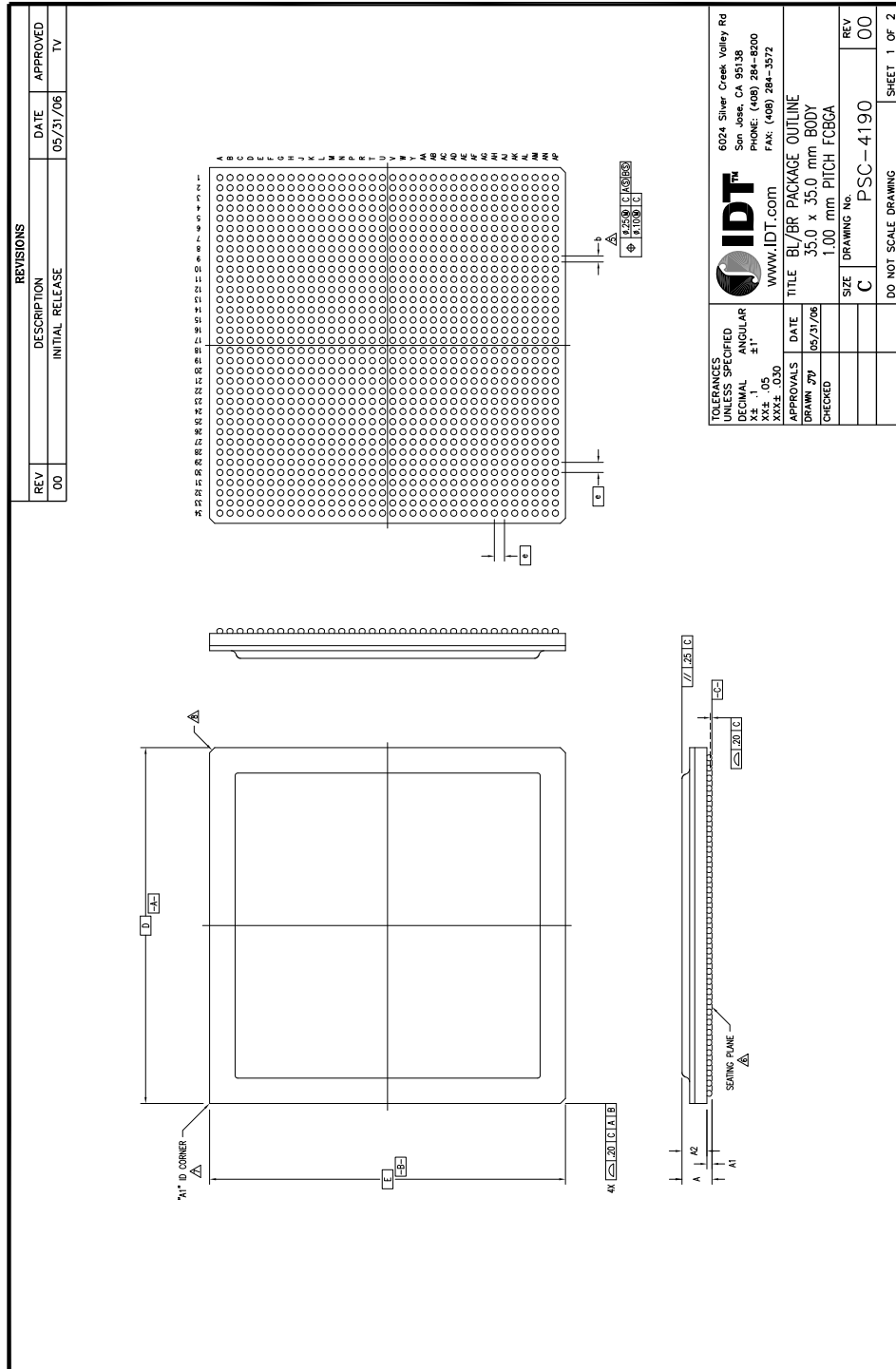



Revision History

January 21, 2010: Publication of Final datasheet.

March 30, 2011: In [Table 14](#), added $V_{DD}PETA$ to footnote #1.

November 28, 2011: Added new Tables 21 and 22, SMBus Characterization and Timing.

December 12, 2013: Removed the Alt information for [AE25-GPIO_06](#).

Ordering Information

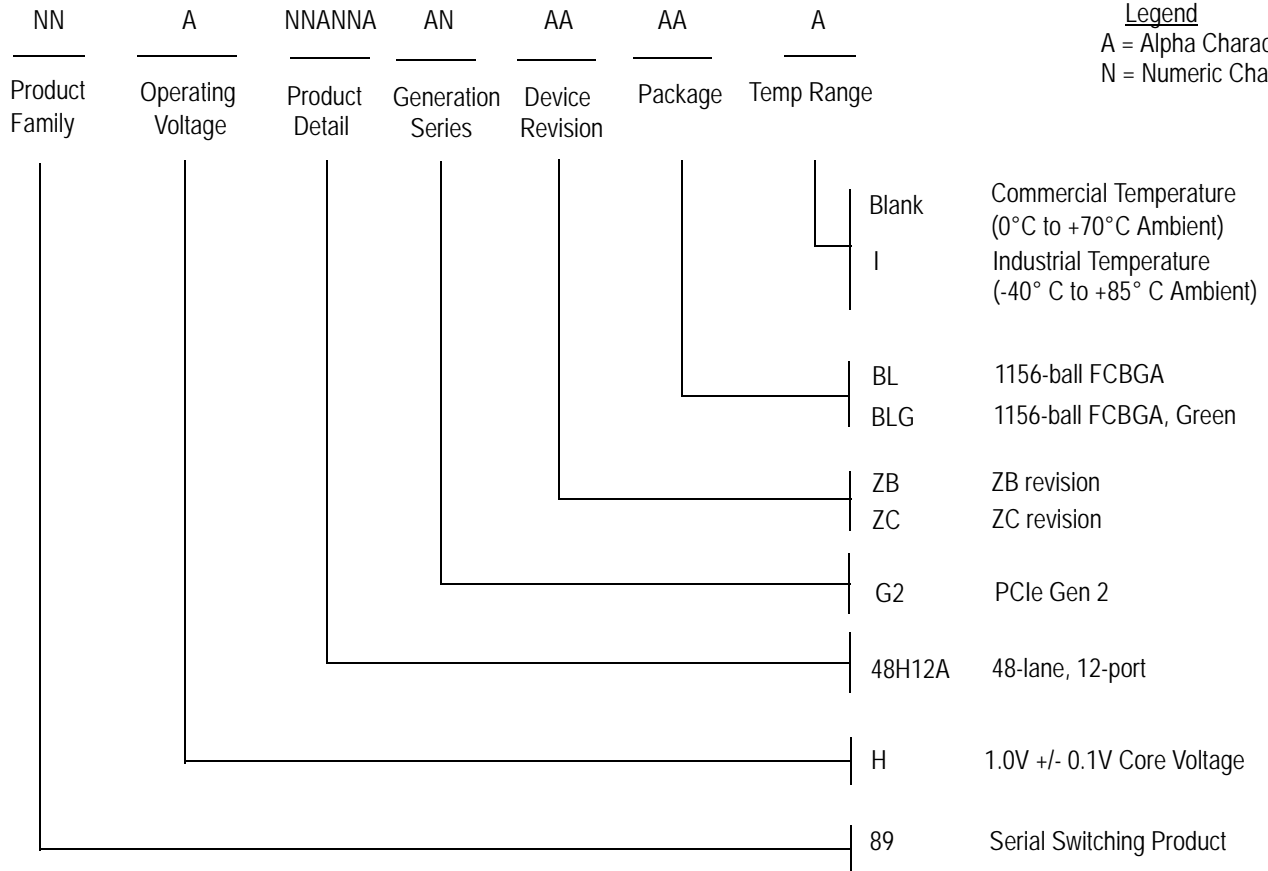

Legend

A = Alpha Character
N = Numeric Character

Valid Combinations

89H48H12AG2ZBBL	1156-ball FCBGA package, Commercial Temperature
89H48H12AG2ZBBLG	1156-ball Green FCBGA package, Commercial Temperature
89H48H12AG2ZBBLI	1156-ball FCBGA package, Industrial Temperature
89H48H12AG2ZBBLGI	1156-ball Green FCBGA package, Industrial Temperature
89H48H12AG2ZCBL	1156-ball FCBGA package, Commercial Temperature
89H48H12AG2ZCBLG	1156-ball Green FCBGA package, Commercial Temperature
89H48H12AG2ZCBLI	1156-ball FCBGA package, Industrial Temperature
89H48H12AG2ZCBLGI	1156-ball Green FCBGA package, Industrial Temperature



CORPORATE HEADQUARTERS
6024 Silver Creek Valley Road
San Jose, CA 95138

for SALES:
800-345-7015 or 408-284-8200
fax: 408-284-2775
www.idt.com

for Tech Support:
email: ssdhelp@eng.idt.com

Компания «Life Electronics» занимается поставками электронных компонентов импортного и отечественного производства от производителей и со складов крупных дистрибьюторов Европы, Америки и Азии.

С конца 2013 года компания активно расширяет линейку поставок компонентов по направлению коаксиальный кабель, кварцевые генераторы и конденсаторы (керамические, пленочные, электролитические), за счёт заключения дистрибьюторских договоров

Мы предлагаем:

- Конкурентоспособные цены и скидки постоянным клиентам.
- Специальные условия для постоянных клиентов.
- Подбор аналогов.
- Поставку компонентов в любых объемах, удовлетворяющих вашим потребностям.
- Приемлемые сроки поставки, возможна ускоренная поставка.
- Доставку товара в любую точку России и стран СНГ.
- Комплексную поставку.
- Работу по проектам и поставку образцов.
- Формирование склада под заказчика.
- Сертификаты соответствия на поставляемую продукцию (по желанию клиента).
- Тестирование поставляемой продукции.
- Поставку компонентов, требующих военную и космическую приемку.
- Входной контроль качества.
- Наличие сертификата ISO.

В составе нашей компании организован Конструкторский отдел, призванный помогать разработчикам, и инженерам.

Конструкторский отдел помогает осуществить:

- Регистрацию проекта у производителя компонентов.
- Техническую поддержку проекта.
- Защиту от снятия компонента с производства.
- Оценку стоимости проекта по компонентам.
- Изготовление тестовой платы монтаж и пусконаладочные работы.



Тел: +7 (812) 336 43 04 (многоканальный)

Email: org@lifeelectronics.ru