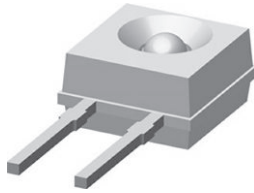


Infrared Emitting Diode, 950 nm, GaAs



14354

DESCRIPTION

The TSKS5400S is an infrared, 950 nm emitting diode in GaAs technology with high radiant power, molded in a clear plastic package.

FEATURES

- Package type: leaded
- Package form: side view lens
- Dimensions (L x W x H in mm): 5 x 2.65 x 5
- Peak wavelength: $\lambda_p = 950$ nm
- High reliability
- High radiant power
- High radiant intensity
- Angle of half intensity: $\phi = \pm 30^\circ$
- Low forward voltage
- Suitable for high pulse current operation
- Good spectral matching with Si photodetectors
- Package matched with detector TEKS5400
- Compliant to RoHS Directive 2002/95/EC and in accordance to WEEE 2002/96/EC



Note

** Please see document "Vishay Material Category Policy": www.vishay.com/doc?99902

APPLICATIONS

- Photointerrupters
- Transmissive sensors, gap sensors
- Reflective sensors

PRODUCT SUMMARY				
COMPONENT	I_e (mW/sr)	ϕ (deg)	λ_p (nm)	t_r (ns)
TSKS5400S	4.5	± 30	950	800

Note

- Test conditions see table "Basic Characteristics"

ORDERING INFORMATION			
ORDERING CODE	PACKAGING	REMARKS	PACKAGE FORM
TSKS5400S	Bulk	MOQ: 2000 pcs, 2000 pcs/bulk	Side view lens

Note

- MOQ: minimum order quantity

ABSOLUTE MAXIMUM RATINGS ($T_{amb} = 25^\circ\text{C}$, unless otherwise specified)				
PARAMETER	TEST CONDITION	SYMBOL	VALUE	UNIT
Reverse voltage		V_R	6	V
Forward current		I_F	100	mA
Surge forward current	$t_p \leq 100 \mu\text{s}$	I_{FSM}	2	A
Power dissipation		P_V	170	mW
Junction temperature		T_J	100	$^\circ\text{C}$
Operating temperature range		T_{amb}	- 25 to + 85	$^\circ\text{C}$
Storage temperature range		T_{stg}	- 40 to + 100	$^\circ\text{C}$
Soldering temperature	$t \leq 5$ s, 2 mm from case	T_{sd}	260	$^\circ\text{C}$
Thermal resistance junction/ambient	J-STD-051, leads 7 mm, soldered on PCB	R_{thJA}	270	K/W

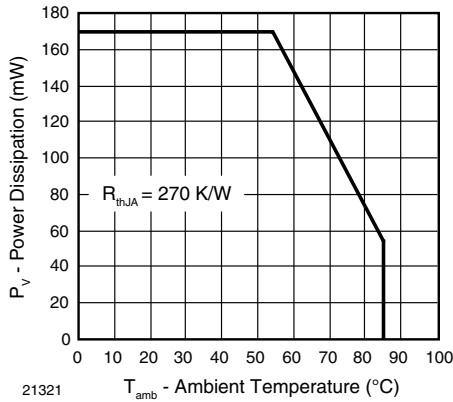


Fig. 1 - Power Dissipation Limit vs. Ambient Temperature

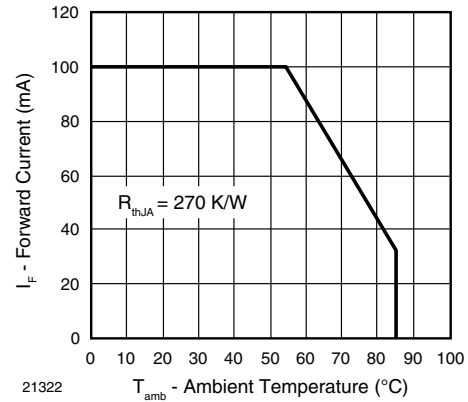


Fig. 2 - Forward Current Limit vs. Ambient Temperature

BASIC CHARACTERISTICS ($T_{amb} = 25\text{ }^{\circ}\text{C}$, unless otherwise specified)						
PARAMETER	TEST CONDITION	SYMBOL	MIN.	TYP.	MAX.	UNIT
Forward voltage	$I_F = 100\text{ mA}$, $t_p \leq 20\text{ ms}$	V_F		1.3	1.7	V
Reverse voltage	$I_R = 10\text{ }\mu\text{A}$	V_R	6			V
Temperature coefficient of V_F	$I_F = 100\text{ mA}$	TK_{V_F}		-1.3		mV/K
Junction capacitance	$V_R = 0\text{ V}$, $f = 1\text{ MHz}$, $E = 0$	C_j		50		pF
Radiant intensity	$I_F = 100\text{ mA}$, $t_p \leq 20\text{ ms}$	I_e	2	4.5	7	mW/sr
Radiant power	$I_F = 50\text{ mA}$, $t_p \leq 20\text{ ms}$	ϕ_e		10		mW
Temperature coefficient of ϕ_e	$I_F = 50\text{ mA}$	TK_{ϕ_e}		-1.0		%/K
Angle of half sensitivity		ϕ		± 30		deg
Peak wavelength	$I_F = 50\text{ mA}$	λ_p		950		nm
Spectral bandwidth	$I_F = 50\text{ mA}$	$\Delta\lambda$		50		nm
Rise time	$I_F = 100\text{ mA}$	t_r		800		ns
	$I_F = 1\text{ A}$, $t_p/T = 0.01$, $t_p \leq 10\text{ }\mu\text{s}$	t_r		450		ns

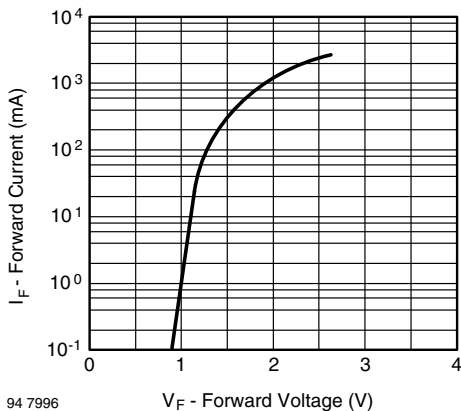
BASIC CHARACTERISTICS ($T_{amb} = 25\text{ }^{\circ}\text{C}$, unless otherwise specified)


Fig. 3 - Pulse Forward Current vs. Forward Voltage

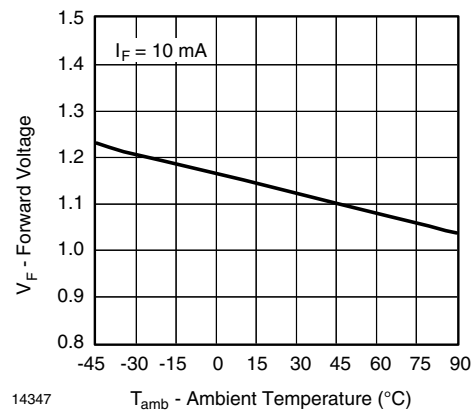
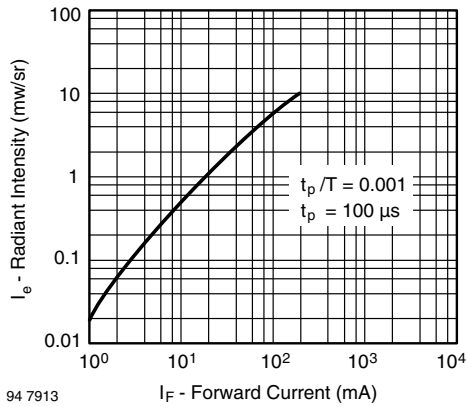
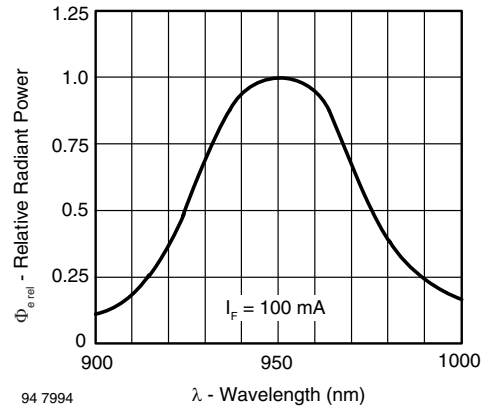


Fig. 4 - Forward Voltage vs. Ambient Temperature



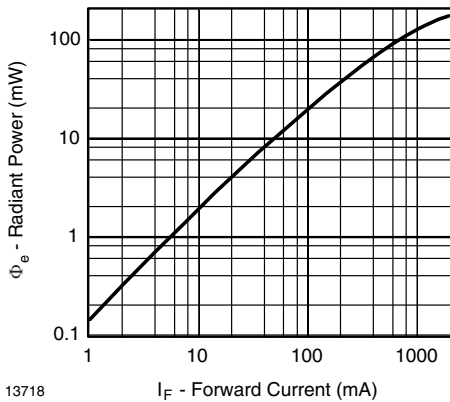
94 7913

Fig. 5 - Radiant Intensity vs. Forward Current



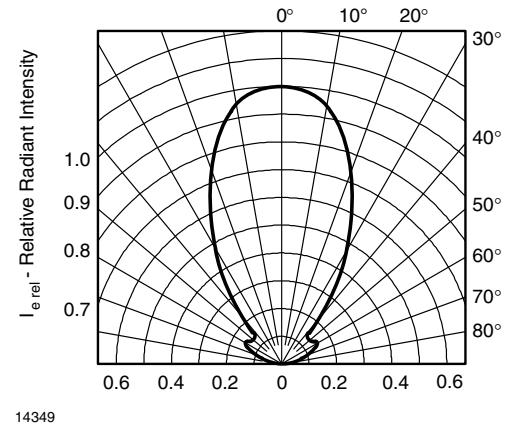
94 7994

Fig. 8 - Relative Radiant Power vs. Wavelength



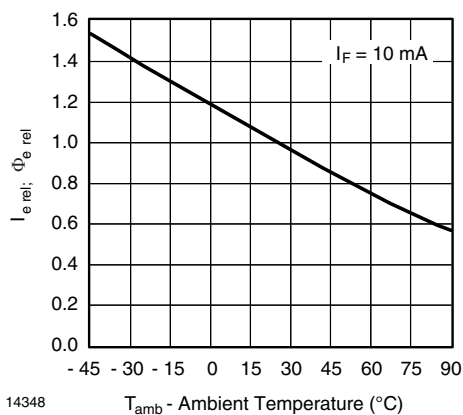
13718

Fig. 6 - Radiant Power vs. Forward Current



14349

Fig. 9 - Relative Radiant Intensity vs. Angular Displacement

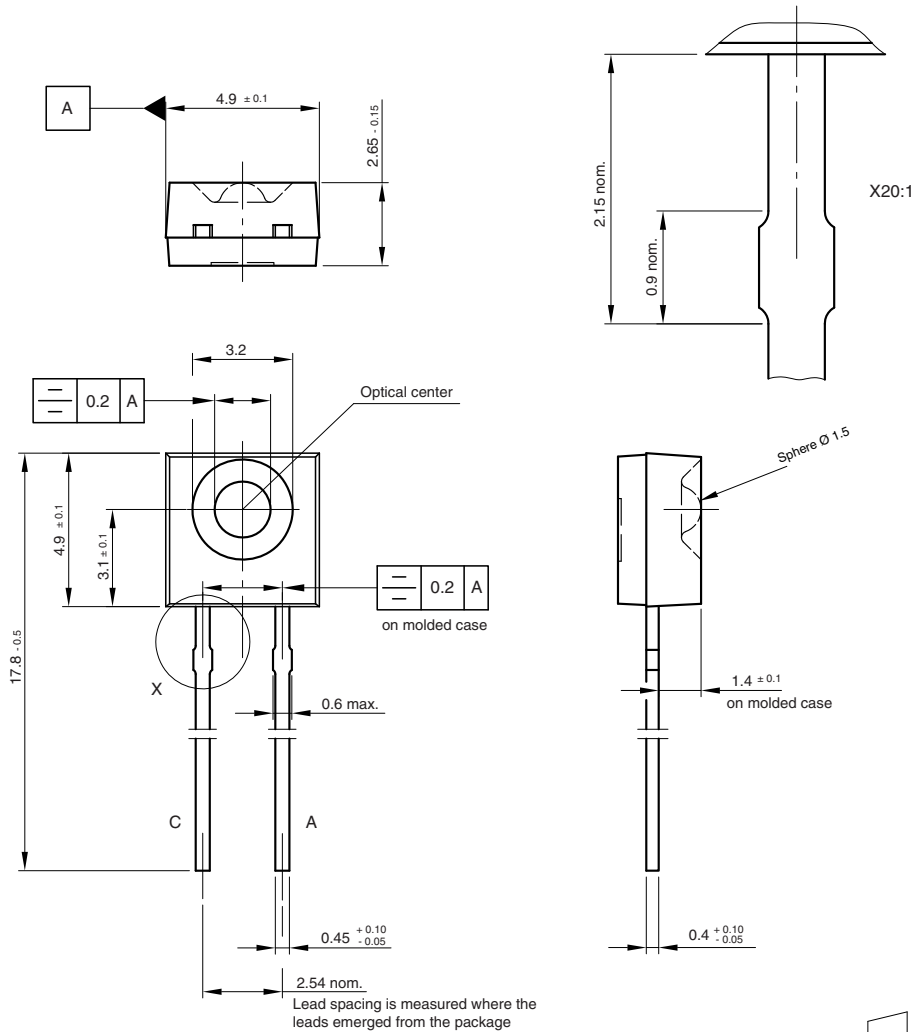


14348

Fig. 7 - Relative Radiant Intensity vs. Ambient Temperature

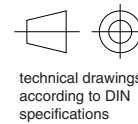


PACKAGE DIMENSIONS in millimeters



Protruded resin area where the leads emerged from the package 0.8 max.

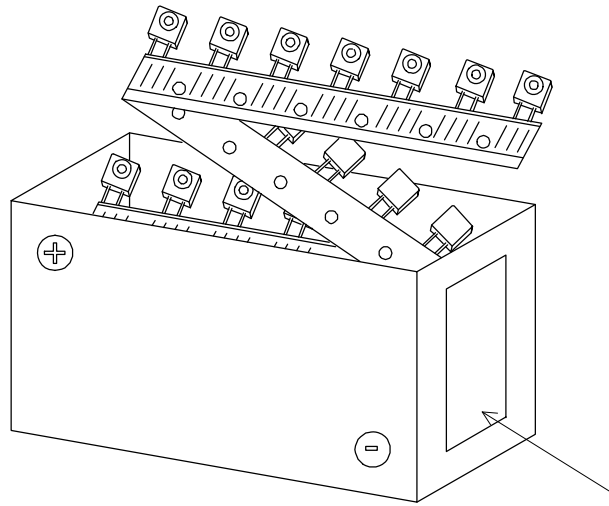
Drawing-No.: 6.544-5306.51-4
Issue: 6; 04.07.02
14307



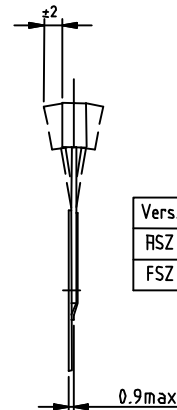
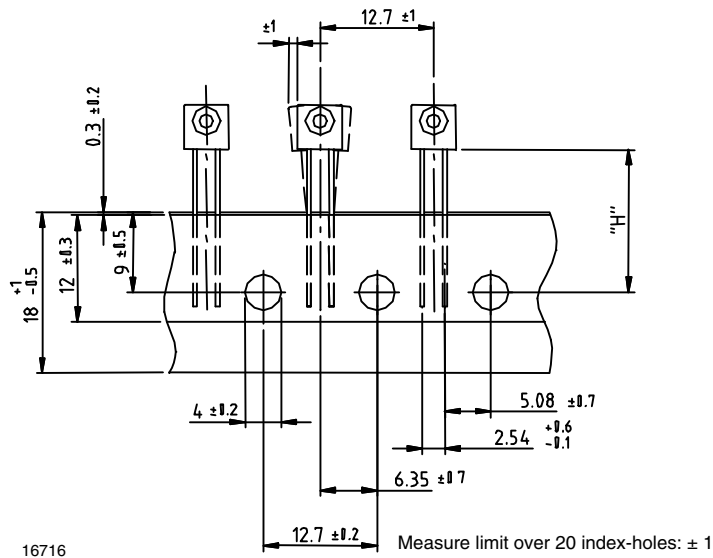
technical drawings according to DIN specifications



TAPE AND AMMOPACK STANDARDS DIMENSIONS in millimeters



Labeling: barcode-label see 5.6.4



Vers.	Dim. "H"
RSZ	16 ±0.5
FSZ	27 ±0.5



Disclaimer

ALL PRODUCT, PRODUCT SPECIFICATIONS AND DATA ARE SUBJECT TO CHANGE WITHOUT NOTICE TO IMPROVE RELIABILITY, FUNCTION OR DESIGN OR OTHERWISE.

Vishay Intertechnology, Inc., its affiliates, agents, and employees, and all persons acting on its or their behalf (collectively, "Vishay"), disclaim any and all liability for any errors, inaccuracies or incompleteness contained in any datasheet or in any other disclosure relating to any product.

Vishay makes no warranty, representation or guarantee regarding the suitability of the products for any particular purpose or the continuing production of any product. To the maximum extent permitted by applicable law, Vishay disclaims (i) any and all liability arising out of the application or use of any product, (ii) any and all liability, including without limitation special, consequential or incidental damages, and (iii) any and all implied warranties, including warranties of fitness for particular purpose, non-infringement and merchantability.

Statements regarding the suitability of products for certain types of applications are based on Vishay's knowledge of typical requirements that are often placed on Vishay products in generic applications. Such statements are not binding statements about the suitability of products for a particular application. It is the customer's responsibility to validate that a particular product with the properties described in the product specification is suitable for use in a particular application. Parameters provided in datasheets and/or specifications may vary in different applications and performance may vary over time. All operating parameters, including typical parameters, must be validated for each customer application by the customer's technical experts. Product specifications do not expand or otherwise modify Vishay's terms and conditions of purchase, including but not limited to the warranty expressed therein.

Except as expressly indicated in writing, Vishay products are not designed for use in medical, life-saving, or life-sustaining applications or for any other application in which the failure of the Vishay product could result in personal injury or death. Customers using or selling Vishay products not expressly indicated for use in such applications do so at their own risk. Please contact authorized Vishay personnel to obtain written terms and conditions regarding products designed for such applications.

No license, express or implied, by estoppel or otherwise, to any intellectual property rights is granted by this document or by any conduct of Vishay. Product names and markings noted herein may be trademarks of their respective owners.

Material Category Policy

Vishay Intertechnology, Inc. hereby certifies that all its products that are identified as RoHS-Compliant fulfill the definitions and restrictions defined under Directive 2011/65/EU of The European Parliament and of the Council of June 8, 2011 on the restriction of the use of certain hazardous substances in electrical and electronic equipment (EEE) - recast, unless otherwise specified as non-compliant.

Please note that some Vishay documentation may still make reference to RoHS Directive 2002/95/EC. We confirm that all the products identified as being compliant to Directive 2002/95/EC conform to Directive 2011/65/EU.

Vishay Intertechnology, Inc. hereby certifies that all its products that are identified as Halogen-Free follow Halogen-Free requirements as per JEDEC JS709A standards. Please note that some Vishay documentation may still make reference to the IEC 61249-2-21 definition. We confirm that all the products identified as being compliant to IEC 61249-2-21 conform to JEDEC JS709A standards.

Компания «Life Electronics» занимается поставками электронных компонентов импортного и отечественного производства от производителей и со складов крупных дистрибьюторов Европы, Америки и Азии.

С конца 2013 года компания активно расширяет линейку поставок компонентов по направлению коаксиальный кабель, кварцевые генераторы и конденсаторы (керамические, пленочные, электролитические), за счёт заключения дистрибьюторских договоров

Мы предлагаем:

- Конкуренеспособные цены и скидки постоянным клиентам.
- Специальные условия для постоянных клиентов.
- Подбор аналогов.
- Поставку компонентов в любых объемах, удовлетворяющих вашим потребностям.
- Приемлемые сроки поставки, возможна ускоренная поставка.
- Доставку товара в любую точку России и стран СНГ.
- Комплексную поставку.
- Работу по проектам и поставку образцов.
- Формирование склада под заказчика.
- Сертификаты соответствия на поставляемую продукцию (по желанию клиента).
- Тестирование поставляемой продукции.
- Поставку компонентов, требующих военную и космическую приемку.
- Входной контроль качества.
- Наличие сертификата ISO.

В составе нашей компании организован Конструкторский отдел, призванный помогать разработчикам, и инженерам.

Конструкторский отдел помогает осуществить:

- Регистрацию проекта у производителя компонентов.
- Техническую поддержку проекта.
- Защиту от снятия компонента с производства.
- Оценку стоимости проекта по компонентам.
- Изготовление тестовой платы монтаж и пусконаладочные работы.



Тел: +7 (812) 336 43 04 (многоканальный)

Email: org@lifeelectronics.ru