

# MAX14001/MAX14002 Evaluation System

Evaluates: MAX14001, MAX14002

## General Description

The MAX14001/14002 evaluation system (EV system) provides the hardware and software necessary to evaluate the MAX14001 and MAX14002 isolated, single-channel, analog-to-digital converters (ADCs) with programmable voltage comparators and inrush current control optimized for configurable binary input applications. The MAX14001/MAX14002 EV kit has Pmod™ compatible connectors for SPI communication. The EV system includes the USB2PMB2 adapter board that receives commands from a PC through the USB cable to create an SPI interface for communication between the software and the MAX14001/MAX14002 on the EV kit.

The EV system includes a graphical user interface (GUI) that provides communication between the target device and the PC. The MAX14001/MAX14002 EV kit has two MAX14001/MAX14002 devices (U1 and U2) that can operate in multiple modes, as shown in [Figure 1](#):

- 1) Single Channel mode: The USB2PMB2 adapter connects to connector PMOD1 or PMOD2 on the EV kit, depending on which channel is preferred, allowing differently configured analog inputs with signal conditioning circuitry.
- 2) Daisy-Chain mode: The USB2PMB2 adapter connects to connector PMOD1, and DOUT from U1 connects to DIN of U2. Both U1 and U2 are controlled from a single SPI interface.
- 3) Dual Channel mode: The USB2PMB2 adapter connects to connector PMOD1 and uses two chip-select signals ( $\overline{CS1}$  and  $\overline{CS2}$ ) to control each chip through a single connector/GUI interface.

## EV System Contents

- MAX14001EVKIT#, including the MAX14001AAP+ or MAX14002EVKIT#, including the MAX14002AAP+
- USB2PMB2# Adapter Board
- Micro-USB Cable

## Features

- Easy Evaluation of the MAX14001/MAX14002
- EV Kit is USB Powered
- Daisy-Chainable SPI Interface
- Internal Voltage Reference or External Voltage Reference
- Half-Wave Input Rectification Filter or Full-Wave Input Rectification Filter
- Windows XP®, Windows® 7, Windows 8.1, and Windows 10 Compatible Software
- Fully Assembled and Tested
- Proven PCB Layout
- RoHS Compliant

Ordering Information appears at end of data sheet.

*Windows and Windows XP are registered trademarks and registered service marks of Microsoft Corporation.*

*Pmod is a trademark of Digilent, Inc*

# MAX14001/MAX14002 Evaluation System

Evaluates: MAX14001, MAX14002

## MAX14001/MAX14002 EV Kit Photo

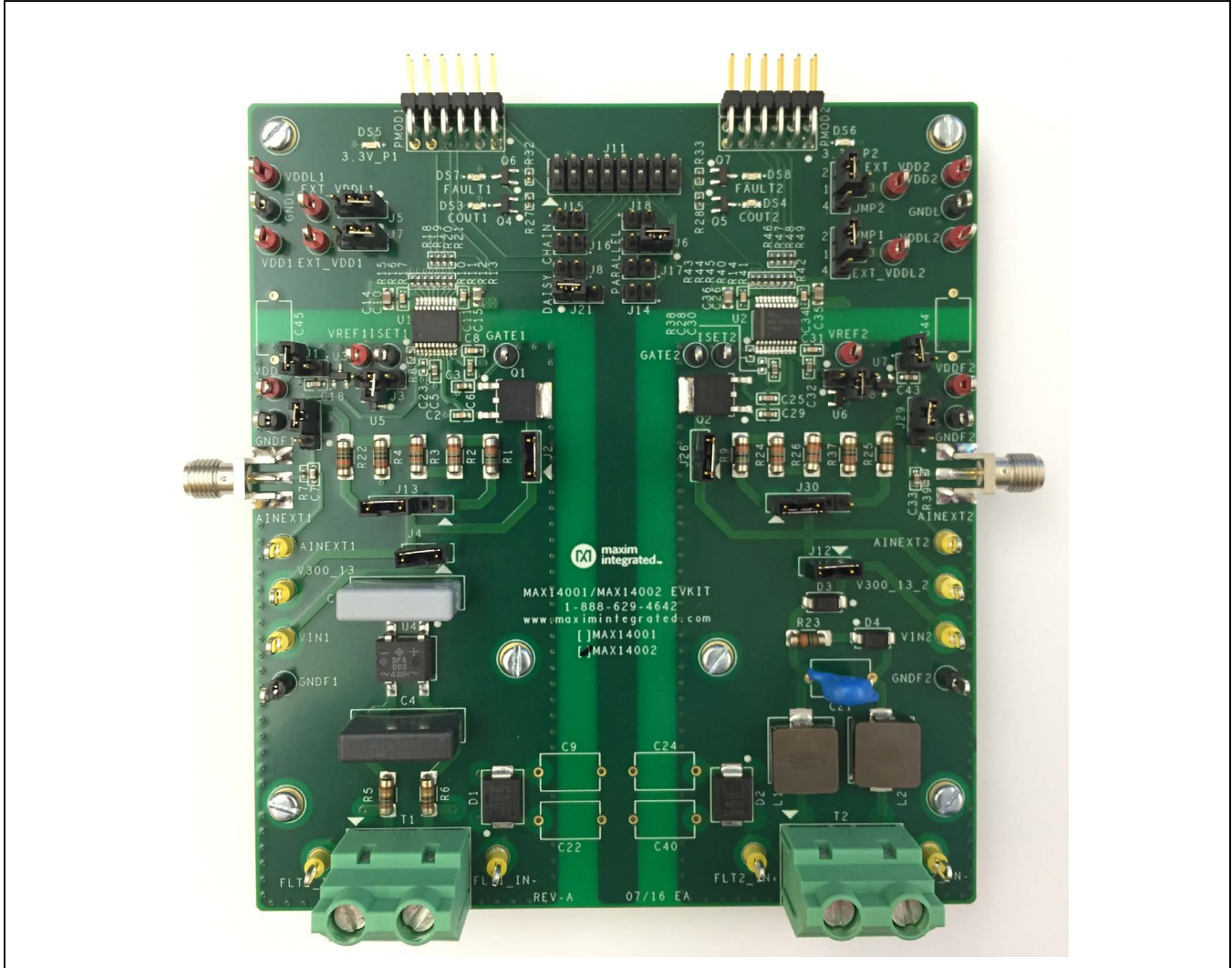

## USB2PMB2 Adapter Board Photo

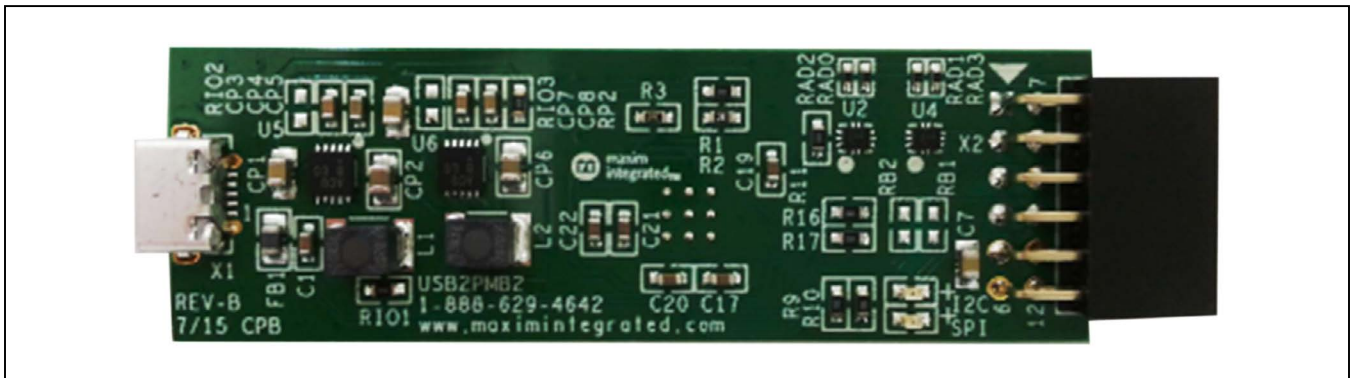

# MAX14001/MAX14002 Evaluation System

Evaluates: MAX14001, MAX14002

## MAX14001/MAX14002 EV System Photo

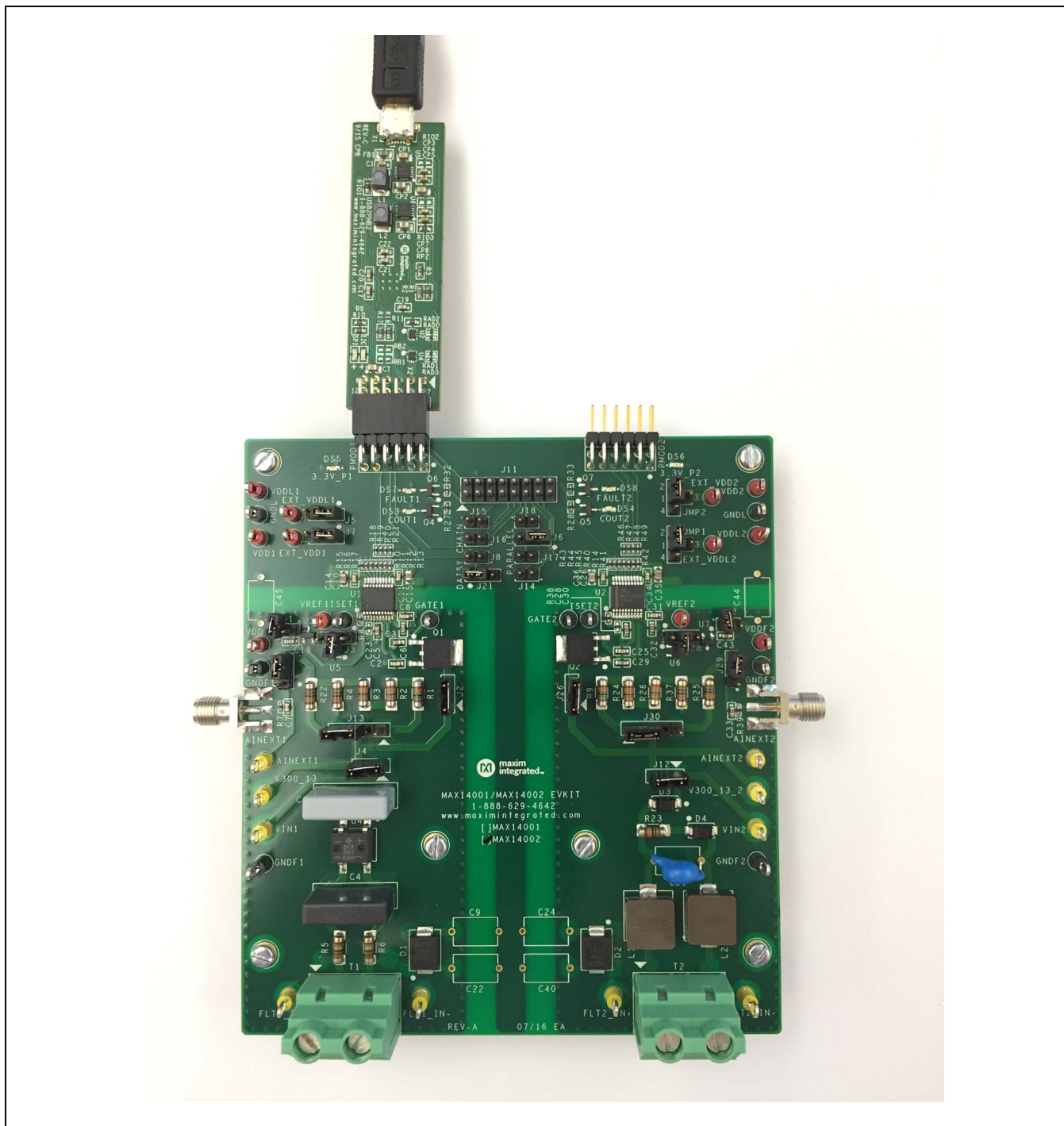

**Note:** Board standoffs and screws are not included in the EV system.

System Block Diagram

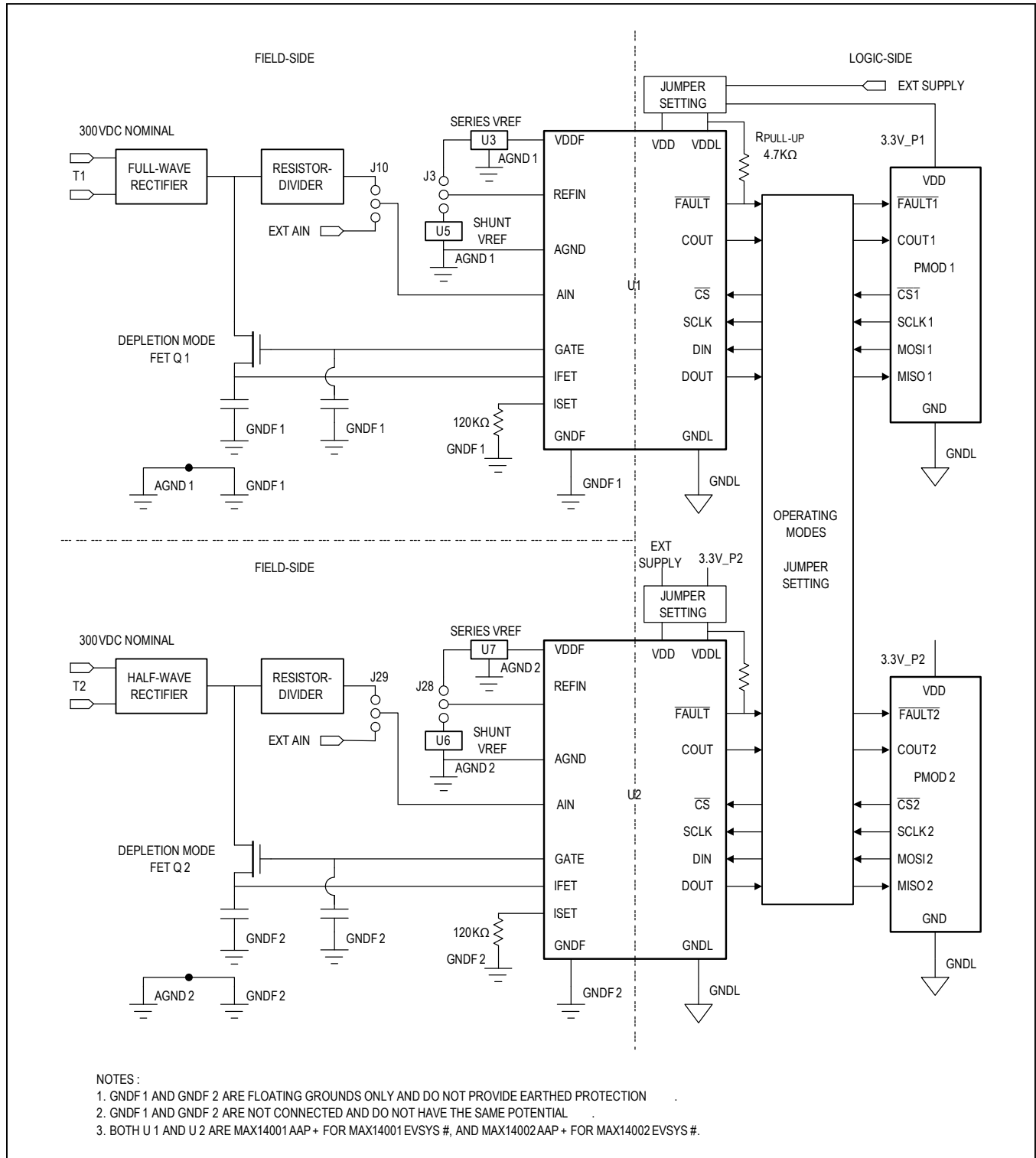

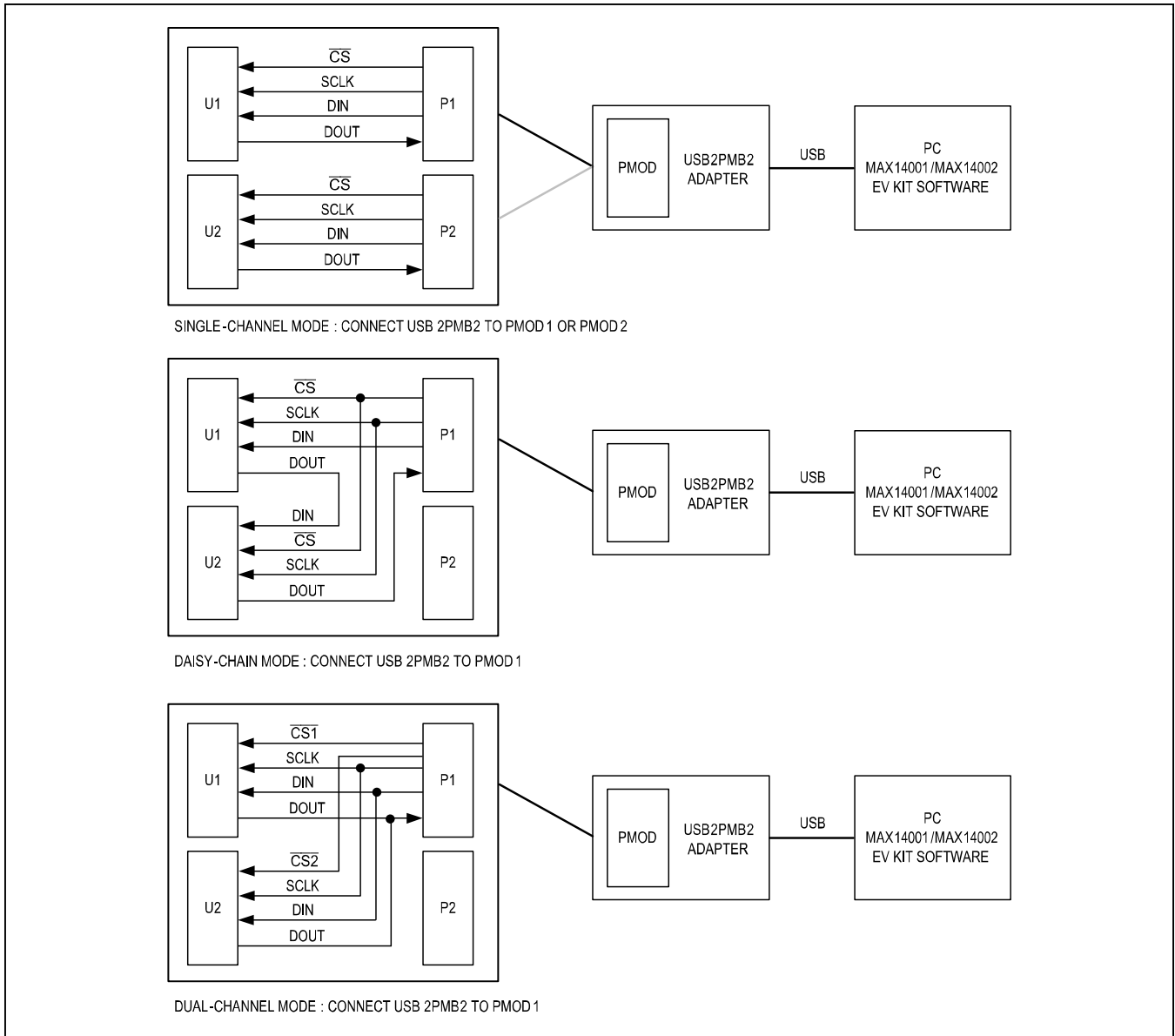

Figure 1: EV Kit Operating Modes

### MAX14001/14002 EV Kit Files

FILE	DESCRIPTION
MAX1400XEVKitSetupV1.0.ZIP	Application Program

# MAX14001/MAX14002 Evaluation System

Evaluates: MAX14001, MAX14002

## Quick Start

### Required Equipment

- MAX14001/MAX14002 EV kit
- USB2PMB2# adapter board
- Micro-USB cable
- DC voltage supply
- Windows XP®, Windows® 7, Windows 8.1, Windows 10 PC with a spare USB port

**Note:** In the following sections, software-related items are identified by bolding. Text in **bold** refers to items directly from the EV Kit software. Text in **bold and underline** refers to items from the Windows operating system.

### Procedure

The EV kit is fully assembled and tested. The default jumper settings configure the EV kit to operate in the single channel mode using U1. In this configuration, the EV kit is powered by +3.3V from USB2PMB2 adapter connected to PMOD1. U1 is operating in the internal reference mode with a resistor-divider in front of the ADC input, allowing 13.75VDC maximum voltage to be applied to V300\_13. Follow the steps below to verify MAX14001/MAX14002 operation:

- 1) Verify all jumper settings are in default position from [Table 1](#).
- 2) For initial testing, MAX14001/MAX14002 are powered from USB2PMB2 (+3.3V) from connector PMOD1.
- 3) Visit [www.maximintegrated.com/evkitsoftware](http://www.maximintegrated.com/evkitsoftware) to download the latest version of the EV kit software, MAX1400XEVKitSetupV1.0.ZIP.
- 4) Save the EV kit software to a temporary folder and uncompress the ZIP file.
- 5) Install the EV kit software and USB driver on your computer by running the MAX1400XEVKitSetupV1.0.exe program inside the temporary folder. A message box asking, **Do you want to allow the following program to make changes to this computer?** may appear. If so, click **Yes**.
- 6) The program files are copied to your PC and icons are created in the Windows **Start | Programs** menu. At the end of the installation process, the installer will launch the installer for the FTDI Chip CDM drivers.
- 7) The installer includes the drivers for the hardware and software. Follow the instructions on the installer and once complete, click **Finish**. The default location of the software is in the program files directory.
- 8) Connect the MAX14001/MAX14002 EV kit connector PMOD1 to the connector on the USB2PMB2 adapter.
- 9) Connect the USB2PMB2 to the PC with the Micro-USB cable. Windows should automatically recognize the device and display a message near the **System Icon** menu indicating that the hardware is ready to use. Observe that, on the EV kit, the 3.3V\_P1 LED (green LED) is on, indicating the hardware is powered up.
- 10) Once the hardware is ready to use, launch the EV kit software by opening its icon in the **Start | Programs** menu. The EV kit software appears as shown in [Figure 2](#).
- 11) From the **Device** menu, select **MAX14001** or **MAX14002** depending on whether MAX14001 EV kit or MAX14002 EV kit is connected to the PC. Verify that **U1** under **Single Channel** mode is selected from **Device Menu**.
- 12) From the **Device** menu, click **Connect to Hardware**. Then select a device in the list or use the default device already selected.
- 13) Verify that the lower-right status bar indicates the EV kit hardware is **Connected**.
- 14) Observe that after the connection, the FAULT1 LED (red LED) is turned off on the EV kit.
- 15) Connect the positive terminal of the DC supply to test point V300\_13 on the EV kit. Connect the negative terminal of the DC supply to test point GNDF1 on the EV kit.
- 16) Configure the DC supply output to be 7V. Enable the DC voltage supply.
- 17) In the **Configuration** tab of the EV kit software, change **U1 ADC Full Scale Voltage (V)** box to be 13.75V.
- 18) In the **ADC Scope** tab, click the **Start Sampling** button.
- 19) Observe that COUT1 LED (yellow LED) on the EV kit is turned on. The ADC scope graph on the EV kit software is showing 7V.

# MAX14001/MAX14002 Evaluation System

Evaluates: MAX14001, MAX14002

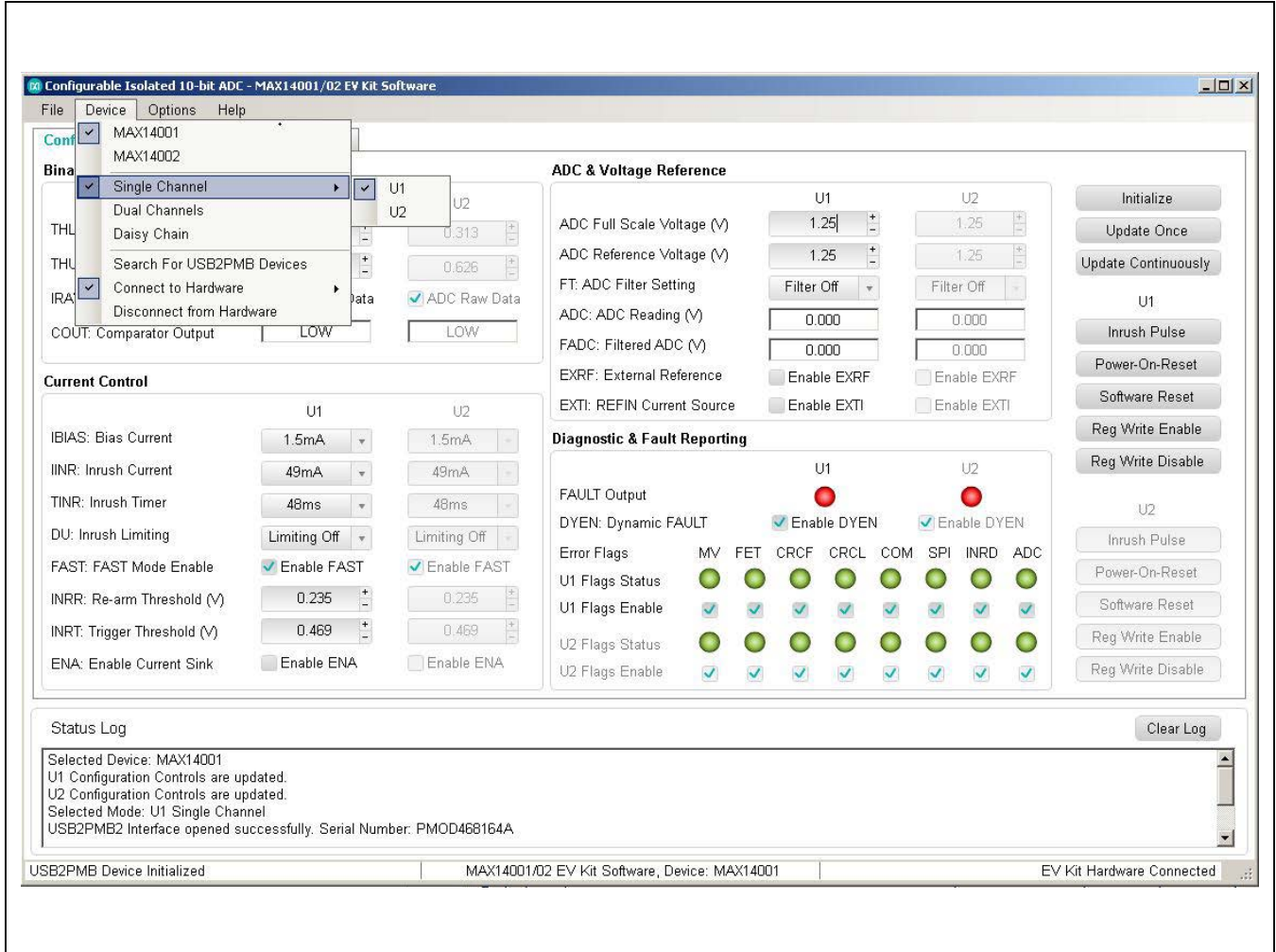

Figure 2. MAX14001/MAX14002 EV Kit Software Startup Window

**Table 1. MAX14001/MAX14002 EV Kit Jumper Settings**

JUMPER	SHUNT POSITION	DESCRIPTION
<b>U1 FIELD-SIDE</b>		
J4	<b>Closed*</b>	Connect full-wave rectification circuit to the voltage divider input, V300_13.
	Open	Disconnect full-wave rectification circuit from the voltage divider input, V300_13.
J2	<b>Closed*</b>	Connect V300_13 to the drain of power FET Q1.
	Open	Disconnect V300_13 from drain of power FET Q1.
J13	1 – 2	Use 1.25/300 voltage divider on V300_13 (300V, max).
	<b>2 – 3*</b>	Use 1.25/13.75 voltage divider on V300_13 (13.75V, max).
J10	1 – 2	Use external input AINEXT1 for U1 AIN.
	<b>2 – 3*</b>	Use voltage divider output for U1 AIN.
J1	Closed	Use U1 V <sub>DDF</sub> to power the series reference U3.
	<b>Open*</b>	Disconnect U1 V <sub>DDF</sub> from series reference U3.
J3	1 - 2	Use shunt reference U5 as U1 external voltage reference.
	2 - 3	Use series reference U3 as U1 external voltage reference.
	<b>Open*</b>	Use U1 internal reference.
<b>U2 FIELD-SIDE</b>		
J12	<b>Closed*</b>	Connect half-wave rectification circuit to the voltage divider input, V300_13_2.
	Open	Disconnect half-wave rectification circuit from the voltage divider input, V300_13_2.
J26	<b>Closed*</b>	Connect V300_13_2 to the drain of power FET Q2.
	Open	Disconnect V300_13_2 from drain of power FET Q2.
J30	1 – 2	Use 1.25/300 voltage divider on V300_13_2 (300V, max).
	<b>2 – 3*</b>	Use 1.25/13.75 voltage divider on V300_13_2 (13.75V, max).
J29	1 – 2	Use external input AINEXT2 for U2 AIN.
	<b>2 – 3*</b>	Use voltage divider output for U2 AIN.
J32	Closed	Use U2 V <sub>DDF</sub> to power the series reference U7.
	<b>Open*</b>	Disconnect U2 V <sub>DDF</sub> from series reference U7.
J28	1 - 2	Use shunt reference U6 as U2 external voltage reference.
	2 - 3	Use series reference U7 as U2 external voltage reference.
	<b>Open*</b>	Use U2 internal reference.
<b>POWER</b>		
J5	<b>1 - 2*</b>	U1 V <sub>DDL</sub> supply connects to 3.3V from PMOD1.
	2 - 3	Use external V <sub>DDL</sub> supply for U1. Connect external voltage to test point EXT_VDDL1.
J7	<b>1 - 2*</b>	U1 V <sub>DD</sub> supply connects to 3.3V from PMOD1.
	2 - 3	Use external V <sub>DD</sub> supply for U1. Connect external voltage to test point EXT_VDD1.
JMP1	<b>1 - 2*</b>	U2 V <sub>DDL</sub> supply connects to 3.3V from PMOD2.
	1 - 3	Use external V <sub>DDL</sub> supply for U2. Connect external voltage to test point EXT_VDDL2.
	1 - 4	U2 V <sub>DDL</sub> supply connects to 3.3V from PMOD1.



**Table 1. MAX14001/MAX14002 EV Kit Jumper Settings (continued)**

JUMPER	SHUNT POSITION	DESCRIPTION
JMP2	1 - 2*	U2 V <sub>DD</sub> supply connects to 3.3V from PMOD2.
	1 - 3	Use external V <sub>DD</sub> supply for U2. Connect external voltage to test point EXT_VDD2.
	1 - 4	U2 V <sub>DD</sub> supply connects to 3.3V from PMOD1.
<b>SPI INTERFACE</b>		
J8	Closed	Daisy-chain mode. Connect U1 DOUT to U2 DIN.
	Open*	U1 and U2 in single channel mode.
J21	1 - 2*	U1 in single channel mode or U1 and U2 in dual channel mode. U1 DOUT connects to PMOD1 pin 3, DOUT1_P. In dual channel mode, J14 should be closed to connect both U1 DOUT and U2 DOUT to PMOD1 pin 3, DOUT1_P.
	2 - 3	Daisy-chain mode. Connect U2 DOUT to PMOD1 pin 3, DOUT1_P.
J15	Closed	Daisy-chain mode. Connect U1 $\overline{CS}$ with U2 $\overline{CS}$ .
	Open*	U1 and U2 in single channel mode or dual channel mode.
J16	Closed	U1 and U2 in daisy-chain mode or dual channel mode. Connect U1 SCLK with U2 SCLK.
	Open*	U1 and U2 in single channel mode.
J6	1 - 2*	Single channel mode or daisy-chain mode. Connect U2 $\overline{FAULT}$ to PMOD1 pin 9, FAULT2_CS2.
	2 - 3	Dual channel mode. Connect U2 $\overline{CS}$ to PMOD1 pin 9, FAULT2_CS2.
J17	Closed	Dual channel mode. Connect U1 DIN with U2 DIN.
	Open*	U1 and U2 in single channel mode or daisy-chain mode.
J18	Closed	Dual channel mode. Connect U1 $\overline{FAULT}$ with U2 $\overline{FAULT}$ .
	Open*	U1 and U2 in single channel mode or daisy-chain mode.
J14	Closed	Dual channel mode. Connect U1 DOUT with U2 DOUT.
	Open*	U1 and U2 in single channel mode or daisy-chain mode.
<b>TEST POINTS (NEVER INSTALL JUMPERS)</b>		
J11	1,2, 15, 16	GNDL
	3	FAULT1 – U1 $\overline{FAULT}$ output
	4	FAULT2 – U2 $\overline{FAULT}$ output
	5	COU1 – U1 COU output
	6	COU2 – U2 COU output
	7	$\overline{CS1}$ – U1 Chip Select
	8	$\overline{CS2}$ – U2 Chip Select
	9	SCLK1 – U1 Serial Clock
	10	SCLK2 – U2 Serial Clock
	11	DIN1 – U1 MOSI
	12	DIN2 – U2 MOSI
	13	DOUT1 – U1 MISO
	14	DOUT2 – U2 MISO

\*Default position.

**Note:** In daisy-chain and dual-channel modes, only PMOD1 is connected to USB2PMB2 adapter board.

**Table 2. MAX14001/MAX14002 EV Kit Jumper Settings for Operating Modes**

JUMPER	SINGLE CHANNEL* (PMOD1)	SINGLE CHANNEL (PMOD2)	DAISY CHAIN (PMOD1)	DUAL CHANNEL (PMOD1)
J8	Open	Open	<b>Closed</b>	Open
J21	<b>1 - 2</b>	Open	<b>2 - 3</b>	<b>1 - 2</b>
J15	Open	Open	<b>Closed</b>	Open
J16	Open	Open	<b>Closed</b>	<b>Closed</b>
J6	<b>1 - 2</b>	Open	<b>1 - 2</b>	<b>2 - 3</b>
J17	Open	Open	Open	<b>Closed</b>
J18	Open	Open	Open	<b>Closed</b>
J14	Open	Open	Open	<b>Closed</b>

\*Default position.

## Detailed Description of Software

The main window of the EV kit software contains three tabs: **Configuration**, **ADC Scope**, and **Register Map**. The **Configuration** tab provides the controls to directly configure MAX14001/MAX14002 features such as comparator thresholds, inrush current magnitude and duration, fault status reporting, etc. The **ADC Scope** tab plots the ADC readings and filtered ADC readings in the time domain graph. The **Register Map** tab lists all registers in the MAX14001/MAX14002 and provides direct read and write access to all the control bits.

The MAX14001/MAX14002 EV kit software can work with both MAX14001EVKIT# and MAX14002EVKIT#. The **Device** menu allows the user to select the device, the operating mode, and to connect or disconnect to the hardware by choosing detected USB2PMB2 serial numbers.

## Configuration Tab

The **Configuration** tab provides an interface for configuring the MAX14001/MAX14002 from a functional perspective. The main block provides the controls for comparator thresholds configuration, bias current magnitude, inrush current magnitude and duration configuration, FAST mode enable, inrush current re-arm and trigger thresholds configuration, ADC full scale voltage setting, ADC filter setting, ADC reference options,  $\overline{\text{FAULT}}$  pin configuration, flags status reporting, etc. The **Initialize** button reads the MAX14001/MAX14002 registers and refresh all the controls with current setting. The **Update Once** and **Update Continuously** buttons read  $\overline{\text{ADC}}$ ,  $\overline{\text{FADC}}$ , and  $\overline{\text{FLAGS}}$  registers value, poll  $\overline{\text{COUT}}$  and  $\overline{\text{FAULT}}$  pin status and update the corresponding controls. The **Inrush Pulse**, **Power-On-Reset** and **Software Reset** buttons write to the ACT register. The **Reg Write Enable** and **Reg Write Disable** buttons write to the Write Enable register.

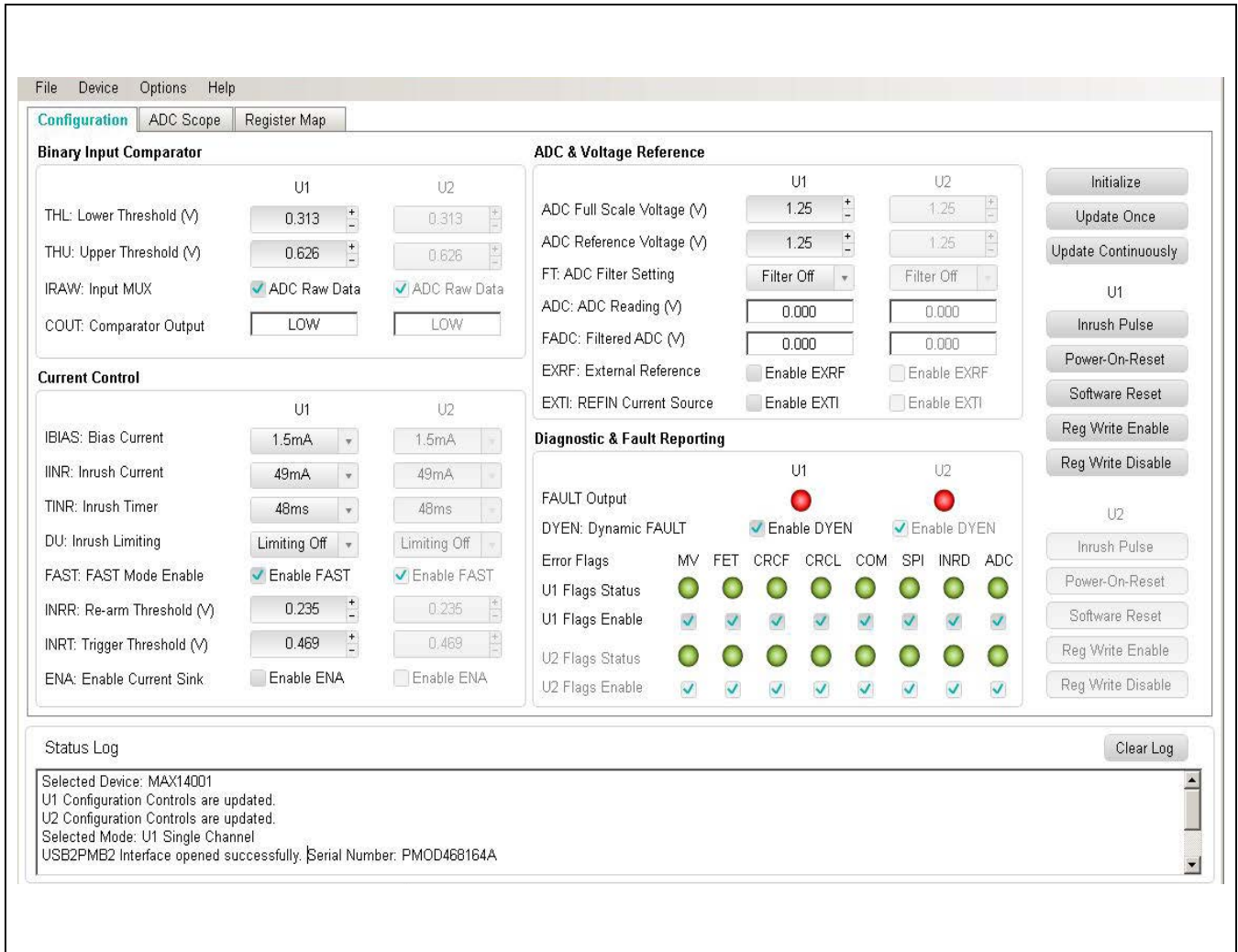

Figure 3. EV Kit Software (Configuration Tab)

### ADC Scope Tab

The **ADC Scope** tab is used to display the ADC readings and filtered ADC readings in the time domain graph. By clicking the **Start Sampling** button, the software will keep reading the ADC register and/or the Filtered ADC register and display the results continuously. Click the same button to stop sampling.

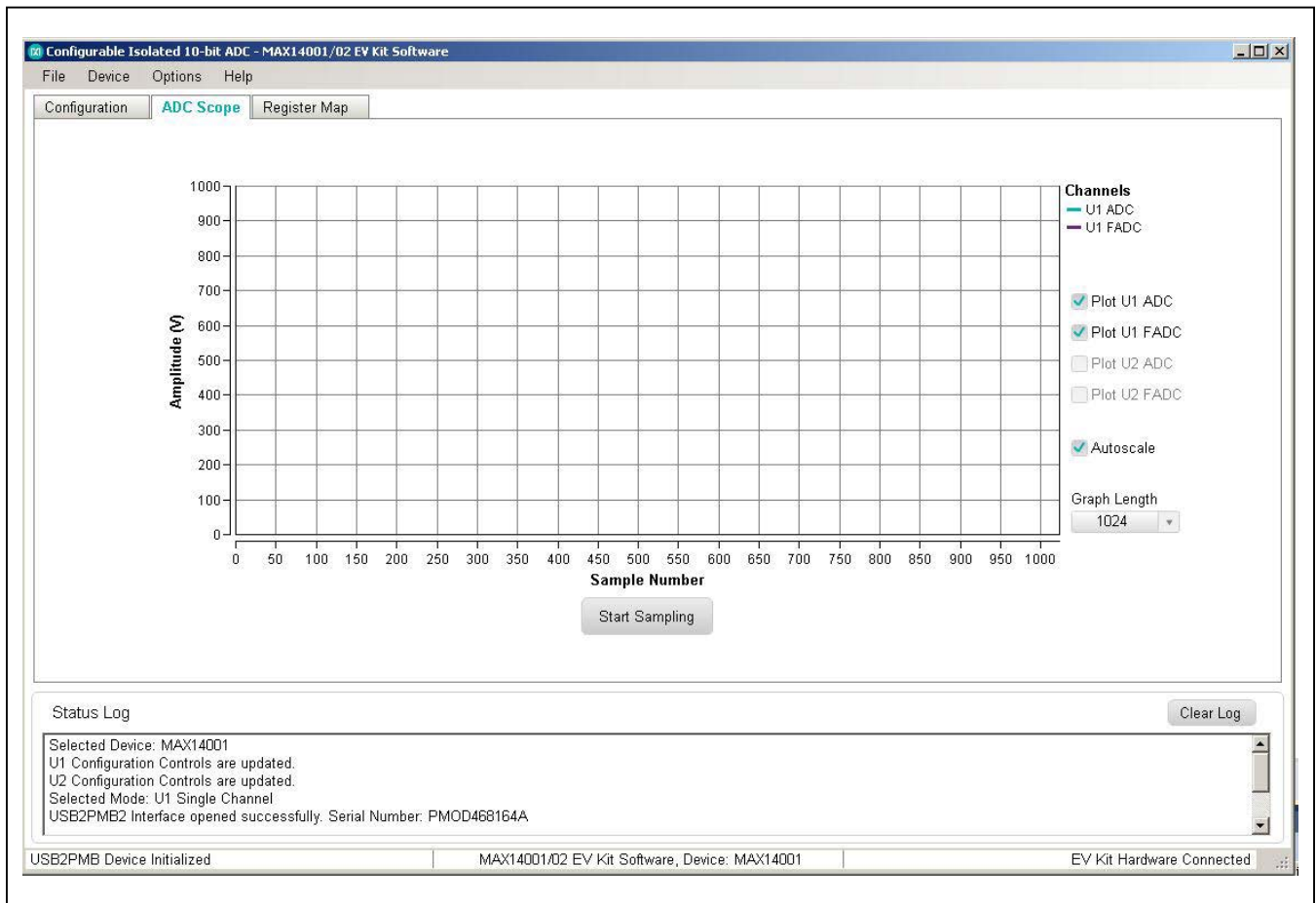

Figure 4. EV Kit Software (ADC Scope Tab)

### Register Map Tab

The **Register Map** tab shows all MAX14001/MAX14002 registers information including the register name, address, value, read or write accessibility, and the register description. The **Value** cell can be changed by user if the register is writable. By pressing the **Enter** key after changing the **Value** will write to the register. When certain register is highlighted in the register list, the bits' information in this register will be displayed in the **Bits Description** table. The bit **Setting** is configurable if the bit is writable, which will trigger a write operation to its register.

Clicking the **Read All** button reads all registers and refresh the window with register settings. Clicking the **Write All** button writes the current settings to all registers.

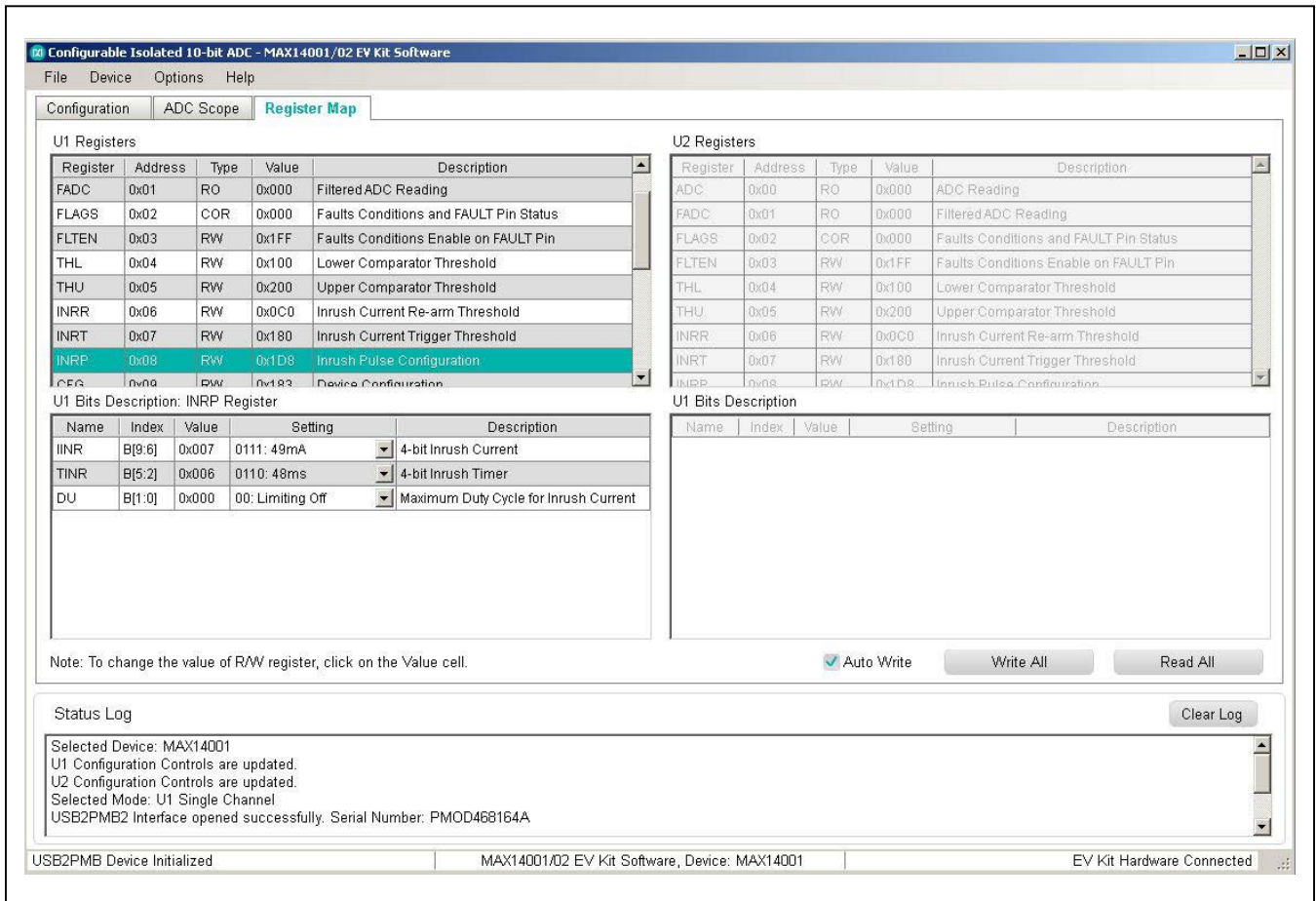

Figure 5. EV Kit Software (Register Map Tab)

## Detailed Description of Hardware

The MAX14001/MAX14002 EV kit provides a proven layout for the IC and has options to select input signal conditioning, voltage reference source, as well as SPI interface operating modes. Two channels are included with flexibility for operating modes making it easier to evaluate system performance of the MAX14001/MAX14002. A full-wave rectified input is an option for device U1 and a half-wave rectified input is an option for device U2.

### SPI Interface

The EV kit software communicates over USB to the SPI interface and supports full 5MHz clock rate for the MAX14001/MAX14002. The SPI interface can communicate to a single device, or both devices can be daisy-chained. Three SPI operation modes are supported by the EV kit: single channel mode, Dual Channel mode and daisy-chain mode. [Table 2](#) describes how to configure the EV kit jumpers to operate in different operating modes. The EV kit uses standard Pmod-compatible 12-pin headers to connect to an external adapter board (USB2PMB2) which provides an interface to a PC with a USB port. If the users wish to interface to their own Microcontroller or FPGA, simply hardware the SPI signals to the Pmod connectors or J11.

### Power Supplies

The EV kit is powered entirely from USB supplied power or using external low-voltage supplies. The USB2PMB2 adapter board converts the USB 5V supply to a regulated +3.3V supply, which powers the EV kit. Alternatively, connect +1.71 to +5.5V external supplies to test points EXT\_VDDL1 and/or EXT\_VDDL2, and connect +3.0 to +3.6V external supplies to test points EXT\_VDD1 and/or EXT\_VDD2.

### Voltage Reference

The MAX14001/MAX14002 can use its internal 1.25V reference, or an external series or shunt 1.25V reference. The option for external vs. internal reference and the type of external reference is selectable using the GUI, which programs bits EXRF and EXTI in the Configuration (CFG)

register, as shown in [Table 3](#). On the EV kit hardware, J3 and J28 should be configured accordingly before switching between internal reference and external series or shunt reference (see [Table 1](#) for jumper setting details).

### External Shunt Voltage Reference Configuration

The EXRF bit (bit 5) in the CFG register (0x09) is set to “1” to switch to the external reference mode and the EXTI (bit 4) in the CFG register (0x09) is set to “1” to turn on the internal current source. The shunt reference (U5 or U6) is connected between the REFIN pin and AGND. Since the current source can supply up to 70µA, the shunt reference must have an operating current of 70µA or lower. Refer to [Table 4](#) for a recommended voltage reference with operating temperature of -40°C to 125°C to match the MAX14001/MAX14002 operating temperature.

### External Series Voltage Reference Configuration

The EXRF bit (bit 5) in the CFG register (0x09) is set to “1” to turn on the external reference mode and the EXTI (bit 4) in the CFG register (0x09) is set to “0” since no current source is required for a series reference.  $V_{DDF}$  is used to supply the series reference (U3 or U7) input, and the output is connected to the REFIN pin. Since  $V_{DDF}$  can supply up to 70µA current, the series reference must have a maximum operating current of 70µA or lower. Refer to [Table 4](#) for a recommended voltage reference with operating temperature of -40°C to 125°C to match the MAX14001/MAX14002 operating temperature.

### Input Filters and Rectifiers

The typical application for the MAX14001/MAX14002 is monitoring high-voltage DC signals, such as configurable binary inputs modules. A full-wave rectification filter (for U1) and a half-wave rectification filter (for U2) are implemented on the ADC input AIN front-end to help demonstrate the typical application. The filter is designed to accept a 300VDC maximum input voltage at T1 or T2 and, after the filter, the signal is further attenuated by the resistor-divider to provide 1.25V maximum at the ADC input AIN. The users may change the filter circuit components as needed to fit in their own applications.

**Table 3. Voltage Reference Settings**

REFERENCE CONFIGURATION	CFG:EXRF	CFG:EXTI	CONNECTION
Internal Reference	0	0	Connect REFIN directly to AGND.
External Series Reference	1	0	Series reference is supplied by $V_{DDF}$ . Output is connected to the REFIN pin. Bypass REFIN to AGND with a 0.1µF capacitor.
External Shunt Reference	1	1	Internal current source is turned on. Shunt reference is connected between REFIN and AGND. Bypass REFIN to AGND with a 0.1µF capacitor.

**Table 4. Recommended Voltage References**

PART NUMBER	VENDOR	TYPE
MAX6006	Maxim Integrated	Shunt Reference
LM4041	Maxim Integrated	Shunt Reference
LM4051	Maxim Integrated	Shunt Reference
REF3312	Texas Instruments	Series Reference
REF3012	Texas Instruments	Series Reference

For high-voltage applications, it is recommended to use XY rated safety capacitors on C9, C22, C24, and C40 (not installed) on the filter circuits. It is also recommended to install C44 and C45 for applications that involve high-voltage surges or bursts.

#### ADC Input (AIN) Resistor Divider

An external high voltage needs to be divided down to meet the ADC full-scale range, and to compare this input to user-configured comparator lower and upper thresholds, and inrush re-arm and trigger thresholds. **The absolute maximum voltage for the ADC input is -0.3V to +2V and the user must ensure that any external voltage applied to the EV kit does not cause this range to be exceeded at the AIN pin of the target device.**

By configuring jumpers J13 and J10 (for U1) or J30 and J29 (for U2), the EV kit can support three different input sources to the ADC input AIN:

- 1) Direct Mode (J10, J29 in position 1-2): Connect the input voltage at test point or SMA connector AINEXT1 (for U1) or AINEXT2 (for U2). If this option is used, care must be exercised to limit the voltage at AINEXT\_ to a range of -0.3V to +2V. Exceeding this range could permanently damage the IC. Direct mode excludes the depletion mode FET from the input circuit, removing all inrush and bias currents.
- 2) Safe Voltage Simulation Mode (Default Mode) (J10, J29 in position 2-3, and J13, J30 in position 2-3): This mode allows the features of the MAX14001/MAX14002 to be tested without the use of hazardous voltages. The input voltage (13.75VDC full-scale) is connected to test point V300\_13 (for U1) or V300\_13\_2 (for U2), and is scaled by MELF resistors R4 and R22 (for U1) or R25 and R37 (for U2) providing up to 1.25V at the ADC input. The external FET may be connected by installing J2 (for U1) and J26 (for U2), which makes the inrush and bias current features available.
- 3) High-Voltage Mode (J10, J29 in position 2-3, and J13, J30 in position 1-2, and J4, J12 closed): This mode

allows the system to be used in real applications that frequently have hazardous input voltages. **The user should be aware of the hazards associated with these voltages and know that applying hazardous voltages to the circuit could cause any of the associated test points or circuit traces to have a hazardous potential.** The input voltage is connected to, polarity independent, terminal block T1 (full-wave rectification circuit) or, polarity protected, terminal block T2 (half-wave rectification circuit), and is scaled by MELF resistors R1, R2, R3, and R4 (for U1) or R9, R24, R26, and R37 (for U2) providing up to 1.25V at the ADC input when 300VDC is applied to T1 or T2.

#### Ordering Information

PART	TYPE
MAX14001EVSYS#	EV System
MAX14002EVSYS#	EV System

*#Denotes RoHS compliant.*

*The MAX14001EVSYS# includes the MAX14001EVKIT# and USB2PMB2#.*

*The MAX14002EVSYS# includes the MAX14002EVKIT# and USB2PMB2#.*

# MAX14001/MAX14002 Evaluation System

Evaluates: MAX14001, MAX14002

## MAX14001 Bill of Materials

ITEM	REF_DES	DNI/DNP	QTY	MFG PART #	MANUFACTURER	VALUE	DESCRIPTION
1	VM1, VIN2, AINEXT1, AINEXT2, V300_13, FLT1_IN, FLT1_OUT, FLT2_IN, FLT2_OUT, V300_13_2	-	10	5014	KEYSTONE	N/A	TEST POINT; PIN DIA=0.125IN; TO TAL LENGTH=0.446IN; BOARD HOLE=0.063IN; YELLOW; PHOSPHOR BRONZE WIRE SILVER PLATE FINISH;
2	C1	-	1	BFC233660103	VISHAY BCCOMPONENTS	0.01UF	CAPACITOR; THROUGH HOLE-RADIAL LEAD; POLYPROPYLENE; 0.01UF; 300V; TOL=20%; TG=55 DEGC TO +105 DEGC; AUTO
3	C2, C8, C10, C11, C25, C26, C31, C34	-	8	GRM188R7A102K401; C1608X7R2A102K	MURATA; TDK	1000PF	CAPACITOR; SMT (0603); CERAMIC CHIP; 1000PF; 100V; TOL=0%; MODEL=GRM SERIES; TG=55 DEGC TO +125 DEGC; TC=X7R
4	C3, C29	-	2	CGA8E2X7R2A103K; C0603C103K1P8A	TDK/KEMET/AVX	0.01UF	CAPACITOR; SMT (0603); CERAMIC CHIP; 0.01UF; 100V; TOL=10%; MODEL=X7R; TG=55 DEGC TO +125 DEGC; TC= USE 20-00-01-M8
5	C4	-	1	F339X134733MFP2B0	VISHAY BCCOMPONENTS	0.047UF	CAPACITOR; THROUGH HOLE-RADIAL LEAD; POLYPROPYLENE; 0.047UF; 330V; TOL=20%
6	C5, C6, C13, C30, C32, C37	-	6	GRM188R7A104K435; C0603KRX7R06B104	MURATA; TDK	0.1UF	CAPACITOR; SMT (0603); CERAMIC CHIP; 0.1UF; 100V; TOL=10%; TG=55 DEGC TO +125 DEGC; TC=X7R
7	C7, C18, C33, C43	-	4	C1608X7R1V105K800AC	TDK	1UF	CAPACITOR; SMT (0603); CERAMIC CHIP; 1UF; 35V; TOL=10%; TG=55 DEGC TO +125 DEGC; TC=X7R
8	C14, C15, C35, C36	-	4	CL21B106K00NNN	SAMSUNG ELECTRONICS	10UF	CAPACITOR; SMT (0805); CERAMIC CHIP; 10UF; 16V; TOL=10%; TG=55 DEGC TO +125 DEGC; TC=X7R
9	C21	-	1	C921U222M1VDBA	KEMET	2200PF	CAPACITOR; THROUGH HOLE-RADIAL LEAD; CERAMIC; 2200PF; 400V; TOL=20%; TG=40 DEGC TO +125 DEGC; TC=Y5V
10	D1, D2	-	2	1.6SMC400CA	LITTELFUSE	342V	DIODE; TVS; SMT; VRM=342V; IPP=2.8A
11	D3, D4	-	2	BYG20J.E3	VISHAY GENERAL SEMICONDUCTOR	BYG20J.E3	DIODE; RECT; SMA (DC-2144C); PIV=600V; IF=1.5A
12	DS3, DS4	-	2	LTST-C191KSKT	LITE-ON ELECTRONICS INC.	LTST-C191KSKT	DIODE; LED; SMD; LED; YELLOW; SMT (0603); VF=2.1V; IF=0.02A
13	DS5, DS6	-	2	LTST-C191KSKT	LITE-ON ELECTRONICS INC.	LTST-C191KSKT	DIODE; LED; SMD; LED; GREEN; SMT (0603); VF=2.15V; IF=0.02A
14	DS7, DS8	-	2	LTST-C191KRKT	LITE-ON ELECTRONICS INC.	LTST-C191KRKT	DIODE; LED; SMD; LED; RED; SMT (0603); VF=2V; IF=0.02A
15	VDD1, VDD2, VDDF1, VDDF2, VDD1_1, VDD1_2, VREF1, VREF2, EXT_VDD1, EXT_VDD2, EXT_VDD1_1, EXT_VDD1_2	-	12	5010	?	5010	TESTPOINT WITH 1.80MM HOLE DIA. RED. MULTIPURPOSE
16	GND1, GATE1, GATE2, GNDF1, GNDF2, ISET1, ISET2, GND1_1, GND1_2, GND1_3, GND1_4, GND1_5, GND1_6, GND1_7, GND1_8, GND1_9, GND1_10, GND1_11, GND1_12, GND1_13, GND1_14, GND1_15, GND1_16, GND1_17, GND1_18, GND1_19, GND1_20, GND1_21	-	10	5011	?	5011	TEST POINT; PIN DIA=0.125IN; TOTAL LENGTH=0.446IN; BOARD HOLE=0.063IN; BLACK; PHOSPHOR BRONZE WIRE SILVER PLATE FINISH;
17	J1, J6, J14, J18, J32	-	8	PEC02SAAN	SULLINS	PEC02SAAN	CONNECTOR; MALE; THROUGH HOLE; BREAKAWAY; STRAIGHT; 2PINS
18	J2, J4, J12, J26	-	4	TSW-202-23-G-S	SAMTEC	TSW-202-23-G-S	CONNECTOR; MALE; THROUGH HOLE; POST TERMINAL STRIP ASSEMBLY; STRAIGHT; 2PINS
19	J3, J5, J7, J10, J21, J28, J29	-	8	PEC03SAAN	SULLINS	PEC03SAAN	CONNECTOR; MALE; THROUGH HOLE; BREAKAWAY; STRAIGHT; 3PINS
20	J11	-	1	PEC08DAAN	SULLINS ELECTRONICS CORP.	PEC08DAAN	CONNECTOR; MALE; THROUGH HOLE; BREAKAWAY; STRAIGHT; 16PINS; 45 DEGC TO +125 DEGC
21	J13, J30	-	2	TSW-203-23-G-S	SAMTEC	TSW-203-23-G-S	CONNECTOR; MALE; THROUGH HOLE; POST TERMINAL STRIP ASSEMBLY; STRAIGHT; 3PINS
22	J27, SMA4	-	2	142-0711-826	JOHNSON COMPONENTS	142-0711-826	CONNECTOR; FEMALE; BOARD MOUNT; END LAUNCH JACK ASSEMBLY; NICKLE PLATED; STRAIGHT; 2PINS
23	JMP1, JMP2	-	2	PEC04SAAN	SULLINS ELECTRONICS CORP.	PEC04SAAN	CONNECTOR; MALE; THROUGH HOLE; BREAKAWAY; STRAIGHT; 4PINS
24	L1, L2	-	2	ASPI-1040H-100M	ABRACON	10UH	INDUCTOR; SMT; WIRE WOUND CHIP; 10UH; TOL=#+20%; 7.5A
25	PMOD1, PMOD2	-	2	TSW-106-08-S-D-RA	SAMTEC	TSW-106-08-S-D-RA	CONNECTOR; THROUGH HOLE; DOUBLE ROW; RIGHT ANGLE; 12PINS;
26	Q1, Q2	-	2	IXTY08N100D2	IXYS CORPORATION	IXTY08N100D2	TRAN; N-CHANNEL DEPLETION MODE MOSFET; NCH; TO-252AA; PD(0.06W); I(0.8A); V(1000V)
27	Q4, Q5	-	2	MMBT3904LT1G	ON SEMICONDUCTOR	MMBT3904LT1G	TRAN; GENERAL PURPOSE TRANSISTOR; NPN; SOT-23; PD(0.3W); I(0.2A); V(40V)
28	Q6, Q7	-	2	MMBT3906-7-F	DIODES INCORPORATED	MMBT3906-7-F	TRAN; 40V PNP SMALL SIGNAL TRANSISTOR; PNP; SOT-23; PD(0.31W); I(-0.2A); V(-40V)



# MAX14001/MAX14002 Evaluation System

Evaluates: MAX14001, MAX14002

## MAX14001 Bill of Materials (continued)

ITEM	REF_DES	DNI/DNP	QTY	MFG PART #	MANUFACTURER	VALUE	DESCRIPTION
29	R1, R9	-	2	MMB0207MC7503FB200	VISHAY BEYSCHLAG	750K	RESISTOR; SMT; 750K OHM; 1%; 50PPM; 1W; THIN FILM
30	R2, R3, R24, R26	-	4	MMB0207MC9203FB200	VISHAY BEYSCHLAG	820K	RESISTOR; SMT; 820K OHM; 1%; 50PPM; 1W; THIN FILM
31	R4, R37	-	2	MMB0207C1002FB200	VISHAY BEYSCHLAG	10K	RESISTOR; SMT; 10K OHM; 1%; 50PPM; 1W; THIN FILM
32	R5, R6	-	2	MMB0207C1009FB200	VISHAY BEYSCHLAG	10	RESISTOR; SMT; 10 OHM; 1%; 50PPM; 1W; THIN FILM
33	R7, R39	-	2	ERJ2RKF1000X	PANASONIC	100	RESISTOR; 0402; 100 OHM; 1%; 100PPM; 0.10W; THICK FILM
34	R8, R38	-	2	CFP0402B120KE	TE CONNECTIVITY	120K	RESISTOR; 0402; 120K OHM; 0.1%; 25PPM; 0.063W; THIN FILM
35	R10-R14, R16-R21, R40-R42, R44-R49	-	20	CRCW0402020002S	VISHAY DALE	0	RESISTOR; 0402; 0 OHM; 0%; JUMPER; 0.063W; THICK FILM
36	R15, R43	-	2	ERJ2RKF4701	PANASONIC	4.7K	RESISTOR; 0402; 4.7K OHM; 1%; 100PPM; 0.10W; THICK FILM
37	R22, R23, R25	-	3	MMB0207C1003FB200	VISHAY BEYSCHLAG	100K	RESISTOR; SMT; 100K OHM; 1%; 50PPM; 1W; THIN FILM
38	R27, R28, R32, R33	-	4	ERJ2RKF1202	PANASONIC	12K	RESISTOR; 0402; 12K OHM; 1%; 100PPM; 0.1W; THICK FILM
39	R29, R30, R35, R36	-	4	ERJ2RKF2400	PANASONIC	240	RESISTOR; 0402; 240 OHM; 1%; 100PPM; 0.10W; THICK FILM
40	R31, R34	-	2	CRCW0402470RFB200	VISHAY DRALORIC	470	RESISTOR; 0402; 470 OHM; 1%; 100PPM; 0.125W; THICK FILM
41	SU1-SU6	-	6	5312304	TE CONNECTIVITY	5312304	TEST POINT; ECONOMY SHUNT ASSEMBLY; STR; TOTAL LENGTH=0.256IN; BLACK; TOTAL LENGTH=2IN; BLACK CONTACT BASE MATERIAL= BERYLLIUM COPPER
42	SU7-SU24	-	18	STC0202SYAN	SULLINS ELECTRONICS CORP.	STC0202SYAN	TEST POINT; JUMPER; STR; TOTAL LENGTH=0.256IN; BLACK; INSULATION=HBT CONTACT=PHOSPHOR BRONZE; COPPER PLATED TIN OVERALL
43	T1, T2	-	2	1714871	PHOENIX CONTACT	1714871	CONNECTOR; FEMALE; THROUGH HOLE; PCB TERMINAL BLOCK; RIGHT ANGLE; 2PINS
44	U1, U2	-	2	MAX14001	MAXIM	MAX14001	EVKIT PART - IC; MAX14001; CONFIGURABLE; ISOLATED 10-BIT ADCS FOR MULTIRANGE BINARY INPUT; PACKAGE OUTLINE DEVICE: 21-0056; PACKAGE CODE: A20MS-6
45	U3, U7	-	2	REF3312AIDBZT	TEXAS INSTRUMENTS	REF3312AIDBZT	IC; VREF; REF3312 30-PPM/DEGC DRIFT VOLTAGE REFERENCE; SOT23
46	U4	-	1	DF08SAE3	VISHAY GENERAL SEMICONDUCTOR	DF08SAE3	DIODE; RECT; SMT; PIV=1.1V; IF=1A
47	U5, U6	-	2	MAX6006BAUR+	MAXIM	MAX6006BAUR+	EVKIT PART-IC; VREF; MICROAMP SOT23 PRECISION SHUNT VOLTAGE REFERENCE; 1.25VOUT
48	C9, C22, C24, C40	DNI	4	C921U222MVDDBA	KEMET	2200PF	CAPACITOR; THROUGH-HOLE-RADIAL LEAD; CERAMIC; 2200PF; 40V; TOL=10%; TG=-55 DEGC TO +125 DEGC; TC=X7R
49	C12, C38	DNI	2	UMK107AB7108KA	TAIYO YUDEN	1UF	CAPACITOR; SMT (0402); CERAMIC CHIP; 47PF; 50V; TOL=5%; MODEL=; TG=-55 DEGC TO +125 DEGC; TC=C0G
50	C16, C17, C19, C20, C27, C39, C41, C42	DNI	8	C0402C0G500-770JNE; C0402JRNPO8BNA70; GRM1555C1H20A01	VENKEL LTD/ YAGEO PHYCOMP/MURATA	47PF	CAPACITOR; SMT (0402); CERAMIC CHIP; 47PF; 50V; TOL=5%; MODEL=HT SERIES; TG=-55 DEGC TO +200 DEGC; TC=C0G
51	C23, C28	DNI	2	C0402H102J6CAC	KEMET	1000PF	CAPACITOR; SMT (0402); CERAMIC CHIP; 1000PF; 50V; TOL=10%; TG=-40 DEGC TO +125 DEGC; TC=Y5S
52	C44, C45	DNI	2	VY1101K31Y5S063V0	VISHAY BC COMPONENTS	100PF	CAPACITOR; THROUGH-HOLE-RADIAL LEAD; CERAMIC; 100PF; 680V; TOL=10%; TG=-40 DEGC TO +125 DEGC; TC=Y5S
53	PCB	-	1	MAX14001	MAXIM	PCB	PCB Board MAX14001 EVALUATION KIT
TOTAL			207				

MAX14001/MAX14002 Schematics

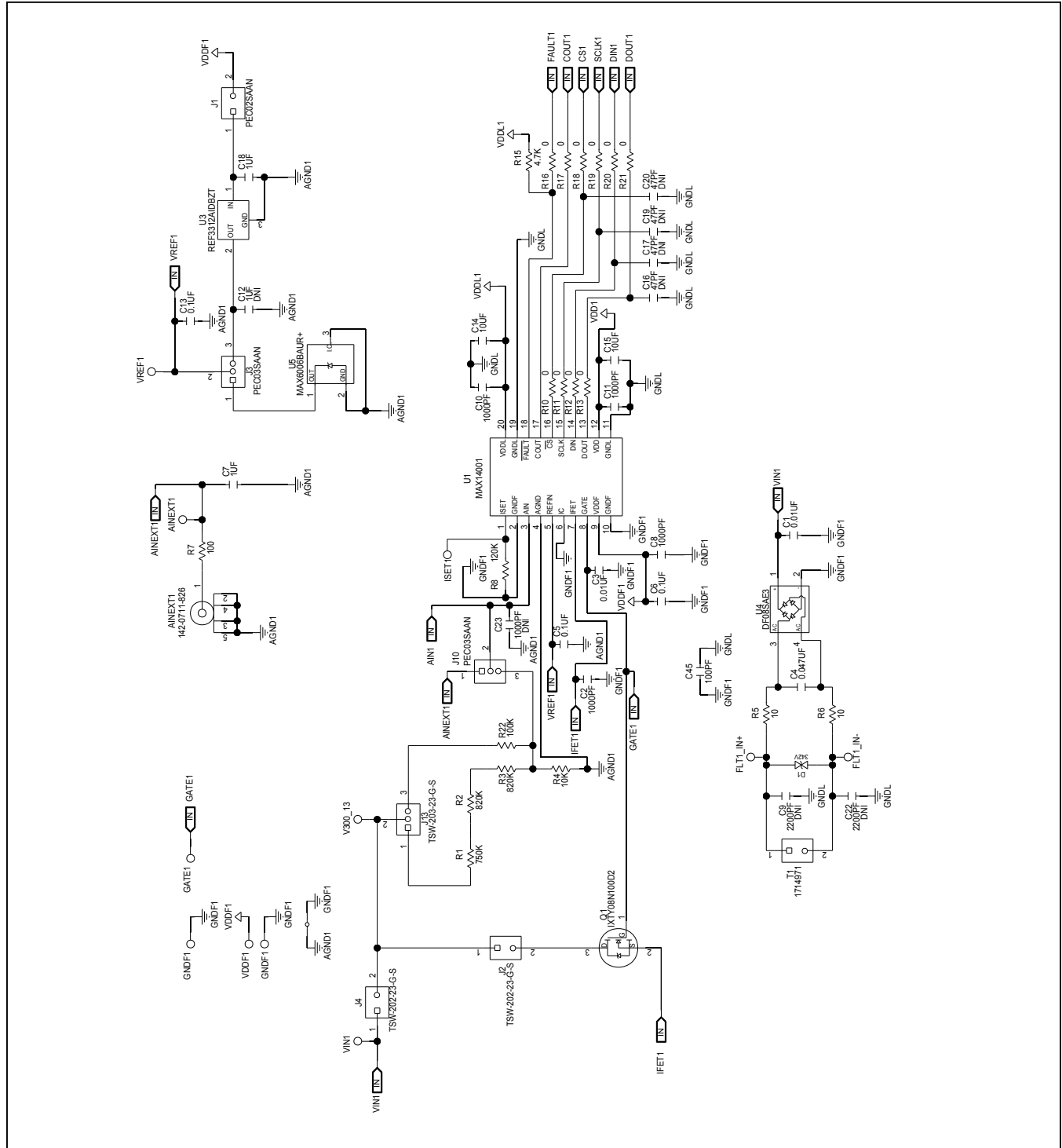

**CAUTION:** GND1 and GND2 are common nodes only. They do not provide earthed protection from hazardous voltages. If a hazardous voltage is applied to the field-side circuit, any point in the field-side circuit, including GND1 or GND2, may have a hazardous voltage.

MAX14001/MAX14002 Schematics (continued)

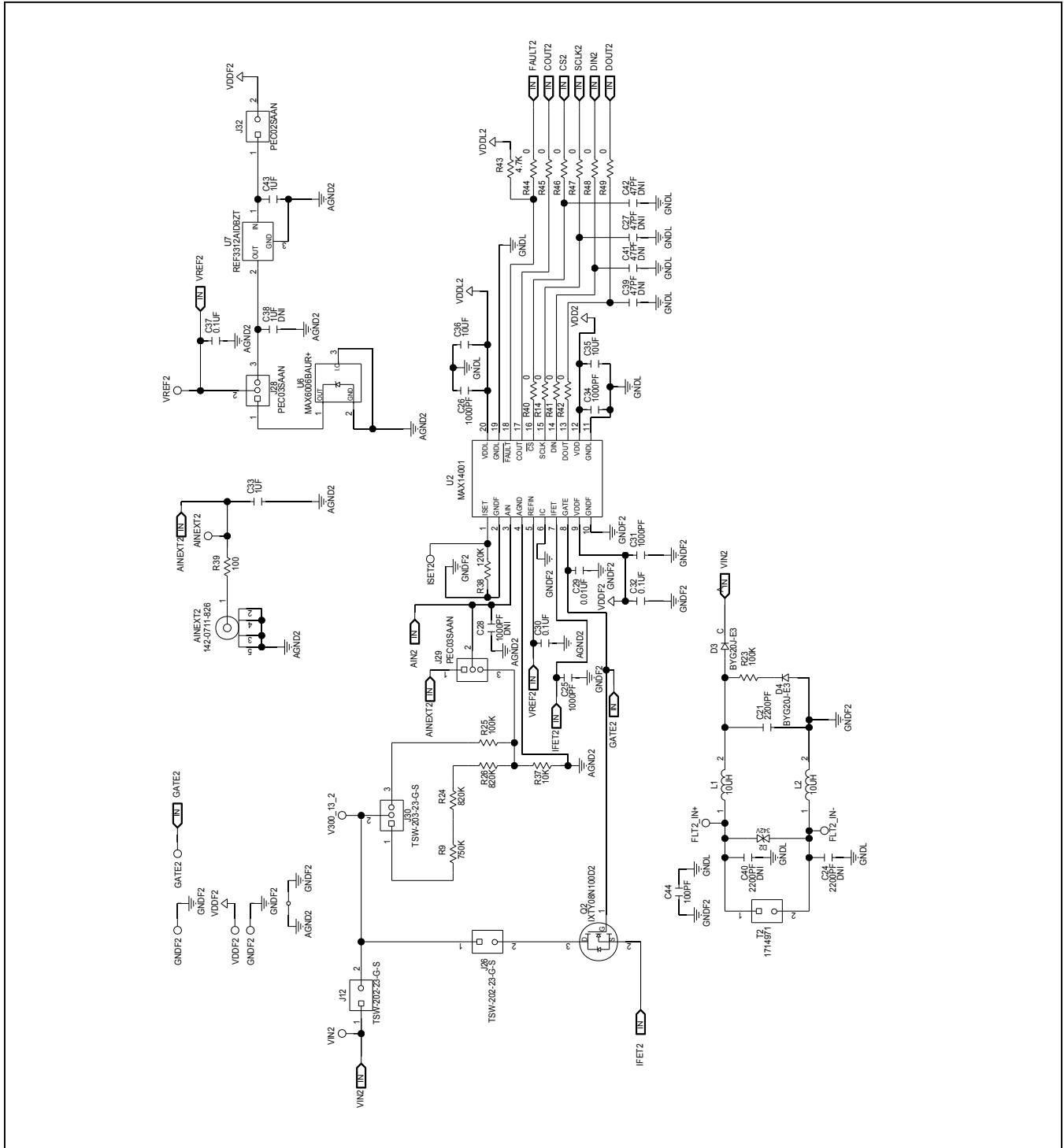

**CAUTION:** GND<sub>F1</sub> and GND<sub>F2</sub> are common nodes only. They do not provide earthed protection from hazardous voltages. If a hazardous voltage is applied to the field-side circuit, any point in the field-side circuit, including GND<sub>F1</sub> or GND<sub>F2</sub>, may have a hazardous voltage.

MAX14001/MAX14002 Schematics (continued)

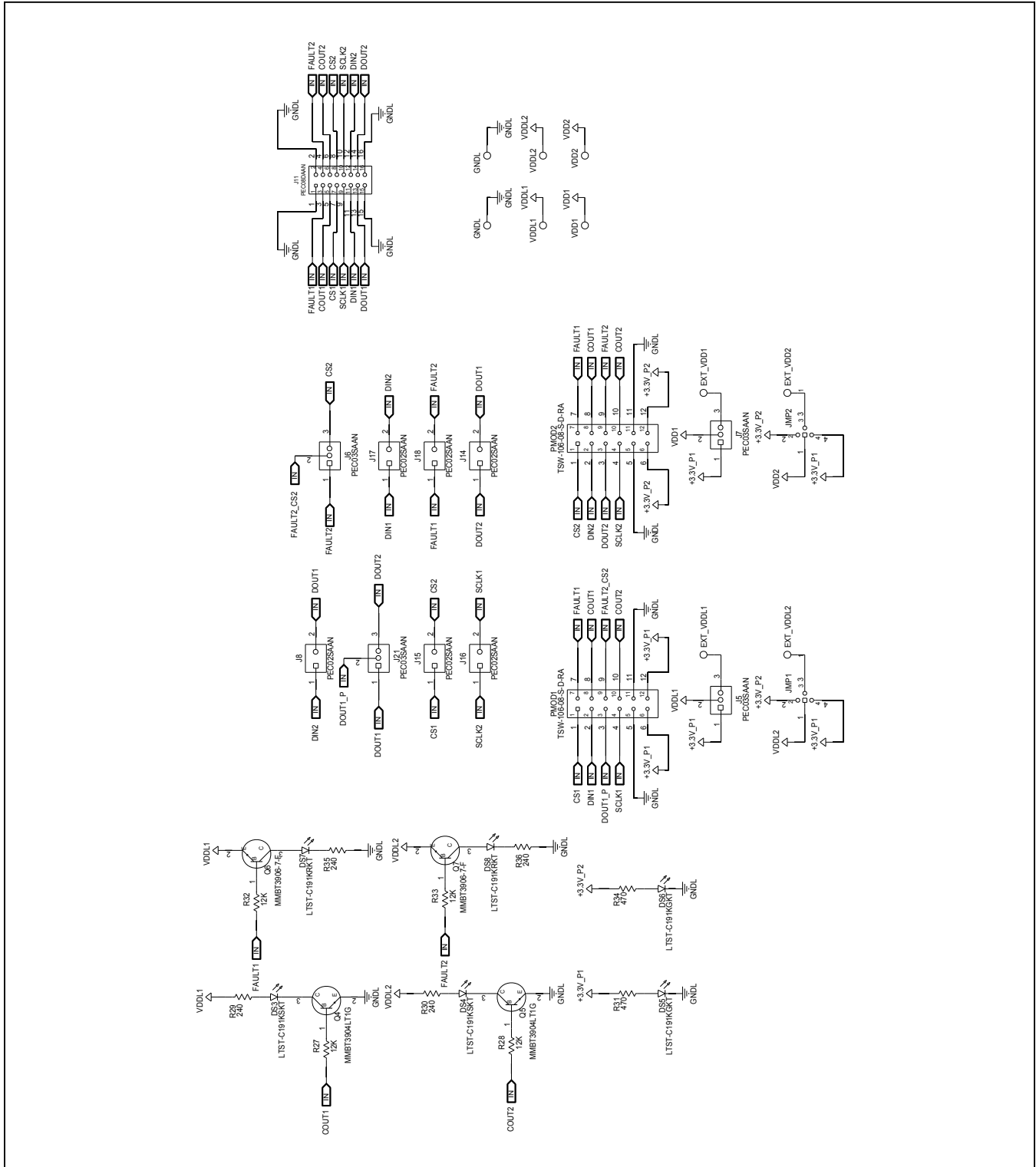

MAX14001/MAX14002 PCB Layout

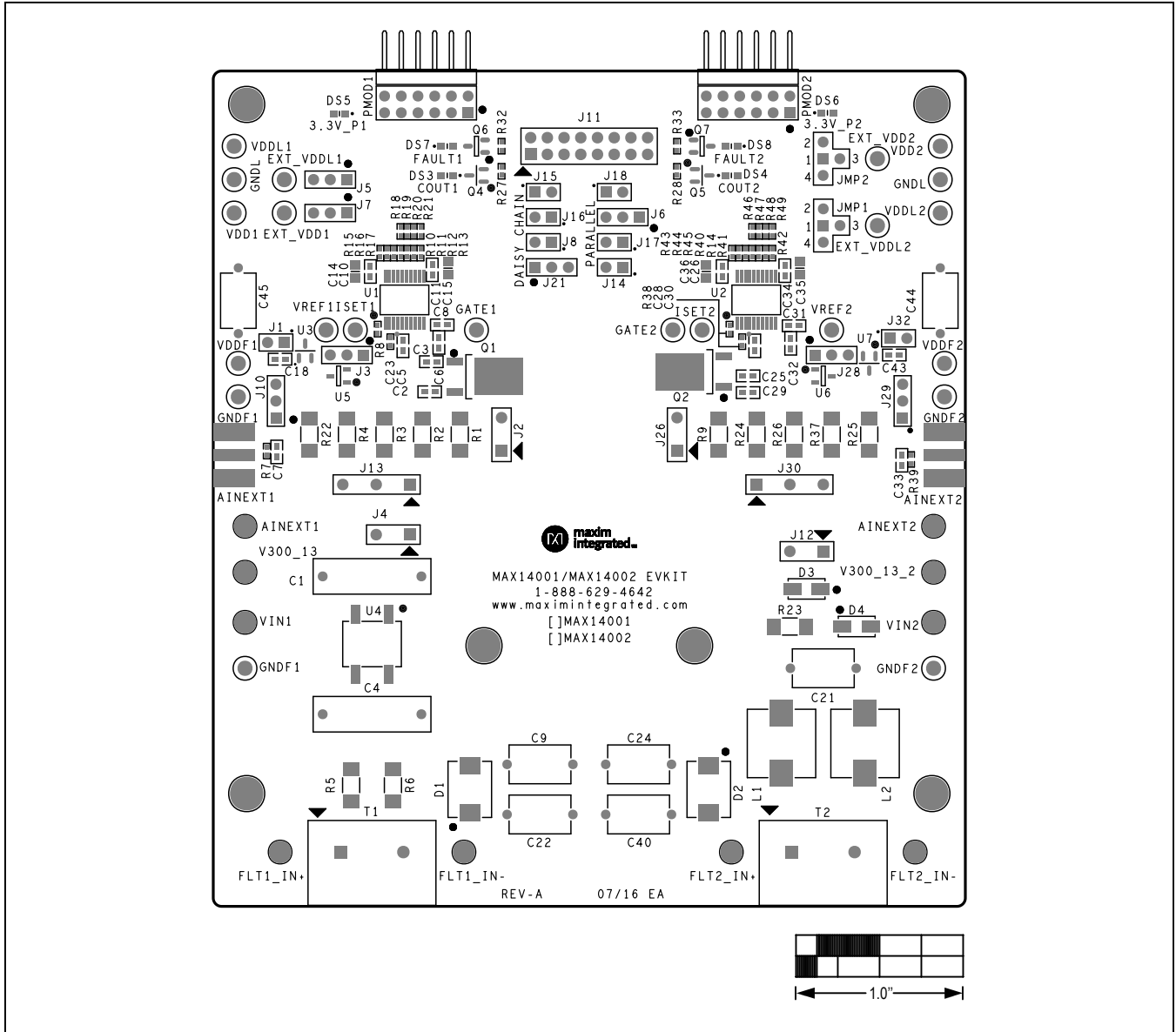

MAX14001/MAX14002 EV Kit—Top Silkscreen

MAX14001/MAX14002 PCB Layout (continued)

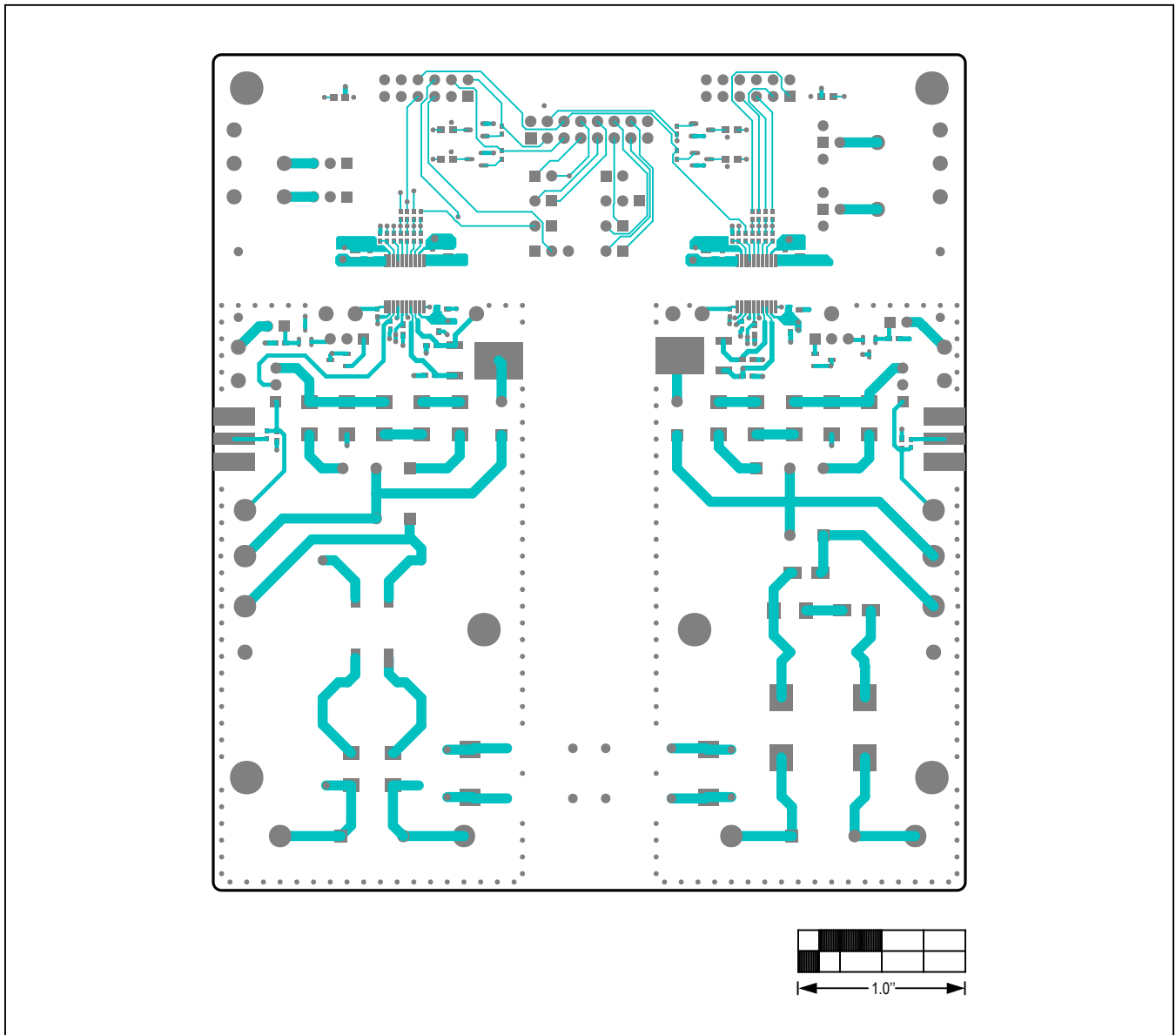

MAX14001/MAX14002 EV Kit—Top

MAX14001/MAX14002 PCB Layout (continued)

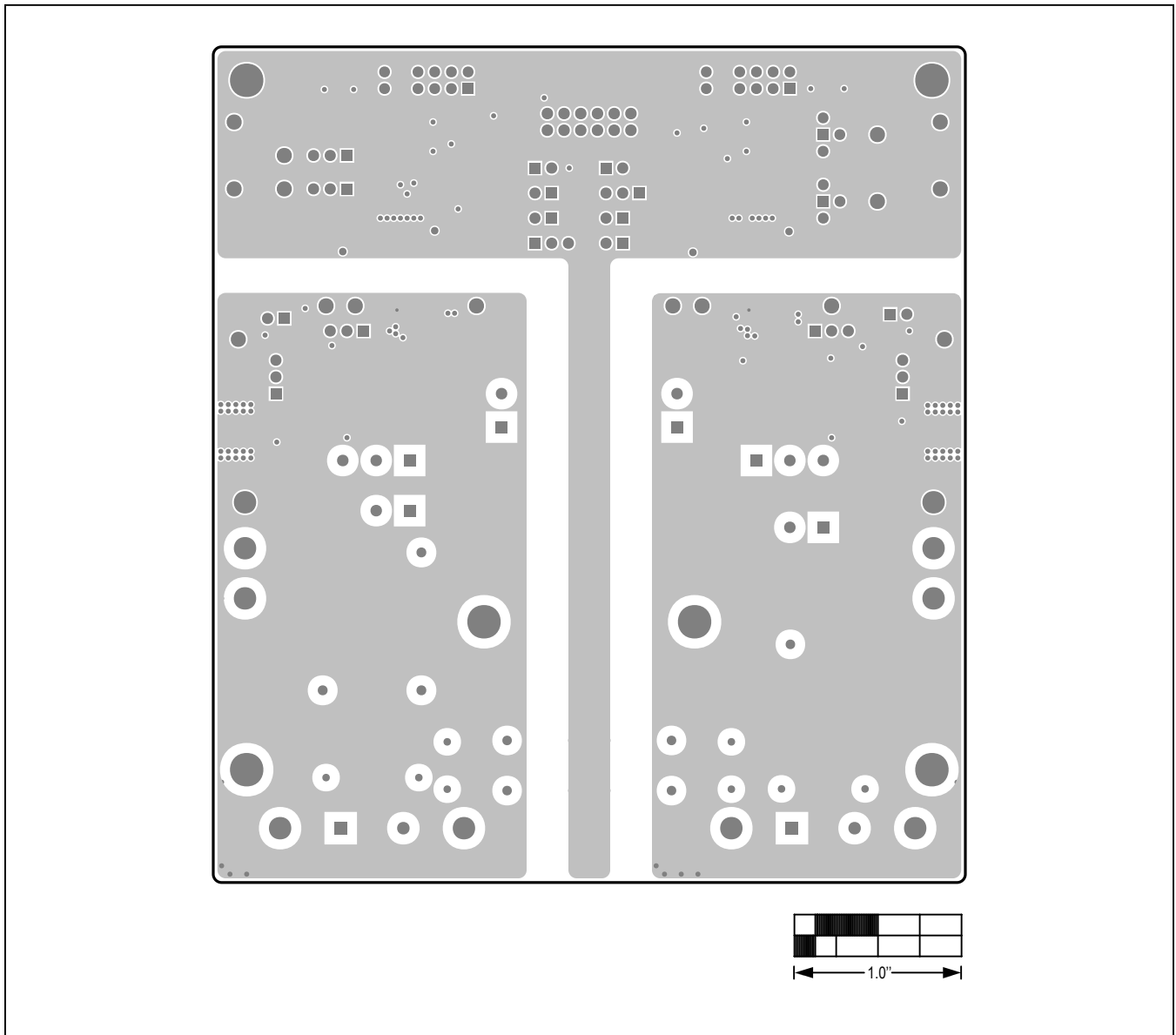

MAX14001/MAX14002 EV Kit—Internal 2

MAX14001/MAX14002 PCB Layout (continued)

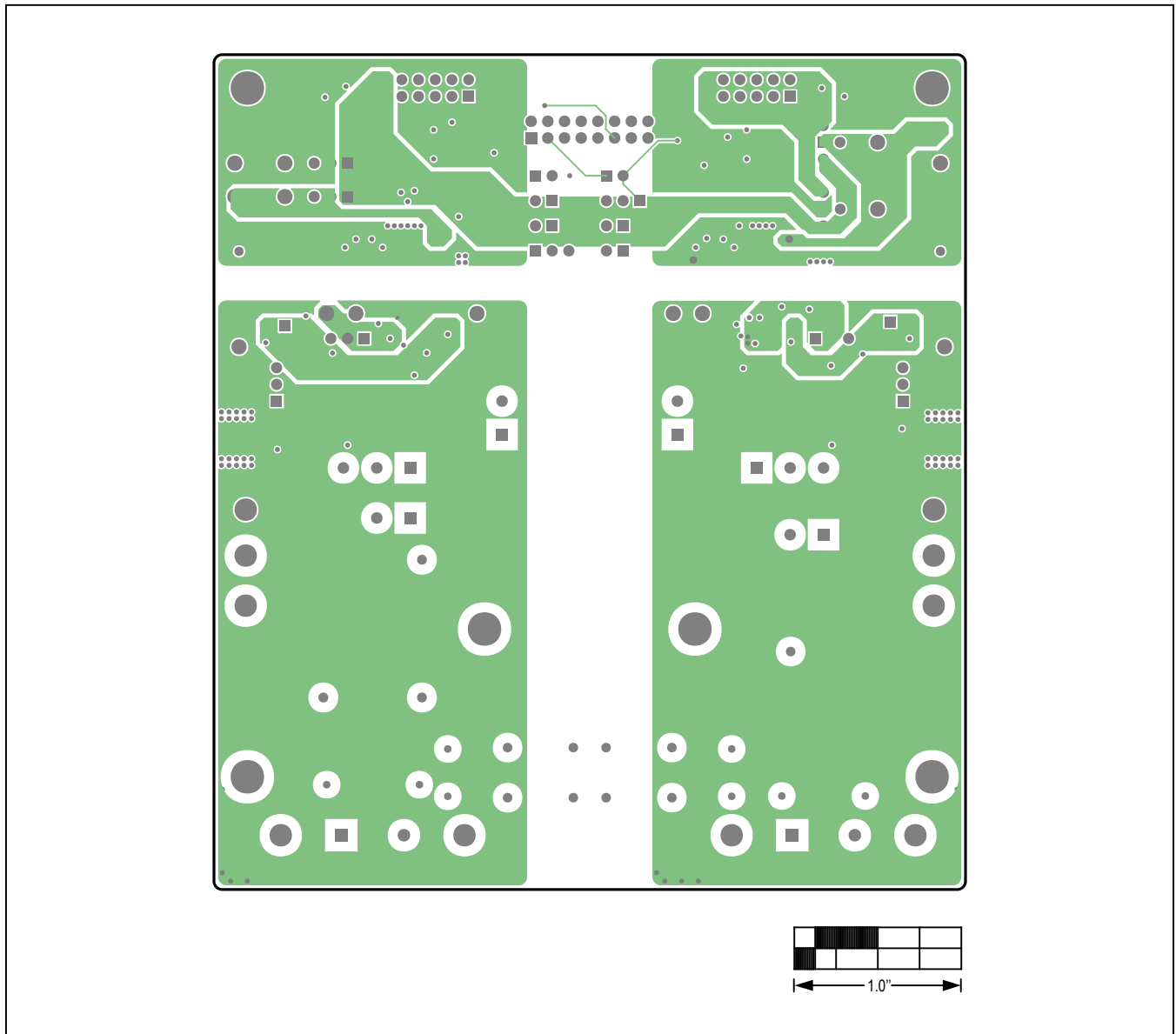

MAX14001/MAX14002 EV Kit—Internal 3



MAX14001/MAX14002 PCB Layout (continued)

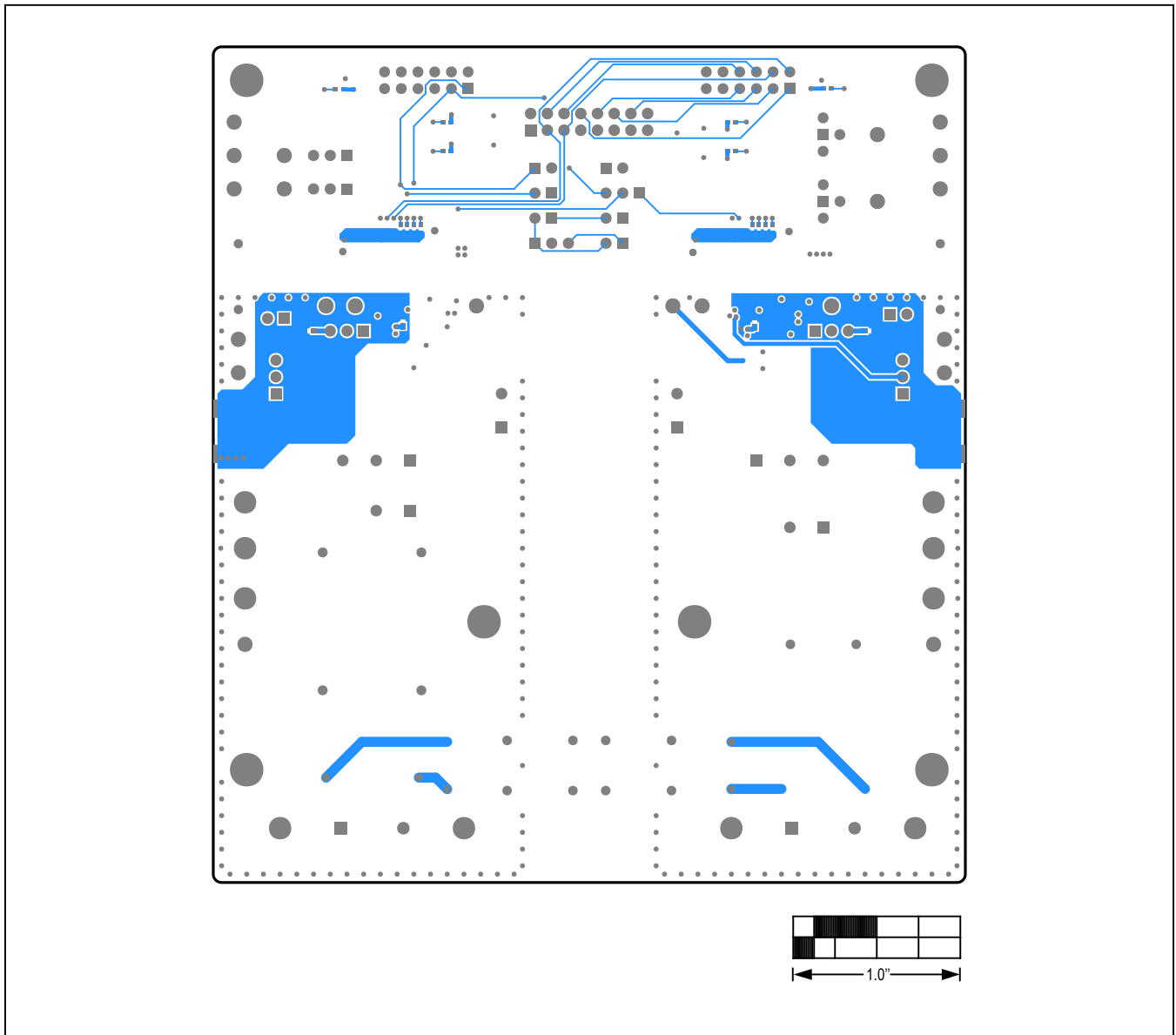

MAX14001/MAX14002 EV Kit—Bottom

MAX14001/MAX14002 PCB Layout (continued)

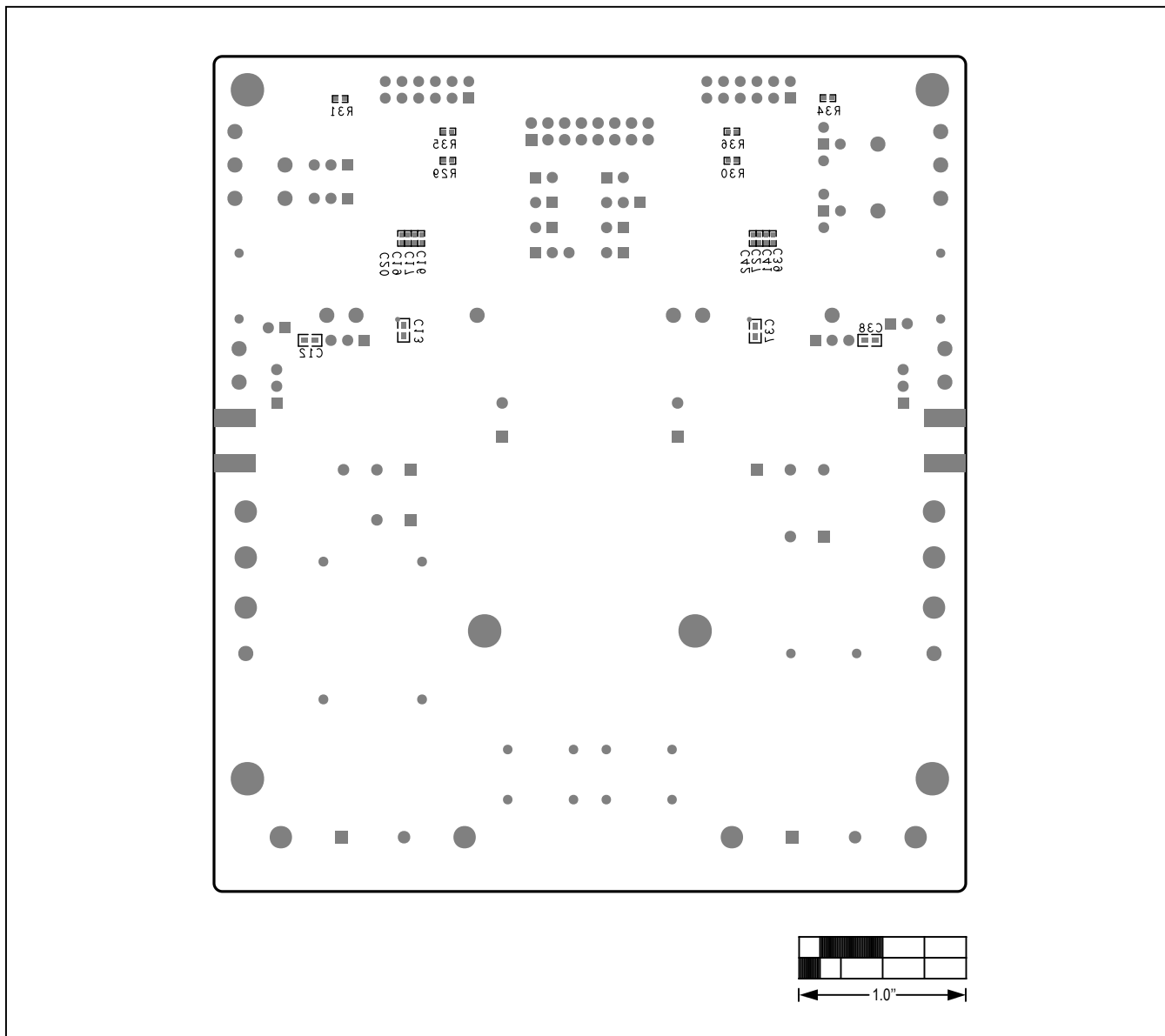

MAX14001/MAX14002 EV Kit—Bottom Silkscreen

## Revision History

REVISION NUMBER	REVISION DATE	DESCRIPTION	PAGES CHANGED
0	11/16	Initial release	—

For pricing, delivery, and ordering information, please contact Maxim Direct at 1-888-629-4642, or visit Maxim Integrated's website at [www.maximintegrated.com](http://www.maximintegrated.com).

*Maxim Integrated cannot assume responsibility for use of any circuitry other than circuitry entirely embodied in a Maxim Integrated product. No circuit patent licenses are implied. Maxim Integrated reserves the right to change the circuitry and specifications without notice at any time.*

Компания «Life Electronics» занимается поставками электронных компонентов импортного и отечественного производства от производителей и со складов крупных дистрибьюторов Европы, Америки и Азии.

С конца 2013 года компания активно расширяет линейку поставок компонентов по направлению коаксиальный кабель, кварцевые генераторы и конденсаторы (керамические, пленочные, электролитические), за счёт заключения дистрибьюторских договоров

Мы предлагаем:

- Конкурентоспособные цены и скидки постоянным клиентам.
- Специальные условия для постоянных клиентов.
- Подбор аналогов.
- Поставку компонентов в любых объемах, удовлетворяющих вашим потребностям.
- Приемлемые сроки поставки, возможна ускоренная поставка.
- Доставку товара в любую точку России и стран СНГ.
- Комплексную поставку.
- Работу по проектам и поставку образцов.
- Формирование склада под заказчика.
- Сертификаты соответствия на поставляемую продукцию (по желанию клиента).
- Тестирование поставляемой продукции.
- Поставку компонентов, требующих военную и космическую приемку.
- Входной контроль качества.
- Наличие сертификата ISO.

В составе нашей компании организован Конструкторский отдел, призванный помогать разработчикам, и инженерам.

Конструкторский отдел помогает осуществить:

- Регистрацию проекта у производителя компонентов.
- Техническую поддержку проекта.
- Защиту от снятия компонента с производства.
- Оценку стоимости проекта по компонентам.
- Изготовление тестовой платы монтаж и пусконаладочные работы.



Тел: +7 (812) 336 43 04 (многоканальный)

Email: [org@lifeelectronics.ru](mailto:org@lifeelectronics.ru)