

COOPER

Bussmann

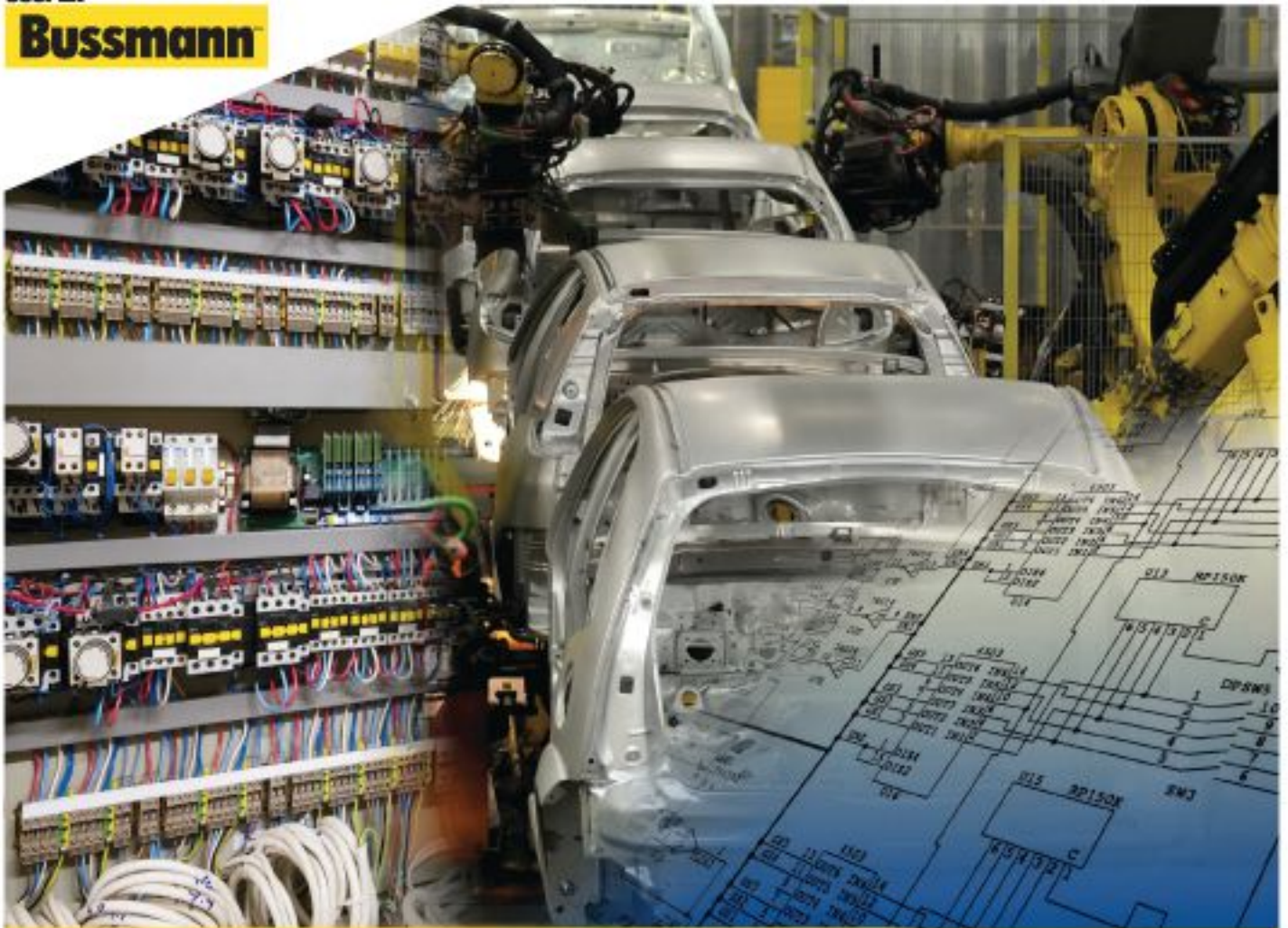

DIN-Rail Terminal Blocks

Simplify Wiring, Power Distribution,
& Circuit Protection

COOPER Bussmann





Terminal Blocks



Accessories



Marking System

See www.CooperBussmann.com/DINTB for detailed specifications, drawings and other information

DIN-Rail Terminal Blocks	4-31
Terminal Block Styles	4-5
Terminal Block Overview	6
Feed Through Blocks (DS Series)	7
Feed Through Blocks (DP Series)	8-9
Mini Feed Through Blocks (DM Series)	10
Double Level Blocks (DDP Series)	11
Disconnect Blocks (DIS Series)	11
Grounding Blocks (DG Series)	12-13
Fuse Holder Blocks (F520 Series)	14-15
Modular Fuse Holder Blocks (CH Series)	16
CH Series Accessories	17-18
Internally Jumpered Blocks (DDNS Series)	19
Test Blocks (DTST2 Series)	19
Panel Mount Blocks	20-21
Feed Through Blocks (NDN Series)	22-23
Feed Through Blocks (C-Rail Series)	24-25
Depluggable Blocks	26-27
Multi-Pole Panel Mount Blocks	28
Quick Connect Blocks	29
Short-Circuit Current Ratings (SCCRs)	30-31
Accessories	32-38
Top Screw-On Bridges	33
End Brackets	34
Partition Plates	34
Jumper Slides	35
Top Insertion Bridges	35
Side Insertion Bridges	36-37
Mounting Rails and Brackets	38
BUSScribe Marking System	39-43
Marking System	40
Marking Labels	41-43
Index	44-45

Terminal Block Styles

The Cooper Bussmann terminal blocks are available in multiple colors for easy circuit identification, plus popular single and double-bridge shaft systems for maximum power distribution flexibility. Certifications include UL1059 (UL File E62622), cURus and IEC 60947-7. Blocks are Short-Circuit Current Rated (SCCR) from 10kA to 200kA. See pages 30-31 for SCCR details.

Feed Through Terminal Blocks

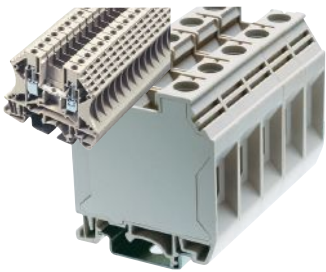

Single-level feed through terminal blocks up to 600V and 150A for wire sizes AWG 22 to 4/0 (0.5mm² to 95.0 mm²).

See page 7

Fuse Holder Terminal Blocks

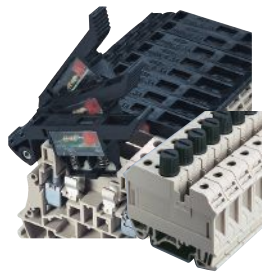

Fuse terminal blocks protect sensors and relays. Available in lever and screw-cap style, with and without LED indication. Uses standard Cooper Bussmann 5 x 20mm fuses.

See page 14

Double Level Terminal Blocks

High-density connectivity using double-level terminal blocks. Marking system, side insertion bridge and top screw-on bridge are standard. Use bridges to achieve any connection topology.



See page 11

Internally Jumpered Terminal Blocks

Internally jumpered double-level terminal blocks provide high-density power distribution in 3-in/1-out or 2-in/2-out or 1-in/3-out options with a single block.

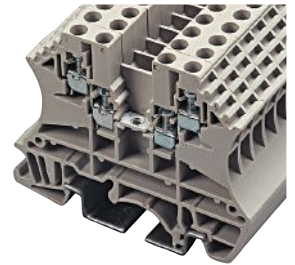

See page 19

Disconnect Terminal Blocks

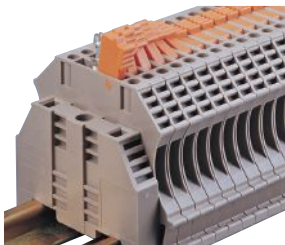

Disconnect terminal blocks offer an easy means of circuit disconnect with just a flick of a screwdriver.

See page 11

Test Terminal Blocks

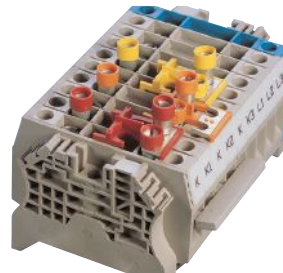

Test terminal blocks with convenient test sockets, plugs, jumpers and accessories to make circuit troubleshooting easy.

See page 19

Grounding Terminal Blocks

Grounding terminal blocks can convert DIN-Rail into a grounding bar. For wire sizes AWG 26 to 4/0 (0.5 mm² to 95.0 mm²).

See page 12



Panel Mount Blocks

Flexible alternative to barrier strips with screw and spring-clamp wiring connections. Single poles assemble together to create custom lengths.

See page 20



NDN Series Feed Through Blocks

Feed through terminal blocks rated up to 90A and 600V. These products are suitable for mounting on either 35mm DIN-Rail or for C-Rail applications.

See page 22



C-Rail Series



C-Rail series terminal blocks are designed specifically for use in C-Rail mounting applications. Products are available with ratings up to 175A and 600V.

See page 24

Depluggable Terminal Blocks

Available for both 35mm DIN-Rail and C-Rail applications.

These products provide a simple depluggable option for panel wiring applications with the convenience of quick, easy, snap-on installation.

See page 26



Multi-Pole Panel Mount Blocks



Panel mount terminal blocks provide a compact, high density circuit connection solution without the necessity of a mounting rail. These products are designed to be nested together to form one string of circuit connections.

See page 28

Quick Connect Terminal Blocks

Quick Connect Terminal Blocks offer a time saving alternative for electrical connections. With male spade terminals, wire connections are made quickly and simply with these terminal blocks. Products are offered for C-Rail and panel mount applications.

See page 29

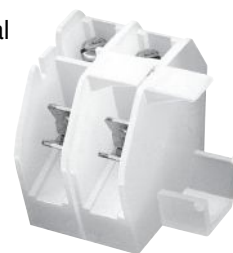

Jumper Bridges

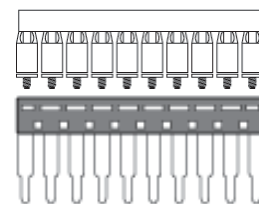

A variety of side insertion bridge, top insertion bridge and top screw-on bridge in multiple pole options are available to solve any power distribution need.

See page 33

Rail Products

An array of rail products are offered to compliment the DIN-Rail Terminal Block product line. Products available include 15mm, G-Type, and 35mm DIN-Rail; C-Rail; and standoff brackets.

See page 38



Marking System and Labels



Open, PC-based software, plotter system can print Cooper Bussmann labels as well as most major competitor labels. A decisive advantage. Blank and pre-printed marking labels are available.

See page 39

Terminal Blocks Overview

Introducing a full range of single-level and two-level feed through screw connection DIN-Rail terminal blocks, test and disconnect blocks, grounding blocks, insertion and screw-on bridges, marking system and accessories. High quality and high functionality for all wiring needs.

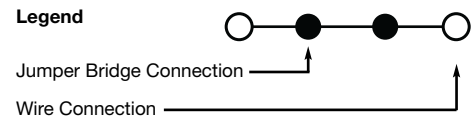
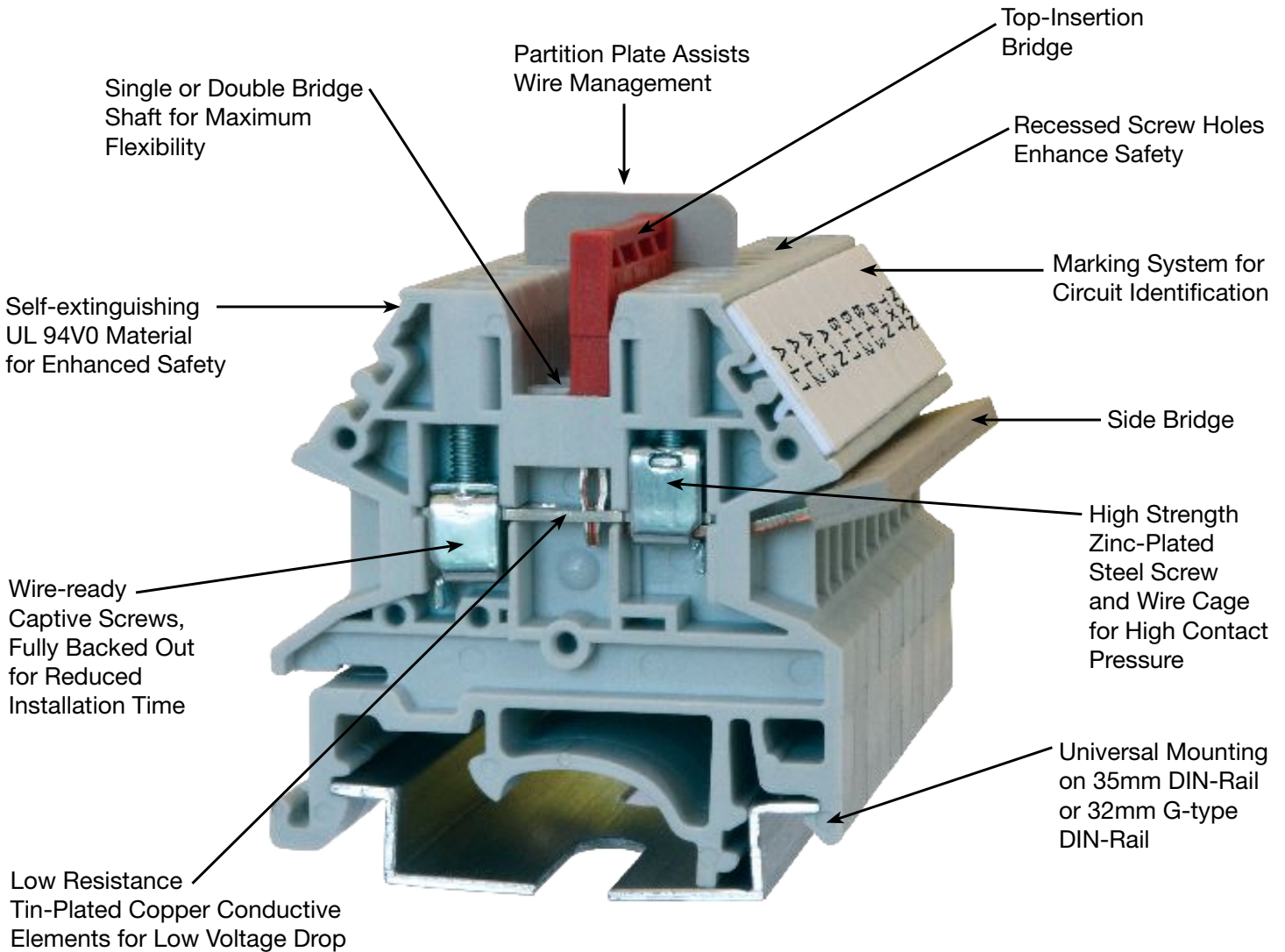

Feed Through Blocks

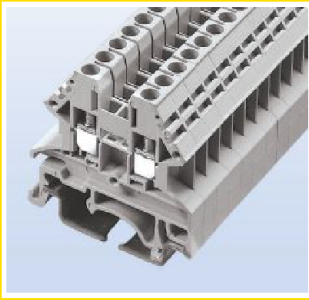

DS Series

The DS Series features a compact design that saves wiring space on the control panel. Accessories include marking labels, partition plates as well as side and top insertion bridges. Designed for 35mm DIN and 32mm G-Type rails.

IEC60947-7-1 & UL 1059 compliant.

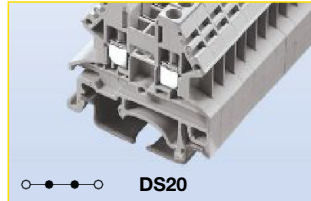

DS20

Approval		
Technical Data	UL	IEC
Rated voltage	600V	1000V
Rated current	20A	24A
Conductor cross section, flexible(AWG/mm ²)	22~12 / 0.5~2.5	
Conductor cross section, flexible(AWG/mm ²)	22~12 / 0.5~2.5	
Rated impulse withstand voltage	6kV	
Torque(N•m)	0.4	
Torque(lb-in)	3.5	
Screw	M2.5	
Wire strip length(mm)	9~11	
WxHxD(mm)	5.1 x 39.6 x 40.5	

Colors	Cat. No.
● Grey	DS20-GY
● Blue	DS20-BU
● Black	DS20-LK
● Red	DS20-RD
● Orange	DS20-OR
● Yellow	DS20-YW
● Green	DS20-GN

Accessories	Cat. No.
● Grey	DS20-GY-ND
● Blue	DS20-BU-ND
● Black	DS20-LK-ND
● Red	DS20-RD-ND
● Orange	DS20-OR-ND
● Yellow	DS20-YW-ND
● Green	DS20-GN-ND

	DKNSPS-001
2-pole	DSS2-5N-02P
3-pole	DSS2-5N-03P
4-pole	DSS2-5N-04P
10-pole	DSS2-5N-10P
2-pole	CSC-2-502PN
3-pole	CSC-2-503PN
4-pole	CSC-2-504PN
10-pole	CSC-2-510PN
2-pole	N/A
3-pole	N/A
4-pole	N/A
10-pole	N/A

Marking label	TM26CB
Mounting Rail	DRL32MMG DRL35MMHI DRL35MMLO
Tool	

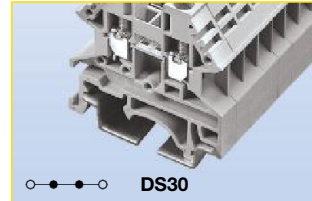

DS30

Approval		
Technical Data	UL	IEC
Rated voltage	600V	1000V
Rated current	30A	32A
Conductor cross section, flexible(AWG/mm ²)	22~10 / 0.5~4	
Conductor cross section, flexible(AWG/mm ²)	22~10 / 0.5~4	
Rated impulse withstand voltage	6kV	
Torque(N•m)	0.6	
Torque(lb-in)	5.3	
Screw	M3	
Wire strip length(mm)	9~11	
WxHxD(mm)	6.1 x 39.6 x 40.3	

Colors	Cat. No.
● Grey	DS30-GY
● Blue	DS30-BU
● Black	DS30-LK
● Red	DS30-RD
● Orange	DS30-OR
● Yellow	DS30-YW
● Green	DS30-GN

Accessories	Cat. No.
● Grey	DS20-GY-ND
● Blue	DS20-BU-ND
● Black	DS20-LK-ND
● Red	DS20-RD-ND
● Orange	DS20-OR-ND
● Yellow	DS20-YW-ND
● Green	DS20-GN-ND

	DKNSPS-001
2-pole	DSS4N-02P
3-pole	DSS4N-03P
4-pole	DSS4N-04P
10-pole	DSS4N-10P
2-pole	CSC-402PN
3-pole	CSC-403PN
4-pole	CSC-404PN
10-pole	CSC-410PN
2-pole	N/A
3-pole	N/A
4-pole	N/A
10-pole	N/A

Marking label	TM27CB
Mounting Rail	DRL32MMG DRL35MMHI DRL35MMLO
Tool	

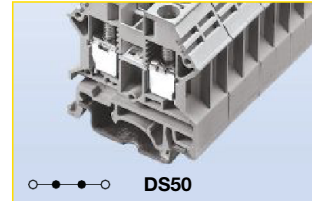

DS50

Approval		
Technical Data	UL	IEC
Rated voltage	600V	1000V
Rated current	50A	41A
Conductor cross section, flexible(AWG/mm ²)	22~10 / 0.5~4	
Conductor cross section, flexible(AWG/mm ²)	20~8 / 0.5~6	
Rated impulse withstand voltage	8kV	
Torque(N•m)	1.2	
Torque(lb-in)	10.6	
Screw	M4	
Wire strip length(mm)	12~14	
WxHxD(mm)	8 x 45 x 41.7	

Colors	Cat. No.
● Grey	DS50-GY
● Blue	DS50-BU
● Black	DS50-LK
● Red	DS50-RD
● Orange	DS50-OR
● Yellow	DS50-YW
● Green	DS50-GN

Accessories	Cat. No.
● Grey	DS50-GY-ND
● Blue	DS50-BU-ND
● Black	DS50-LK-ND
● Red	DS50-RD-ND
● Orange	DS50-OR-ND
● Yellow	DS50-YW-ND
● Green	DS50-GN-ND

	DKNSPS-002
2-pole	DSS6N-02P
3-pole	DSS6N-03P
4-pole	DSS6N-04P
10-pole	DSS6N-10P
2-pole	CSC-602PN
3-pole	CSC-603PN
4-pole	CSC-604PN
10-pole	CSC-610PN
2-pole	N/A
3-pole	N/A
4-pole	N/A
10-pole	N/A

Marking label	TM28CB
Mounting Rail	DRL32MMG DRL35MMHI DRL35MMLO
Tool	

- Block
- End cover
- Small partition
- Top Insertion bridge
- Side Insertion bridge
- Top Screw-on bridge
- Marking label
- Mounting Rail
- Tool

Feed Through Blocks

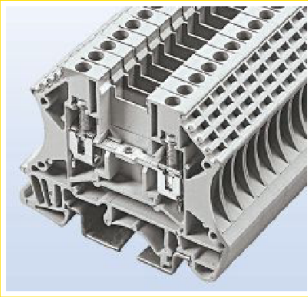

DP Series

The DP Series features a generous design allowing for more wiring space and access. Additionally, this series features a larger wire contact area and larger conducting elements. Accessories include marking labels, partition plates, side insertion bridge and top screw-on bridge for improved reliability. Comes with matching shaped grounding blocks. Designed for 35mm DIN and 32mm G-Type rails.

IEC60947-7 and UL1059 compliant.

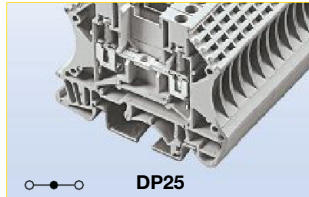
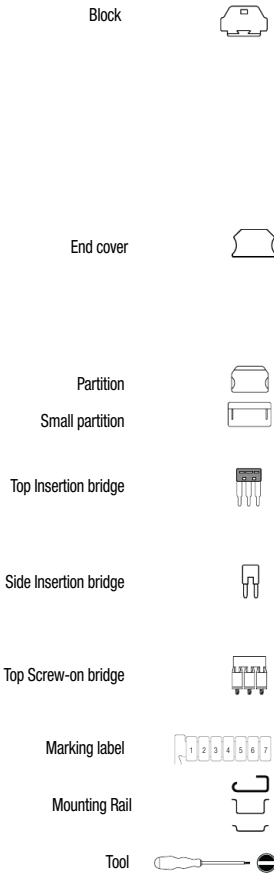

Approval		
Technical Data	UL	IEC
Rated voltage	600V	630V
Rated current	25A	24A
Conductor cross section, flexible(AWG/mm ²)	22~12 / 0.5~2.5	
Conductor cross section, flexible(AWG/mm ²)	22~12 / 0.5~2.5	
Rated impulse withstand voltage	8kV	
Torque(N•m)	0.8	
Torque(lb-in)	7.1	
Screw	M3	
Wire strip length(mm)	10~12	
WxHxD(mm)	5.1 x 47.6 x 58.9	

Colors	Cat. No.
● Grey	DP25-GY
● Blue	DP25-BU
● Black	DP25-LK
● Red	DP25-RD
● Orange	DP25-OR
● Yellow	DP25-YW
● Green	DP25-GN

Accessories	Cat. No.
● Grey	DP25-GY-ND
● Blue	DP25-BU-ND
● Black	DP25-LK-ND
● Red	DP25-RD-ND
● Orange	DP25-OR-ND
● Yellow	DP25-YW-ND
● Green	DP25-GN-ND
	DKSPS-001
	DKSPS-002

2-pole	N/A
3-pole	N/A
4-pole	N/A
10-pole	N/A
2-pole	CSC-2-502P
3-pole	CSC-2-503P
4-pole	CSC-2-504P
10-pole	CSC-2-510P
2-pole	DS2-5-02P
3-pole	DS2-5-03P
4-pole	DS2-5-04P
10-pole	DS2-5-10P
	TM26CB
	DRL32MMG
	DRL35MMHI
	DRL35MMLO
	0.4 x 2.5mm

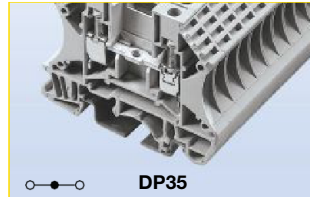

Approval		
Technical Data	UL	IEC
Rated voltage	600V	630V
Rated current	35A	32A
Conductor cross section, flexible(AWG/mm ²)	22~10 / 0.5~4	
Conductor cross section, flexible(AWG/mm ²)	22~10 / 0.5~4	
Rated impulse withstand voltage	8kV	
Torque(N•m)	0.8	
Torque(lb-in)	7.1	
Screw	M3	
Wire strip length(mm)	10~12	
WxHxD(mm)	6.1 x 47.6 x 58.9	

Colors	Cat. No.
● Grey	DP35-GY
● Blue	DP35-BU
● Black	DP35-LK
● Red	DP35-RD
● Orange	DP35-OR
● Yellow	DP35-YW
● Green	DP35-GN

Accessories	Cat. No.
● Grey	DP25-GY-ND
● Blue	DP25-BU-ND
● Black	DP25-LK-ND
● Red	DP25-RD-ND
● Orange	DP25-OR-ND
● Yellow	DP25-YW-ND
● Green	DP25-GN-ND
	DKSPS-001
	DKSPS-002

2-pole	N/A
3-pole	N/A
4-pole	N/A
10-pole	N/A
2-pole	CSC-402P
3-pole	CSC-303P
4-pole	CSC-404P
10-pole	CSC-410P
2-pole	DS4-02P
3-pole	DS4-03P
4-pole	DS4-04P
10-pole	DS4-10P
	TM27CB
	DRL32MMG
	DRL35MMHI
	DRL35MMLO
	0.5 x 3mm

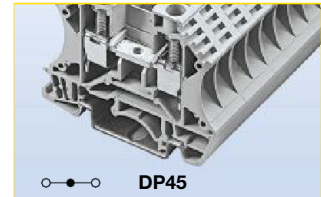

Approval		
Technical Data	UL	IEC
Rated voltage	600V	500V
Rated current	45A	41A
Conductor cross section, flexible(AWG/mm ²)	20~8 / 0.5~6	
Conductor cross section, flexible(AWG/mm ²)	20~8 / 0.5~6	
Rated impulse withstand voltage	8kV	
Torque(N•m)	1.8	
Torque(lb-in)	15.9	
Screw	M4	
Wire strip length(mm)	12~14	
WxHxD(mm)	8 x 47.6 x 58.9	

Colors	Cat. No.
● Grey	DP45-GY
● Blue	DP45-BU
● Black	DP45-LK
● Red	DP45-RD
● Orange	DP45-OR
● Yellow	DP45-YW
● Green	DP45-GN

Accessories	Cat. No.
● Grey	DP25-GY-ND
● Blue	DP25-BU-ND
● Black	DP25-LK-ND
● Red	DP25-RD-ND
● Orange	DP25-OR-ND
● Yellow	DP25-YW-ND
● Green	DP25-GN-ND
	DKSPS-001
	DKSPS-002

2-pole	N/A
3-pole	N/A
4-pole	N/A
10-pole	N/A
2-pole	CSC-602P
3-pole	CSC-603P
4-pole	CSC-604P
10-pole	CSC-610P
2-pole	DS6-02P
3-pole	DS6-03P
4-pole	DS6-04P
10-pole	DS6-10P
	TM28CB
	DRL32MMG
	DRL35MMHI
	DRL35MMLO
	0.8 x 4mm

Feed Through Blocks

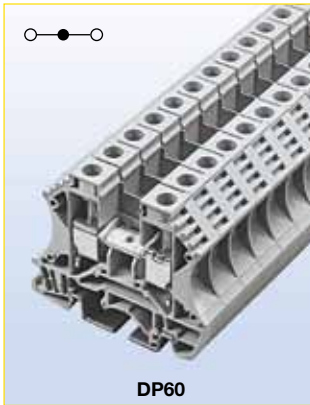

DP60



DP100



DP150



DP230

Approval		
Technical Data	UL	IEC
Rated voltage	600V	500V
Rated current	60A	57A
Conductor cross-section, solid (AWG/mm ²)	20~6 / 1.5~10	
Conductor cross-section, flexible (AWG/mm ²)	20~6 / 1.5~10	
Rated impulse withstand voltage	8kV	
Torque(N•m)	1.8	
Torque(lb-in)	15.9	
Screw	M4	
Wire strip length(mm)	12~14	
WxHxD(mm)	10 x 47.6 x 58.9	

Approval		
Technical Data	UL	IEC
Rated voltage	600V	1000V
Rated current	100A	101A
Conductor cross-section, solid (AWG/mm ²)	14~3 / 1.5~25	
Conductor cross-section, flexible (AWG/mm ²)	14~3 / 1.5~25	
Rated impulse withstand voltage	8kV	
Torque(N•m)	3.4	
Torque(lb-in)	30.1	
Screw	M5	
Wire strip length(mm)	13~15	
WxHxD(mm)	12 x 52.2 x 46.7	

Approval		
Technical Data	UL	IEC
Rated voltage	600V	1000V
Rated current	150A	150A
Conductor cross-section, solid (AWG/mm ²)	12~1/0 / 2.5~50	
Conductor cross-section, flexible (AWG/mm ²)	12~1/0 / 2.5~50	
Rated impulse withstand voltage	8kV	
Torque(N•m)	6.9	
Torque(lb-in)	61.1	
Screw	M6	
Wire strip length(mm)	16~18	
WxHxD(mm)	16 x 61.2 x 52	

Approval		
Technical Data	UL	IEC
Rated voltage	600V	1000V
Rated current	230A	232A
Conductor cross-section, solid (AWG/mm ²)	2 / 35	
Conductor cross-section, flexible (AWG/mm ²)	2~4/0 / 35~95	
Rated impulse withstand voltage	8kV	
Torque(N•m)	10.2	
Torque(lb-in)	90.3	
Screw	M8	
Wire strip length(mm)	30~35	
WxHxD(mm)	25 x 88.5 x 80	

Colors	Cat. No.
● Grey	DP60-GY

Colors	Cat. No.
● Grey	DP100-GY

Colors	Cat. No.
● Grey	DP150-GY
● Blue	DP150-BU

Colors	Cat. No.
● Grey	DP230-GY
● Blue	DP230-BU

Accessories	Cat. No.
● Grey	DP25-GY-ND
	DKSPS-001
	DKSPS-002
2-pole	N/A
3-pole	N/A
4-pole	N/A
10-pole	N/A
2-pole	CSC-1002P
3-pole	CSC-1003P
4-pole	CSC-1004P
10-pole	CSC-1010P
2-pole	DS10-02P
3-pole	DS10-03P
4-pole	DS10-04P
10-pole	DS10-10P
	TM28CB
	DRL32MMG
	DRL35MMHI
	DRL35MMLLO
	0.8 x 4mm

Accessories	Cat. No.
● Grey	DP100-GY-ND
	DKNSPS-003
2-pole	N/A
3-pole	N/A
4-pole	N/A
10-pole	N/A
2-pole	CSC-1602P
3-pole	CSC-1603P
4-pole	CSC-1604P
10-pole	CSC-1610P
2-pole	DS16-02P
3-pole	DS16-03P
4-pole	DS16-04P
10-pole	DS16-10P
	TM28CB
	DRL32MMG
	DRL35MMHI
	DRL35MMLLO
	1.0 x 5.5mm

Accessories	Cat. No.
	DKNSPS-004
2-pole	N/A
3-pole	N/A
4-pole	N/A
10-pole	N/A
2-pole	CSC-3502P
3-pole	CSC-3503P
4-pole	CSC-3504P
10-pole	CSC-3510P
2-pole	DS35-02P
3-pole	DS35-03P
4-pole	DS35-04P
10-pole	DS35-10P
	TM28CB
	DRL32MMG
	DRL35MMHI
	DRL35MMLLO

Accessories	Cat. No.
	DKNSPS-004
2-pole	N/A
3-pole	N/A
4-pole	N/A
10-pole	N/A
2-pole	CSC-9502P
3-pole	CSC-9503P
4-pole	N/A
10-pole	N/A
2-pole	N/A
3-pole	N/A
4-pole	N/A
10-pole	N/A
	TM28CB
	DRL32MMG
	DRL35MMHI
	DRL35MMLLO

Mini Feed Through Blocks



DM Series

The DM Series is our low cost, miniature feed through terminal block design for 15mm DIN-Rail. Accessories include side insertion bridge and marking labels.



DM20



DM30



DM50

Approval c us

Technical Data	UL	IEC
Rated voltage	300V	500V
Rated current	20A	24A
Conductor cross-section, solid (AWG/mm ²)	22-12 / 0.5-2.5	
Conductor cross-section, flexible (AWG/mm ²)	22-12 / 0.5-2.5	
Rated impulse withstand voltage	5kV	
Torque(N•m)	0.4	
Torque(lb-in)	3.5	
Screw	M2.5	
Wire strip length(mm)	7-9	
WxHxD(mm)	5.1 x 28 x 22	

Colors Cat. No.

	DM20-GY
	DM20-BU
	DM20-LK

Accessories Cat. No.

	DM20-GY-ND
	DM20-BU-ND
	DM20-LK-ND

2-pole	N/A
3-pole	N/A
4-pole	N/A
10-pole	N/A
2-pole	CSC-2-502PS
3-pole	CSC-2-503PS
4-pole	CSC-2-504PS
10-pole	CSC-2-510PS
2-pole	N/A
3-pole	N/A
4-pole	N/A
10-pole	N/A

Marking label TM20CB

Mounting Rail DRL15MM

Tool

Approval c us

Technical Data	UL	IEC
Rated voltage	300V	500V
Rated current	30A	32A
Conductor cross-section, solid (AWG/mm ²)	22-10 / 0.5-4	
Conductor cross-section, flexible (AWG/mm ²)	22-10 / 0.5-4	
Rated impulse withstand voltage	5kV	
Torque(N•m)	0.6	
Torque(lb-in)	5.3	
Screw	M3	
Wire strip length(mm)	7-9	
WxHxD(mm)	6.1 x 31.5 x 22	

Colors Cat. No.

	DM30-GY
	DM30-BU
	DM30-LK

Accessories Cat. No.

	DM30-GY-ND
	DM30-BU-ND
	DM30-LK-ND

2-pole	N/A
3-pole	N/A
4-pole	N/A
10-pole	N/A
2-pole	CSC-402PS
3-pole	CSC-303PS
4-pole	CSC-404PS
10-pole	CSC-410PS
2-pole	N/A
3-pole	N/A
4-pole	N/A
10-pole	N/A

Marking label TM21CB

Mounting Rail DRL15MM

Tool

Approval c us

Technical Data	UL	IEC
Rated voltage	300V	500V
Rated current	50A	41A
Conductor cross-section, solid (AWG/mm ²)	20-8 / 0.5-6	
Conductor cross-section, flexible (AWG/mm ²)	20-8 / 0.5-6	
Rated impulse withstand voltage	6kV	
Torque(N•m)	1.2	
Torque(lb-in)	10.6	
Screw	M4	
Wire strip length(mm)	9-11	
WxHxD(mm)	8 x 37.4 x 30	

Colors Cat. No.

	DM50-GY
	DM50-BU
	DM50-LK

Accessories Cat. No.

	DM50-GY-ND
	DM50-BU-ND
	DM50-LK-ND

2-pole	N/A
3-pole	N/A
4-pole	N/A
10-pole	N/A
2-pole	CSC-602PS
3-pole	CSC-603PS
4-pole	CSC-604PS
10-pole	CSC-610PS
2-pole	N/A
3-pole	N/A
4-pole	N/A
10-pole	N/A

Marking label TM22CB

Mounting Rail DRL15MM

Tool

Series A2000 & LP2000
Single Row Terminal Blocks

Part Numbering System

Series	Terminal Style	Base/End	Poles	Screw Options	Options
A2					
LP2					
A2 - standard barrier LP2 - low profile barrier	01* - handwired 02 - printed circuit 03 - non feed-thru 04 - wire wrap tail 06 - handwired 07 - extended pin 08 - printed circuit 09 - 0.250" QC short 10 - 0.187" QC 14 - printed circuit 19 - 0.250" QC long	1 - std. base/mnt. end 2 - std. base/barrier end 3 - insulator base/mnt. end 4 - insulator base/barrier end 5 - closed base/mount end 6 - closed base/molded mount end	02 to 32 02 to 30 on mount end base	Blank - std. screw 00 - screws shipped bulk 03* - stainless steel 04 - brass nickel-plated 07 - steel SEMS (not available with hardware options) 09* - brass SEMS nickel-plated (not available with hardware options) CA** - captive screw WR - wire ready (not available on LP2 series)	AB* - angle mnt. options (pg 13) A1 to A9 - 0.250" QC B1 to B9 - 0.187" QC DR* - drilled right angle (pg 13) L1 to L6 marking options (pg 27) MP* mounting plates (pg 13) RC* - retaining clips (pg 13) R30 to R77 - right angle bends (pg 13) S1* - solder lug/flat JA***, JB*** & JC*** - barrier jumpers OJ2*** & OJ4*** - over barrier jumpers (not available w/covers) Covers - (pg 28)
		Base/End Note: 6 style not available with covers. 5 & 6 Styles only available with 03 terminals.			

*A2 only.
**Not compatible with 03-stainless steel screws.
***Contact factory for configuration.

Terminal Styles

Inches (Millimeters)

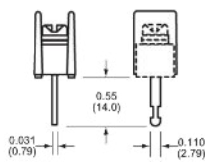

01
Handwired

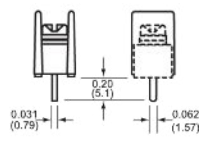

02
Printed Circuit



03
Non Feed-Thru

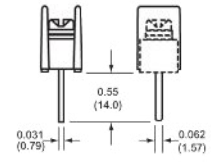

04
Wire Wrap Tail

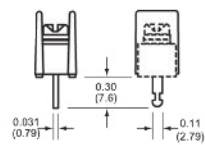

06
Handwired

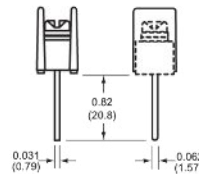

07
Extended Pin

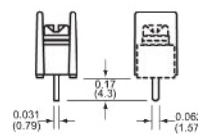

08
Printed Circuit

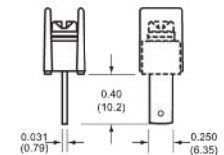

09
0.250" QC short

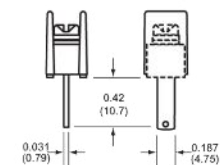

10
0.187" QC

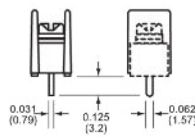

14
Printed Circuit

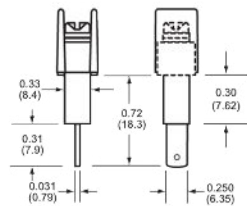

19
0.250" QC long

Grounding Blocks

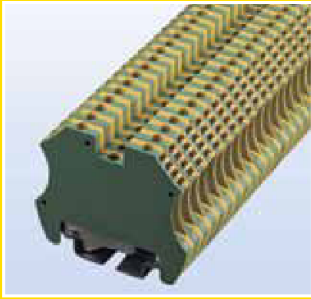

DG Series

The DG Series grounding DIN-Rail Terminal blocks fit both standard 35mm DIN-Rail and 32mm G-Type rails. Compliant with IEC60947-7 and UL1059 standards for worldwide acceptance. These have the same general shape as the DP Series.

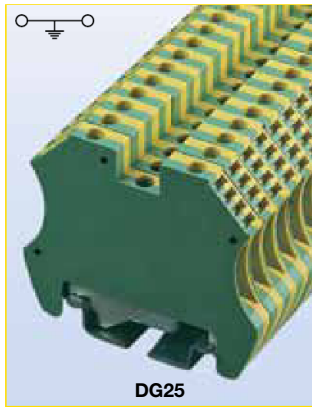

DG25



DG35

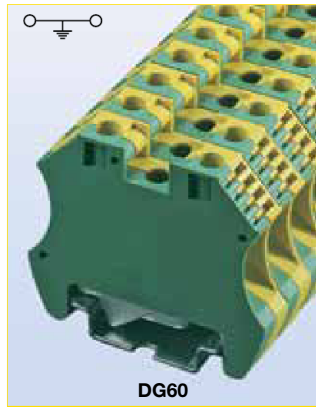

DG60

Approval **US**

Technical Data	UL	IEC
Rated voltage	600V	630V
Rated current	24A	
Conductor cross-section, solid (AWG/mm ²)	26~12 / 0.5~2.5	
Conductor cross-section, flexible (AWG/mm ²)	26~12 / 0.5~2.5	
Rated impulse withstand voltage	8kV	
Torque(N•m)	0.8	
Torque(lb-in)	7.1	
Screw	M3	
Wire strip length(mm)	10~14	
WxHxD(mm)	5.7 x 46.4 x 56	

Approval **US**

Technical Data	UL	IEC
Rated voltage	600V	630V
Rated current	32A	
Conductor cross-section, solid (AWG/mm ²)	26~10 / 0.5~4	
Conductor cross-section, flexible (AWG/mm ²)	26~10 / 0.5~4	
Rated impulse withstand voltage	8kV	
Torque(N•m)	0.8	
Torque(lb-in)	7.1	
Screw	M3	
Wire strip length(mm)	12~16	
WxHxD(mm)	6.6 x 46.4 x 56	

Approval **US**

Technical Data	UL	IEC
Rated voltage	600V	500V
Rated current	57A	
Conductor cross-section, solid (AWG/mm ²)	16~8 / 1.5~10	
Conductor cross-section, flexible (AWG/mm ²)	16~8 / 1.5~10	
Rated impulse withstand voltage	8kV	
Torque(N•m)	1.8	
Torque(lb-in)	15.9	
Screw	M4	
Wire strip length(mm)	12~16	
WxHxD(mm)	10.4 x 46.4 x 56	

Colors **Cat. No.**

Yellow-Green DG25-YG

Colors **Cat. No.**

Yellow-Green DG35-YG

Colors **Cat. No.**

Yellow-Green DG60-YG

Block



Accessories **Cat. No.**

Accessories **Cat. No.**

Accessories **Cat. No.**

End cover

Partition

Small partition

Top Insertion bridge



Side Insertion bridge



Top Screw-on bridge



Marking label



Mounting Rail



Tool



2-pole	N/A
3-pole	N/A
4-pole	N/A
10-pole	N/A

2-pole	N/A
3-pole	N/A
4-pole	N/A
10-pole	N/A

2-pole	N/A
3-pole	N/A
4-pole	N/A
10-pole	N/A

2-pole	N/A
3-pole	N/A
4-pole	N/A
10-pole	N/A

2-pole	N/A
3-pole	N/A
4-pole	N/A
10-pole	N/A

2-pole	N/A
3-pole	N/A
4-pole	N/A
10-pole	N/A

2-pole	N/A
3-pole	N/A
4-pole	N/A
10-pole	N/A

2-pole	N/A
3-pole	N/A
4-pole	N/A
10-pole	N/A

2-pole	N/A
3-pole	N/A
4-pole	N/A
10-pole	N/A

TM26CB

TM27CB

TM28CB

DRL32MMG
DRL35MMHI
DRL35MMLO

DRL32MMG
DRL35MMHI
DRL35MMLO

DRL32MMG
DRL35MMHI
DRL35MMLO

0.5 x 3mm

0.5 x 3mm

0.8 x 4mm

Grounding Blocks

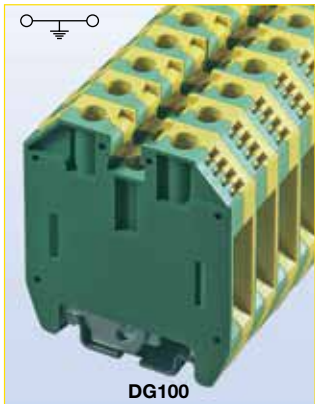

DG100



DG150

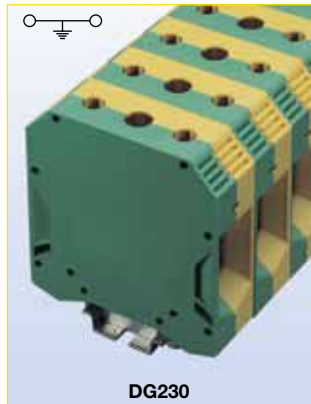

DG230

Approval

Technical Data	UL	IEC
Rated voltage	600V	1000V
Rated current		76A
Conductor cross-section, solid (AWG/mm ²)	14~6 / 2.5~16	
Conductor cross-section, flexible (AWG/mm ²)	14~6 / 2.5~16	
Rated impulse withstand voltage	8kV	
Torque(N•m)	3.4	
Torque(lb-in)	30.1	
Screw	M5	
Wire strip length(mm)	14~18	
WxHxD(mm)	12 x 62.4 x 56	

Colors **Cat. No.**

Yellow-Green DG100-YG

Approval

Technical Data	UL	IEC
Rated voltage	600V	1000V
Rated current		125A
Conductor cross-section, solid (AWG/mm ²)	12~2 / 4~35	
Conductor cross-section, flexible (AWG/mm ²)	12~2 / 4~35	
Rated impulse withstand voltage	8kV	
Torque(N•m)	5.6	
Torque(lb-in)	49.6	
Screw	M6	
Wire strip length(mm)	14~18	
WxHxD(mm)	16 x 62.4 x 56	

Colors **Cat. No.**

Yellow-Green DG150-YG

Approval

Technical Data	UL	IEC
Rated voltage	600V	1000V
Rated current		232A
Conductor cross-section, solid (AWG/mm ²)	2 / 35	
Conductor cross-section, flexible (AWG/mm ²)	2~4/0 / 35~95	
Rated impulse withstand voltage	8kV	
Torque(N•m)	18	
Torque(lb-in)	159.3	
Screw	M8	
Wire strip length(mm)	20~25	
WxHxD(mm)	25 x 82.93 x 80	

Colors **Cat. No.**

Yellow-Green DG230-YG

Accessories **Cat. No.**

2-pole	N/A
3-pole	N/A
4-pole	N/A
10-pole	N/A

2-pole	N/A
3-pole	N/A
4-pole	N/A
10-pole	N/A

2-pole	N/A
3-pole	N/A
4-pole	N/A
10-pole	N/A

TM28CB

DRL32MMG
DRL35MMHI
DRL35MMLLO

1.0 x 5.5mm

Accessories **Cat. No.**

2-pole	N/A
3-pole	N/A
4-pole	N/A
10-pole	N/A

2-pole	N/A
3-pole	N/A
4-pole	N/A
10-pole	N/A

2-pole	N/A
3-pole	N/A
4-pole	N/A
10-pole	N/A

TM28CB

DRL32MMG
DRL35MMHI
DRL35MMLLO

1.0 x 5.5mm

Accessories **Cat. No.**

2-pole	N/A
3-pole	N/A
4-pole	N/A
10-pole	N/A

2-pole	N/A
3-pole	N/A
4-pole	N/A
10-pole	N/A

2-pole	N/A
3-pole	N/A
4-pole	N/A
10-pole	N/A

TM28CB

DRL32MMG
DRL35MMHI
DRL35MMLLO



Fuse Holder Blocks



F520 Series

Fuse terminal blocks protect your sensors and relays. Available in lever and screw-cap style, with and without LED indication. Uses standard Cooper Bussmann 5 x 20 mm fuses.

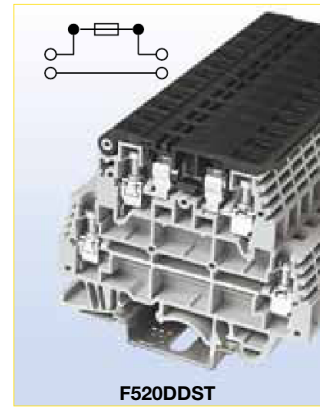
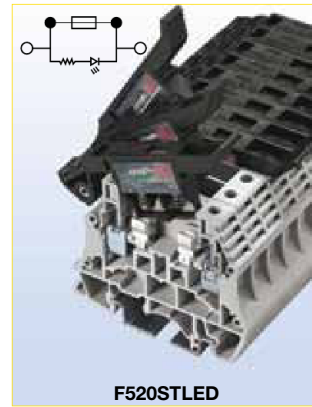
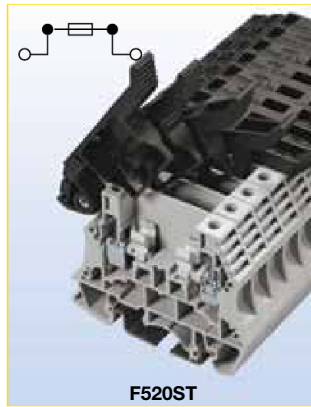

Approval		
Technical Data		
Rated voltage	300V	300V
Rated current	6.3A	6.3A
Conductor cross-section, solid (AWG/mm ²)	24~12 / 0.5~4	
Conductor cross-section, flexible (AWG/mm ²)	24~12 / 0.5~4	
Rated impulse withstand voltage	6kV	
Torque(N•m)	0.8	
Torque(lb-in)	7.1	
Screw	M3	
Wire strip length(mm)	10~12	
WxHxD(mm)	8 x 55.7 x 56	

Approval		
Technical Data		
Rated voltage	300V	300V
Rated current	6.3A	6.3A
Conductor cross-section, solid (AWG/mm ²)	24~12 / 0.5~4	
Conductor cross-section, flexible (AWG/mm ²)	24~12 / 0.5~4	
Rated impulse withstand voltage	6kV	
Torque(N•m)	0.8	
Torque(lb-in)	7.1	
Screw	M3	
Wire strip length(mm)	10~12	
WxHxD(mm)	8 x 55.7 x 56	

Approval		
Technical Data		
Rated voltage	300V ¹⁾	300V
Rated current	16A ²⁾	16A ²⁾
	30A ³⁾	30A ³⁾
Conductor cross-section, solid (AWG/mm ²)	22~10 / 0.5~4	
Conductor cross-section, flexible (AWG/mm ²)	22~10 / 0.5~4	
Rated impulse withstand voltage	6kV	
Torque(N•m)	0.67	
Torque(lb-in)	5.9	
Screw	M3.5	
Wire strip length(mm)	10~12	
WxHxD(mm)	8 x 60.5 x 72.5	

Colors	Cat. No.
● Grey	F520ST-GY

Accessories	Cat. No.
● Grey	F520-GY-ND

2-pole	N/A
3-pole	N/A
4-pole	N/A
10-pole	N/A

2-pole	CSC-602PN
3-pole	CSC-603PN
4-pole	CSC-604PN
10-pole	CSC-610PN

2-pole	N/A
3-pole	N/A
4-pole	N/A
10-pole	N/A

	TM28CB

	DRL32MMG
	DRL35MMHI
	DRL35MMLO

	0.5 x 3mm

Colors	Voltage	Cat. No.
● Grey	5V	F520STLED5-GY
● Grey	12V	F520STLED12-GY
● Grey	24V	F520STLED24-GY
● Grey	48V	F520STLED48-GY
● Grey	110V	F520STLED110-GY
● Grey	220V	F520STLED220-GY
● Grey	300V	F520STLED300-GY

Accessories	Cat. No.
● Grey End Cover	F520-GY-ND

2-pole	CSC-602PN
3-pole	CSC-603PN
4-pole	CSC-604PN
10-pole	CSC-610PN

2-pole	N/A
3-pole	N/A
4-pole	N/A
10-pole	N/A

	TM28CB

	DRL32MMG
	DRL35MMHI
	DRL35MMLO

	0.5 x 3mm

Colors	Cat. No.
● Grey	F520DDST-GY

1) UL 600V / 5A	
2) upper level 3) lower level	

Accessories	Cat. No.
● Grey	F520DD-GY-ND

2-pole	N/A
3-pole	N/A
4-pole	N/A
10-pole	N/A

2-pole	N/A
3-pole	N/A
4-pole	N/A
10-pole	N/A

	TM28CB

	DRL32MMG
	DRL35MMHI
	DRL35MMLO

	0.5 x 3mm

Block



End cover



Partition

Small partition

Top Insertion bridge



Side Insertion bridge



Top Screw-on bridge



Marking label



Mounting Rail



Tool

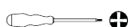

Fuse Holder Blocks

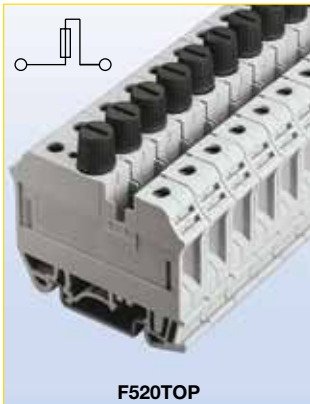

F520TOP

Approval **us**

Technical Data	UL	IEC
Rated voltage	600V	660V
Rated current	6.3A	6.3A
Conductor cross-section, solid (AWG/mm ²)	22~6 / 1.5~10	
Conductor cross-section, flexible (AWG/mm ²)	22~6 / 1.5~10	
Rated impulse withstand voltage	6kV	
Torque(N•m)	1.8	
Torque(lb-in)	15.9	
Screw	M4	
Wire strip length(mm)	12~16	
WxHxD(mm)	12 x 47.2 x 61.6	

Colors **Cat. No.**

● Grey	F520TOP-GY
--------	------------

Accessories **Cat. No.**

2-pole	N/A
3-pole	N/A
4-pole	N/A
10-pole	N/A
2-pole	N/A
3-pole	N/A
4-pole	N/A
10-pole	N/A
2-pole	N/A
3-pole	N/A
4-pole	N/A
10-pole	N/A
	TM20CB
	DRL32MMG DRL35MMHI DRL35MMLLO
	0.6 x 3.5mm



Modular Fuse Holder Blocks





CH Series

With a wide wire range and industry leading ratings - up to 32A, 1000V, 200kA SCCR - the new CH Series provides worldwide acceptance and easy specification - including the latest PV fuse holder standard (UL4248-18) and IEC 60269-1,-2. Use with midget, 10x38, PV or Class CC fuses. Also certified to CCC Standard (China Compulsory Certificate).



See brochure 3185 for detailed specifications.



Approval   		
Technical Data	UL	IEC
Rated voltage	600V	690V
Rated current	30A	32A
Conductor cross-section, solid (AWG/mm ²)	18~10 / 0.8~5.2	
Conductor cross-section, flexible (AWG/mm ²)	18~4 / 0.8~21.1	
Torque(N•m)	3.4	
Torque(lb-in)	30.0 (max)	
SCCR(kA)	200	
WxHxD(mm)	17.5 x 73.9 x 61.8	



Colors	Cat. No.
● Grey	CHM1DIU





Approval   		
Technical Data	UL	IEC
Rated voltage	1000Vdc	1000Vdc
Rated current	30A	32A
Conductor cross-section, solid (AWG/mm ²)	18~10 / 0.8~5.2	
Conductor cross-section, flexible (AWG/mm ²)	18~4 / 0.8~21.1	
Torque(N•m)	3.4	
Torque(lb-in)	30.0 (max)	
SCCR(kA)	33	
WxHxD(mm)	17.5 x 73.9 x 61.8	

Colors	Cat. No.
● Grey	CHPV1IU



Approval   	
Technical Data	UL
Rated voltage	600V
Rated current	30A
Conductor cross-section, solid (AWG/mm ²)	18~10 / 0.8~5.2
Conductor cross-section, flexible (AWG/mm ²)	18~4 / 0.8~21.1
Torque(N•m)	3.4
Torque(lb-in)	30.0 (max)
SCCR(kA)	200
WxHxD(mm)	17.5 x 73.9 x 61.8

Colors	Cat. No.
● Grey	CHCC1DIU

Fuse	Midget	PV	Class CC																																				
	10 x 38	10 x 38																																					
Multi-pole with Indicator	<table border="1"> <tr><td>□</td><td>1 pole</td><td>CHM1DIU</td></tr> <tr><td>□□</td><td>2-pole</td><td>CHM2DIU</td></tr> <tr><td>□□□</td><td>3-pole</td><td>CHM3DIU</td></tr> <tr><td>□□□□</td><td>4-pole</td><td>CHM4DIU</td></tr> </table>	□	1 pole	CHM1DIU	□□	2-pole	CHM2DIU	□□□	3-pole	CHM3DIU	□□□□	4-pole	CHM4DIU	<table border="1"> <tr><td>□</td><td>1 pole</td><td>CHPV1IU</td></tr> <tr><td>□□</td><td>2-pole</td><td>CHPV2IU</td></tr> <tr><td>□□□</td><td>3-pole</td><td>N/A</td></tr> <tr><td>□□□□</td><td>4-pole</td><td>N/A</td></tr> </table>	□	1 pole	CHPV1IU	□□	2-pole	CHPV2IU	□□□	3-pole	N/A	□□□□	4-pole	N/A	<table border="1"> <tr><td>□</td><td>1 pole</td><td>CHCC1DIU</td></tr> <tr><td>□□</td><td>2-pole</td><td>CHCC2DIU</td></tr> <tr><td>□□□</td><td>3-pole</td><td>CHCC3DIU</td></tr> <tr><td>□□□□</td><td>4-pole</td><td>N/A</td></tr> </table>	□	1 pole	CHCC1DIU	□□	2-pole	CHCC2DIU	□□□	3-pole	CHCC3DIU	□□□□	4-pole	N/A
□	1 pole	CHM1DIU																																					
□□	2-pole	CHM2DIU																																					
□□□	3-pole	CHM3DIU																																					
□□□□	4-pole	CHM4DIU																																					
□	1 pole	CHPV1IU																																					
□□	2-pole	CHPV2IU																																					
□□□	3-pole	N/A																																					
□□□□	4-pole	N/A																																					
□	1 pole	CHCC1DIU																																					
□□	2-pole	CHCC2DIU																																					
□□□	3-pole	CHCC3DIU																																					
□□□□	4-pole	N/A																																					
Multi-pole without Indicator	<table border="1"> <tr><td>□</td><td>1 pole</td><td>CHM1DU</td></tr> <tr><td>□□</td><td>2-pole</td><td>CHM2DU</td></tr> <tr><td>□□□</td><td>3-pole</td><td>CHM3DU</td></tr> <tr><td>□□□□</td><td>4-pole</td><td>CHM4DU</td></tr> </table>	□	1 pole	CHM1DU	□□	2-pole	CHM2DU	□□□	3-pole	CHM3DU	□□□□	4-pole	CHM4DU	<table border="1"> <tr><td>□</td><td>1 pole</td><td>CHPV1U</td></tr> <tr><td>□□</td><td>2-pole</td><td>CHPV2U</td></tr> <tr><td>□□□</td><td>3-pole</td><td>N/A</td></tr> <tr><td>□□□□</td><td>4-pole</td><td>N/A</td></tr> </table>	□	1 pole	CHPV1U	□□	2-pole	CHPV2U	□□□	3-pole	N/A	□□□□	4-pole	N/A	<table border="1"> <tr><td>□</td><td>1 pole</td><td>CHCC1DU</td></tr> <tr><td>□□</td><td>2-pole</td><td>CHCC2DU</td></tr> <tr><td>□□□</td><td>3-pole</td><td>CHCC3DU</td></tr> <tr><td>□□□□</td><td>4-pole</td><td>N/A</td></tr> </table>	□	1 pole	CHCC1DU	□□	2-pole	CHCC2DU	□□□	3-pole	CHCC3DU	□□□□	4-pole	N/A
□	1 pole	CHM1DU																																					
□□	2-pole	CHM2DU																																					
□□□	3-pole	CHM3DU																																					
□□□□	4-pole	CHM4DU																																					
□	1 pole	CHPV1U																																					
□□	2-pole	CHPV2U																																					
□□□	3-pole	N/A																																					
□□□□	4-pole	N/A																																					
□	1 pole	CHCC1DU																																					
□□	2-pole	CHCC2DU																																					
□□□	3-pole	CHCC3DU																																					
□□□□	4-pole	N/A																																					
With Neutral Pole and Indicator	<table border="1"> <tr><td>□□</td><td>2-pole</td><td>CHM1DNIU</td></tr> <tr><td>□□□□</td><td>4-pole</td><td>CHM3DNIU</td></tr> </table>	□□	2-pole	CHM1DNIU	□□□□	4-pole	CHM3DNIU	<table border="1"> <tr><td>□□</td><td>2-pole</td><td>N/A</td></tr> <tr><td>□□□□</td><td>4-pole</td><td>N/A</td></tr> </table>	□□	2-pole	N/A	□□□□	4-pole	N/A	<table border="1"> <tr><td>□□</td><td>2-pole</td><td>N/A</td></tr> <tr><td>□□□□</td><td>4-pole</td><td>N/A</td></tr> </table>	□□	2-pole	N/A	□□□□	4-pole	N/A																		
□□	2-pole	CHM1DNIU																																					
□□□□	4-pole	CHM3DNIU																																					
□□	2-pole	N/A																																					
□□□□	4-pole	N/A																																					
□□	2-pole	N/A																																					
□□□□	4-pole	N/A																																					
With Neutral Pole and no Indicator	<table border="1"> <tr><td>□□</td><td>2-pole</td><td>CHM1DNU</td></tr> <tr><td>□□□□</td><td>4-pole</td><td>CHM3DNU</td></tr> </table>	□□	2-pole	CHM1DNU	□□□□	4-pole	CHM3DNU	<table border="1"> <tr><td>□□</td><td>2-pole</td><td>N/A</td></tr> <tr><td>□□□□</td><td>4-pole</td><td>N/A</td></tr> </table>	□□	2-pole	N/A	□□□□	4-pole	N/A	<table border="1"> <tr><td>□□</td><td>2-pole</td><td>N/A</td></tr> <tr><td>□□□□</td><td>4-pole</td><td>N/A</td></tr> </table>	□□	2-pole	N/A	□□□□	4-pole	N/A																		
□□	2-pole	CHM1DNU																																					
□□□□	4-pole	CHM3DNU																																					
□□	2-pole	N/A																																					
□□□□	4-pole	N/A																																					
□□	2-pole	N/A																																					
□□□□	4-pole	N/A																																					
Neutral only 48Vdc/30A	<table border="1"> <tr><td>□</td><td>1 pole</td><td>CHM1DNXU</td></tr> <tr><td>□</td><td>1 pole</td><td>CHM1DI-48U</td></tr> </table>	□	1 pole	CHM1DNXU	□	1 pole	CHM1DI-48U	<table border="1"> <tr><td>□</td><td>1 pole</td><td>N/A</td></tr> <tr><td>□</td><td>1 pole</td><td>N/A</td></tr> </table>	□	1 pole	N/A	□	1 pole	N/A	<table border="1"> <tr><td>□</td><td>1 pole</td><td>N/A</td></tr> <tr><td>□</td><td>1 pole</td><td>CHCC1DI-48U</td></tr> </table>	□	1 pole	N/A	□	1 pole	CHCC1DI-48U																		
□	1 pole	CHM1DNXU																																					
□	1 pole	CHM1DI-48U																																					
□	1 pole	N/A																																					
□	1 pole	N/A																																					
□	1 pole	N/A																																					
□	1 pole	CHCC1DI-48U																																					
Mounting Rail	<table border="1"> <tr><td>⌋</td><td>DRL35MMHI</td></tr> <tr><td>⌋</td><td>DRL35MML0</td></tr> </table>	⌋	DRL35MMHI	⌋	DRL35MML0	<table border="1"> <tr><td>⌋</td><td>DRL35MMHI</td></tr> <tr><td>⌋</td><td>DRL35MML0</td></tr> </table>	⌋	DRL35MMHI	⌋	DRL35MML0	<table border="1"> <tr><td>⌋</td><td>DRL35MMHI</td></tr> <tr><td>⌋</td><td>DRL35MML0</td></tr> </table>	⌋	DRL35MMHI	⌋	DRL35MML0																								
⌋	DRL35MMHI																																						
⌋	DRL35MML0																																						
⌋	DRL35MMHI																																						
⌋	DRL35MML0																																						
⌋	DRL35MMHI																																						
⌋	DRL35MML0																																						
Tools																																							

Features and Benefits

- Easily distribute power in single-phase or three-phase configurations
- Flexible cut-to-length solutions without compromising on the product's finger-safe features
- 100kA SCCR (Short-Circuit Current Rating) when protected by a 200A Class J fuse
- Single-phase bus bars rated to 1000Vdc and 100A in end-fed configuration (200A for center-fed configuration)
- Three-phase bus bars rated to 600Vac/dc and 100A in end-fed configuration (200A for center-fed configuration)
- Power feed terminals for single-phase and three-phase service

Comb-Bus Bar Accessories



Selection guide

Part Number	Description
BB1P100M3	Single-phase 1000Vdc busbar, 100A, 3 pins, assembled endcap
BB1P100M6	Single-phase 1000Vdc busbar, 100A, 6 pins, assembled endcap
BB1P100M9	Single-phase 1000Vdc busbar, 100A, 9 pins, assembled endcap
BB1P100M12	Single-phase 1000Vdc busbar, 100A, 12 pins, assembled endcap
BB1P100M15	Single-phase 1000Vdc busbar, 100A, 15 pins, assembled endcap
BB1P100M57	Single-phase 1000Vdc cuttable busbar, 100A, 57 pins, without endcap
BB3P100M6	Three-phase 600V busbar, 100A, 6 pins, assembled endcap
BB3P100M9	Three-phase 600V busbar, 100A, 9 pins, assembled endcap
BB3P100M12	Three-phase 600V busbar, 100A, 12 pins, assembled endcap
BB3P100M15	Three-phase 600V busbar, 100A, 15 pins, assembled endcap
BB3P100M57	Three-phase 600V cuttable busbar, 100A, 57 pins, without endcap
ECAP1P	Single-phase busbar endcap
ECAP1P	Three-phase busbar endcap
PWR35MM	35mm ² feeder terminal for three-phase busbar (115A, 1000Vac/dc)
FSCVR	Spare contact safety protection covers
PWR1PLP	Single-phase low-profile feeder terminal (115A, 1000Vac/dc)
PWR50MM	50mm ² direct feed terminal (1000Vac/dc)

Modular Fuse Holder Accesories

Specifications

Agency Information:

UL 508, File E195399

Pitch: 17.8mm

Max Current:

100A (power feed from end)

200A (power feed from center)

Max Voltage:

600Vac (three phase)

1000Vdc/600Vac (single phase)

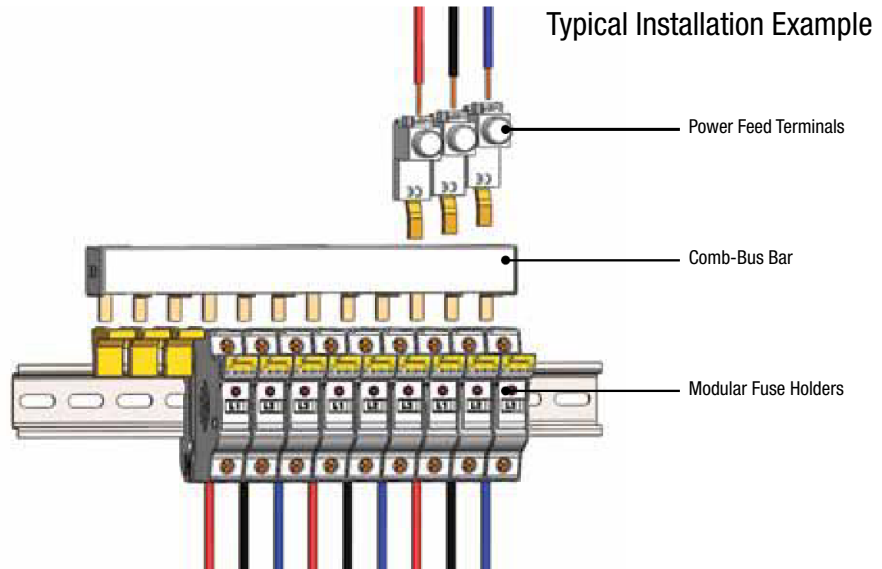

Typical Dimensional Data - mm

Three-phase

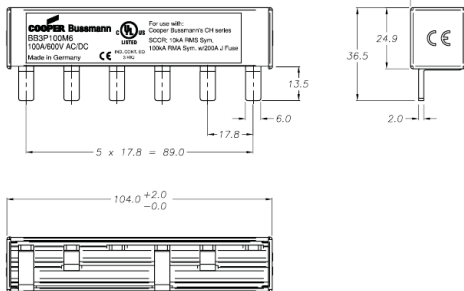

Single-phase

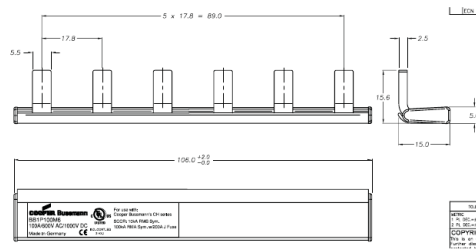

ECAP1P

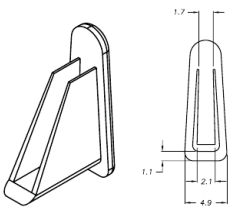

ECAPMP

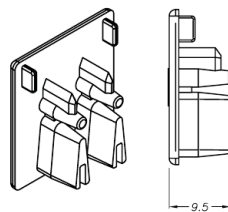

FSCVR

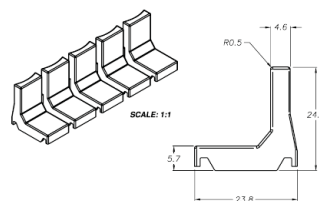

PWR1PLP

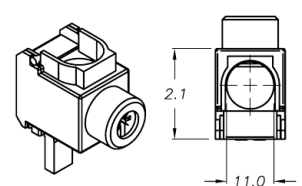

PWR35MM

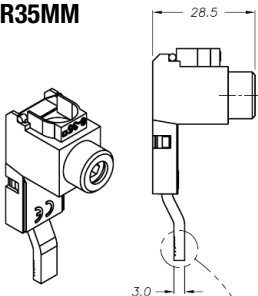

PWR50MM

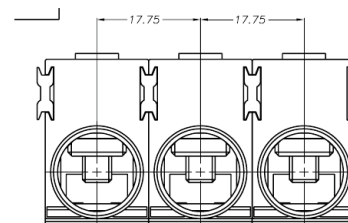
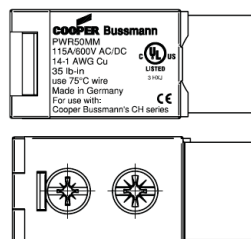

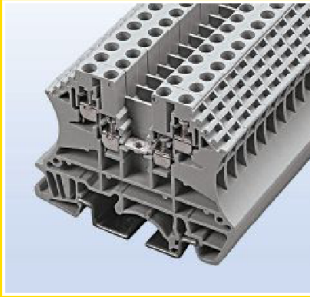

DDNS Series

The DDNS10 is an internally jumpered terminal block. Internally jumpered double-level terminal blocks provide high-density power distribution in 3-in/1-out or 2-in/2-out or 1-in/3-out options with a single block. Add top and side insertion bridges to achieve any connection topology. IEC60947-7 and UL1059 compliant.

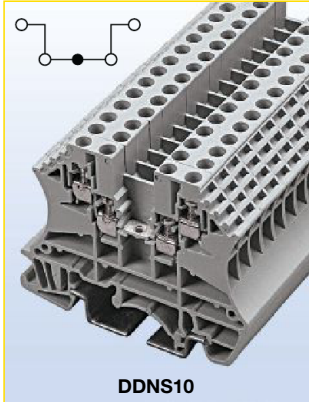

DDNS10

Approval		
Technical Data	UL	IEC
Rated voltage	300V	630V
Rated current	10A	17.5A
Conductor cross-section, solid (AWG/mm ²)	22~14 / 0.5~1.5	
Conductor cross-section, flexible (AWG/mm ²)	22~14 / 0.5~1.5	
Rated impulse withstand voltage	8kV	
Torque(N•m)	0.4	
Torque(lb-in)	3.5	
Screw	M2.5	
Wire strip length(mm)	6~7	
WxHxD(mm)	5.1 x 46.8 x 58.9	

Colors	Cat. No.
● Grey	DDNS10-GY

Accessories	Cat. No.
● Grey	DDNS10-GY-ND

2-pole	N/A
3-pole	N/A
4-pole	N/A
10-pole	N/A

2-pole	CSC-2-502P
3-pole	CSC-2-503P
4-pole	CSC-2-504P
10-pole	CSC-2-510P

2-pole	DS2-5-02P
3-pole	DS2-5-03P
4-pole	DS2-5-04P
10-pole	DS2-5-10P

	TM26CB
--	--------

	DRL32MMG
	DRL35MMHI
	DRL35MMLLO

	0.4 x 2.5mm
--	-------------

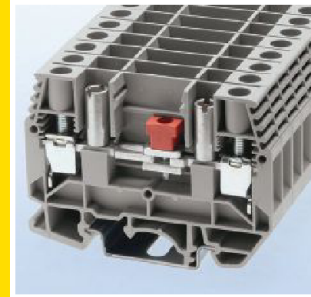
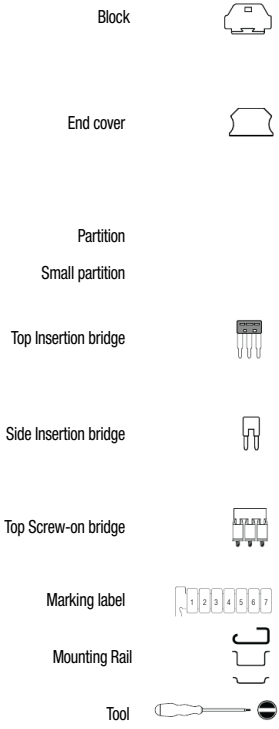

DTST2 Series

Test Terminal Blocks

Test terminal blocks with convenient test sockets, plugs, jumpers and accessories to make your circuit troubleshooting easy.



DTST2

Approval		
Technical Data	UL	IEC
Rated voltage	300V/600V	660V
Rated current	48A/5A	41A
Conductor cross-section, solid (AWG/mm ²)	20~8 / 0.5~6	
Conductor cross-section, flexible (AWG/mm ²)	20~8 / 0.5~6	
Rated impulse withstand voltage	6kV	
Torque(N•m)	2	
Torque(lb-in)	17.7	
Screw	M4	
Wire strip length(mm)	8	
WxHxD(mm)	8 x 65.6 x 47.5	

Colors	Cat. No.
● Grey	DTST2-GY

Accessories	Cat. No.
● Grey	DTST-GY-ND

	DKSPS-006
--	-----------

2-pole	DS6A02
3-pole	DS6A03

	C002-0101-BK
	C002-0101-RD

	DS6S1-BK
	DS6S1-OR
	DS6S1-YW
	DS6S1-RD

	C002-0201
--	-----------

	C002-0301
--	-----------

2-pole	CSC-602P
3-pole	CSC-603P
4-pole	CSC-604P
10-pole	CSC-610P

2-pole	DS6-02P
3-pole	DS6-03P
4-pole	DS6-04P
10-pole	DS6-10P

	TM28CB
--	--------

	DRL32MMG
	DRL35MMHI
	DRL35MMLLO

	0.6 x 3.5mm
--	-------------

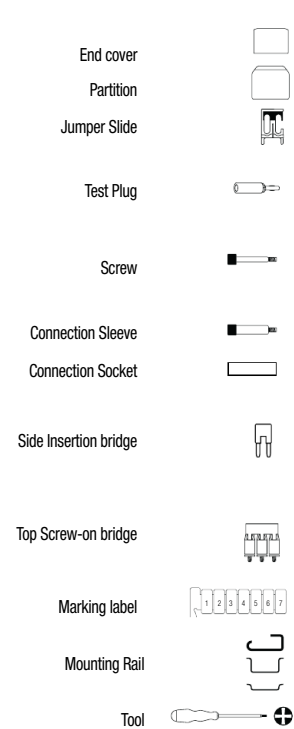





Panel Mount Blocks





Panel Mount Series

Flexible alternative to barrier strips with screw and spring-cage wiring connections for feed through and one-to-two power distribution. Use side insertion bridge to achieve any connection topology.

- Block 
- End cover 
- Side Insertion bridge 
- Marking label 
- Tool 



Approval  		
Technical Data	UL	IEC
Rated voltage	300V	500V
Rated current	20A	24A
Conductor cross-section, solid (AWG/mm ²)	22~12 / 0.5~2.5	
Conductor cross-section, flexible (AWG/mm ²)	22~12 / 0.5~2.5	
Rated impulse withstand voltage	7kV	
Torque(N•m)	0.39	
Torque(lb-in)	3.5	
Screw	M2.5	
Wire strip length(mm)	6~8	
WxHxD(mm)	5.1 x 20 x 22	



Colors	Cat. No.
● Grey	P20S-GY-01

Accessories	Cat. No.
● Grey	P20S-GY-ND

2-pole	CSC-2-502PS
3-pole	CSC-2-503PS
4-pole	CSC-2-504PS
10-pole	CSC-2-510PS

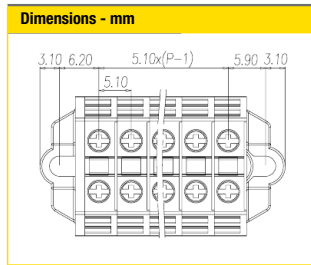
Marking label	Cat. No.
	TM20CB



Approval  		
Technical Data	UL	IEC
Rated voltage	300V	500V
Rated current	30A	32A
Conductor cross-section, solid (AWG/mm ²)	22~10 / 0.5~4	
Conductor cross-section, flexible (AWG/mm ²)	22~10 / 0.5~4	
Rated impulse withstand voltage	7kV	
Torque(N•m)	0.49	
Torque(lb-in)	4.3	
Screw	M3	
Wire strip length(mm)	6~8	
WxHxD(mm)	6.1 x 22 x 23	



Colors	Cat. No.
● Grey	P30S-GY-01

Accessories	Cat. No.
● Grey	P30S-GY-ND

2-pole	CSC-402PS
3-pole	CSC-403PS
4-pole	CSC-404PS
10-pole	CSC-410PS

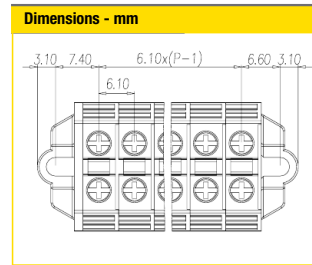
Marking label	Cat. No.
	TM21CB



Approval  		
Technical Data	UL	IEC
Rated voltage	300V	500V
Rated current	65A	41A
Conductor cross-section, solid (AWG/mm ²)	20~6 / 1.5~6	
Conductor cross-section, flexible (AWG/mm ²)	20~6 / 1.5~6	
Rated impulse withstand voltage	8kV	
Torque(N•m)	1.18	
Torque(lb-in)	10.4	
Screw	M4	
Wire strip length(mm)	9~11	
WxHxD(mm)	8 x 29.8 x 30	

Colors	Cat. No.
● Grey	P65S-GY-01

Accessories	Cat. No.
● Grey	P65S-GY-ND

2-pole	CSC-602PS
3-pole	CSC-603PS
4-pole	CSC-604PS
10-pole	CSC-610PS

Marking label	Cat. No.
	TM22CB

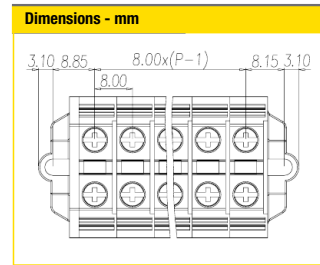

Panel Mount Blocks

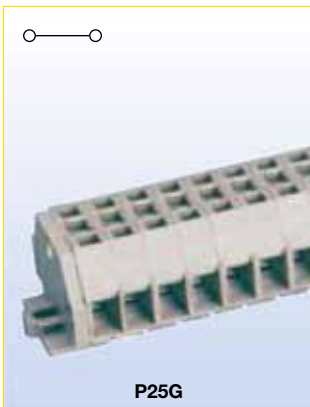

P25G



2P25G

Approval c US

Technical Data	UL	IEC
Rated voltage	600V	660V
Rated current	25A	24A
Conductor cross-section, solid (AWG/mm ²)	28-12 / 0.5-2.5	
Conductor cross-section, flexible (AWG/mm ²)	14-12 / 0.5-2.5	
Rated impulse withstand voltage	8kV	
Torque(N•m)	Spring Clamp	
Torque(lb-in)	Spring Clamp	
Screw	N/A	
Wire strip length(mm)	7-8	
WxHxD(mm)	6 x 28 x 18	

Colors **Cat. No.**

● Grey P25G-GY-01

Accessories **Cat. No.**

● Grey P25G-GY-ND

2-pole	DS-204
3-pole	N/A
4-pole	N/A
10-pole	N/A
	TM20CB
	0.4 x 2.5mm

Approval c US

Technical Data	UL	IEC
Rated voltage	600V	660V
Rated current	25A	24A
Conductor cross-section, solid (AWG/mm ²)	28-12 / 0.5-2.5	
Conductor cross-section, flexible (AWG/mm ²)	14-12 / 0.5-2.5	
Rated impulse withstand voltage	8kV	
Torque(N•m)	Spring Clamp	
Torque(lb-in)	Spring Clamp	
Screw	N/A	
Wire strip length(mm)	7-8	
WxHxD(mm)	10 x 28 x 18	

Colors **Cat. No.**

● Grey 2P25G-GY-01

Accessories **Cat. No.**

● Grey P25G-GY-ND

2-pole	DS-204
3-pole	N/A
4-pole	N/A
10-pole	N/A
	TM20CB
	0.4 x 2.5mm



NDN Series Feed Through Blocks



NDN Series

The NDN Series features a compact line of rail-mounted terminal blocks suitable for both 35mm DIN-Rail or C-Rail applications. Products easily snap onto the mounting rail for a quick, simple, low-cost solution. Available accessories include jumpers and marking tape.

UL E62622
CSA File 15364
CSA File 47235 (NDN1, NDN111)

- Block 
- Jumper
- Marking Tape
- Mounting
- Modular Option



NDNV4

Approval 	
Technical Data	
Rated voltage	600V
Rated Current	30A
Center spacing, in (mm)	0.25 / 6.35
Conductor cross-section, flexible (AWG/mm ²)	22-10 / 0.5-6
Number of Poles	4
Circuits per foot	48
Torque(N•m)	2
Torque(lb-in)	18
Screw	#6-32
WxHxD(mm)	25.4 x 34 x 42.4

Colors	Cat. No.
○ White (Standard)	NDNV4-WH
● Black	NDNV4-BK
● Yellow	NDNV4-YE

Accessories	Cat. No.
4 circuits	JN4
	MTC6
35mm DIN-Rail	DRL35MML0 DRL35MMHI
C-Rail	NFTA Series
C-Rail (low profile)	NRA Series
	N/A

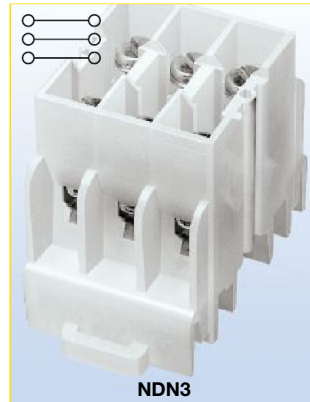
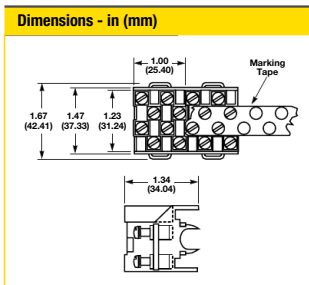

NDN3

Approval 	
Technical Data	
Rated voltage	600V
Rated Current	30A
Center spacing, in (mm)	0.3 / 7.62
Conductor cross-section, flexible (AWG/mm ²)	22-10 / 0.5-6
Number of Poles	3
Circuits per foot	38
Torque(N•m)	2
Torque(lb-in)	18
Screw	#6-32
WxHxD(mm)	23.9 x 33.3 x 42.4

Colors	Cat. No.
○ White (Standard)	NDN3-WH
● Black	NDN3-BK
● Blue	NDN3-BL
● Yellow	NDN3-YE
● Red	NDN3-RE

Accessories	Cat. No.
2 circuits	JNDN3
	MT12-1-2
35mm DIN-Rail	DRL35MML0 DRL35MMHI
C-Rail	NFTA Series
C-Rail (low profile)	NRA Series
	N/A

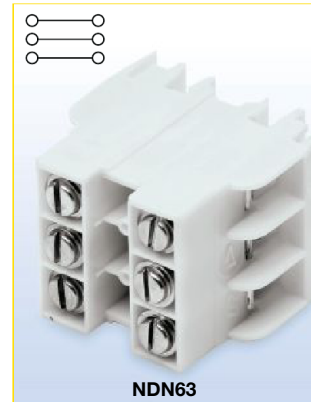
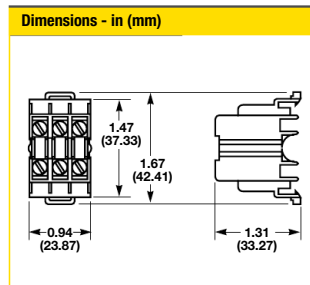

NDN63

Approval 	
Technical Data	
Rated voltage	600V
Rated Current	65A
Center spacing, in (mm)	0.375 / 9.52
Conductor cross-section, flexible (AWG/mm ²)	18-6 / 1-16
Number of Poles	3
Circuits per foot	30
Torque(N•m)	4
Torque(lb-in)	35
Screw	#10-32
WxHxD(mm)	29.7 x 36.8 x 42.4

Colors	Cat. No.
○ White (Standard)	NDN63-WH
● Black	NDN63-BK
● Yellow	NDN63-YE

Accessories	Cat. No.
2 circuits	JN3
	MT12-1-2
35mm DIN-Rail	DRL35MML0 DRL35MMHI
C-Rail	NFTA Series
C-Rail (low profile)	NRA Series
	N/A

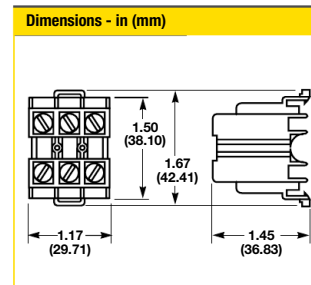

NDN Series Feed Through Blocks



NDN1

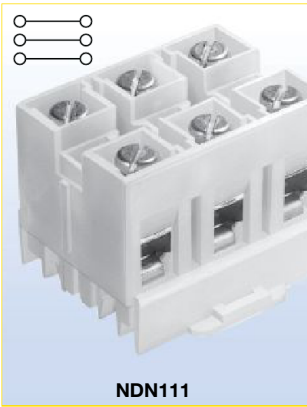

NDN111

Approval  

Technical Data	
Rated voltage	600V
Rated Current	90A
Center spacing in (mm)	0.635 / 16.31
Conductor cross-section, flexible (AWG/mm ²)	18-2 / 1-35
Number of Poles	1
Circuits per foot	18
Torque(N•m)	3.6
Torque(lb-in)	32
Screw	1/4-28
WxHxD(mm)	15 x 30.3 x 43.5

Colors **Cat. No.**

○ White (Standard) NDN1-WH

Accessories **Cat. No.**

	MT12-1-2
35mm DIN-Rail	DRL35MML0 DRL35MMHI
C-Rail	NFTA Series
C-Rail (low profile)	NRA Series
	NDN1A-WH

Dimensions - in (mm)

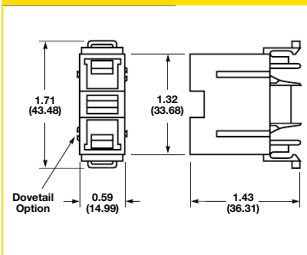

Approval  

Technical Data	
Rated voltage	600V
Rated Current	90A
Center spacing in (mm)	0.635 / 16.31
Conductor cross-section, flexible (AWG/mm ²)	18-2 / 1-35
Number of Poles	3
Circuits per foot	18
Torque(N•m)	3.6
Torque(lb-in)	32
Screw	1/4-28
WxHxD(mm)	47.5 x 36.6 x 43.5

Colors **Cat. No.**

○ White (Standard) NDN111-WH

● Black NDN111-BK

● Blue NDN111-BL

● Yellow NDN111-YE

● Red NDN111-RE

Accessories **Cat. No.**

2 circuits	JN1
	MT12-1-2
35mm DIN-Rail	DRL35MML0 DRL35MMHI
C-Rail	NFTA Series
C-Rail (low profile)	NRA Series
	NDN111A-WH, NDN111A-BK, NDN111A-YE

Dimensions - in (mm)

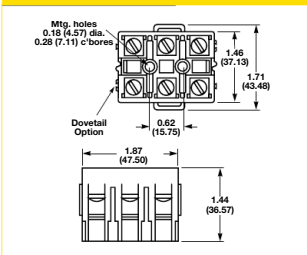

C-Rail Feed Through Blocks



C-Rail Series

C-Rail terminal blocks provide a low-profile, compact foot-print solution for various wire connection applications. Products feature an easy, snap-on installation method and an array of accessories including jumpers and marking strips.

UL E62622 (excluding N512)
 CSA File 15364
 CSA File 47235 (NFT3)

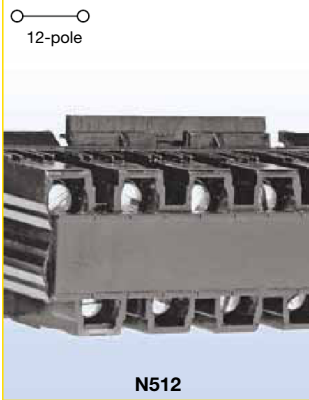

Approval		SP	
Technical Data			
Rated voltage	300V	600V	
Rated current	20A	5A	
Center spacing in (mm)	0.197 / 5.0		
Conductor cross-section, flexible (AWG/mm ²)	22-12 / 0.3-3.3		
Number of Poles	12		
Circuits per foot	60		
Torque(N•m)	1.4		
Torque(lb-in)	12		
Screw	#4-48		
WxHxD(mm)	61.0 x 27.7 x 22.4		

Colors	Cat. No.
● Black (Standard)	N512-BK

Accessories	Cat. No.
12 circuits	JN512
Marking Tape	AT512
15mm DIN-Rail	DRL15MM
C-Rail	NFTA Series
C-Rail (low profile)	NRA Series

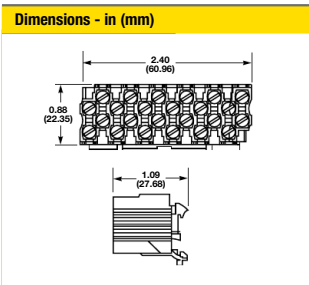

Approval		UL SP	
Technical Data			
Rated voltage	600V		
Rated Current	40A		
Center spacing in (mm)	0.28 / 7.13		
Conductor cross-section, flexible (AWG/mm ²)	22-8 / 0.3-8.4		
Number of Poles	2		
Circuits per foot	38		
Torque(N•m)	2		
Torque(lb-in)	18		
Screw	#8-32		
WxHxD(mm)	16.5 x 34.7 x 42.8		

Colors	Cat. No.
○ White (Standard)	NFT2-WH
● Black	NFT2-BK
● Blue	NFT2-BL
● Red	NFT2-RE

Accessories	Cat. No.
2 circuits	JN2
Marking Tape	MT12-1-2
C-Rail	NFTA Series
C-Rail (low profile)	NRA Series

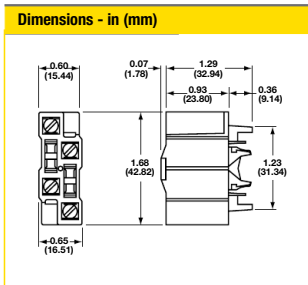

Approval		UL SP	
Technical Data			
Rated voltage	600V		
Rated Current	40A		
Center spacing in (mm)	0.39 / 9.91		
Conductor cross-section, flexible (AWG/mm ²)	22-8 / 0.3-8.4		
Number of Poles	3		
Circuits per foot	28		
Torque(N•m)	2		
Torque(lb-in)	18		
Screw	#8-32		
WxHxD(mm)	30.0 x 32.9 x 31.4		

Colors	Cat. No.
○ White (Standard)	NFT3-WH
● Black	NFT3-BK
● Blue	NFT3-BL
● Yellow	NFT3-YE
● Red	NFT3-RE

Accessories	Cat. No.
2 circuits	JN3
Marking Tape	MT12-1-2
C-Rail	NFTA Series
C-Rail (low profile)	NRA Series

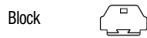
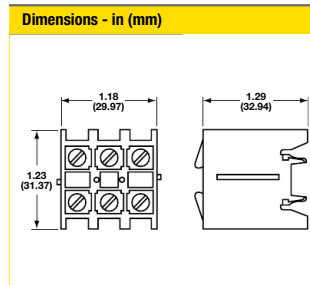

- Jumper
- Marking Tape
- Mounting

C-Rail Feed Through Blocks



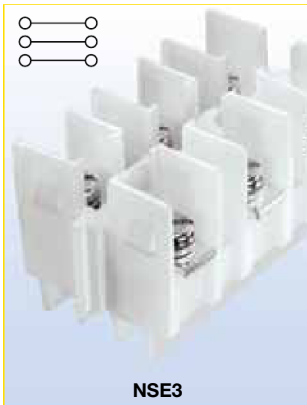

NC3







NSE3



NSS3

Approval  	
Technical Data	
Rated voltage	600V
Rated Current	175A
Center spacing in (mm)	1.06 / 26.92
Conductor cross-section, flexible (AWG/mm ²)	14-2/0 / 2.1-67.4 Cu/AL
Number of Poles	3
Circuits per foot	11
Torque(N•m)	5.1
Torque(lb-in)	45
Screw	5/16 - 24
WxHxD(mm)	79.4 x 44.5 x 44.5
Colors	Cat. No.
○ White (Standard)	NC3-WH
● Black	NC3-BK

Approval  	
Technical Data	
Rated voltage	600V
Rated Current	115A
Center spacing in (mm)	1.06 / 26.92
Conductor cross-section, flexible (AWG/mm ²)	Ring Terminals Only
Number of Poles	3
Circuits per foot	11
Torque(N•m)	3.6
Torque(lb-in)	32
Screw	1/4 - 28
WxHxD(mm)	79.2 x 38.9 x 44.5
Colors	Cat. No.
○ White (Standard)	NSE3-WH

Approval  	
Technical Data	
Rated voltage	600V
Rated Current	30A
Center spacing in (mm)	0.385 / 9.77
Conductor cross-section, flexible (AWG/mm ²)	Ring Terminals Only
Number of Poles	3
Circuits per foot	28
Torque(N•m)	1.4
Torque(lb-in)	12
Screw	#6-32
WxHxD(mm)	31.5 x 33.7 x 31.8
Colors	Cat. No.
○ White (Standard)	NSS3-WH
● Black	NSS3-BK

Accessories	Cat. No.
Panel Mount C-Rail	NFTA Series
C-Rail (low profile)	NRA Series

Accessories	Cat. No.
2 circuits	JNSE3
Panel Mount C-Rail	NFTA Series
C-Rail (low profile)	NRA Series

Accessories	Cat. No.
2 circuits	JNSS3
Panel Mount C-Rail	NFTA Series
C-Rail (low profile)	NRA Series

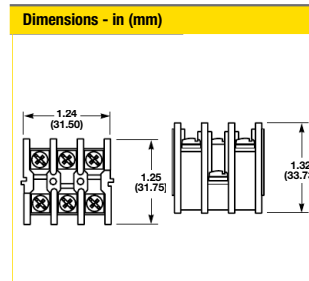
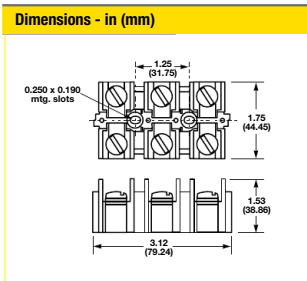
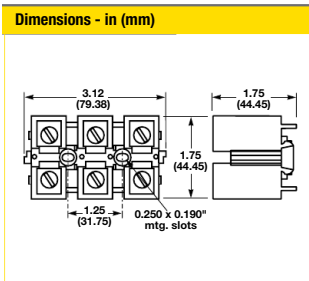

Depluggable Blocks

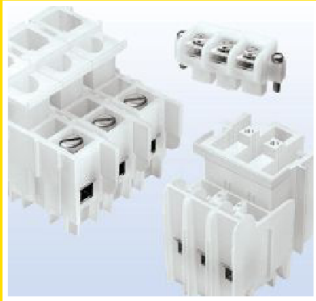

Depluggable Blocks

Depluggable terminal blocks are available for both 35mm DIN-Rail and C-Rail applications. These blocks provide a simple depluggable* option for panel wiring applications with the convenience of quick, easy, snap-on installation. Product accessories, such as jumpers and marking tape, are available for most products.

UL E62622
 CSA File 15364
 CSA File 47235 (15188 Series)

*Not for use as a load break disconnect.

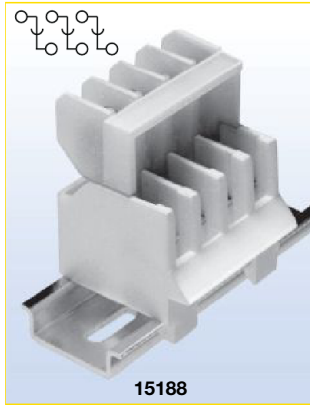

15188

Approval	
Technical Data	
Rated voltage	600V
Rated Current	30A
Center spacing in (mm)	0.375 / 9.52
Conductor cross-section, flexible (AWG/mm ²)	16-12 / 1.5-4
Number of Poles	3 or 4
Circuits per foot	32
Torque(N•m)	1.4
Torque(lb-in)	12
Screw	#6-32
WxHxD(mm)	
3-Pole	30.2 x 49.3 x 47.8
4-Pole	39.2 x 49.3 x 47.8

Colors	Cat. No.
○ White (Standard)	15188-3
○ White (Standard)	15188-4

Accessories	Cat. No.
2 circuits	15188J-2-J
35mm DIN-Rail	DRL35MML0 DRL35MMHI

Reverse Wiring	15188- <u>R</u>
Locking	15188- <u>S</u>
Reverse; Locking	15188- <u>RS</u>

Options offered for both pole lengths

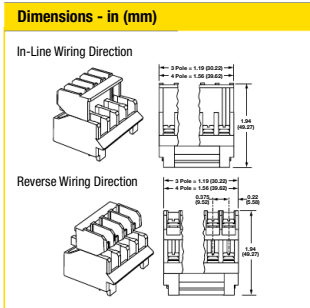

15288

Approval	
Technical Data	
Rated voltage	600V
Rated Current	65A
Center spacing in (mm)	0.54 / 13.7
Conductor cross-section, flexible (AWG/mm ²)	16-6 / 1.5-16
Number of Poles	3
Circuits per foot	22
Torque(N•m)	2.3
Torque(lb-in)	20
Screw	#8-32
WxHxD(mm)	
	43.2 x 49.3 x 47.9
	N/A

Colors	Cat. No.
○ White (Standard)	15288

Accessories	Cat. No.
35mm DIN-Rail	DRL35MML0 DRL35MMHI

Reverse Wiring	15288-R
Screw Together	15288-ST
Locking	15288-S

Options may be combined

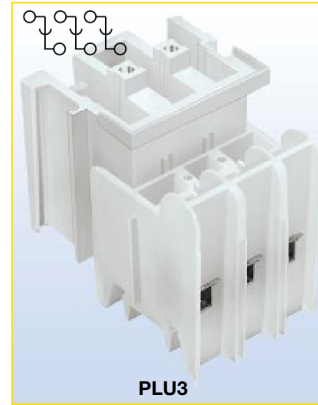
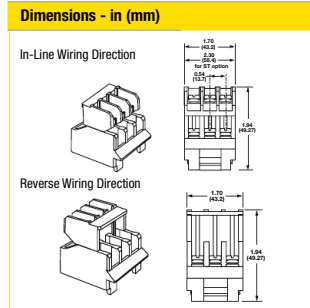

PLU3

Approval	
Technical Data	
Rated voltage	600V
Rated Current	40A
Center spacing in (mm)	0.39 / 9.91
Conductor cross-section, flexible (AWG/mm ²)	22-8 / 0.5-10
Number of Poles	3
Circuits per foot	28
Torque(N•m)	2
Torque(lb-in)	18
Screw	#8-32
WxHxD(mm)	
	31.8 x 47.0 x 45.6
	N/A

Colors	Cat. No.
○ White (Standard)	PLU3-WH
● Black	PLU3-BK
● Yellow	PLU3-YE

Accessories	Cat. No.
2 circuits	JN3
	MT12-1-2
C-Rail (AL)	NFTA Series
C-Rail (low profile)	NRA Series

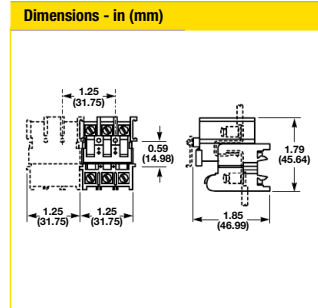



Depluggable Blocks

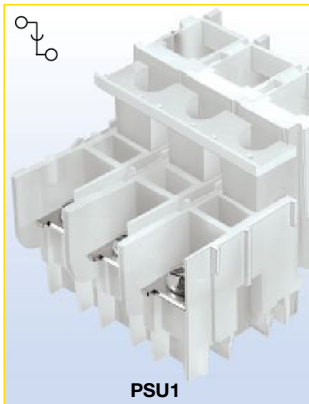

PLU1





PSU1

Approval  	
Technical Data	
Rated voltage	600V
Rated Current	70A
Center spacing in (mm)	0.625 / 15.88
Conductor cross-section, flexible (AWG/mm ²)	18-4 / 1.0-25
Number of Poles	1 - 3
Circuits per foot	19
Torque(N•m)	3.6
Torque(lb-in)	32
Screw	1/4 - 28
WxHxD(mm)	
1-Pole	18.5 x 47.0 x 45.6
2-Pole	34.0 x 47.0 x 45.6
3-Pole	49.5 x 47.0 x 45.6

Colors	Cat. No.
○ White (1-Pole)	PLU1-WH
○ White (2-Pole)	PLU11-WH
○ White (3-Pole)	PLU111-WH

Accessories	Cat. No.
2 circuits	JN1
	MT12-1-2
C-Rail (AL)	NFTA Series
C-Rail (low profile)	NRA Series

Approval  	
Technical Data	
Rated voltage	600V
Rated Current	45A
Center spacing in (mm)	0.625 / 15.88
Conductor cross-section, flexible (AWG/mm ²)	Ring Terminals Only
Number of Poles	1 - 3
Circuits per foot	19
Torque(N•m)	2.7
Torque(lb-in)	24
Screw	#10-32
WxHxD(mm)	
1-Pole	18.5 x 49.1 x 62.1
2-Pole	34.4 x 49.1 x 62.1
3-Pole	50.3 x 49.1 x 62.1

Colors	Cat. No.
○ White (1-Pole)	PSU1-WH
○ White (2-Pole)	PSU11-WH
○ White (3-Pole)	PSU111-WH

Accessories	Cat. No.
	MT12-1-2
C-Rail (AL)	NFTA Series
C-Rail (low profile)	NRA Series

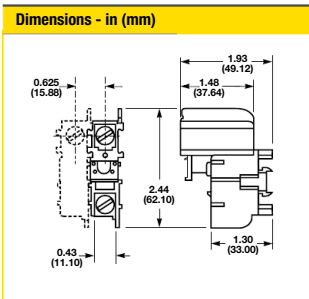
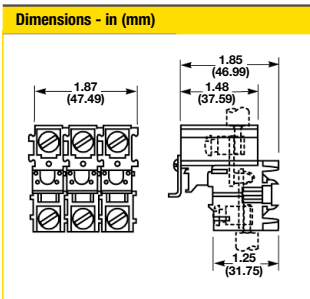

Multi-Pole Panel Mount Blocks



Panel Mount Blocks

Multi-pole panel mount terminal blocks provide a compact, high density circuit connection solution without the necessity of a mounting rail. These products are designed to be nested together to form one string of circuit connections.

UL E62622
CSA 15364 (excluding PLK3)

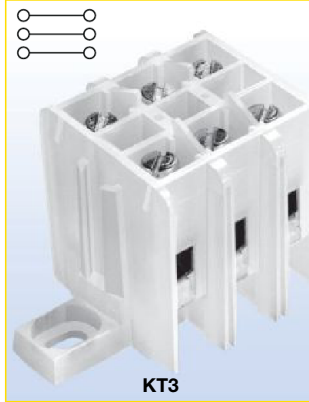

KT3

Approval	
Technical Data	
Rated voltage	600V
Rated Current	40A
Center spacing in (mm)	0.39 / 9.91
Conductor cross-section, flexible (AWG/mm ²)	22-8 / 0.5-1.0
Number of Poles	3
Circuits per foot	28
Torque(N•m)	2
Torque(lb-in)	18
Screw	#8-32
WxHxD(mm)	59.5 x 31.8 x 31.0

Colors	Cat. No.
○ White (Standard)	KT3-WH
● Black	KT3-BK
● Red	KT3-RE

Accessories	Cat. No.
2 circuits	JN3
Marking Tape	MT12-1-2
Mounting Foot	KAD

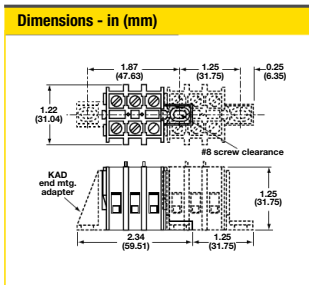

KT4

Approval	
Technical Data	
Rated voltage	600V
Rated Current	30A
Center spacing in (mm)	0.25 / 6.35
Conductor cross-section, flexible (AWG/mm ²)	22-10 / 0.5-6
Number of Poles	4
Circuits per foot	48
Torque(N•m)	2
Torque(lb-in)	18
Screw	#6-32
WxHxD(mm)	43.8 x 34.0 x 32.2

Colors	Cat. No.
○ White*	KT4-WH-A
○ White*	KT4-WH-B
● Black	KT4-BK

Accessories	Cat. No.
4 circuits	JN4
Mounting Foot	MTC6

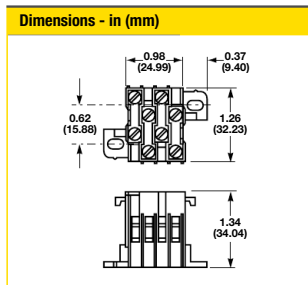

*The KT4 products are designed to be nested together to form one string of circuit connections. When used in series, order part numbers KT4-WH-A and KT4-WH-B.

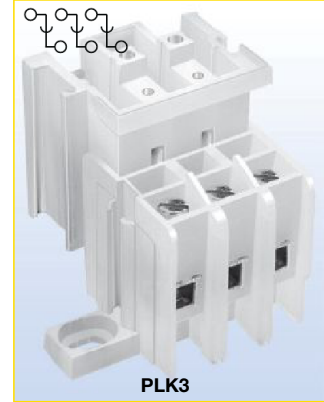

PLK3

Approval	
Technical Data	
Rated voltage	600V
Rated Current	40A
Center spacing in (mm)	0.39 / 9.91
Conductor cross-section, flexible (AWG/mm ²)	22-8 / 0.5-1.0
Number of Poles	3
Circuits per foot	28
Torque(N•m)	2
Torque(lb-in)	18
Screw	#8-32
WxHxD(mm)	65.7 x 46.9 x 45.5

Colors	Cat. No.
○ White (Standard)	PLK3-WH

Accessories	Cat. No.
2 circuits	JN3
Mounting Foot	MT12-1-2
Mounting Foot	KAD

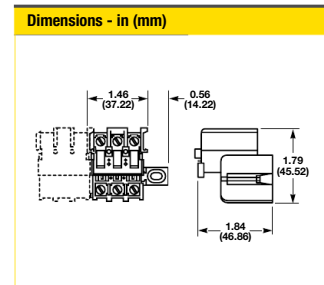

Block



Jumper
Marking Tape
Mounting

Quick Connect Blocks



Quick Connect Blocks

For a time saving alternative for electrical connections, the Cooper Bussmann quick connect terminal blocks offer a convenient solution. With male spade terminals, wire connections are made quickly and simply with these terminal blocks. Products are offered for C-Rail and panel mount applications.

UL E62622
CSA 15364 (excluding NTQ23)



Approval	
Technical Data	
Rated voltage	600V
Rated Current	40A
Center spacing in (mm)	0.39 / 9.91
Conductor cross-section, flexible (AWG/mm ²)	22-8 / 0.3-8.4
Number of Poles	3
Circuits per foot	28
Torque(N•m)	2
Torque(lb-in)	18
Screw	#8-32
WxHxD(mm)	31.8 x 31.8 x 33.2

Colors	Cat. No.
○ White (Standard)	NTQ23-WH



Approval	
Technical Data	
Rated voltage	600V
Rated Current	40A
Center spacing in (mm)	0.437 / 11.1
Conductor cross-section, flexible (AWG/mm ²)	22-8 / 0.3-8.4
Number of Poles	1
Circuits per foot	24
Torque(N•m)	2
Torque(lb-in)	18
Screw	#8-32
WxHxD(mm)	33.3 x 35.8 x 37.3

Colors	Cat. No.
○ White (Standard)	BNQ21-WH



Approval	
Technical Data	
Rated voltage	600V
Rated Current	30A
Center spacing in (mm)	0.437 / 11.1
Conductor cross-section, flexible (AWG/mm ²)	.25" Quick Connect Terminals Only
Number of Poles	1
Circuits per foot	24
Torque(N•m)	NA
Torque(lb-in)	NA
Screw	NA
WxHxD(mm)	33.3 x 35.8 x 37.3

Colors	Cat. No.
○ White (Standard)	BQQ41-WH

Block

Marking Tape
Mounting

Accessories	Cat. No.
Marking Tape	MT12-1-2
C-Rail	NFTA Series
C-Rail (low profile)	NRA Series

Accessories	Cat. No.
Mounting Foot	BQE

Accessories	Cat. No.
Mounting Foot	BQE

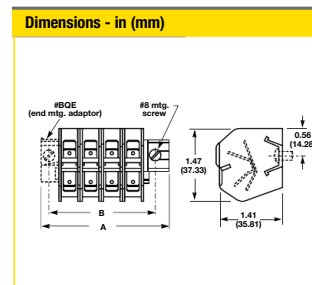
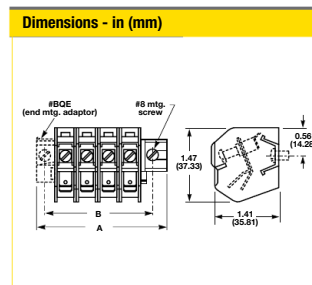
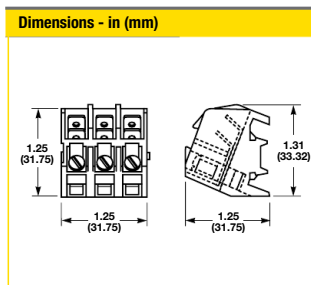

Short-Circuit Current Ratings (SCCRs)

No.	Description	Part Number*	Volts	Amps	Wire range for SCCR	SCCR Level	Fuse Class					
							RK5	RK1	J/CF	T	G	CC
1	Terminal Block	DS20-XX	600	20	12-14	100kA		30	60	60	60	30
1	End Cover	DS20-XX-ND										
2	Terminal Block	DS30-XX	600	30	10-18	100kA		30	60	60	60	30
2	End Cover	DS20-XX-ND										
3	Terminal Block	DS50-XX	600	50	8 - 18	100kA		30	60	60	60	30
3	End Cover	DS50-XX-ND										
4	Terminal Block	DM20-XX	300	20	12 - 16	100kA		30	60	60	60	30
4	End Cover	DM20-XX-ND										
5	Terminal Block	DM30-XX	300	30	10 - 16	100kA		30	60	60	60	30
5	End Cover	DM30-XX-ND										
6	Terminal Block	DM50-XX	300	50	8 - 16	100kA		30	60	60	60	30
6	End Cover	DM50-XX-ND										
7	Terminal Block	DP25-XX	600	25	12 - 18	100kA		30	60	60	60	30
7	End Cover	DP25-XX-ND										
8	Terminal Block	DP35-XX	600	35	10 - 18	100kA		30	60	60	60	30
8	End Cover	DP25-XX-ND										
9	Terminal Block	DP45-XX	600	45	8 - 18	100kA		30	60	60	60	30
9	End Cover	DP25-XX-ND										
10	Terminal Block	DP60-XX	600	60	6 - 18	100kA		30	60	60	60	30
10	End Cover	DP25-XX-ND										
11	Terminal Block	DP100-XX	600	100	14-3	200kA	30	60	100	100	60	30
11	End Cover	DP100-XX-ND										
12	Terminal Block	DP150-XX	600	150	1/0 - 12	100kA	30	100	200	200	60	30
13	Terminal Block	DP230-XX	600	230	2-4/0	200kA	60	100	200	200	60	30
14	Terminal Block	DP370-XX	600	370	300 - 500kcmil	200kA	100	200	400	400	60	30
15	Grounding Block	DG25-XX	600		12 - 18	100kA		30	60	60	60	30
16	Grounding Block	DG35-XX	600		10 - 16	100kA	30	30	60	60	60	30
17	Grounding Block	DG60-XX	600		16-8	200kA	30	60	100	100	60	30
18	Grounding Block	DG100-XX	600		14-6	200kA		60	100	100	60	30
19	Grounding Block	DG150-XX	600		12-2	200kA	30	60	100	100	60	30

* The "XX" in part number indicates color.

Short-Circuit Current Ratings (SCCRs)

No.	Description	Part Number*	Volts	Amps	Wire range for SCCR	SCCR Level	Fuse Class					
							RK5	RK1	J/CF	T	G	CC
20	Grounding Block	DG230-XX	600		2-4/0	200kA	30	60	100	100	60	30
21A	Terminal Block	DDP30-XX (upper)	300	30	10 - 18	100kA		30	60	60	60	30
21A	End Cover	DDP30-XX-ND										
21B	Terminal Block	DDP30-XX (lower)	300	30	10 - 18	100kA		30	60	60	60	30
21B	End Cover	DDP30-XX-ND										
22	Terminal Block	DDNS10-XX	300	10	16 - 18	100kA		30	60	60	60	30
22	End Cover	DDNS10-XX-ND										
23	Terminal Block	DIS10-XX	300	10	16 - 16	100kA		30	60	60	60	30
23	End Cover	DIS10-XX-ND										
24	Fuse terminal block	F520ST-XX	300	6.3	18 - 18	100kA		30	60	60	60	30
24	End Cover	F520-XX-ND										
25	Fuse terminal block	F520STLED-XX	300	6.3	18 - 18	100kA		30	60	60	60	30
25	End Cover	F520-XX-ND										
26	Fuse terminal block	F520DDST-XX (upper)	300	16	10 - 18	100kA		30	60	60	60	30
26	End Cover	F520DD-XX-ND										
27	Fuse terminal block	F520DDST-XX (lower)	300	30	10 - 18	100kA		30	60	60	60	30
27	End Cover	F520DD-XX-ND										
28	Fuse terminal block	F520TOP-XX	600	6.3	6 - 18	100kA		30	60	60	60	30
29	Terminal Block	DTST2-XX	300/600	48/5	8 - 20	100kA		30	60	60	60	30
29	End Cover	DTST-XX-ND										
30	Terminal Block	P20S-XX	300	20	12 - 16	100kA		30	60	60	60	30
30	End Cover	P20S-XX-ND										
31	Terminal Block	P30S-XX	300	30	10 - 16	100kA		30	60	60	60	30
31	End Cover	P30S-XX-ND										
32	Terminal Block	P65S-XX	300	65	6 - 16	100kA		30	60	60	60	30
32	End Cover	P65S-XX-ND										
33	Terminal Block	P25G-XX	600	25	12 - 14	100kA		30	60	60	60	30
33	End Cover	P25G-XX-ND										
34	Terminal Block	2P25G-XX	600	25	12 - 14	100kA		30	60	60	60	30
34	End Cover	P25G-XX-ND										

* The "XX" in part number indicates color.

ACCESSORIES

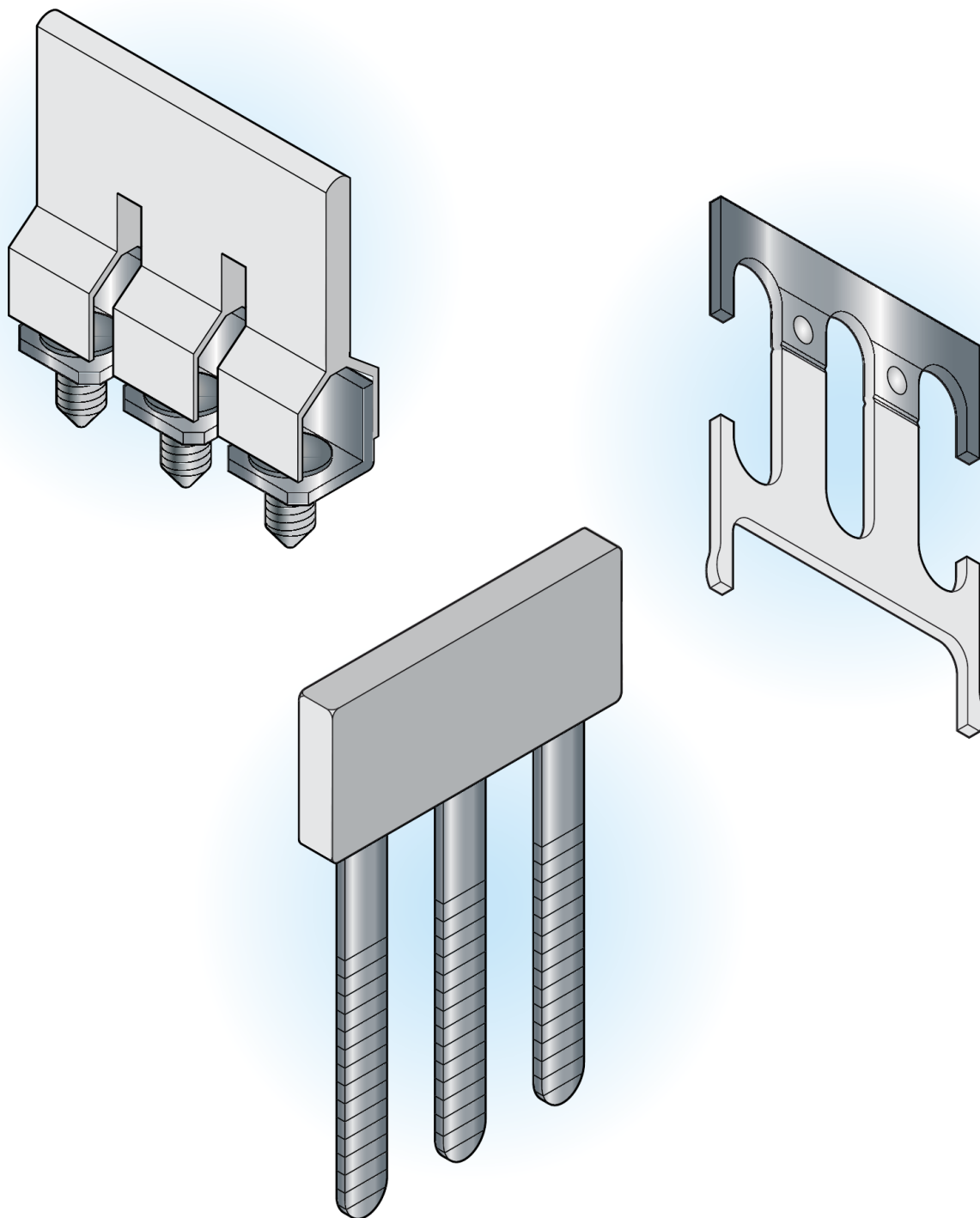

Top Screw-On Bridges

DS2-5-XXP



Use with DP25 DG25
DDNS10 DDK2.5
Poles (XX) 02, 03, 04, 10

Dimensions - mm

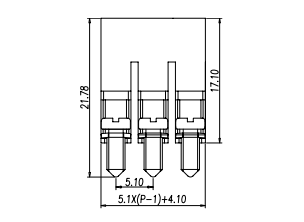

DS4-XXP



Use with DP35 DDP30
Poles (XX) 02, 03, 04, 10

Dimensions - mm

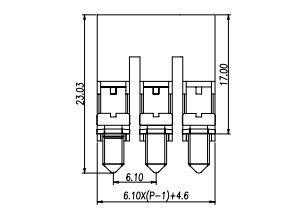

DS6-XXP



Use with DP45 DTST2
Poles (XX) 02, 03, 04, 10

Dimensions - mm

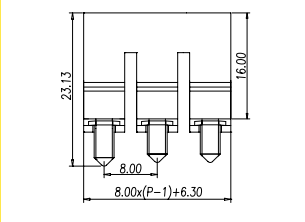

DS10-XXP



Use with DP60
Poles (XX) 02, 03, 04, 10

Dimensions - mm

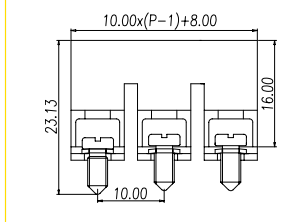

DS16 - XXP



Use with DP100
Poles (XX) 02, 03, 04, 10

Dimensions - mm

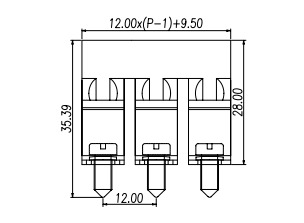

DS35 - XXP



Use with DP150
Poles (XX) 02, 03, 04, 10

Dimensions - mm

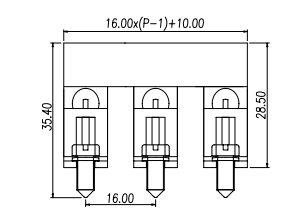

CSC-95XXP



Use with DP230
Poles (XX) 02, 03, 04, 10

Dimensions - mm

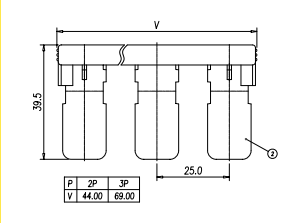

Accessories

End Brackets

BRKT-ND

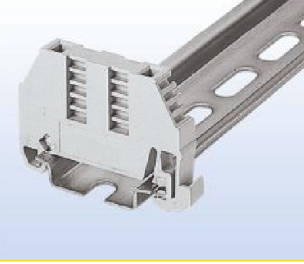

Use with	DRL35MMHI DRL35MMLO
Torque(N•m)	N/A
Torque(lb-in)	N/A
Screw	N/A

BRKT-NDSCRW

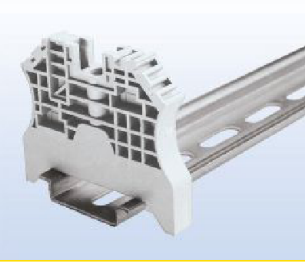

Use with	DRL35MMHI DRL35MMLO
Torque(N•m)	0.5
Torque(lb-in)	4.4
Screw	M3

BRKT-NDSCRW2

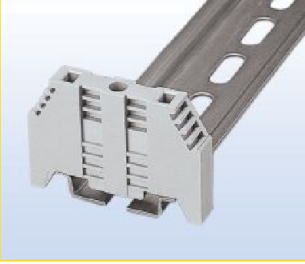

Use with	DRL35MMHI DRL35MMLO
Torque(N•m)	0.78
Torque(lb-in)	6.9
Screw	M3

BRKT-NDSCRW3

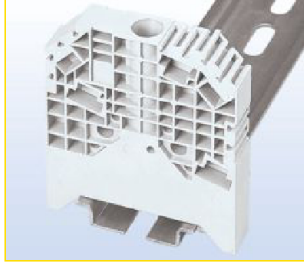

Use with	DRL35MMHI DRL35MMLO
Torque(N•m)	1.8
Torque(lb-in)	15.9
Screw	M4

Dimensions - mm

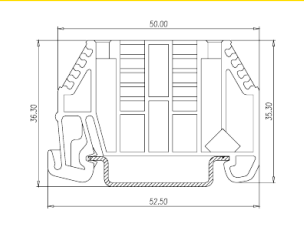

Dimensions - mm

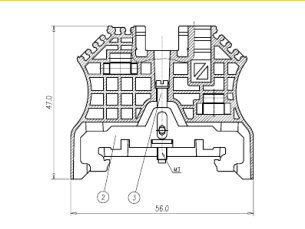

Dimensions - mm

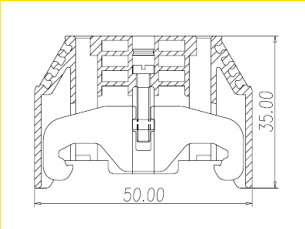

Dimensions - mm

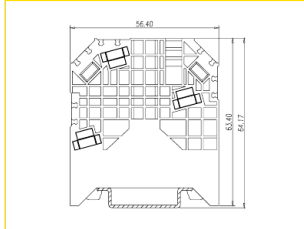

Partition Plates

DKSPS-001



Use with	DP25 DP35 DP45 DP60
----------	------------------------

DKSPS-002



Use with	DP25 DP35 DP45 DP60 DIS10
----------	---------------------------------

DKSPS-006



Use with	DTST2
----------	-------

DKNSPS-001



Use with	DS20 DS30
----------	-----------

DKNSPS-002



Use with	DS50
----------	------

DKNSPS-003



Use with	DP100
----------	-------

DKNSPS-004



Use with	DP150
----------	-------

Jumper Slides

DS6A02



Use with DTST2

Poles 02

DS6A03



Use with DTST2

Poles 03

Dimensions - mm

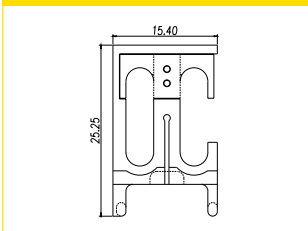

Dimensions - mm

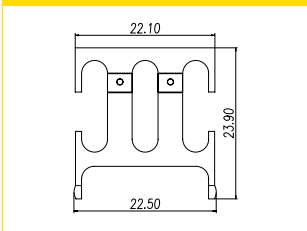

Top Insertion Bridges

DSS2-5N-XXP



Use with DS20

Poles (XX) 02, 03, 04, 10

DSS4N-XXP



Use with DS30

Poles (XX) 02, 03, 04, 10

DSS6N-XXP



Use with DS50

Poles (XX) 02, 03, 04, 10

Dimensions - mm

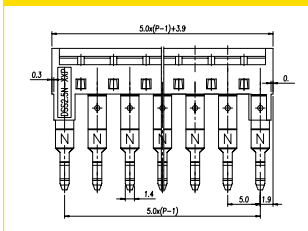

Dimensions - mm

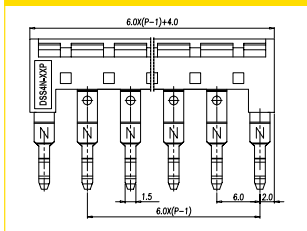

Dimensions - mm

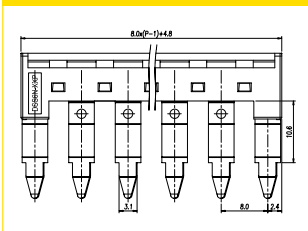

Accessories

Side Insertion Bridges

CSC-2-5XXP



Use with DP25
DIS10 P20S
DDNS10

Poles (XX) 02, 03, 04, 10

Dimensions - mm

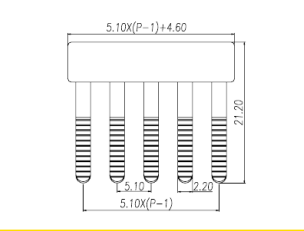

CSC-4XXP



Use with DP35
DDP30

Poles (XX) 02, 03, 04, 10

Dimensions - mm

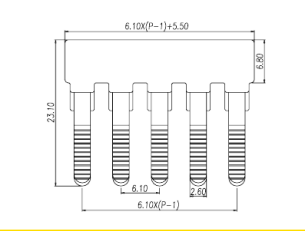

CSC-6XXP



Use with DTST2 DP45

Poles (XX) 02, 03, 04, 10

Dimensions - mm

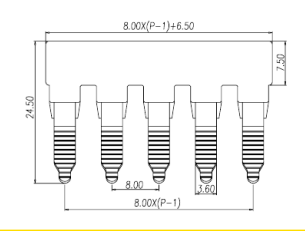

CSC-10XXP

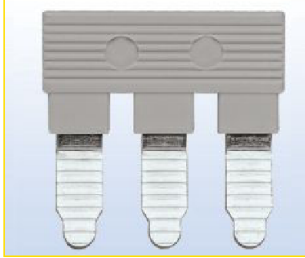

Use with DP60

Poles (XX) 02, 03, 04, 10

Dimensions - mm

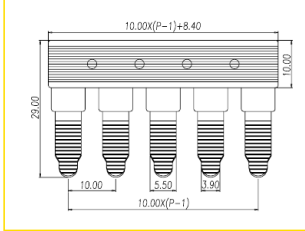

CSC-16XXP



Use with DP100

Poles (XX) 02, 03, 04, 10

Dimensions - mm

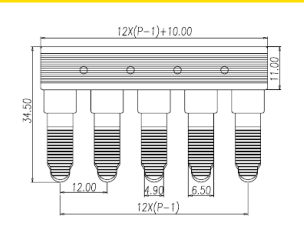

CSC-35XXP

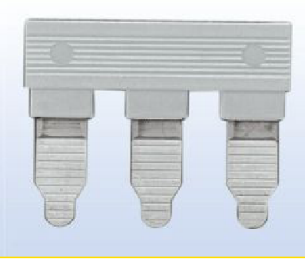

Use with DP150

Poles (XX) 02, 03, 04, 10

Dimensions - mm

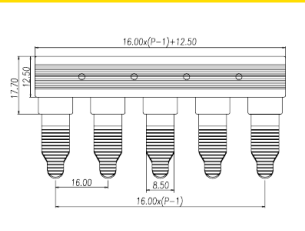

CSC-95XXP



Use with DP230

Poles (XX) 02, 03, 04, 10

Dimensions - mm

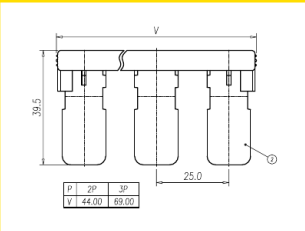

CSC-2-5XXPN



Use with DS20

Poles (XX) 02, 03, 04, 10

Dimensions - mm

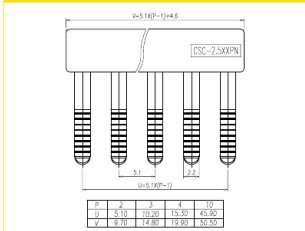

Side Insertion Bridges

CSC-6XXPN



Use with DS50

Poles (XX) 02, 03, 04, 10

Dimensions - mm

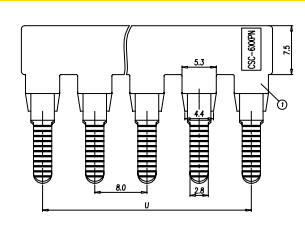

DS-204



Use with P25G
2P25G

Poles 02

Dimensions - mm

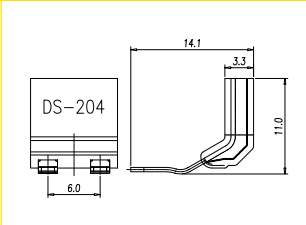

CSC-2.5XXPS

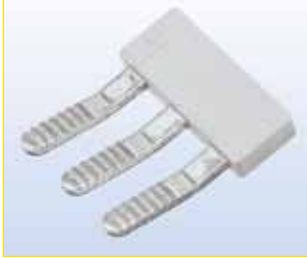

Use with DM20
P20S

Poles (XX) 02, 03, 04, 10

Dimensions - mm

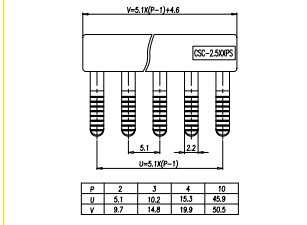

CSC-4XXPS



Use with DM30
P30S

Poles (XX) 02, 03, 04, 10

Dimensions - mm

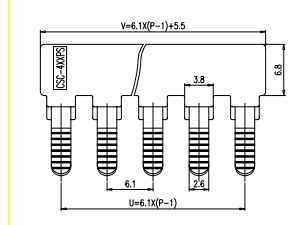

CSC-6XXPS



Use with DM50
P65S

Poles (XX) 02, 03, 04, 10

Dimensions - mm

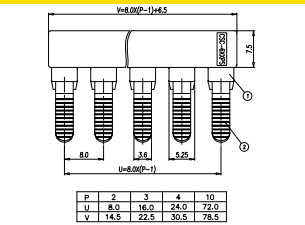

Accessories

Mounting Rails and Brackets

DRL15MM*
(15mm DIN-Rail)



DRL32MMG*
(32mm G-Type)



DRL35MMLO*
(35mm DIN-Rail - Low Profile)



DRL35MMHI*
(35mm DIN-Rail - High Profile)



NFTA Series**
(C-Rail)



NRA Series**
(C-Rail)



BRKT-ANGL
(Angle Bracket)



BRKT-FLT
(Flat Bracket)



*Available in 1 meter lengths only.

**Cut to length. Consult Cooper Bussmann for details.



BussScribe

MARKING SYSTEM

BussScribe Marking System

DPLT-001SET PLOTTER SET



DPLT-SPLT SUPPORT PLATE



PLOTTER PENS

DPLT-PEN (Tip 0.25mm)
DPLT-PEN2 (Tip 0.35mm)



Description

- Pen is installed manually
- USB interface to PC
- 110-240Vac power supply
- WINDOWS® Operation System

System Kit Includes:

- Plotter Pens
- Support Plate
- Software
- Plotter
- Power Supplies
- USB Cable

Description

Support plate adjustable to accommodate various sizes of marking labels. The support plate is universal and suitable for TM2xCB marking label series.

Each plotter set includes one support plate, additional plates are available separately.

Description

Disposable black ink cartridge pen.
Single pen per pack.

Marking Label Selection Chart

Part Number	Length (mm)	Width (mm)	Line x Row	Number of Tags	Applicable Block Part Numbers
TM20CB	5.8	5.1	20 x 10	200	F20TOP, DM20, P20S, P25G, 2P25G
TM21CB	5.8	6.1	20 x 10	200	DDP30, DM30, P30S
TM22CB	5.8	8.0	20 x 8	160	DM50, P65S
TM26CB	12	5.1	12 x 12	144	DS20, DP25, DG25, DDNS10, DIS10
TM27CB	12	6.1	12 x 10	120	DS30, DP35, DG35
TM28CB	12	8.0	12 x 7	84	DS50, DP45, DP60, DP100, DP150, DP230, DG60, DG100, DG150, DG230, F520ST, F520STLED, F520DDST, DTST2

Marking Label Ordering Method (typical)

Example: TM20CB–DH01, Horizontal Marking – L1, L2, L3, N, PE

TM20CB Series - mm

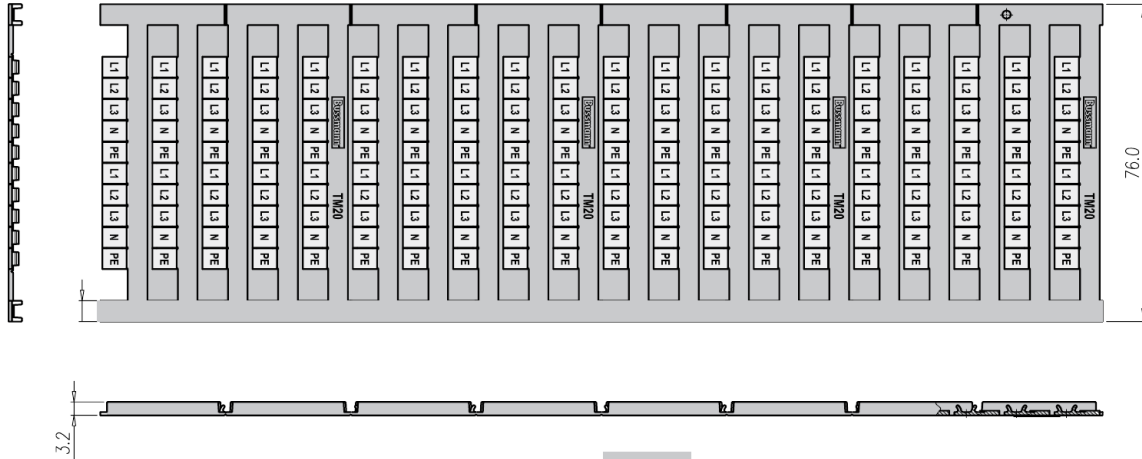

TM20CB

Part Numbers	Descriptions
TM20CB	Marking label, blank
TM20CB-DH01	Marking label, horizontal, (L1,L2,L3,N,PE) repeated 40 times
TM20CB-DH02	Marking label, horizontal, (L1,L2,L3,N) repeated 40 times
TM20CB-FH01	Marking label, horizontal, 1 to 10, repeated in 20 lines
TM20CB-FH0	Marking label, horizontal, 11 to 20, repeated in 20 lines
TM20CB-FH03	Marking label, horizontal, 21 to 30, repeated in 20 lines
TM20CB-FH04	Marking label, horizontal, 31 to 40, repeated in 20 lines
TM20CB-FH05	Marking label, horizontal, 41 to 50, repeated in 20 lines
TM20CB-EH01	Marking label, horizontal, 1 to 50, repeated in 4 sets
TM20CB-EH02	Marking label, horizontal, 51 to 100, repeated in 4 sets
TM20CB-DV01	Marking label, vertical, (L1,L2,L3,N,PE) repeated 40 times
TM20CB-DV02	Marking label, vertical, (L1,L2,L3,N) repeated 40 times
TM20CB-FV01	Marking label, vertical, 1 to 10, repeated in 20 lines
TM20CB-FV02	Marking label, vertical, 11 to 20, repeated in 20 lines
TM20CB-EV01	Marking label, vertical, 1 to 50, repeated in 4 sets

TM21CB

Part Numbers	Descriptions
TM21CB	Marking label, blank
TM21CB-DH01	Marking label, horizontal, (L1,L2,L3,N,PE) repeated 40 times
TM21CB-DH02	Marking label, horizontal, (L1,L2,L3,N) repeated 40 times
TM21CB-FH01	Marking label, horizontal, 1 to 10, repeated in 20 lines
TM21CB-FH02	Marking label, horizontal, 11 to 20, repeated in 20 lines
TM21CB-FH03	Marking label, horizontal, 21 to 30, repeated in 20 lines
TM21CB-FH04	Marking label, horizontal, 31 to 40, repeated in 20 lines
TM21CB-FH05	Marking label, horizontal, 41 to 50, repeated in 20 lines
TM21CB-EH01	Marking label, horizontal, 1 to 50, repeated in 4 sets
TM21CB-EH02	Marking label, horizontal, 51 to 100, repeated in 4 sets
TM21CB-DV01	Marking label, vertical, (L1,L2,L3,N,PE) repeated 40 times
TM21CB-DV02	Marking label, vertical, (L1,L2,L3,N) repeated 40 times
TM21CB-FV01	Marking label, vertical, 1 to 10, repeated in 20 lines
TM21CB-FV02	Marking label, vertical, 11 to 20, repeated in 20 lines
TM21CB-EV01	Marking label, vertical, 1 to 50, repeated in 4 sets

TM21CB Series - mm

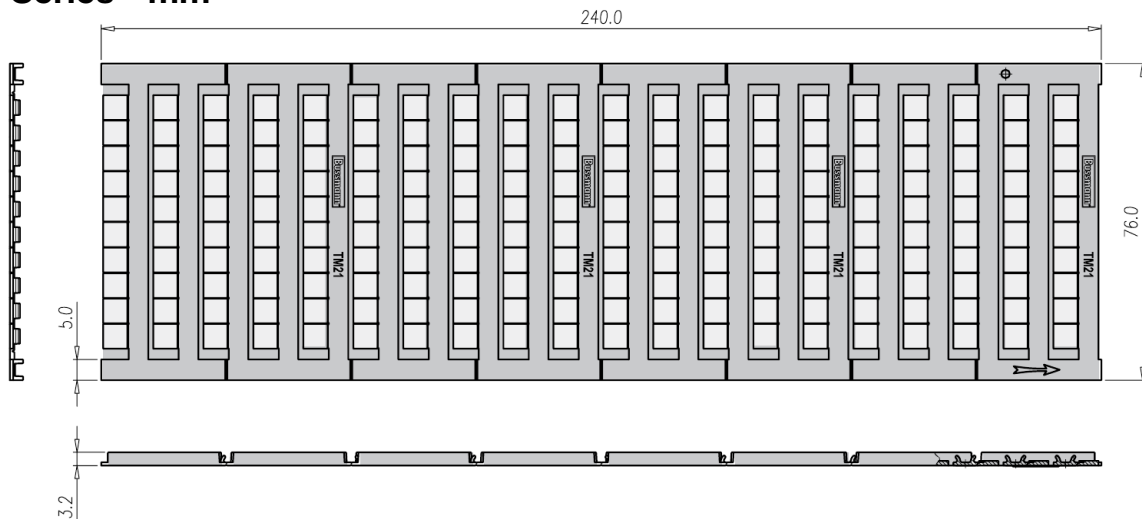

Marking Label Ordering Method (typical)

TM22CB Series - mm

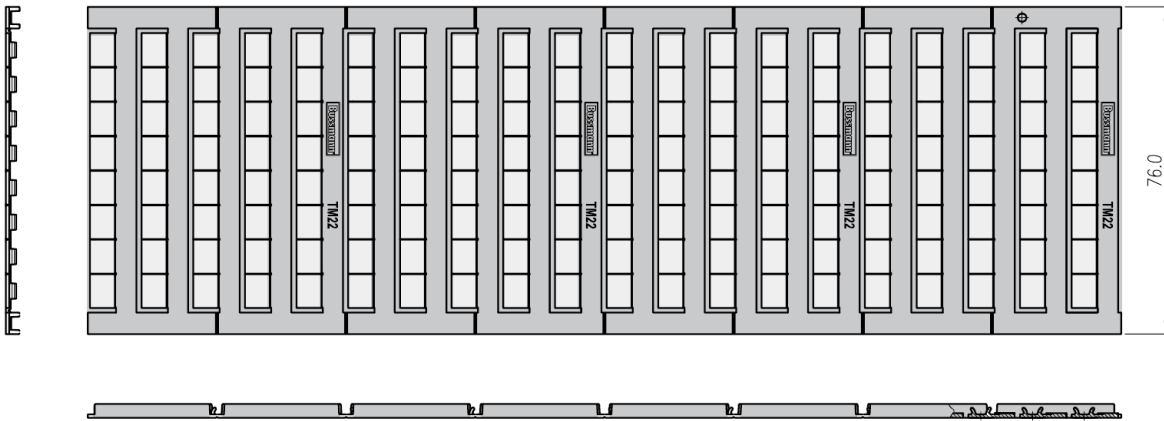

TM22CB

Part Numbers	Descriptions
TM22CB	Marking label, blank
TM22CB-DH01	Marking label, horizontal, (L1,L2,L3,N,PE) repeated 30 times
TM22CB-DH02	Marking label, horizontal, (L1,L2,L3,N) repeated 40 times
TM22CB-FH01	Marking label, horizontal, 1 to 10, repeated in 16 lines
TM22CB-FH02	Marking label, horizontal, 11 to 20, repeated in 16 lines
TM22CB-FH03	Marking label, horizontal, 21 to 30, repeated in 16 lines
TM22CB-FH04	Marking label, horizontal, 31 to 40, repeated in 16 lines
TM22CB-FH05	Marking label, horizontal, 41 to 50, repeated in 16 lines
TM22CB-EH01	Marking label, horizontal, 1 to 50, repeated in 3 sets
TM22CB-EH02	Marking label, horizontal, 51 to 100, repeated in 3 sets
TM22CB-DV01	Marking label, vertical, (L1,L2,L3,N,PE) repeated 30 times
TM22CB-DV02	Marking label, vertical, (L1,L2,L3,N) repeated 40 times
TM22CB-FV01	Marking label, vertical, 1 to 10, repeated in 16 lines
TM22CB-FV02	Marking label, vertical, 11 to 20, repeated in 16 lines
TM22CB-EV01	Marking label, vertical, 1 to 50, repeated in 3 sets

TM26CB

Part Numbers	Descriptions
TM26CB	Marking label, blank
TM26CB-DH01	Marking label, horizontal, (L1,L2,L3,N,PE) repeated 24 times
TM26CB-DH02	Marking label, horizontal, (L1,L2,L3,N) repeated 36 times
TM26CB-FH01	Marking label, horizontal, 1 to 10, repeated in 12 lines
TM26CB-FH02	Marking label, horizontal, 11 to 20, repeated in 12 lines
TM26CB-FH03	Marking label, horizontal, 21 to 30, repeated in 12 lines
TM26CB-FH04	Marking label, horizontal, 31 to 40, repeated in 12 lines
TM26CB-FH05	Marking label, horizontal, 41 to 50, repeated in 12 lines
TM26CB-EH01	Marking label, horizontal, 1 to 50, repeated in 2 sets
TM26CB-EH02	Marking label, horizontal, 51 to 100, repeated in 2 sets
TM26CB-DV01	Marking label, vertical, (L1,L2,L3,N,PE) repeated 24 times
TM26CB-DV02	Marking label, vertical, (L1,L2,L3,N) repeated 36 times
TM26CB-FV01	Marking label, vertical, 1 to 10, repeated in 12 lines
TM26CB-FV02	Marking label, vertical, 11 to 20, repeated in 12 lines
TM26CB-EV01	Marking label, vertical, 1 to 50, repeated in 2 sets

TM26CB Series - mm

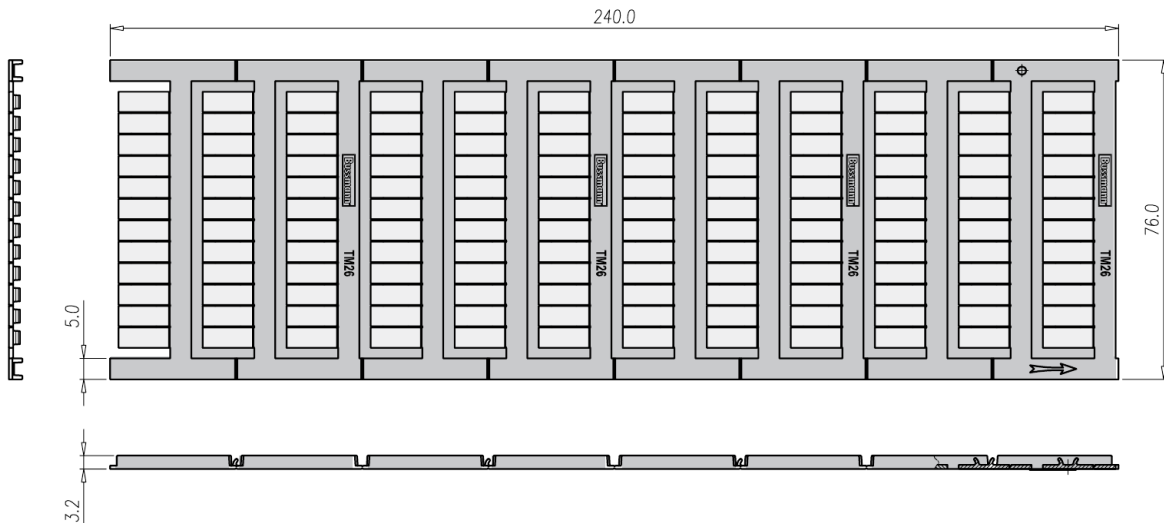

TM27CB Series - mm

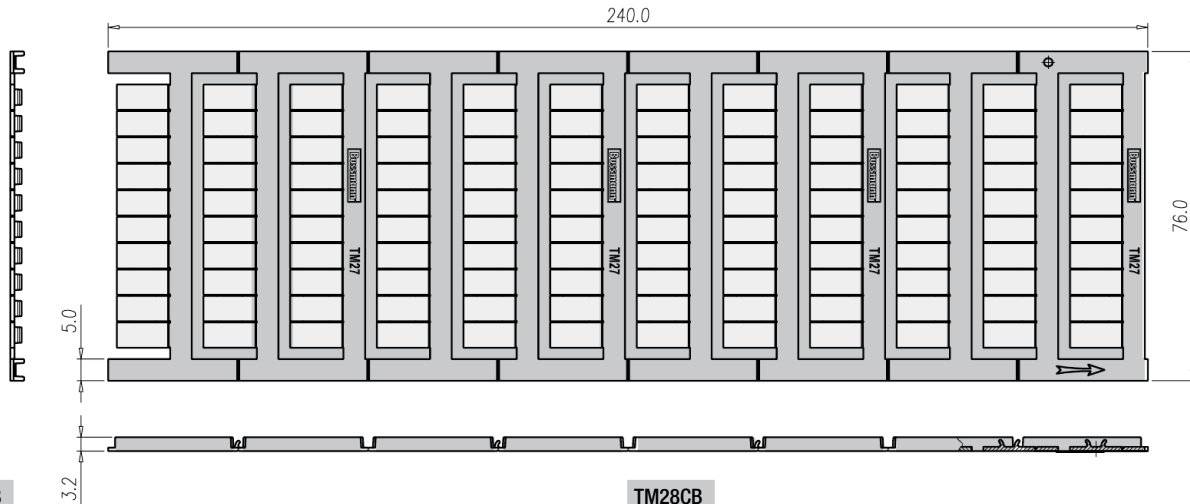

TM27CB

Part Numbers	Descriptions
TM27CB	Marking label, blank
TM27CB-DH01	Marking label, horizontal, (L1,L2,L3,N,PE) repeated 40 times
TM27CB-DH02	Marking label, horizontal, (L1,L2,L3,N) repeated 24 times
TM27CB-FH01	Marking label, horizontal, 1 to 10, repeated in 12 lines
TM27CB-FH02	Marking label, horizontal, 11 to 20, repeated in 12 lines
TM27CB-FH03	Marking label, horizontal, 21 to 30, repeated in 12 lines
TM27CB-FH04	Marking label, horizontal, 31 to 40, repeated in 12 lines
TM27CB-FH05	Marking label, horizontal, 41 to 50, repeated in 12 lines
TM27CB-EH01	Marking label, horizontal, 1 to 50, repeated in 2 sets
TM27CB-EH02	Marking label, horizontal, 1 to 50, repeated in 2 sets
TM27CB-DV01	Marking label, vertical, (L1,L2,L3,N,PE) repeated 24 times
TM27CB-DV02	Marking label, vertical, (L1,L2,L3,N) repeated 24 times
TM27CB-FV01	Marking label, vertical, 1 to 10, repeated in 12 lines
TM27CB-FV02	Marking label, vertical, 11 to 20, repeated in 12 lines
TM27CB-EV01	Marking label, vertical, 1 to 50, repeated in 2 sets

TM28CB

Part Numbers	Descriptions
TM28CB	Marking label, blank
TM28CB-DH01	Marking label, horizontal, (L1,L2,L3,N,PE) repeated 12 times
TM28CB-DH02	Marking label, horizontal, (L1,L2,L3,N) repeated 20 times
TM28CB-FH01	Marking label, horizontal, 1 to 10, repeated in 8 lines
TM28CB-FH02	Marking label, horizontal, 11 to 20, repeated in 8 lines
TM28CB-FH03	Marking label, horizontal, 21 to 30, repeated in 8 lines
TM28CB-FH04	Marking label, horizontal, 31 to 40, repeated in 8 lines
TM28CB-FH05	Marking label, horizontal, 41 to 50, repeated in 8 lines
TM28CB-EH01	Marking label, horizontal, 1 to 50, repeated in 1 sets
TM28CB-EH02	Marking label, horizontal, 51 to 100, repeated in 1 sets
TM28CB-DV01	Marking label, vertical, (L1,L2,L3,N,PE) repeated 12 times
TM28CB-DV02	Marking label, vertical, (L1,L2,L3,N) repeated 20 times
TM28CB-FV01	Marking label, vertical, 1 to 10, repeated in 8 lines
TM28CB-FV02	Marking label, vertical, 11 to 20, repeated in 8 lines
TM28CB-EV01	Marking label, vertical, 1 to 50, repeated in 1 sets

TM28CB Series - mm

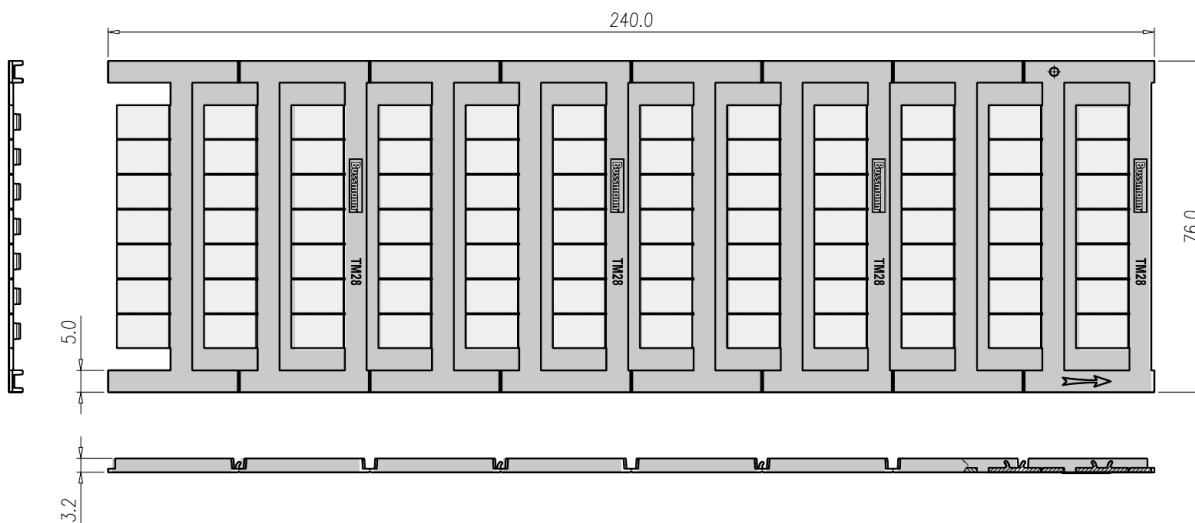

Index by Part Number

Catalog Number	Page	Catalog Number	Page	Catalog Number	Page	Catalog Number	Page	Catalog Number	Page
15188	26	CHM1DU	16	CSC-404PS	10, 20	DM30-LK	10	DPLT-PEN	40
15288	26	CHM2DIU	16	CSC-410P	8, 11	DM30-LK-ND	10	DPLT-PEN2	40
15188-_R	26	CHM2DU	16	CSC-410PN	7	DM50-BU	10	DPLT-SPLT	40
15188-_RS	26	CHM3DIU	16	CSC-410PS	10, 20	DM50-BU-ND	10	DRL15MM	10, 24, 38
15188-_S	26	CHM3DNIU	16	CSC-602P	8, 19	DM50	10	DRL32MMG	7-9, 11-15, 19, 38
15188-3	26	CHM3DNU	16	CSC-602PN	7, 14	DM50-GY-ND	10	DRL35MMHI	7-9, 11-16, 19, 22, 23, 26, 34, 38
15188-4	26	CHM3DU	16	CSC-602PS	10, 20	DM50-LK	10	DRL35MML	22, 23
15188J-2-J	26	CHM4DIU	16	CSC-603P	8, 19	DM50-LK-ND	10	DRL35MMLLO	7-9, 11-16, 19, 26, 34, 38
15288-R	26	CHM4DU	16	CSC-603PN	7, 14	DP100	9, 30, 33, 34, 36, 40		
15288-S	26	CHPV	16	CSC-603PS	10, 20	DP100-GY	9		
15288-ST	26	CHPV1IU	16	CSC-604P	8, 19	DP100-GY-ND	9	DS-204	21, 37
2P25G	21	CHPV2IU	16	CSC-604PN	7, 14	DP150	9, 30, 33, 34, 36, 40	DS10-02P	9
AT512	24	CHPV2U	16	CSC-604PS	10, 20	DP150-BU	9	DS10-03P	9
BB1P100M12	17	CHPVIU	16	CSC-610P	8, 19	DP150-GY	9	DS10-04P	9
BB1P100M15	17	CSC-1002P	9	CSC-610PN	7, 14	DP230	9, 30, 33, 40	DS10-10P	9
BB1P100M3	17	CSC-1003P	9	CSC-610PS	10, 20	DP230-BU	9	DS16-02P	9
BB1P100M57	17	CSC-1004P	9	CSC-9502P	9	DP230-GY	9	DS16-03P	9
BB1P100M6	17	CSC-1010P	9	CSC-9503P	9	DP25	8, 30, 33, 34, 36	DS16-04P	9
BB1P100M9	17	CSC-1602P	9	DDNS10	19	DP25-BU	8	DS16-10P	9
BB3P100M12	17	CSC-1603P	9	DDNS10-GY-ND	19	DP25-BU-ND	8	DS2-5-02P	8, 19
BB3P100M15	17	CSC-1604P	9	DDP30	11	DP25-GN	8	DS2-5-03P	8, 19
BB3P100M57	17	CSC-1610P	9	DDP30-GY-ND	11	DP25-GN-ND	8	DS2-5-04P	8, 19
BB3P100M6	17	CSC-2-502P	8, 11, 19	DG100	13, 30, 40	DP25-GY	8	DS2-5-10P	8, 19
BB3P100M9	17	CSC-2-502PN	7	DG100-YG	13	DP25-GY-ND	8, 9, 11	DS20	7, 34, 35, 36, 40
BNQ21	29	CSC-2-502PS	10, 20	DG150	13, 30, 40	DP25-LK	8	DS20-BU	7
BNQ21-WH	29	CSC-2-503P	8, 11, 19, 20	DG150-YG	13	DP25-LK-ND	8	DS20-BU-ND	7
BQE	29	CSC-2-503PN	7	DG230	13, 31, 40	DP25-OR	8	DS20-GN	7
BQQ41	29	CSC-2-503PS	10, 20	DG230-YG	13	DP25-OR-ND	8	DS20-GN-ND	7
BQQ41-WH	29	CSC-2-504P	8, 11, 19	DG25	12, 30, 33, 40	DP25-RD	8	DS20-GY	7
BRKT-ANGL	38	CSC-2-504PN	7	DG25-YG	12	DP25-RD-ND	8	DS20-GY-ND	7
BRKT-FLT	38	CSC-2-504PS	20	DG35	12, 30, 40	DP25-YW	8	DS20-LK	7
BRKT-ND	34	CSC-2-510P	8, 11, 19	DG35-YG	12	DP25-YW-ND	8	DS20-LK-ND	7
BRKT-NDSCRW	34	CSC-2-510PN	7	DG60	12, 30, 40	DP35	8, 30, 33, 34, 36, 40	DS20-OR	7
BRKT-NDSCRW2	34	CSC-2-510PS	10, 20	DG60-YG	12	DP35-BU	8	DS20-OR-ND	7
BRKT-NDSCRW3	34	CSC-2-502PS	10, 20	DIS10	11	DP35-GN	8	DS20-RD	7
C002-0101-BK	19	CSC-2-503PS	10, 20	DKNSPS-001	7, 34	DP35-GY	8	DS20-RD-ND	7
C002-0101-RD	19	CSC-2-504PS	10, 20	DKNSPS-002	7, 34	DP35-LK	8	DS20-YW	7
C002-0201	19	CSC-2-510PS	10, 20	DKNSPS-003	9, 34	DP35-OR	8	DS20-YW-ND	7
C002-0301	19	CSC-303P	8	DKNSPS-004	9, 34	DP35-RD	8	DS30	7, 34, 35, 36, 40
C003-0201	19	CSC-303PS	10	DKSPS-001	8, 9, 34	DP35-YW	8	DS30-BU	7
CHCC	16	CSC-3502P	9	DKSPS-002	8, 9, 11, 34	DP45	30, 33, 34, 36, 40	DS30-BU-ND	7
CHCC1DI-48U	16	CSC-3503P	9	DKSPS-006	19, 34	DP45-BU	8	DS30-GN	7
CHCC1DIU	16	CSC-3504P	9	DM20-BU	10	DP45-GN	8	DS30-GN-ND	7
CHCC2DIU	16	CSC-3510P	9	DM20-BU-ND	10	DP45-GY	8	DS30-GY	7
CHCC3DIU	16	CSC-402P	8, 10, 11	DM20	10	DP45-LK	8	DS30-GY-ND	7
CHCC3DU	16	CSC-402PN	7	DM20-GY-ND	10	DP45-OR	8	DS30-LK	7
CHM	16	CSC-402PS	10, 20	DM20-LK	10	DP45-RD	8	DS30-LK-ND	7
CHM1DI-48U	16	CSC-403P	11	DM20-LK-ND	10	DP45-YW	8	DS30-OR	7
CHM1DIU	16	CSC-403PN	7	DM30-BU	10	DP60	9, 30, 33, 40, 36, 40	DS30-OR-ND	7
CHM1DNIU	16	CSC-403PS	20	DM30-BU-ND	10	DP60-GY	9	DS30-RD	7
CHM1DNU	16	CSC-404P	8, 11	DM30	10	DPLT-001	40	DS30-RD-ND	7
CHM1DNXU	16	CSC-404PN	7	DM30-GY-ND	10	DPLT-001SW	40	DS30-YW	7

Call Cooper Bussmann Customer Satisfaction for more information. Call 636.527.3877

Index by Part Number

Catalog Number	Page	Catalog Number	Page	Catalog Number	Page	Catalog Number	Page	Catalog Number	Page
DS30-YW-ND	7	F520DDST	14	NDN3-WH	22	PSU111-WH	27	TM26CB-DH02	42
DS35-02P	9	F520ST	14	NDN3-YE	22	PWR1PLP	17, 18	TM26CB-DV01	42
DS35-03P	9	F520STLED	14	NDN63	22	PWR35MM	17, 18	TM26CB-DV02	42
DS35-04P	9	F520STLED110-GY	14	NDN63-BK	22	PWR50MM	17, 18	TM26CB-EH01	42
DS35-10P	9	F520STLED12-GY	14	NDN63-WH	22	TM20CB	41	TM26CB-EH02	42
DS4-02P	8, 11	F520STLED220-GY	14	NDN63-YE	22	TM20CB-DH01	41	TM26CB-EV01	42
DS4-03P	8, 11	F520STLED24-GY	14	NDNV4	22	TM20CB-DH02	41	TM26CB-FH01	42
DS4-04P	8, 11	F520STLED300-GY	14	NDNV4-BK	22	TM20CB-DV01	41	TM26CB-FH02	42
DS4-10P	8, 11	F520STLED48-GY	14	NDNV4-WH	22	TM20CB-DV02	41	TM26CB-FH03	42
DS50	34, 37, 40	F520STLED5-GY	14	NDNV4-YE	22	TM20CB-EH01	41	TM26CB-FH04	42
DS50-BU	7	F520TOP	15	NFT2	24	TM20CB-EH02	41	TM26CB-FH05	42
DS50-BU-ND	7	F520TOP-GY	15	NFT2-BK	24	TM20CB-EV01	41	TM26CB-FV01	42
DS50-GN	7	FSCVR	17, 18	NFT2-BL	24	TM20CB-FH0	41	TM26CB-FV02	42
DS50-GN-ND	7	JN1	23, 27	NFT2-RE	24	TM20CB-FH01	41	TM27CB	43
DS50-GY	7	JN2	24	NFT3-WH	24	TM20CB-FH02	41	TM27CB-DH01	43
DS50-GY-ND	7	JN3	22, 28	NFT3	24	TM20CB-FH03	41	TM27CB-DH02	43
DS50-LK	7	JN4	22, 28	NFT3-BK	24	TM20CB-FH04	41	TM27CB-DV01	43
DS50-LK-ND	7	JN512	24	NFT3-BL	24	TM20CB-FH05	41	TM27CB-DV02	43
DS50-OR	7	JNDN3	22	NFT3-RE	24	TM20CB-FV01	41	TM27CB-EH01	43
DS50-OR-ND	7	JNSE3	25	NFT3-WH	24	TM20CB-FV02	41	TM27CB-EH02	43
DS50-RD	7	JNSS3	25	NFT3-YE	24	TM21CB	41	TM27CB-EV01	43
DS50-RD-ND	7	KAD	28	NFTA Series	22-27, 29, 38	TM21CB-DH01	41	TM27CB-FH01	43
DS50-YW	7	KT3	28	NRA Series	22-27, 29, 38	TM21CB-DH02	41	TM27CB-FH02	43
DS50-YW-ND	7	KT3-BK	28	NSE3	25	TM21CB-DV01	41	TM27CB-FH03	43
DS6-02P	8	KT3-RE	28	NSE3-WH	25	TM21CB-DV02	41	TM27CB-FH04	43
DS6-03P	8, 19	KT3-WH	28	NSS3	25	TM21CB-EH01	41	TM27CB-FH05	43
DS6-04P	8, 19	KT4	28	NSS3-BK	25	TM21CB-EH02	41	TM27CB-FV01	43
DS6-10P	8, 19	KT4-BK	28	NSS3-WH	25	TM21CB-EV01	41	TM27CB-FV02	43
DS6A02	19, 35	KT4-WH	28	NTQ23	29	TM21CB-FH01	41	TM28CB	43
DS6A03	19, 35	MT12-1-2	22-29	NTQ23-WH	29	TM21CB-FH02	41	TM28CB-DH01	43
DS6S1-BK	19	MTC6	22, 28	P20S	20	TM21CB-FH03	41	TM28CB-DH02	43
DS6S1-OR	19	N512	24	P20S-GY-ND	20	TM21CB-FH04	41	TM28CB-DV01	43
DS6S1-RD	19	N512-BK	24	P25G	21	TM21CB-FH05	41	TM28CB-DV02	43
DS6S1-YW	19	NC3	25	P25G-GY-ND	21	TM21CB-FV01	41	TM28CB-EH01	43
DSS2-5N-02P	7	NC3-BK	25	P30S	20	TM21CB-FV02	41	TM28CB-EH02	43
DSS2-5N-03P	7	NC3-WH	25	P30S-GY-ND	20	TM22CB	42	TM28CB-EV01	43
DSS2-5N-04P	7	NDN1	22, 23	P65S	20	TM22CB-DH01	42	TM28CB-FH01	43
DSS2-5N-04P	7	NDN1-WH	23	P65S-GY-ND	20	TM22CB-DH02	42	TM28CB-FH02	43
DSS2-5N-10P	7	NDN111	23	PLK3	28	TM22CB-DV01	42	TM28CB-FH03	43
DSS4N-02P	7	NDN111-BK	23	PLK3-WH	28	TM22CB-DV02	42	TM28CB-FH04	43
DSS4N-03P	7	NDN111-BL	23	PLOTTER PENS	40	TM22CB-EH01	42	TM28CB-FH05	43
DSS4N-04P	7	NDN111-RE	23	PLU1	27	TM22CB-EH02	42	TM28CB-FV01	43
DSS4N-10P	7	NDN111-WH	23	PLU1-WH	27	TM22CB-EV01	42	TM28CB-FV02	43
DSS6N-02P	7	NDN111-YE	23	PLU11-WH	27	TM22CB-FH01	42		
DSS6N-03P	7	NDN111A-BK	23	PLU111-WH	27	TM22CB-FH02	42		
DSS6N-04P	7	NDN111A-WH	23	PLU3	26	TM22CB-FH03	42		
DSS6N-10P	7	NDN111A-YE	23	PLU3-BK	26	TM22CB-FH04	42		
DTST-GY-ND	19	NDN1A-WH	23	PLU3-WH	26	TM22CB-FH05	42		
DTST2	19	NDN3	22	PLU3-YE	26	TM22CB-FV01	42		
ECAP1P	17, 18	NDN3-BK	22	PSU1	27	TM22CB-FV02	42		
F520-GY-ND	14	NDN3-BL	22	PSU1-WH	27	TM26CB	42		
F520DD-GY-ND	14	NDN3-RE	22	PSU11-WH	27	TM26CB-DH01	42		

Call Cooper Bussmann Customer Satisfaction for more information. Call 636.527.3877

Everything for Your DIN-Rail – from Cooper Bussmann

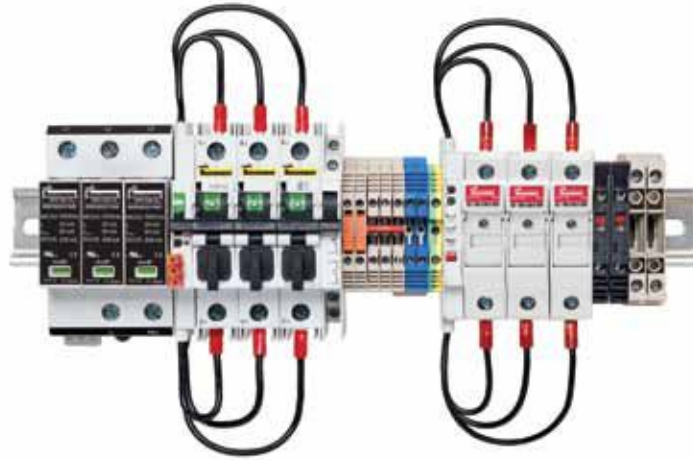

DIN-Rail Terminal Blocks

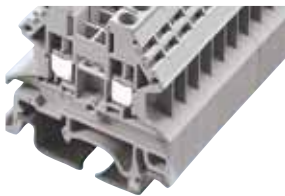

Full range of single and two-level terminal blocks, test and knife disconnect blocks, plug-in and screw-on bridges, and marking system for control cabinet wiring.

Low Profile Barrier Strips



Space saving low to high current barrier strips from the leader in the industry. We also customize.

Panel Mount Terminal Blocks

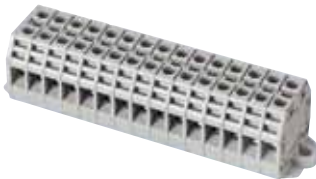

Flexible alternative to barrier strips with screw and spring-cage wiring connections for feed through and one-to-two power distribution.

Surge Protective Devices (SPDs)



Full range of SPDs for Solar, IEC, Wind, Low Voltage Power and Control, and UL AC/DC applications. Industry's only true, UL 1449 3rd Edition compliant overvoltage protectors.

Modular Fuse Holders



Modular fuse holders for Class CC, 10x38 and Class J fuses with remote PLC indication.

Compact Circuit Protector (CCP)



At 1/3 the space required by a molded case circuit breaker, the CCP saves space in your panel. High SCCR DIN-Rail mounted electrical disconnect.

Power Distribution Blocks



UL Listed, finger-safe enclosed power distribution blocks offer high SCCR. Includes splicer blocks to one-to-21 load distribution options per pole.

Customer Assistance

Customer Satisfaction Team

Available to answer questions regarding Cooper Bussmann products & services Monday-Friday, 8:00 a.m. – 4:30 p.m. for all US time zones.

Contact:

- Toll-free phone: 855-287-7626 (855-BUSSMANN)
- Toll-free fax: 800-544-2570
- E-mail: busscustsat@cooperindustries.com

Emergency and After-Hours Orders

Next flight out or will call shipment for time-critical needs. Customers pay only standard product price, rush freight charges, & modest emergency service fee. Place these orders through the Customer Satisfaction Team during regular business hours. For after-hours, contact:

- Phone: 314-995-1342

C³ – the Enhanced, Online Cooper Customer Center

Provides real time product availability, net pricing, order status & shipment tracking across six Cooper divisions: B-line, Bussmann, Crouse-Hinds, Lighting, Power Systems & Wiring Devices. Available at:

- www.cooperc3.com
- 877-995-5955 for log-in assistance

Application Engineering

Technical assistance is available to all customers. Staffed by degreed engineers, this application support is available Monday-Friday, 8:00 a.m. – 5:00 p.m. CT

Contact:

- Phone: 636-527-1270
- Fax: 636-527-1607
- E-mail: fusetech@cooperindustries.com

Online Resources

Visit www.cooperbussmann.com for the following resources:

- Product search & cross-reference
- Product & technical materials
- Solutions centers for information on topical issues including arc-flash, selective coordination & short-circuit current rating
- Technical tools, like our arc-flash calculator
- Where to purchase Cooper Bussmann product

Cooper Bussmann
St. Louis, MO 63178
855.287.7626 (855-BUSSMANN)
www.cooperbussmann.com

Your Authorized Cooper Bussmann Distributor is:



©2012 Cooper Bussmann
www.cooperbussmann.com

Компания «Life Electronics» занимается поставками электронных компонентов импортного и отечественного производства от производителей и со складов крупных дистрибьюторов Европы, Америки и Азии.

С конца 2013 года компания активно расширяет линейку поставок компонентов по направлению коаксиальный кабель, кварцевые генераторы и конденсаторы (керамические, пленочные, электролитические), за счёт заключения дистрибьюторских договоров

Мы предлагаем:

- Конкурентоспособные цены и скидки постоянным клиентам.
- Специальные условия для постоянных клиентов.
- Подбор аналогов.
- Поставку компонентов в любых объемах, удовлетворяющих вашим потребностям.
- Приемлемые сроки поставки, возможна ускоренная поставка.
- Доставку товара в любую точку России и стран СНГ.
- Комплексную поставку.
- Работу по проектам и поставку образцов.
- Формирование склада под заказчика.
- Сертификаты соответствия на поставляемую продукцию (по желанию клиента).
- Тестирование поставляемой продукции.
- Поставку компонентов, требующих военную и космическую приемку.
- Входной контроль качества.
- Наличие сертификата ISO.

В составе нашей компании организован Конструкторский отдел, призванный помогать разработчикам, и инженерам.

Конструкторский отдел помогает осуществить:

- Регистрацию проекта у производителя компонентов.
- Техническую поддержку проекта.
- Защиту от снятия компонента с производства.
- Оценку стоимости проекта по компонентам.
- Изготовление тестовой платы монтаж и пусконаладочные работы.



Тел: +7 (812) 336 43 04 (многоканальный)

Email: org@lifeelectronics.ru