

## Round Water-resistive Smartclick Connectors That Reduce Installation Work

- A newly developed lock mechanism that is compatible with round M12 connectors.
- Simply insert the Connectors, then turn them approximately 1/8 of a turn to lock.
- A positive click indicates locking.
- Features the same degree of protection (IP67) as M12 connectors.
- Connectors with Cables are UL certified.
- Four types of assembly methods are available, including IDC, crimping, soldering and screw-on types.



Refer to *Safety Precautions* on page 27.



## Model Number Structure

### Connectors with Cables Model Number Legend

Connector	Cable specifications	XS5: One-touch Smartclick Connection (compatible with M12 connectors)			XS2: M12 Screw Connection*			
		Cable length (m)	Model	Reference page	Cable length (m)	Model		
Connectors on both cable ends	Fire-retardant, robot cable	0.5	XS5W-D421-B81-F	3	0.5	—		
		1	XS5W-D421-C81-F		1	XS2W-D421-C81-F		
		2	XS5W-D421-D81-F		2	XS2W-D421-D81-F		
		3	XS5W-D421-E81-F		3	XS2W-D421-E81-F		
		4	XS5W-D421-F81-F		4	—		
		5	XS5W-D421-G81-F		5	XS2W-D421-G81-F		
	Oil-resistant polyurethane robot cable	2	XS5W-D42B-D81-PR		2	—		
		5	XS5W-D42B-G81-PR		5	—		
		10	XS5W-D42B-J81-PR		10	—		
	Spatter-resistant Cable	2	XS5W-D421-D81-SA		2	XS2W-D421-D81-SA		
		5	XS5W-D421-G81-SA		5	XS2W-D421-G81-SA		
	Connector on one cable end (Socket)	Fire-retardant, robot cable	1		XS5F-D421-C80-F	6	1	XS2F-D421-C80-F
2			XS5F-D421-D80-F	2	XS2F-D421-D80-F			
3			XS5F-D421-E80-F	3	—			
5			XS5F-D421-G80-F	5	XS2F-D421-G80-F			
10			XS5F-D421-J80-F	10	XS2F-D421-J80-F			
2			XS5F-D42B-D80-PR	2	—			
Oil-resistant polyurethane robot cable		5	XS5F-D42B-G80-PR	5	—			
		10	XS5F-D42B-J80-PR	10	—			
		2	XS5F-D421-D80-SA	2	XS2F-D421-D80-SA			
Spatter-resistant Cable		5	XS5F-D421-G80-SA	5	XS2F-D421-G80-SA			
		Connector on one cable end (Plug)	Fire-retardant, robot cable	0.3	XS5H-D421-A80-F		8	0.3
0.5				XS5H-D421-B80-F	0.5			XS2H-D421-B80-F
1	XS5H-D421-C80-F			1	XS2H-D421-C80-F			
2	XS5H-D421-D80-F			2	XS2H-D421-D80-F			
3	XS5H-D421-E80-F			3	—			
5	XS5H-D421-G80-F			5	XS2H-D421-G80-F			
Spatter-resistant Cable	0.3	XS5H-D421-A80-SA	0.3	XS2H-D421-A80-SA				
	1	XS5H-D421-C80-SA	1	XS2H-D421-C80-SA				

\*For details, refer to the data sheet of the XS2 Round Water-resistant Connectors (M12 Threads).  
 Note 1. Only DC, straight, and 4-core types are shown in this table. Refer to the relevant pages for other products.  
 2. Other than the M12 sizes introduced in this table, M8-sized (XS3) products and M8-M12 conversion cables are also available.  
 For details, refer to the data sheet of the XS3 Round Water-resistant Connectors (M8/S8).

### XS5: One-touch Smartclick Connection (compatible with M12 screws)

Note: Screw connections will be made if connecting with a screw type.



### XS2: M12 Screw Connection\*



\*For details, refer to the data sheet of the XS2 Round Water-resistant Connectors (M12 Threads).

Features

Featuring a Lock Mechanism that Connects and Disconnects with One-touch

It can be used easily by anyone, significantly reducing man-hours spent on wiring.

Turn approx. 1/8 of a turn to connect

Align the protrusions on the cover and insert all the way



Connections can be checked visually using markings

Click! 1/8 of a turn

Connections are complete when an audible click sound can be heard.



Installation time



According to reference values obtained by OMRON.

It does not become loose due to machine vibration, meaning periodic re-tightening is unnecessary.

Featuring a bayonet locking mechanism



Enlarged view of bayonet locking mechanism

Compatibility with M12 Screws

Can also be connected to M12 screw sensors and actuators

	XS5 Smartclick Plug Connectors	M12 Screw Plug Connectors
XS5 Smartclick Socket Connectors	One-touch connection	Screw connection
M12 Screw Socket Connectors	Screw connection	Screw connection

All types of combinations can be connected. Screw connections will be made if connecting Smartclick with a screw type.

Ratings and Specifications

Rated current	4 A
Rated voltage	250 VDC
Contact resistance (connector)	40 mΩ max. (20 mV max., 100 mA max.)
Insulation resistance	1,000 MΩ min. (at 500 VDC)
Dielectric strength (connector)	1,500 VAC for 1 min (leakage current: 1 mA max.)
Degree of protection	IP67 (IEC60529)
Insertion tolerance	50 times
Lock strength	Tensile: 100 N/15 s, Torsion: 1 N·m/15 s
Cable holding strength	Tensile: 100 N/15 s, Torsion: 1 N·m/15 s (for cable diameter of 6 mm) *2
Lock operating force	0.1 to 0.25 N·m
Ambient operating temperature range	-25 to 70°C *3
Ambient humidity range	20% to 85%
Number of pressure-weld repairs *1	10 times max. (Limited to the same external diameter and wire diameter.)

\*1. Only XS5C/G (IDC models)

\*2. Refer to product specifications for details.

\*3. Use the robot cable within a temperature range between 0°C and 70°C to prevent the wires inside the cable from being broken when bending it.

## Materials and Finish

Item		Model	XS5F/H/W	XS5R	XS5M/P	XS5C/G (Crimping, Soldering)	XS5C/G (Screw-on)	XS5C/G (IDC)
Contacts	Material		Phosphor bronze	Phosphor bronze or Brass	Phosphor bronze	Brass	Phosphor bronze or Brass	Phosphor bronze
	Finish		Nickel base, 0.4- $\mu$ m gold plating					
Fixture			Nickel plated zinc alloy					
Fixtures (Lock) *			Stainless					
Pin block			PBT resin (UL94V-0)					
O-ring			Rubber					
Cover			Soft PBT resin (UL94V-0)		—	PBT resin (UL94V-0)		
Cable	Fire-retardant, robot cable		UL AWM2464 CL3, 6 mm dia., AWG20 (0.5 mm <sup>2</sup> ) Structure: 0.08 mm/110 wires			—		
	Oil-resistant polyurethane cable		6 mm dia. AWG20 (0.5 mm <sup>2</sup> ) Structure: 0.12mm/45 wires			—		
	Spatter-resistant Cable		6.6 mm dia. AWG20 (0.5 mm <sup>2</sup> ) Structure: 0.08 mm/100 wires			—		
	Oil-resistant polyurethane robot cable		4.7 mm dia. AWG23 (0.3 mm <sup>2</sup> ) Structure: 0.08 mm/60 wires			—		

\*Only plug

## Pin Arrangement (Engaged Side)

Item	No. of poles	4 poles
DC type	Male (plug) contacts	
	Female (socket) contacts	

## Connection Combinations

OMRON model No.		Smartclick Plug Connectors	M12 Plug Connectors
		XS5H, XS5G, XS5W (plug side), XS5R (plug side), XS5M	XS2H, XS2G, XS2W (plug side), XS2R (plug side), XS2M
Smartclick Socket Connectors	XS5F, XS5C, XS5W (socket side), XS5R (socket side), XS5P	⊙	○
M12 Socket Connectors	XS2F, XS2C, XS2W (socket side), XS2R (socket side), XS2P	○	○

⊙: Connected by twisting.

○: Connected by screwing.

Note: The XS□M and XS□P cannot mate with each other.

# XS5W

## Connectors with Cables, Socket and Plug on Both Cable Ends

### Model Number Legend

**XS5W-D42** **-** **81-**  

1
2
3
4
5
6
7
8
9

Use this model number legend to identify products from their model number.  
Use this model number legend to identify products from their model number. When ordering, use a model number from the table in *Ordering Information*.

#### 1. Type

W: Connectors with cables, socket and plug on both cable ends

#### 2. Mating Section Form

D: DC

#### 3. Connector Poles

4: 4 poles

#### 4. Contact Plating

2: 0.4- $\mu$ m gold plating

#### 5. Cable Connection Direction

- 1: Straight/straight
- 2: Right-angle/right-angle
- 3: Straight (Socket)/right-angle (Plug)
- 4: Right-angle (Socket)/straight (Plug)
- B: Straight/straight (4.7 dia.)

#### 6. Cable Length

A: 0.3 m    B: 0.5 m    C: 1 m    D: 2 m  
E: 3 m    F: 4 m    G: 5 m    J: 10 m

#### 7. Connections

8: ① Brown, ② White, ③ Blue, ④ Black (Numbers inside circles are terminal numbers)

#### 8. Connectors on One Cable End/Both Ends

1: Connectors on both cable ends

#### 9. Cable Specifications

F: Fire-retardant, robot cable  
P: Oil-resistant Polyurethane Cable  
SA: Spatter-resistant cable  
PR: Oil-resistant polyurethane robot cable

### Ordering Information

Cable specifications	Cable length L (m)	Cable diameter (mm)	Straight/straight	Right-angle/right-angle	UL
			Model	Model	
Fire-retardant, Robot Cable	0.5	6 dia.	XS5W-D421-B81-F	—	Yes
	1		XS5W-D421-C81-F	—	
	2		XS5W-D421-D81-F	XS5W-D422-D81-F	
	3		XS5W-D421-E81-F	—	
	4		XS5W-D421-F81-F	—	
	5		XS5W-D421-G81-F	XS5W-D422-G81-F	
	10		XS5W-D421-J81-F	—	
Oil-resistant polyurethane cable	2	6.6 dia.	XS5W-D421-D81-P	—	—
	5		XS5W-D421-G81-P	—	
	10		XS5W-D421-J81-P	—	
Spatter-resistant Cable	2	6.6 dia.	XS5W-D421-D81-SA	—	—
	5		XS5W-D421-G81-SA	—	
Oil-resistant polyurethane robot cable	2	4.7 dia.	XS5W-D42B-D81-PR	—	—
	5		XS5W-D42B-G81-PR	—	
	10		XS5W-D42B-J81-PR	—	
Cable specifications	Cable length L (m)	Cable diameter (mm)	Straight (Socket)/right-angle (Plug)	Right-angle (Socket)/straight (Plug)	UL
			Model	Model	
Fire-retardant, Robot Cable	2	6 dia.	XS5W-D423-D81-F	XS5W-D424-D81-F	Yes
	5		XS5W-D423-G81-F	XS5W-D424-G81-F	

Note: Ask your OMRON representative about other cable lengths.

## Dimensions

### Straight/straight

Fire-retardant, Robot Cable

XS5W-D421-□81-F

Oil-resistant Polyurethane Cable

XS5W-D421-□81-P

Spatter-resistant Cable

XS5W-D421-□81-SA

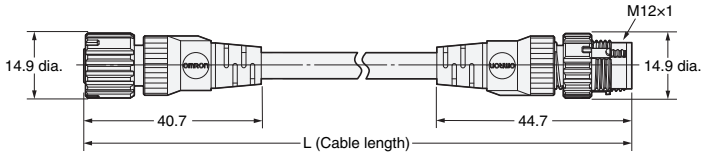

### Right-angle/right-angle

Fire-retardant, Robot Cable

XS5W-D422-□81-F

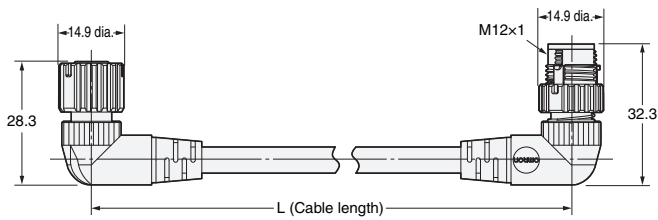

### Straight (Socket)/right-angle (Plug)

Fire-retardant, Robot Cable

XS5W-D423-□81-F

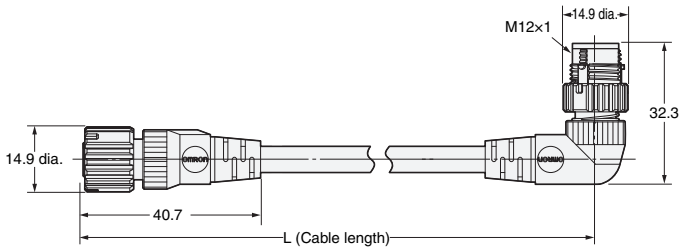

### Right-angle (Socket)/straight (Plug)

Fire-retardant, Robot Cable

XS5W-D424-□81-F

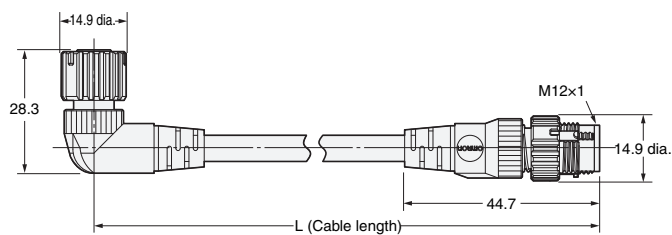

Note: Oil-resistant polyurethane cables (XS5W-D42□-□81-P) and spatter-resistant cables (XS5W-D421-□81-SA) have black covers.

Fire-retardant, robot cables (XS5W-D42□-□81-F), oil-resistant (polyurethane) robot cables (XS5W-D42B-□81-PR) have warm gray covers.

### Wiring Diagram for 4 Cores

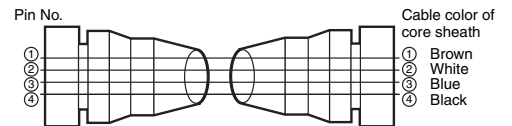

# XS5F Connectors with Cables, Socket on One Cable End

## Model Number Legend

**XS5F-D42**      **80-**

1    2 3 4 5    6 7 8    9

Use this model number legend to identify products from their model number.  
Use this model number legend to identify products from their model number. When ordering, use a model number from the table in *Ordering Information*.

### 1. Type

F: Connectors with cables  
Socket on one cable end

### 2. Mating Section Form

D: DC

### 3. Connector Poles

4: 4 poles

### 4. Contact Plating

2: 0.4- $\mu$ m gold plating

### 5. Cable Connection Direction

1: Straight  
2: Right-angle  
B: Straight (4.7 dia.)  
C: Right-angle (4.7 dia.)

### 6. Cable Length

A: 0.3 m    B: 0.5 m    C: 1 m  
D: 2 m    E: 3 m    G: 5 m  
H: 7 m    J: 10 m    L: 20 m

### 7. Connections

8: ① Brown, ② White, ③ Blue,  
④ Black (Numbers inside circles are terminal numbers)

A: ① Brown, ② -, ③ -, ④ Blue (DC)  
(Numbers inside circles are terminal numbers)

### 8. Connectors on One Cable End/ Both Ends

0: One cable end

### 9. Cable Specifications

F: Fire-retardant, robot cable  
P: Oil-resistant polyurethane cable  
SA: Spatter-resistant cable  
PR: Oil-resistant polyurethane robot cable

## Ordering Information

Cable specifications	Cable length L (m)	Cable diameter (mm)	Straight Connectors	Right-angle Connectors	UL
			Model	Model	
Fire-retardant, Robot Cable	1	6 dia.	XS5F-D421-C80-F	XS5F-D422-C80-F	Yes
	2		XS5F-D421-D80-F	XS5F-D422-D80-F	
	3		XS5F-D421-E80-F	XS5F-D422-E80-F	
	5		XS5F-D421-G80-F	XS5F-D422-G80-F	
	10		XS5F-D421-J80-F	XS5F-D422-J80-F	
Oil-resistant polyurethane cable	2	6.6 dia.	XS5F-D421-D80-P	XS5F-D422-D80-P	—
	5		XS5F-D421-G80-P	XS5F-D422-G80-P	
	10		XS5F-D421-J80-P	XS5F-D422-J80-P	
Spatter-resistant Cable	2	4.7 dia.	XS5F-D421-D80-SA	—	—
	5		XS5F-D421-G80-SA	—	
Oil-resistant polyurethane robot cable	2	4.7 dia.	XS5F-D42B-D80-PR	XS5F-D42C-D80-PR	—
	5		XS5F-D42B-G80-PR	XS5F-D42C-G80-PR	
	10		XS5F-D42B-J80-PR	XS5F-D42C-J80-PR	

Note: Ask your OMRON representative about other cable lengths, and about 2-core cables.

**Dimensions**

**Straight**

**Fire-retardant, Robot Cable**

**XS5F-D421-□80-F**

**Oil-resistant Polyurethane Cable**

**XS5F-D421-□80-P**

**Spatter-resistant Cable**

**XS5F-D421-□80-SA**

**Oil-resistant Polyurethane Robot Cable**

**XS5F-D42B-□80-PR**



**Wiring Diagram for 4 Cores**



**Right-angle**

**Fire-retardant, Robot Cable**

**XS5F-D422-□80-F**

**Oil-resistant Polyurethane Cable**

**XS5F-D422-□80-P**

**Oil-resistant Polyurethane Robot Cable**

**XS5F-D42C-□80-PR**



Note: Oil-resistant Polyurethane Cable(XS5F-D42□-□80-P),  
 Spatter-resistant cables (XS5F-D421-□80-SA) have black covers.  
 Fire-retardant, robot cables (XS5F-D42□-□80-F), oil-resistant (polyurethane) robot cables  
 (XS5F-D42□-□80-PR) have warm gray covers.

# XS5H

## Connectors with Cables, Plug on One Cable End

### Model Number Legend

XS5H-D42□-□80-□□

1
2
3
4
5
6
7
8
9

Use this model number legend to identify products from their model number.  
Use this model number legend to identify products from their model number. When ordering, use a model number from the table in *Ordering Information*.

#### 1. Type

H: Connectors with cables  
Plug on one cable end

#### 2. Mating Section Form

D: DC

#### 3. Connector Poles

4: 4 poles

#### 4. Contact Plating

2: 0.4- $\mu$ m gold plating

#### 5. Cable Connection Direction

1: Straight  
2: Right-angle

#### 6. Cable Length

A: 0.3 m    B: 0.5 m    C: 1 m  
D: 2 m    E: 3 m    G: 5 m

#### 7. Connections

8: ① Brown, ② White, ③ Blue,  
④ Black (Numbers inside circles  
are terminal numbers)

#### 8. Connectors on One Cable End/ Both Ends

0: One cable end

#### 9. Cable Specifications

F: Fire-retardant, robot cable  
P: Oil-resistant Polyurethane Cable  
SA: Spatter-resistant cable

### Ordering Information

Cable specifications	Cable length L (m)	Cable diameter (mm)	Straight Connectors	Right-angle Connectors	UL
			Model	Model	
Fire-retardant, Robot Cable	0.3	6 dia.	XS5H-D421-A80-F	XS5H-D422-A80-F	Yes
	0.5		XS5H-D421-B80-F	—	
	1		XS5H-D421-C80-F	XS5H-D422-C80-F	
	2		XS5H-D421-D80-F	XS5H-D422-D80-F	
	3		XS5H-D421-E80-F	—	
	5		XS5H-D421-G80-F	XS5H-D422-G80-F	
Oil-resistant polyurethane cable	0.3	6.6 dia.	XS5H-D421-A80-P	XS5H-D422-A80-P	—
	2		XS5H-D421-D80-P	XS5H-D422-D80-P	
	5		XS5H-D421-G80-P	XS5H-D422-G80-P	
			XS5H-D421-A80-SA	—	
Spatter-resistant Cable	0.3	6.6 dia.	XS5H-D421-C80-SA	—	—
	1		XS5H-D421-A80-SA	—	

Note: Ask your OMRON representative about other cable lengths.



**Dimensions**

**Straight**

**Fire-retardant, Robot Cable**

**XS5H-D421-□80-F**

**Oil-resistant Polyurethane Cable**

**XS5H-D421-□80-P**

**Spatter-resistant Cable**

**XS5H-D421-□80-SA**



**Wiring Diagram for 4 Cores**

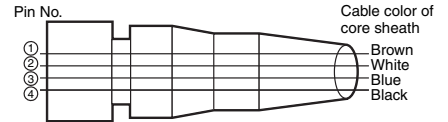

**Right-angle**

**Fire-retardant, Robot Cable**

**XS5H-D422-□80-F**

**Oil-resistant Polyurethane Cable**

**XS5H-D422-□80-P**



Note: Oil-resistant polyurethane cables (XS5H-D42□-□80-P) and spatter-resistant cables (XS5H-D421-□80-SA) have black covers.  
 Fire-retardant, robot cables (XS5H-D42□-□80-F) have warm gray covers.

# XS5 Eight-pole Connectors with Cables

## Ordering Information

Type	Cable specifications	Cable connection direction	Number of cores	Cable length L (m)	Applicable wire gauge	Model
Socket on one cable end	6.3 mm dia. AWG23 (0.25 mm <sup>2</sup> ) Structure: 0.08 mm/60 wires	Straight	8	2	—	XS5F-D821-DH0-R
				5		XS5F-D821-GH0-R
				10		XS5F-D821-JH0-R
Panel-mounting plug	—	—	—	—	AWG22 to 28	XS5M-D827-4

## Pins and Cable Lead Colors

XS5F cable lead colors	Pin No.							
	①	②	③	④	⑤	⑥	⑦	⑧
	White	Brown	Green	Yellow	Gray	Pink	Blue	Red

## Ratings and Specifications

Rated current	1.5 A
Rated voltage	36 VDC
Contact resistance	40 mΩ max. (at 20 mVDC max. and 100 mA max.)
Insulation resistance	1,000 MΩ min. (at 500 VDC)
Dielectric strength	1,000 VAC for 1 min (leakage current: 1 mA max.)
Degree of protection	IP67 (IEC60529)
Insertion tolerance	50 times
Ambient operating temperature range	-25 to 70°C
Ambient humidity range	20% to 85%

## Materials and Finish

Contacts	Brass/nickel base, 0.4-μm gold plating
Fixture	Nickel plated zinc alloy *1
Body	Nickel plated zinc alloy *2
Nut	Nickel plated brass *2
Fixtures (lock)	Stainless *2
Pin block	PBT resin (UL94V-0), light gray
Cover *1	Soft PBT resin (UL94V-0)
Seal resin *2	Rubber
O-ring *1	

\*1. XS5F only.

\*2. XS5M only.

## Dimensions

(Unit: mm)

### Socket on one cable end

XS5F-D821-□H0-R



### Front-locking, Panel-mounting Plug

XS5M-D827-4



## Panel Cutout



Panel Cutout  
Panel thickness (t): 1 to 4

# XS5G Assembly Connector Plugs

## Ordering Information

No. of poles	Connection method	Suitable cable (mm)	Core conductor size (mm <sup>2</sup> )	Suitable sheath material	Straight Connectors	Right-angle Connectors
					Model	Model
4	IDC	3 to 8 dia.	0.14 to 0.75 *1	PVC, PE, PUR	<b>XS5G-D418</b>	—
	Crimping	6 dia. (5 to 6 dia.)	0.18 to 0.3 0.5 to 0.75 *2		<b>XS5G-D4C1</b>	—
		4 dia. (4 to 5 dia.)			<b>XS5G-D4C3</b>	—
		3 dia. (3 to 4 dia.)			<b>XS5G-D4C5</b>	—
	Soldering	6 dia. (5 to 6 dia.)	0.5 max.		<b>XS5G-D421</b>	<b>XS5G-D422</b>
		4 dia. (4 to 5 dia.)			<b>XS5G-D423</b>	<b>XS5G-D424</b>
		3 dia. (3 to 4 dia.)			<b>XS5G-D425</b>	<b>XS5G-D426</b>
	Screw-on	6 dia. (5 to 6 dia.)	0.18 to 0.75		<b>XS5G-D4S1</b>	<b>XS5G-D4S2</b>
		4 dia. (4 to 5 dia.)			<b>XS5G-D4S3</b>	<b>XS5G-D4S4</b>
		3 dia. (3 to 4 dia.)			<b>XS5G-D4S5</b>	<b>XS5G-D4S6</b>
		8 dia. (7 to 8 dia.)			<b>XS5G-D4S7</b>	—
		7 dia. (6 to 7 dia.)			<b>XS5G-D4S9</b>	—
5	Screw-on	6 dia. (5 to 6 dia.)	0.18 to 0.75	<b>XS5G-D5S1</b>	—	
		4 dia. (4 to 5 dia.)		<b>XS5G-D5S3</b>	—	
		3 dia. (3 to 4 dia.)		<b>XS5G-D5S5</b>	—	
		8 dia. (7 to 8 dia.)		<b>XS5G-D5S7</b>	—	
		7 dia. (6 to 7 dia.)		<b>XS5G-D5S9</b>	—	

\*1. Minimum wire diameter: 0.08 mm, External sheath diameter of wire covering: 0.7 to 2.6 mm, Material of wire covering: PVC and PE

\*2. There are two types of contacts.

Note: XS5G Screw-on Plugs cannot be connected to side by side to the CN1 and CN2 connectors of XS2R or XS5R Y-Joint Sockets/Plugs.

Use a cable of mentioning. If you do not use one of these cables, there is a possibility that the performance can't be met.

Ask your OMRON representative about selecting a cable of other than above.

**Dimensions**

**Straight Connectors  
XS5G-D418 (IDC Model)**



**Straight Connectors  
XS5G-D4C□ (Crimping Model)  
XS5G-D42□ (Soldering Model)**

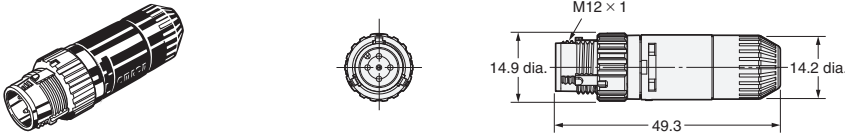

**Straight Connectors  
XS5G-D□S□ (Screw-on Connectors, Suitable Cable Dia.: 7 or 8 mm)**



**Straight Connectors  
XS5G-D□S□ (Screw-on Connectors, Suitable Cable Dia.: 3, 4, or 6 mm)**

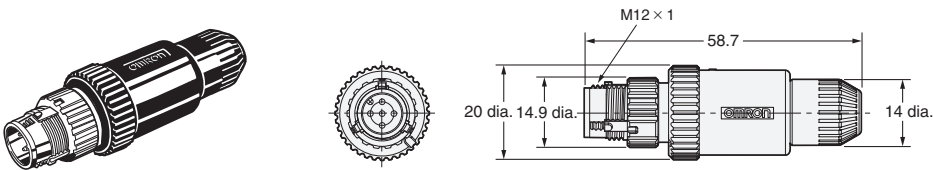

**Right-angle Connectors  
XS5G-D42□ (Soldering Model)**

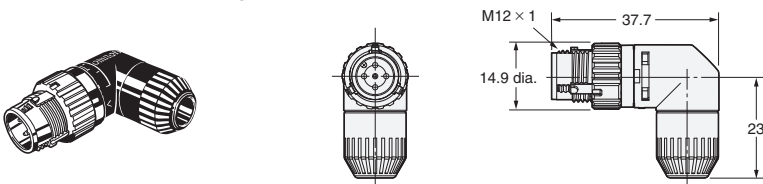

**Right-angle Connectors  
XS5G-D□S□ (Screw-on Connectors)**



# XS5U (Crimping Pin for XS5G)

## Ordering Information

Suitable core size (mm <sup>2</sup> )	Model
0.18 to 0.3	XS5U-3121
0.5 to 0.75	XS5U-3122

## Dimensions

(Unit: mm)

XS5U-312□

\* A special tool must be used for crimping. For details, refer to page 21.

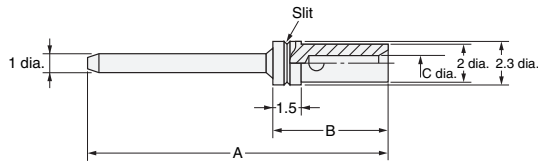
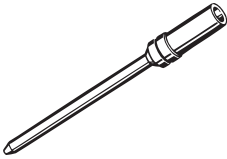

Dimensions

Model	Suitable core size (mm <sup>2</sup> )	Dimension (mm)			No. of slits
		A	B	C	
XS5U-3121	0.18 to 0.3	22.6	6.1	0.8	1
XS5U-3122	0.5 to 0.75	22.7	6.2	1.3	0

# XS5C Assembly Connector Sockets

## Ordering Information

No. of poles	Connection method	Suitable cable (mm)	Core conductor size (mm <sup>2</sup> )	Suitable sheath material	Straight Connectors	Right-angle Connectors
					Model	Model
4	IDC	3 to 8 dia.	0.14 to 0.75 *1	PVC, PE, PUR	XS5C-D418	—
	Crimping	6 dia. (5 to 6 dia.)	0.18 to 0.3 0.5 to 0.75 *2		XS5C-D4C1	XS5C-D4C2
		4 dia. (4 to 5 dia.)			XS5C-D4C3	XS5C-D4C4
		3 dia. (3 to 4 dia.)			XS5C-D4C5	XS5C-D4C6
	Soldering	6 dia. (5 to 6 dia.)	0.5 max.		XS5C-D421	XS5C-D422
		4 dia. (4 to 5 dia.)			XS5C-D423	XS5C-D424
		3 dia. (3 to 4 dia.)			XS5C-D425	XS5C-D426
	Screw-on	6 dia. (5 to 6 dia.)	0.18 to 0.75		XS5C-D4S1	XS5C-D4S2
		4 dia. (4 to 5 dia.)			XS5C-D4S3	XS5C-D4S4
		3 dia. (3 to 4 dia.)			XS5C-D4S5	XS5C-D4S6
		8 dia. (7 to 8 dia.)			XS5C-D4S7	—
		7 dia. (6 to 7 dia.)			XS5C-D4S9	—
5	Screw-on	6 dia. (5 to 6 dia.)	0.18 to 0.75	XS5C-D5S1	—	
		4 dia. (4 to 5 dia.)		XS5C-D5S3	—	
		3 dia. (3 to 4 dia.)		XS5C-D5S5	—	
		8 dia. (7 to 8 dia.)		XS5C-D5S7	—	
		7 dia. (6 to 7 dia.)		XS5C-D5S9	—	

\*1. Minimum wire diameter: 0.08 mm, External sheath diameter of wire covering: 0.7 to 2.6 mm, Material of wire covering: PVC and PE

\*2. There are two types of contacts.

Note: Use a cable of mentioning. If you do not use one of these cables, there is a possibility that the performance can't be met.

Ask your OMRON representative about selecting a cable of other than above.

**Dimensions**

**Straight Connectors**  
**XS5C-D418 (IDC Model)**

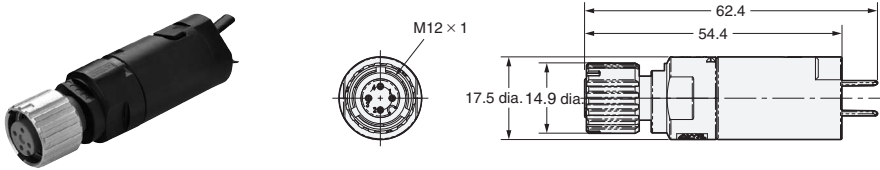

**Straight Connectors**  
**XS5C-D4C□ (Crimping Model)**  
**XS5C-D42□ (Soldering Model)**

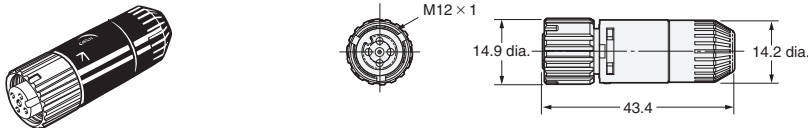

**Straight Connectors**  
**XS5C-D□S□ (Screw-on Connectors, Suitable Cable Dia.: 7 or 8 mm)**



**Straight Connectors**  
**XS5C-D□S□ (Screw-on Connectors, Suitable Cable Dia.: 3, 4, or 6 mm)**

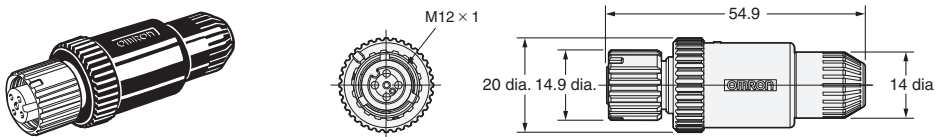

**Right-angle Connectors**  
**XS5C-D4C□ (Crimping Model)**  
**XS5C-D42□ (Soldering Model)**

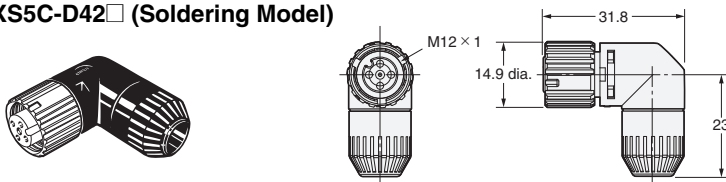

**Right-angle Connectors**  
**XS5C-D□S□ (Screw-on Connectors)**



# XS5U (Crimping Pin for XS5C)

## Ordering Information

Suitable core size (mm <sup>2</sup> )	Model
0.18 to 0.3	XS5U-2221
0.5 to 0.75	XS5U-2222

## Dimensions

(Unit: mm)

XS5U-222□

\* A special tool must be used for crimping. For details, refer to page 21.



Dimensions

Model	Suitable core size (mm <sup>2</sup> )	Dimension (mm)			No. of slits
		A	B	C	
XS5U-2221	0.18 to 0.3	16.7	6.1	0.8	1
XS5U-2222	0.5 to 0.75	16.8	6.2	1.3	0



# XS5R Y-Joint Plug/Socket Connectors

## Ordering Information

Cable	Connector	Cable length (m)	Model
With cable	Connectors on both cable ends	0.5	XS5R-D426-B11-F
		1	XS5R-D426-C11-F
		2	XS5R-D426-D11-F
		3	XS5R-D426-E11-F
	Connector on one cable end	2	XS5R-D426-D10-F
		5	XS5R-D426-G10-F

Cable	Connector	Cable length (m)	Model
Without cable	Connectors on both cable ends	—	XS5R-D426-1
		—	XS5R-D426-5

Note 1. Ask your OMRON representative about other specifications.  
 2. XS2G/XS5G Assembled Connectors with screw-on connections cannot be connected to both CN1 and CN2 at the same time.

## Dimensions

(Unit: mm)

### Connectors on Both Cable Ends (Y-Joint Plug/Socket) XS5R-D426-□11-F



#### Wiring Diagram



### Connectors on One Cable End (Y-Joint Socket) XS5R-D426-□10-F



#### Wiring Diagram



### Connectors on Both Cable Ends (Y-Joint Plug/Socket) XS5R-D426-□



#### Wiring Diagram

##### XS5R-D426-1



##### XS5R-D426-5



# XS5P Panel-mounting Sockets

## Ordering Information

Type	No. of poles	Lock	Wire length (m)	Model
With wire	4	Rear lock	0.5	XS5P-D426-5
		Front lock		XS5P-D427-5

Type	No. of poles	Lock*	Applicable wires	Model
Solder cup pins	4	Rear lock	AWG20 to AWG28	XS5P-D426-4
		Front lock		XS5P-D427-4
	5	Rear lock		XS5P-D526-4
		Front lock		XS5P-D527-4

\*Install the rear lock type from the front of the panel and tighten the nut from the rear.  
Install the front lock type from the rear of the panel and tighten the nut from the front.

## Dimensions

(Unit: mm)

### With wire

#### Rear lock

##### XS5P-D426-5



#### Wiring

Pin No.	Color
1	Brown
2	White
3	Blue
4	Black

#### Wire Specifications

Specification		UL1007
Nominal size		AWG20
Configuration	Number of wires	21
	Wire diameter	0.18
	Standard outer diameter	1.8

#### Front lock

##### XS5P-D427-5

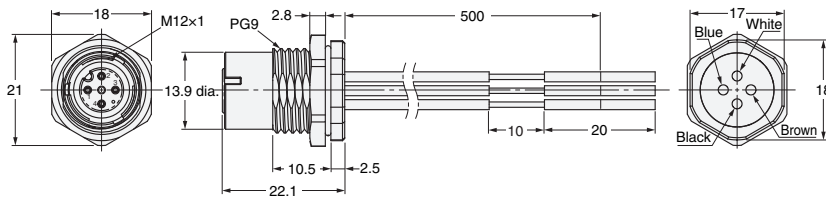

### Solder cup pins

#### Rear lock

##### XS5P-D426-4



#### Rear lock

##### XS5P-D526-4



#### Front lock

##### XS5P-D427-4



#### Front lock

##### XS5P-D527-4



## Panel Cutout



Panel Cutout Dimension  
Panel thickness = 1 to 4 mm

Note 1. The panel cutout dimension is the same for Front Locking and Rear Locking Sockets.  
2. Rotational positioning is not possible for connector rotation.

# XS5M Panel-mounting Plugs

## Ordering Information

Type	No. of poles	Lock	Wire length (m)	Model
With wire	4	Rear lock	0.5	XS5M-D426-5
		Front lock		XS5M-D427-5

Type	No. of poles	Lock*	Applicable wires	Model
Solder cup pins	4	Rear lock	AWG20 to AWG28	XS5M-D426-4
		Front lock		XS5M-D427-4
	5	Rear lock		XS5M-D526-4
		Front lock		XS5M-D527-4

\*Install the rear lock type from the front of the panel and tighten the nut from the rear.  
Install the front lock type from the rear of the panel and tighten the nut from the front.

## Dimensions

(Unit: mm)

### With wire

#### Rear lock XS5M-D426-5



### Wiring

Pin No.	Color
1	Brown
2	White
3	Blue
4	Black

#### Front lock XS5M-D427-5



### Wire Specifications

Specification	UL1007	
Nominal size	AWG20	
Configuration	Number of wires	21
	Wire diameter	0.18
	Standard outer diameter	1.8

### Solder cup pins

#### Rear lock XS5M-D426-4



#### Rear lock XS5M-D526-4



#### Front lock XS5M-D427-4



#### Front lock XS5M-D527-4



## Panel Cutout



Panel Cutout Dimension  
Panel thickness = 1 to 4 mm

- Note 1. The panel cutout dimension is the same for Front Locking and Rear Locking Sockets.  
2. Rotational positioning is not possible for connector rotation.

Connector Covers

Waterproof Covers

XS2Z-11



XS5Z-11



Application Example: XS2Z-11



The Waterproof Cover ensures IP67. When mounting the Water-resistant Cover to a Connector, be sure to apply a torque range between 0.39 and 0.49 N·m to tighten the Water-resistant Cover.

XS5Z-11 is Smartclick mechanism. There's no need to keep track of locking torque.

Model	Material	Suitable connector	
		Model	Mounting portion
XS2Z-11	Brass/nickel plated	XS5G/XS5H/XS5M/XS5R/XS5W/XS2G/XS2H/XS2M/XS2R/XS2W	M12 male screw
XS5Z-11	PBT	XS5C/XS5F/XS5P/XS5R/XS5W/XW3D	M12 female screw

Dust Covers

XS2Z-13



XS2Z-15/XS2Z-14



Application Example: XS2Z-13



The Dust Cover is for dust prevention and does not ensure IP67 degree of protection. When mounting the Dust Cover to a Connector, be sure to press the Dust Cover onto the Connector until the Connector is fully inserted into the Dust Cover.

Model	Material	Suitable connector	
		Model	Mounting portion
XS2Z-13	Rubber/black	XS5G/XS5H/XS5M/XS5R/XS5W/XS2G/XS2H/XS2M/XS2R	M12 male screw
XS2Z-14		XS5C/XS5F/XS5P/XS5R/XS5W/XS2C/XS2F/XS2P/XS2R/XS2W/XW3B/XW3D	Pin block (female pins)
XS2Z-15			M12 female screw

Sputter Protective Cover

XS2Z-31



Application Example: XS2Z-31



The Sputter Protective Cover protects the connector from weld sputter. Make sure it covers the entire connector.

Model	Material	Suitable connector
XS2Z-31	Silicone rubber/black	XS5F/XS5H/XS5W/XS2F/XS2H/XS2W

**Tools**

**Crimp Tool**

XY2F-0002

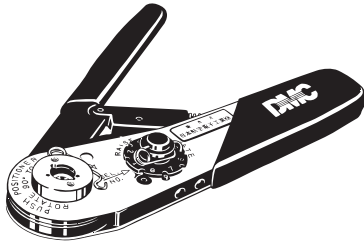

**Locator**

XY2F-0003



Use the Crimp Tool to crimp a cable core to the XS5U or XS2U Crimping Pin used with the XS□C or XS□G Crimping Connector.

- The XY2F-0002 Crimp Tool is DMC's AFM8 (M22520/2-01).
- Mount the XY2F-0003 Locator (sold separately) to the locator guide of the Crimp Tool with a screw provided with the XY2F-0003 Locator.

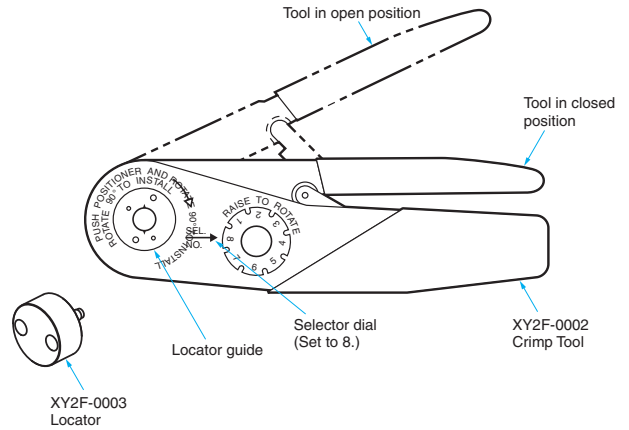

**Pin-block Extraction Tool**

XY2F-0001

Use this tool to extract a Pin Block from the covers in order to make wiring changes or corrections after the cover has been mounted to the pin block for Connector Assemblies (XS□C/ XS□G, soldering/crimping).

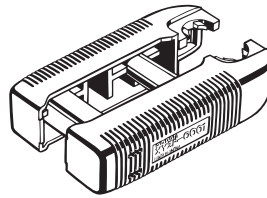

**Extraction Procedure**

(1) Disconnecting Components

- Disconnect all components on the cap side from the cover.

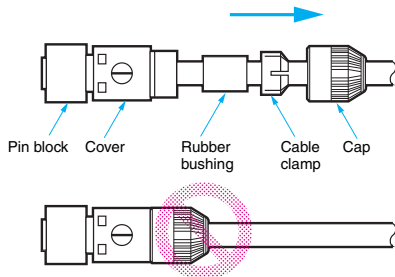

- Make sure that the pin block is outside the Tool.

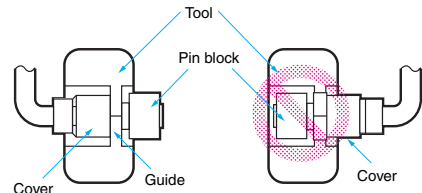

- Press the Tool so that the guides of the Tool are in close contact. Then pull the pin block straight.

(2) Extracting Pin Block

- Insert the claws of the Tool into the four holes of the cover.

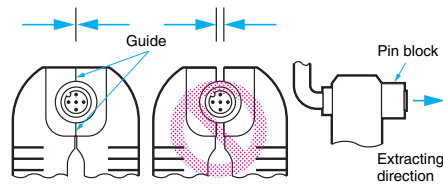
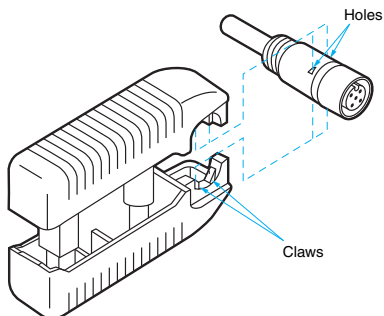

**Precautions for Correct Use**

- The pin block must not be extracted from the same Connector more than 3 times, otherwise the proper degree of protection of the pin block or Connector will not be maintained.

# Assembly Procedure for XS5C/XS5G (IDC models) Connector Assemblies

## (1) Preparations (Make sure they are all at hand.)



## (2) Dressing the cable end

- Peel covering of a cable.



External diameter of applicable cable	Core conductor size
3 to 8 mm	0.14 to 0.75 mm <sup>2</sup> / AWG26 to 18

## (3) Choose the waterproof bushing

- Choose the waterproof bushing type according to the cable size.

**External diameter of cable: In case of 3 to 5 mm**

Use the cap unit in the delivery state.



**External diameter of cable: In case of 5 to 8 mm**

When using, pick tab both sides of the waterproof bushing with a tab and pull it out in the direction of an arrow.



Note: When it isn't necessary to pull out bushing, do not pull a tab or pull out waterproof bushing carelessly. Do not insert the pulled-out bushing again.

## (4) Cable insertion

- Insert a cable in the cap unit.



\*Insert fully until a cable doesn't enter any more.  
\*It's shown by a figure in case of cable diameter 3 to 5 mm.

## (5) Wiring

- Confirm the terminal number indication<sup>\*1</sup> of a IDC (Insulation Displacement Contact) cover, insert a core wire in each wire guide according to the terminal number and push in to the lowermost part of a core wire storage part.

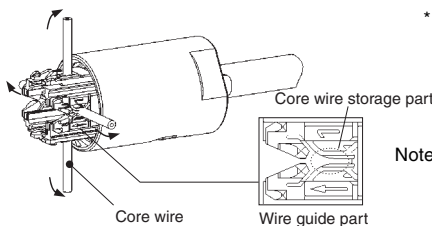

\*1. Terminal No.1: Brown  
Terminal No.2: White  
Terminal No.3: Blue  
Terminal No.4: Black

Note: There is a difference in a storing state depending on core wire diameter.

## (6) Processing the core wire end

- Cut the end part of each core wire with nippers. Cutting the core wire end in the range of cut-area of figure.

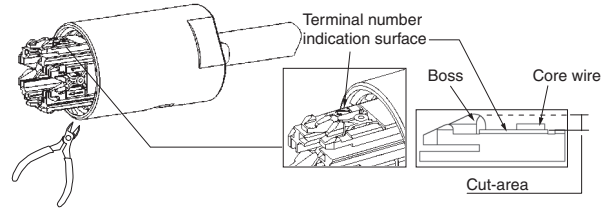

Note: Please be careful not to cut the boss.

## (7) Assembling the Pin block

- Insert the cap unit core wire end processing has completed in a pin block.
- Use a  $\triangle$  mark of a housing and an arrow of a IDC cover, as a guideline of alignment. The location of the arrow is the side of the terminal No.1.

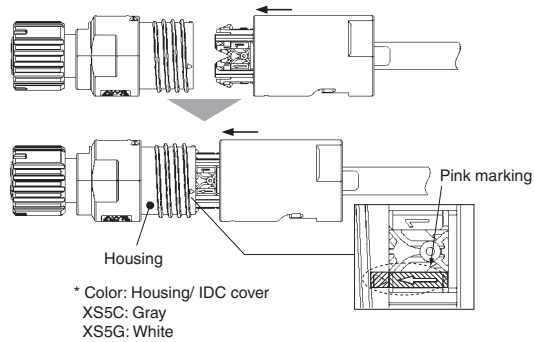

\* Color: Housing/ IDC cover  
XS5C: Gray  
XS5G: White  
Note: Confirm that the color of the housing and the IDC cover is same before insertion.

## (8) Tightening up the cap

- After inserting the cap unit and tightening a screw up lightly by hand, screw up the cap by a tool of a spanner or wrench (size 15 mm).<sup>\*2</sup>

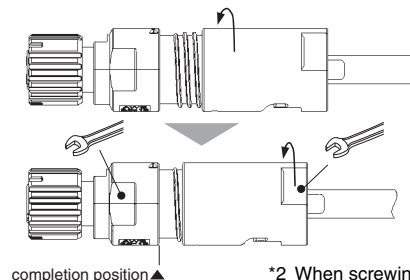

\*2 When screwing up the cap by large size tool, it may cause damage.

- When a gap between a mold cover of pin block and a cap disappeared assembly and wire connection has completed.

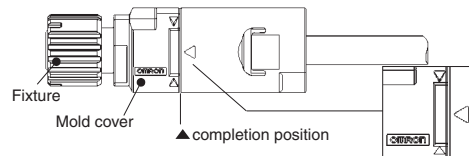

Note 1. When the operation has completed,  $\triangle$  mark of cap comes into the square of the indicator formed into a mold cover ( $\triangleright \square \triangleleft$ ), so also use it as guideline to know to complete.

2. Avoid tightening a cap up beyond the completion position. It may cause damage.

## (9) Final checking

- When the connector has been assembled, make sure the line insulation is as specified.

## Repair work procedure

### Cap unit removal

- When releasing wire connection, remove the cap unit in the opposite procedure of assembly work. [from (8) to (7)]

Note 1. The core wire remain connected to the IDC connection part rarely. In that case, remove core wire end part to the vertical direction by tweezers etc.

Do not touch the IDC contact directly at that time.

2. When IDC cover was left on the housing side, remove it by pulling a cable. In case IDC cover has been removed by holding strongly and pulling, it may cause damage.

### Cable removal

- When removing the cable from the cap unit, pull the cable to the opposite direction of assembly work procedure (4). When tip of the core wire end has been pushed lightly into the IDC cover by tweezers etc, cable removal becomes easy.

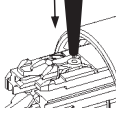

### Repair work

- When connecting the wire again, do assembly (repair work) according to assembling procedure from (1) to (8).

Note 1. In case of repair, use a cable of the same diameter and a core wire of the same diameter.

The number of times of repair wire connection is maximum 10 times.

2. When doing a repair, work after enough removing the foreign substance and moisture adhering to a connector.

Be careful so that the foreign substance and moisture do not enter the wire connection part.

It may cause short-circuit etc.

# Assembly Procedure for XS5C/XS5G (Crimping/Soldering/Screw-on models) Connector Assemblies

## (1) Connector and Cable Diameters

- Connectors for 8, 7, 6, 4, and 3 mm diameter Cables (i.e., Cables that are 7 to 8, 6 to 7, 5 to 6, 4 to 5, and 3 to 4 mm in diameter respectively) are available.
- When assembling a Connector used with a cable, make sure that the external diameter of the Connector is suited to that of the cable.
- A waterproof bushing for 6/7 mm diameter Cable has no stripe, that for 8/4 mm diameter Cable has a single stripe, and that for 3 mm diameter Cable has two stripes.

## (2) Component Insertion

### Crimping/Soldering Connectors

#### Straight Connectors

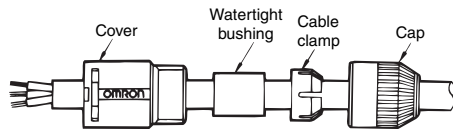

#### (Right-angle Model)

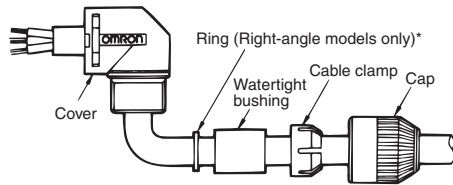

\*A ring is not required for Screw-on Connectors.

- As shown in the above illustration, connect the above components to the Cable with its end processed.

### Screw-on Connectors

Confirm that you have all of the required parts.



Insulation caps and insulation tubes are included with 5-pole Connectors (XS5C-D5S□ and XS5G-D5S□).

\*1. Rings are not required with 7-mm and 8-mm cables.  
\*2. Insert the waterproof bushing for 7-mm and 8-mm cables in the direction shown in the diagram.

## (3) Wiring (Dressing the Cable Ends)

### Soldering Connectors



- Strip 10mm of the Cable sheath and 4 mm of each core.
- Before soldering cores and solder cup pins together, solder-coat each of them.
- The following conditions are recommended for soldering each solder cup pin.  
Soldering temperature: 350±5°C  
Soldering period: 3±1 s
- The length marked \*A should be 6.5 mm max., otherwise the proper degree of protection of the connector will not be maintained.

### Crimping Connectors

#### Crimping



- Strip 14 mm of the Cable sheath and 4 mm of each core.
- Make sure that each core is not damaged and its end strands are not spread out.
- Mount the XY2F-0003 Locator to XY2F-0002 Crimp Tool, both of which are sold separately, and set the selector dial of the Crimp Tool to 8.
- After mounting the crimping pins to the Locator, fully insert the cores to the crimping pins.
- Squeeze the handle of the Crimp Tool to press-fit the cores to the crimping pins.  
(Squeeze the handle firmly until the handle automatically returns to the release position.)

#### Wiring



- After press-fitting the cores to the pins, insert the pins into the pin clamp as shown in the illustration. Then make sure that the lead colors correspond to the pin clamp numbers that are identical to the connector pin numbers.



**Insertion**



- Tentatively insert the pins to the pin block holes so that the key on the pin block will coincide with the key groove on the pin clamp. Then insert the cable along with the pin clamp.

**Screw-on Connectors**

**Dressing the Cable End**

**• Four-pole Connectors**



- Loosen the screws on pins 1 to 4 and insert the cores according to the pin numbers.



- Use the dedicated Screwdriver (XW4Z-00B)\* and tighten the screws securely so that the cores do not pull out. (0.15 to 0.2 N·m)

**• Five-pole Connectors**

- Strip the cable sheath for a total of 15 mm and strip the core covering for 8 mm for the core to connect to pin 5.



- Connect the core to pin 5 (in the center) first.
- Insert the core from the side of the hold with the tab and tighten the screw securely (tightening torque: Pins 1 to 4: 0.15 to 0.2 N·m, Pin 5: 0.03 to 0.05 N·m), and then cut off the excess wire with wire cutters.

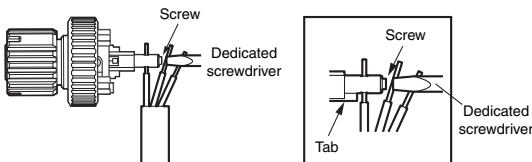

- Bend the cable as shown below, attached the enclosed insulation cap, and then strip the other cores.



- Connect the cores to pins 1 to 4.

**Connecting Shielded Cables to Five-pole Connectors**

- Place the insulation tub on the drain line of the shield and connect it to the terminal.
- Tighten the screw and then check visually to see if there is insulation between the cores.



\*When tightening the screws, use the dedicated XW4Z-00B Screwdriver that matches with the screw-slot dimensions.



**Screwdriver  
XW4Z-00B**

**(4) Inserting Pin Block**

**Pin block (Soldering Model)      Cover (Straight Model)**



**(Crimping Model)      (Right-angle Model)**



- Mount the cover to the pin block so that the triangle mark on the pin block will coincide with the triangle mark on the cover.
- If the cover is used for a Right-angle model, the relationship between the position of the polarity key on the engaged side and cable connection direction will be determined by the direction in which the positioning key is inserted into the cover, which can be rotated by 90°.
- Fully insert the positioning key until the positioning key is hidden by the casing.

## Connector Connection Procedure



- Align the triangular marks on the pin block and cover and insert the pin block into the cover.
- Press them together firmly until the pin block does not come out of the cover. (0.39 to 0.49 N·m)

### (5) Mounting Cap

- After mounting the cover to the pin block and the cover snaps into place, tighten the cap securely by hand (0.39 to 0.49 N·m)

Note: If the cap is not tighten securely enough, the degree of protection (IP67) may not be maintained or vibration may cause the cap to become loose. Do not tighten the cap with pliers or similar tools; they may damage the cap.



- After fully tightening the cap, length A should be approximately one of the following according to the cable external diameter and the Connector model. (Use these as a guide.)

External diameter of applicable cable	Cable external diameter (mm)			
	6 mm	5 mm	4 mm	3 mm
For 6-mm-dia. cable	1	0	—	—
For 4-mm-dia. cable	—	2	1	—
For 3-mm-dia. cable	—	—	2	1

### (6) After Assembly

- Confirm the insulation between cores after completing assembly.

## Recommended Cables

When connecting a commercially available cable to a connector assembly, use a cable with an outside diameter of 3 to 6 mm and core conductor sizes of 0.18 to 0.75 mm<sup>2</sup> for crimping connectors and 0.5 mm<sup>2</sup> maximum for soldering connectors.

## Connector Arrangement

For safety, when constructing a connection system between a Sensor and panel with a connector, make sure that the connector plug is on the Sensor side and the connector socket is on the panel side (i.e., the female pins are located on the power-supply side).



### 1. Connecting the XS5 Plug and Socket

- Align the projection on the plug cover with the polarity key on the socket, then insert the plug all the way in.



- Hold the knurled socket grip, then insert the projection on the plug into the groove of the socket.



- Turn the knurled grips of the socket clockwise approximately 45 degrees in respect to the plug. A click will indicate that the Connectors are locked. The locking condition can also be confirmed by the alignment marks on the plug and socket.



### 2. Connecting the XS5 and XS2

- Align the projection on the plug cover with the polarity key on the socket, then insert the plug all the way in.
- In the same way as when connecting two XS2 Connectors, screw the knurled grip in the clockwise direction.
- Use your fingers to tighten the Connectors sufficiently.

## Safety Precautions

### Definitions of Precautions

<b>Precautions for Safe Use</b>	These refer to actions that should be performed or refrained from in order to ensure safe product usage.
<b>Precautions for Correct Use</b>	These refer to actions that should be performed or refrained from in order to prevent product breakage, malfunctioning, and negative effects to performance and functionality.

### Precautions for Safe Use

#### Degree of Protection

Do not use these products if their protective structures have deteriorated, such as swelling or breakage of housing and sealing components.

If products with deteriorated protective structures continue to be used, breakage or fire damage, etc., may occur.

#### Connector Connection and Disconnection

- When connecting or disconnecting Connectors, be sure to hold the Connectors by hand.
- Do not hold the cable when disconnecting Connectors. Use after confirming the direction of the polarity key groove.
- Do not touch wiring with wet hands. Doing so may result in malfunction or breakage when the device is turned on.
- When mating Connectors, be sure to insert the plug all the way to the back of the socket before attempting to lock the Connectors. After operating the lock, always confirm that the Connector is connected.
- Do not use tools of any sort to mate the Connectors. Always use your hands. Pliers or other tools may damage the Connectors.
- When replacing the Connector, confirm that no foreign substances such as liquids or cutting oils are adhered to the connection surface of the Connector before connecting.
- When mating the Connectors to XS2 or other M12 Connectors, tighten the thread bracket by hand to a torque of 0.39 to 0.49 N·m.

### Precautions for Correct Use

- Do not use the Connectors in an atmosphere or environment that exceeds the specifications.
- Do not perform wiring while power is flowing. Doing so may result in electrical shock or device breakage.
- Do not use the Connectors in an environment where corrosive gases or high temperature/high humidity are present. Doing so may result in malfunctions such as connection/contact failures and corrosion.
- Do not pull excessively on the Connectors or cables.
- Do not step on or place any objects on the Connectors. Doing so may damage the Connectors.
- Install the Connectors in a location where they will not be stepped on, to prevent disconnection of the cables or damage to the Connectors. If the Connectors or cables must be installed where they might be stepped on, protect them with covers.
- If sensors or switches are not attached during installation, or if plug connectors are not connected, protect the mating surface of the Connector with a XS5Z-11 or XS2Z-11 Waterproof Cover or XS2Z-13/14/15 Dust Cover.

### Wiring

- Do not perform wiring in environments where the cable ends may be exposed to liquids such as water or cutting oils.
- Follow the wiring diagrams when wiring the cables. When using Sensors or Limit Switches, confirm whether connections are possible.
- Lay the cables so that external force is not applied to the Connectors. Otherwise, the degree of protection may not be achieved.

#### Degree of Protection (IP67)

- The degree of protection of Connectors (IP67) is not for a fully watertight structure. Do not use the Connectors underwater.

#### Setup

- Do not install the Connectors or cables in any way that would place a load directly on the mating section or cable connections. Doing so can damage the Connectors or break the wires inside the cables.
- Any bends made must have a minimum radius of 40 mm.

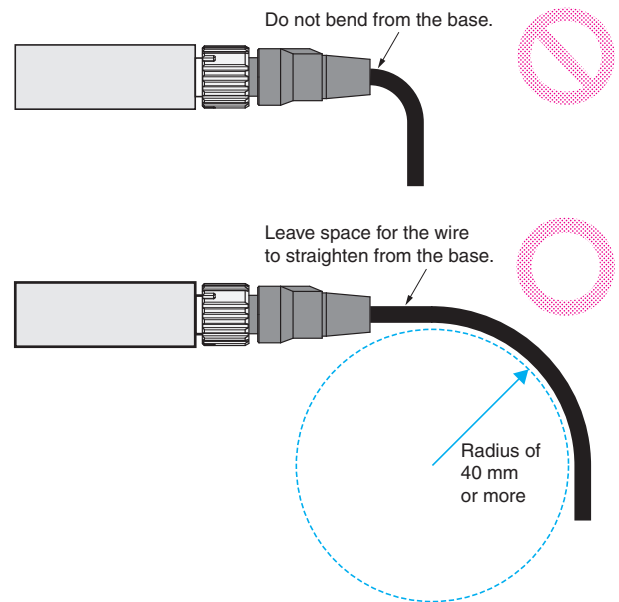

## Terms and Conditions Agreement

### Read and understand this catalog.

Please read and understand this catalog before purchasing the products. Please consult your OMRON representative if you have any questions or comments.

### Warranties.

(a) Exclusive Warranty. Omron's exclusive warranty is that the Products will be free from defects in materials and workmanship for a period of twelve months from the date of sale by Omron (or such other period expressed in writing by Omron). Omron disclaims all other warranties, express or implied.

(b) Limitations. OMRON MAKES NO WARRANTY OR REPRESENTATION, EXPRESS OR IMPLIED, ABOUT NON-INFRINGEMENT, MERCHANTABILITY OR FITNESS FOR A PARTICULAR PURPOSE OF THE PRODUCTS. BUYER ACKNOWLEDGES THAT IT ALONE HAS DETERMINED THAT THE PRODUCTS WILL SUITABLY MEET THE REQUIREMENTS OF THEIR INTENDED USE.

Omron further disclaims all warranties and responsibility of any type for claims or expenses based on infringement by the Products or otherwise of any intellectual property right. (c) Buyer Remedy. Omron's sole obligation hereunder shall be, at Omron's election, to (i) replace (in the form originally shipped with Buyer responsible for labor charges for removal or replacement thereof) the non-complying Product, (ii) repair the non-complying Product, or (iii) repay or credit Buyer an amount equal to the purchase price of the non-complying Product; provided that in no event shall Omron be responsible for warranty, repair, indemnity or any other claims or expenses regarding the Products unless Omron's analysis confirms that the Products were properly handled, stored, installed and maintained and not subject to contamination, abuse, misuse or inappropriate modification. Return of any Products by Buyer must be approved in writing by Omron before shipment. Omron Companies shall not be liable for the suitability or unsuitability or the results from the use of Products in combination with any electrical or electronic components, circuits, system assemblies or any other materials or substances or environments. Any advice, recommendations or information given orally or in writing, are not to be construed as an amendment or addition to the above warranty.

See <http://www.omron.com/global/> or contact your Omron representative for published information.

### Limitation on Liability: Etc.

OMRON COMPANIES SHALL NOT BE LIABLE FOR SPECIAL, INDIRECT, INCIDENTAL, OR CONSEQUENTIAL DAMAGES, LOSS OF PROFITS OR PRODUCTION OR COMMERCIAL LOSS IN ANY WAY CONNECTED WITH THE PRODUCTS, WHETHER SUCH CLAIM IS BASED IN CONTRACT, WARRANTY, NEGLIGENCE OR STRICT LIABILITY.

Further, in no event shall liability of Omron Companies exceed the individual price of the Product on which liability is asserted.

### Suitability of Use.

Omron Companies shall not be responsible for conformity with any standards, codes or regulations which apply to the combination of the Product in the Buyer's application or use of the Product. At Buyer's request, Omron will provide applicable third party certification documents identifying ratings and limitations of use which apply to the Product. This information by itself is not sufficient for a complete determination of the suitability of the Product in combination with the end product, machine, system, or other application or use. Buyer shall be solely responsible for determining appropriateness of the particular Product with respect to Buyer's application, product or system. Buyer shall take application responsibility in all cases.

NEVER USE THE PRODUCT FOR AN APPLICATION INVOLVING SERIOUS RISK TO LIFE OR PROPERTY OR IN LARGE QUANTITIES WITHOUT ENSURING THAT THE SYSTEM AS A WHOLE HAS BEEN DESIGNED TO ADDRESS THE RISKS, AND THAT THE OMRON PRODUCT(S) IS PROPERLY RATED AND INSTALLED FOR THE INTENDED USE WITHIN THE OVERALL EQUIPMENT OR SYSTEM.

### Programmable Products.

Omron Companies shall not be responsible for the user's programming of a programmable Product, or any consequence thereof.

### Performance Data.

Data presented in Omron Company websites, catalogs and other materials is provided as a guide for the user in determining suitability and does not constitute a warranty. It may represent the result of Omron's test conditions, and the user must correlate it to actual application requirements. Actual performance is subject to the Omron's Warranty and Limitations of Liability.

### Change in Specifications.

Product specifications and accessories may be changed at any time based on improvements and other reasons. It is our practice to change part numbers when published ratings or features are changed, or when significant construction changes are made. However, some specifications of the Product may be changed without any notice. When in doubt, special part numbers may be assigned to fix or establish key specifications for your application. Please consult with your Omron's representative at any time to confirm actual specifications of purchased Product.

### Errors and Omissions.

Information presented by Omron Companies has been checked and is believed to be accurate; however, no responsibility is assumed for clerical, typographical or proofreading errors or omissions.

# Mouser Electronics

Authorized Distributor

Click to View Pricing, Inventory, Delivery & Lifecycle Information:

## Omron:

[XS5M-D427-5](#) [XS5R-D426-5](#) [XS5M-D426-5](#) [XS5P-D426-5](#) [XS5P-D427-5](#) [XS5R-D426-1](#) [XW3D-P452-G11](#) [XW3D-P453-G11](#) [XW3D-P455-G11](#) [XW3D-P457-G11](#) [XW3D-P458-G11](#) [XW3D-P852-G11](#) [XW3D-P853-G11](#) [XW3D-P855-G11](#) [XS5G-D4S1](#) [XS5G-D4S9](#) [XS5G-D4S5](#) [XS5C-D4S7](#) [XS5G-D421](#) [XS5C-D4S3](#) [XS5C-D4S2](#) [XS5C-D4S5](#) [XS5G-D4S4](#) [XS5G-D4S7](#) [XS5C-D4S4](#) [XS5G-D4S6](#) [XS5C-D4S1](#) [XS5C-D4S6](#) [XS5G-D4S2](#) [XS5C-D4S9](#) [XS5C-D4C5](#) [XS5C-D5S7](#) [XS5G-D5S9](#) [XS5G-D5S7](#) [XS5C-D426](#) [XS5C-D422](#) [XS5G-D5S1](#) [XS5G-D426](#) [XS5C-D5S3](#) [XS5C-D5S1](#) [XS5C-D5S9](#) [XS5C-D5S5](#) [XS5G-D5S5](#) [XS5G-D5S3](#) [XS5C-D4C2](#) [XS5C-D423](#) [XS5C-D4C6](#) [XS5G-D425](#) [XS5C-D4C4](#) [XS5G-D423](#) [XS5C-D424](#) [XS5G-D4C1](#) [XS5C-D421](#) [XS5G-D424](#) [XS5C-D4C3](#) [XS5G-D4S3](#) [XS5G-D422](#) [XS5C-D4C1](#) [XS5G-D4C5](#) [XS5C-D425](#) [XS5P-T426-1](#) [XS5C-D418](#) [XS5G-D418](#) [XS5W-D422-H81-F](#) [XS5U-3121](#) [XS5U-3122](#) [XS5U-2221](#)

Компания «Life Electronics» занимается поставками электронных компонентов импортного и отечественного производства от производителей и со складов крупных дистрибьюторов Европы, Америки и Азии.

С конца 2013 года компания активно расширяет линейку поставок компонентов по направлению коаксиальный кабель, кварцевые генераторы и конденсаторы (керамические, пленочные, электролитические), за счёт заключения дистрибьюторских договоров

Мы предлагаем:

- Конкуренеспособные цены и скидки постоянным клиентам.
- Специальные условия для постоянных клиентов.
- Подбор аналогов.
- Поставку компонентов в любых объемах, удовлетворяющих вашим потребностям.
- Приемлемые сроки поставки, возможна ускоренная поставка.
- Доставку товара в любую точку России и стран СНГ.
- Комплексную поставку.
- Работу по проектам и поставку образцов.
- Формирование склада под заказчика.
- Сертификаты соответствия на поставляемую продукцию (по желанию клиента).
- Тестирование поставляемой продукции.
- Поставку компонентов, требующих военную и космическую приемку.
- Входной контроль качества.
- Наличие сертификата ISO.

В составе нашей компании организован Конструкторский отдел, призванный помогать разработчикам, и инженерам.

Конструкторский отдел помогает осуществить:

- Регистрацию проекта у производителя компонентов.
- Техническую поддержку проекта.
- Защиту от снятия компонента с производства.
- Оценку стоимости проекта по компонентам.
- Изготовление тестовой платы монтаж и пусконаладочные работы.



Тел: +7 (812) 336 43 04 (многоканальный)

Email: [org@lifeelectronics.ru](mailto:org@lifeelectronics.ru)