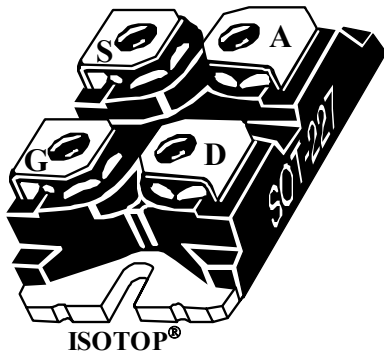
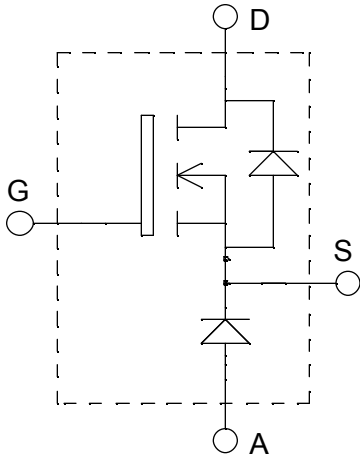


**ISOTOP[®] Buck chopper
Super Junction
MOSFET Power Module**

**$V_{DSS} = 600V$
 $R_{DSon} = 70m\Omega$ max @ $T_j = 25^\circ C$
 $I_D = 40A$ @ $T_c = 25^\circ C$**


Application

- AC and DC motor control
- Switched Mode Power Supplies

Features

- **COOLMOS[®]** Power Semiconductors
 - Ultra low R_{DSon}
 - Low Miller capacitance
 - Ultra low gate charge
 - Avalanche energy rated
- ISOTOP[®] Package (SOT-227)
- Very low stray inductance
- High level of integration

Benefits

- Outstanding performance at high frequency operation
- Stable temperature behavior
- Very rugged
- Direct mounting to heatsink (isolated package)
- Low junction to case thermal resistance
- Easy paralleling due to positive T_c of V_{CEsat}
- RoHS Compliant

Absolute maximum ratings

Symbol	Parameter	Max ratings	Unit	
V_{DSS}	Drain - Source Breakdown Voltage	600	V	
I_D	Continuous Drain Current	$T_c = 25^\circ C$	40	
		$T_c = 80^\circ C$	30	
I_{DM}	Pulsed Drain current	120	A	
V_{GS}	Gate - Source Voltage	± 20	V	
R_{DSon}	Drain - Source ON Resistance	70	$m\Omega$	
P_D	Maximum Power Dissipation	$T_c = 25^\circ C$	290	
I_{AR}	Avalanche current (repetitive and non repetitive)	20	A	
E_{AR}	Repetitive Avalanche Energy	1	mJ	
E_{AS}	Single Pulse Avalanche Energy	1800		
$I_{F_{AV}}$	Maximum Average Forward Current	Duty cycle=0.5	$T_c = 80^\circ C$	30
$I_{F_{RMS}}$	RMS Forward Current (Square wave, 50% duty)			39

CAUTION: These Devices are sensitive to Electrostatic Discharge. Proper Handling Procedures Should Be Followed.

All ratings @ $T_j = 25^\circ\text{C}$ unless otherwise specified

Electrical Characteristics

Symbol	Characteristic	Test Conditions	Min	Typ	Max	Unit
I_{DSS}	Zero Gate Voltage Drain Current	$V_{GS} = 0\text{V}, V_{DS} = 600\text{V}$			25	μA
		$T_j = 25^\circ\text{C}$				
		$T_j = 125^\circ\text{C}$			250	
$R_{DS(on)}$	Drain – Source on Resistance	$V_{GS} = 10\text{V}, I_D = 20\text{A}$			70	$\text{m}\Omega$
$V_{GS(th)}$	Gate Threshold Voltage	$V_{GS} = V_{DS}, I_D = 1\text{mA}$	2.1	3	3.9	V
I_{GSS}	Gate – Source Leakage Current	$V_{GS} = \pm 20\text{V}, V_{DS} = 0\text{V}$			± 100	nA

Dynamic Characteristics

Symbol	Characteristic	Test Conditions	Min	Typ	Max	Unit
C_{iss}	Input Capacitance	$V_{GS} = 0\text{V}$ $V_{DS} = 25\text{V}$ $f = 1\text{MHz}$		7015		pF
C_{oss}	Output Capacitance			2565		
C_{rss}	Reverse Transfer Capacitance			212		
Q_g	Total gate Charge	$V_{GS} = 10\text{V}$ $V_{Bus} = 300\text{V}$ $I_D = 40\text{A}$		259		nC
Q_{gs}	Gate – Source Charge			29		
Q_{gd}	Gate – Drain Charge			111		
$T_{d(on)}$	Turn-on Delay Time	Resistive Switching $V_{GS} = 15\text{V}$ $V_{Bus} = 380\text{V}$ $I_D = 40\text{A}$ $R_G = 1.8\Omega$		20		ns
T_r	Rise Time			30		
$T_{d(off)}$	Turn-off Delay Time			115		
T_f	Fall Time			10		
Eon	Turn-on Switching Energy	Inductive switching @ 25°C $V_{GS} = 15\text{V}, V_{Bus} = 400\text{V}$ $I_D = 40\text{A}, R_G = 5\Omega$		670		μJ
Eoff	Turn-off Switching Energy			980		
Eon	Turn-on Switching Energy	Inductive switching @ 125°C $V_{GS} = 15\text{V}, V_{Bus} = 400\text{V}$ $I_D = 40\text{A}, R_G = 5\Omega$		1100		μJ
Eoff	Turn-off Switching Energy			1206		

Chopper diode ratings and characteristics

Symbol	Characteristic	Test Conditions	Min	Typ	Max	Unit	
V _F	Diode Forward Voltage	I _F = 30A		1.6	1.8	V	
		I _F = 60A		1.9			
		I _F = 30A	T _j = 125°C		1.4		
I _{RM}	Maximum Reverse Leakage Current	V _R = 600V			250	μA	
		V _R = 600V	T _j = 125°C		500		
C _T	Junction Capacitance	V _R = 200V		44		pF	
t _{rr}	Reverse Recovery Time	I _F =1A, V _R =30V di/dt = 100A/μs	T _j = 25°C	23		ns	
	Reverse Recovery Time	I _F = 30A V _R = 400V di/dt = 200A/μs	T _j = 25°C	85			
I _{RRM}	Maximum Reverse Recovery Current		T _j = 125°C	160			
			T _j = 25°C	4			
Q _{rr}	Reverse Recovery Charge			T _j = 125°C	8		
		T _j = 25°C		130			
t _{rr}	Reverse Recovery Time	I _F = 30A		T _j = 125°C	70		ns
	Reverse Recovery Charge	V _R = 400V			1300		nC
I _{RRM}	Maximum Reverse Recovery Current	di/dt = 1000A/μs	30			A	

Thermal and package characteristics

Symbol	Characteristic	Min	Typ	Max	Unit
R _{thJC}	Junction to Case Thermal Resistance	CoolMos		0.43	°C/W
		Diode		1.21	
R _{thJA}	Junction to Ambient (IGBT & Diode)			20	
V _{ISOL}	RMS Isolation Voltage, any terminal to case t = 1 min, I _{isol} < 1mA, 50/60Hz	2500			V
T _J , T _{STG}	Storage Temperature Range	-55		150	°C
T _L	Max Lead Temp for Soldering: 0.063" from case for 10 sec			300	
Torque	Mounting torque (Mounting = 8-32 or 4mm Machine and terminals = 4mm Machine)			1.5	N.m
Wt	Package Weight		29.2		g

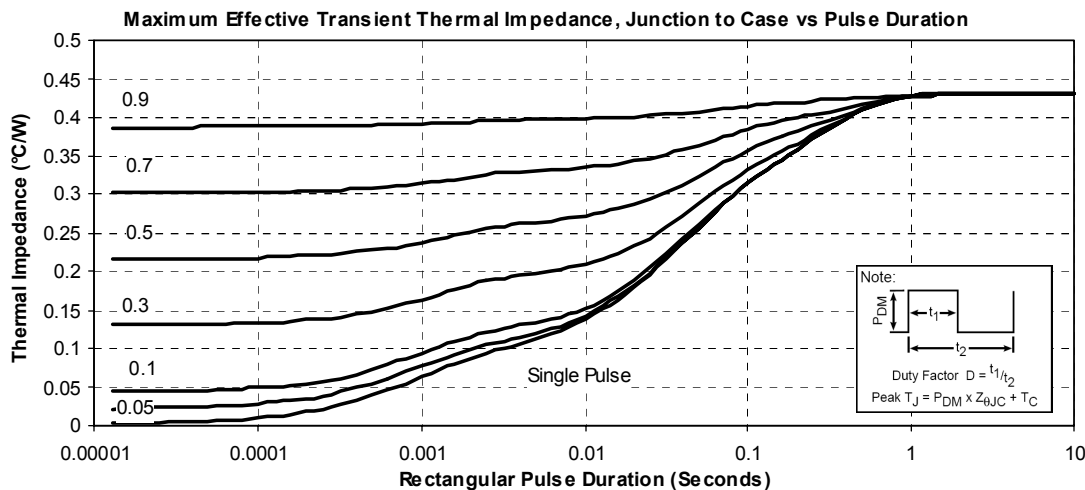
Typical CoolMOS Performance Curve


Fig 1, Maximum Effective transient thermal Impedance, Junction to case vs Pulse Duration

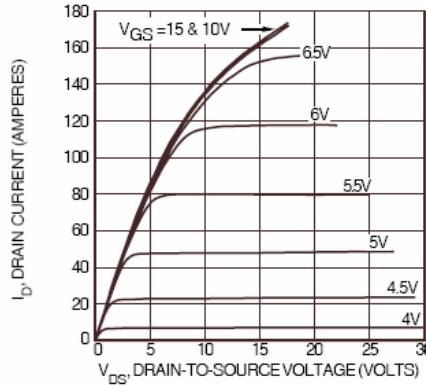


FIGURE 3, LOW VOLTAGE OUTPUT CHARACTERISTICS

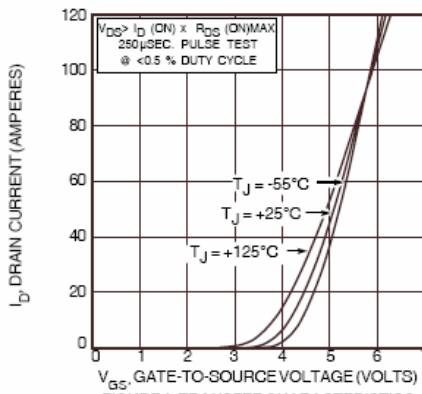


FIGURE 4, TRANSFER CHARACTERISTICS

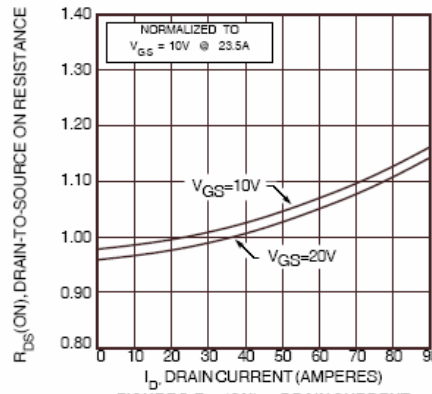


FIGURE 5, $R_{DS(ON)}$ vs DRAIN CURRENT

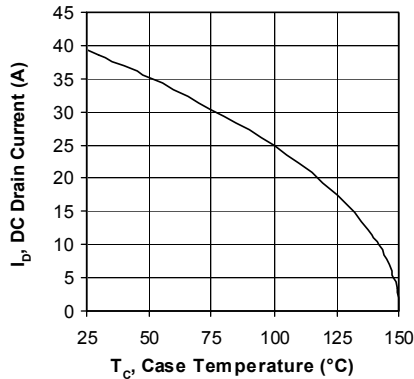


Figure 6, DC Drain Current vs Case Temperature

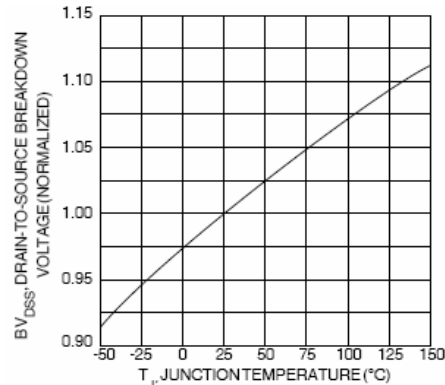


FIGURE 7, BREAKDOWN VOLTAGE vs TEMPERATURE

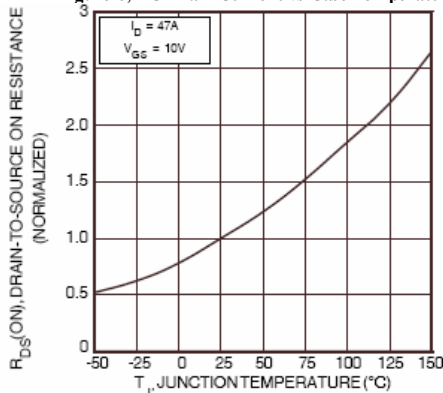


FIGURE 8, ON-RESISTANCE vs. TEMPERATURE

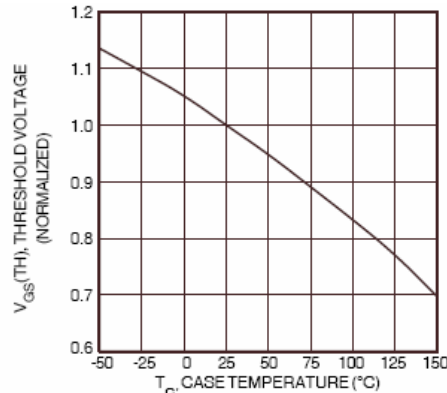


FIGURE 9, THRESHOLD VOLTAGE vs TEMPERATURE

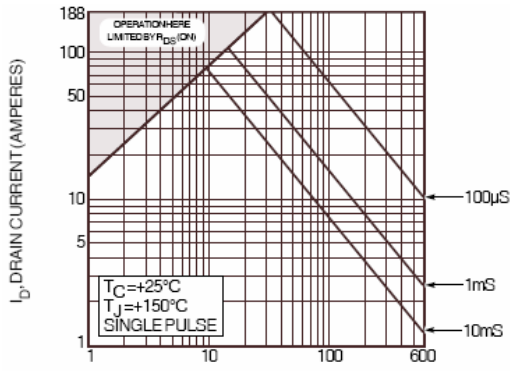


FIGURE 10, MAXIMUM SAFE OPERATING AREA

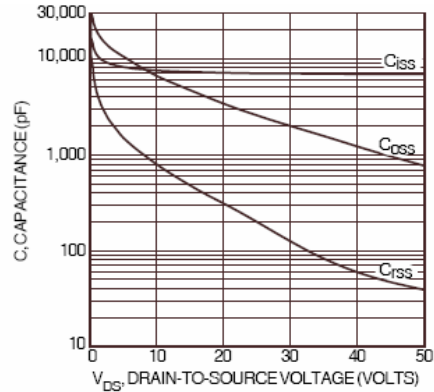


FIGURE 11, CAPACITANCE vs DRAIN-TO-SOURCE VOLTAGE

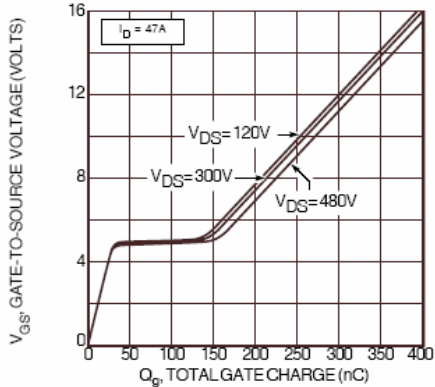


FIGURE 12, GATE CHARGES vs GATE-TO-SOURCE VOLTAGE

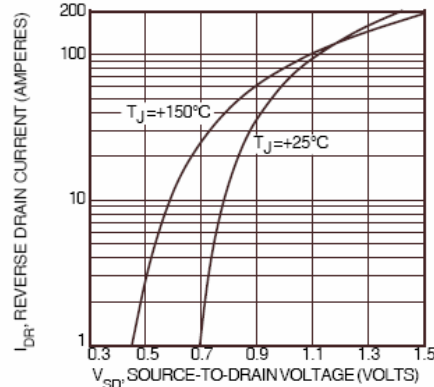


FIGURE 13, SOURCE-DRAIN DIODE FORWARD VOLTAGE

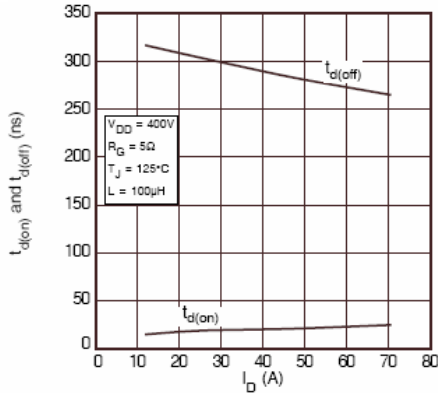


FIGURE 14, DELAY TIMES vs CURRENT

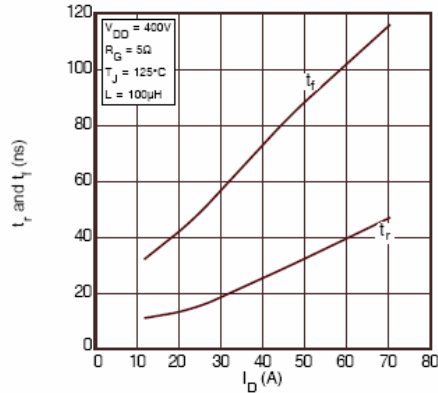


FIGURE 15, RISE AND FALL TIMES vs CURRENT

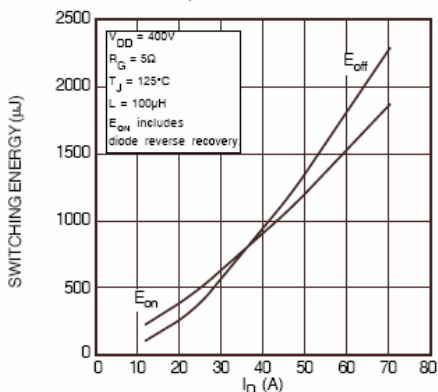


FIGURE 16, SWITCHING ENERGY vs CURRENT

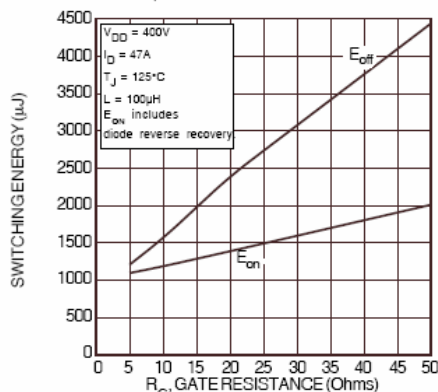


FIGURE 17, SWITCHING ENERGY vs. GATE RESISTANCE

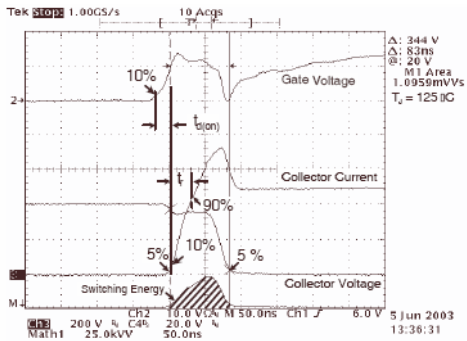


Figure 18, Turn-on Switching Waveforms and Definitions

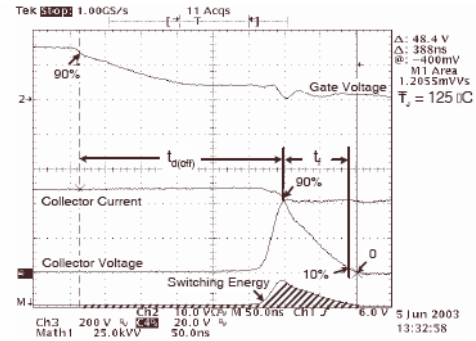


Figure 19, Turn-off Switching Waveforms and Definitions

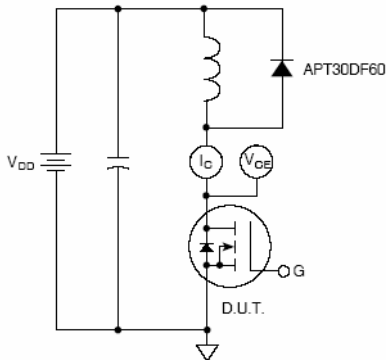


Figure 20, Inductive Switching Test Circuit

Typical Diode Performance Curve

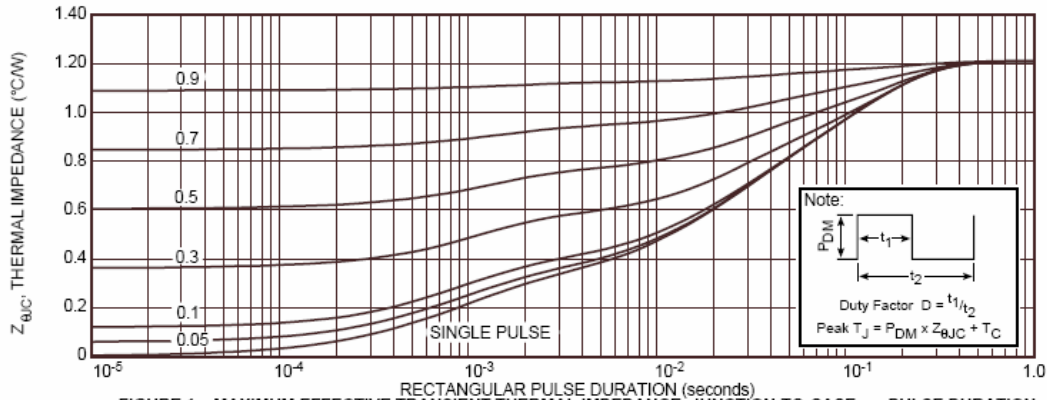


FIGURE 1a. MAXIMUM EFFECTIVE TRANSIENT THERMAL IMPEDANCE, JUNCTION-TO-CASE vs. PULSE DURATION

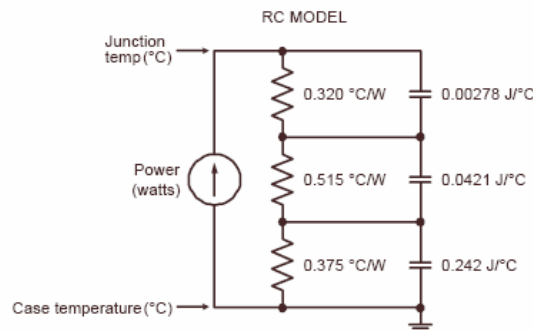


FIGURE 1b, TRANSIENT THERMAL IMPEDANCE MODEL

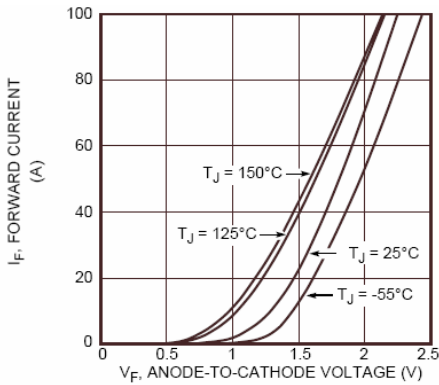


Figure 2. Forward Current vs. Forward Voltage

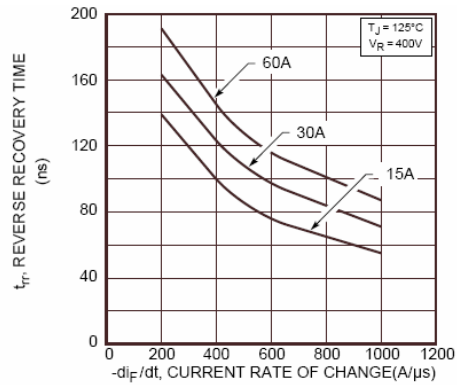


Figure 3. Reverse Recovery Time vs. Current Rate of Change

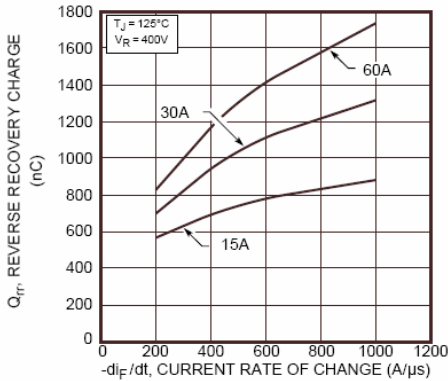


Figure 4. Reverse Recovery Charge vs. Current Rate of Change

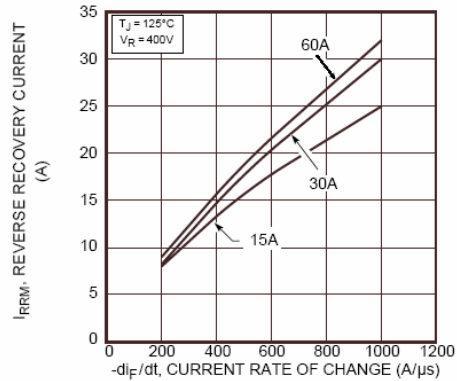


Figure 5. Reverse Recovery Current vs. Current Rate of Change

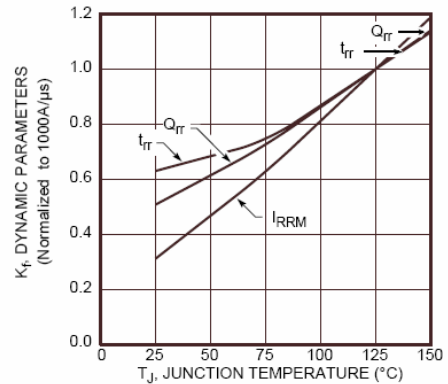


Figure 6. Dynamic Parameters vs. Junction Temperature

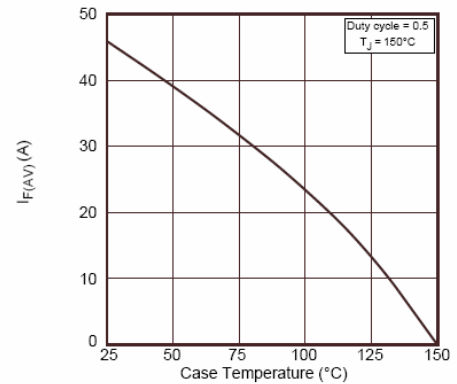


Figure 7. Maximum Average Forward Current vs. Case Temperature

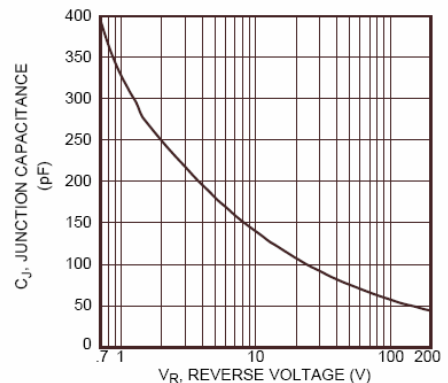


Figure 8. Junction Capacitance vs. Reverse Voltage

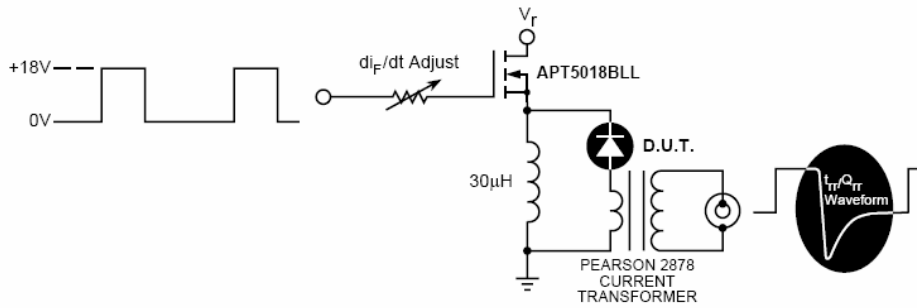


Figure 9. Diode Test Circuit

- 1 I_F - Forward Conduction Current
- 2 di_F/dt - Rate of Diode Current Change Through Zero Crossing.
- 3 I_{RRM} - Maximum Reverse Recovery Current.
- 4 t_{rr} - Reverse Recovery Time, measured from zero crossing where diode current goes from positive to negative, to the point at which the straight line through I_{RRM} and $0.25 \cdot I_{RRM}$ passes through zero.
- 5 Q_{rr} - Area Under the Curve Defined by I_{RRM} and t_{rr} .

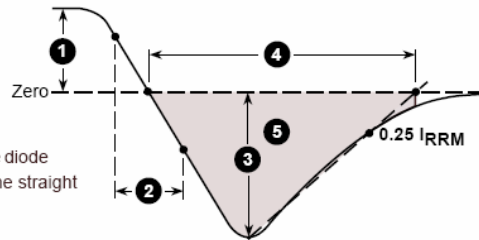
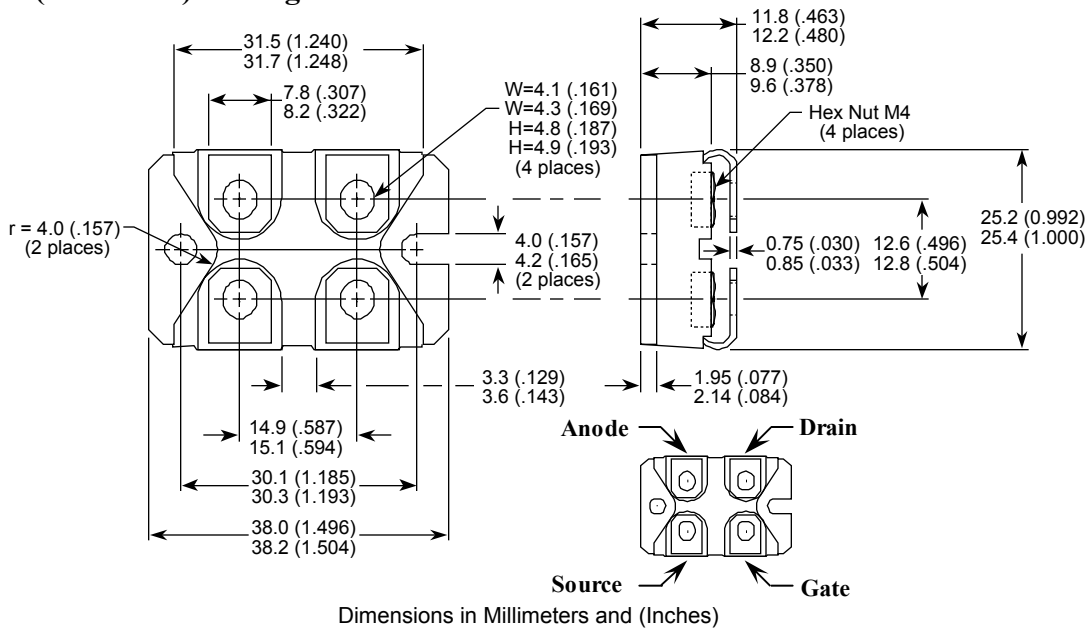


Figure 10. Diode Reverse Recovery Waveform and Definitions

SOT-227 (ISOTOP[®]) Package Outline



“COOLMOS[™] comprise a new family of transistors developed by Infineon Technologies AG. “COOLMOS” is a trademark of Infineon Technologies AG”.

ISOTOP[®] is a registered trademark of ST Microelectronics NV

Microsemi reserves the right to change, without notice, the specifications and information contained herein

Microsemi's products are covered by one or more of U.S. patents 4,895,810 5,045,903 5,089,434 5,182,234 5,019,522 5,262,336 6,503,786 5,256,583 4,748,103 5,283,202 5,231,474 5,434,095 5,528,058 and foreign patents. U.S. and Foreign patents pending. All Rights Reserved.

Компания «Life Electronics» занимается поставками электронных компонентов импортного и отечественного производства от производителей и со складов крупных дистрибьюторов Европы, Америки и Азии.

С конца 2013 года компания активно расширяет линейку поставок компонентов по направлению коаксиальный кабель, кварцевые генераторы и конденсаторы (керамические, пленочные, электролитические), за счёт заключения дистрибьюторских договоров

Мы предлагаем:

- Конкурентоспособные цены и скидки постоянным клиентам.
- Специальные условия для постоянных клиентов.
- Подбор аналогов.
- Поставку компонентов в любых объемах, удовлетворяющих вашим потребностям.
- Приемлемые сроки поставки, возможна ускоренная поставка.
- Доставку товара в любую точку России и стран СНГ.
- Комплексную поставку.
- Работу по проектам и поставку образцов.
- Формирование склада под заказчика.
- Сертификаты соответствия на поставляемую продукцию (по желанию клиента).
- Тестирование поставляемой продукции.
- Поставку компонентов, требующих военную и космическую приемку.
- Входной контроль качества.
- Наличие сертификата ISO.

В составе нашей компании организован Конструкторский отдел, призванный помогать разработчикам, и инженерам.

Конструкторский отдел помогает осуществить:

- Регистрацию проекта у производителя компонентов.
- Техническую поддержку проекта.
- Защиту от снятия компонента с производства.
- Оценку стоимости проекта по компонентам.
- Изготовление тестовой платы монтаж и пусконаладочные работы.



Тел: +7 (812) 336 43 04 (многоканальный)

Email: org@lifeelectronics.ru