

# MAX4194–MAX4197

# Micropower, Single-Supply, Rail-to-Rail, Precision Instrumentation Amplifiers

## General Description

The MAX4194 is a variable-gain precision instrumentation amplifier that combines Rail-to-Rail® single-supply operation, outstanding precision specifications, and a high gain bandwidth. This amplifier is also offered in three fixed-gain versions: the MAX4195 (G = +1V/V), the MAX4196 (G = +10V/V), and the MAX4197 (G = +100V/V). The fixed-gain instrumentation amplifiers feature a shutdown function that reduces the quiescent current to 8µA. A traditional three operational amplifier configuration is used to achieve maximum DC precision.

The MAX4194–MAX4197 have rail-to-rail outputs and inputs that can swing to 200mV below the negative rail and to within 1.1V of the positive rail. All parts draw only 93µA and operate from a single +2.7V to +7.5V supply or from dual ±1.35V to ±3.75V supplies. These amplifiers are offered in 8-pin SO packages and are specified for the extended temperature range (-40°C to +85°C).

See the MAX4198/MAX4199 data sheet for single-supply, precision differential amplifiers.

## Applications

- Medical Equipment
- Thermocouple Amplifier
- 4–20mA Loop Transmitters
- Data-Acquisition Systems
- Battery-Powered/Portable Equipment
- Transducer Interface
- Bridge Amplifier

## Pin Configurations

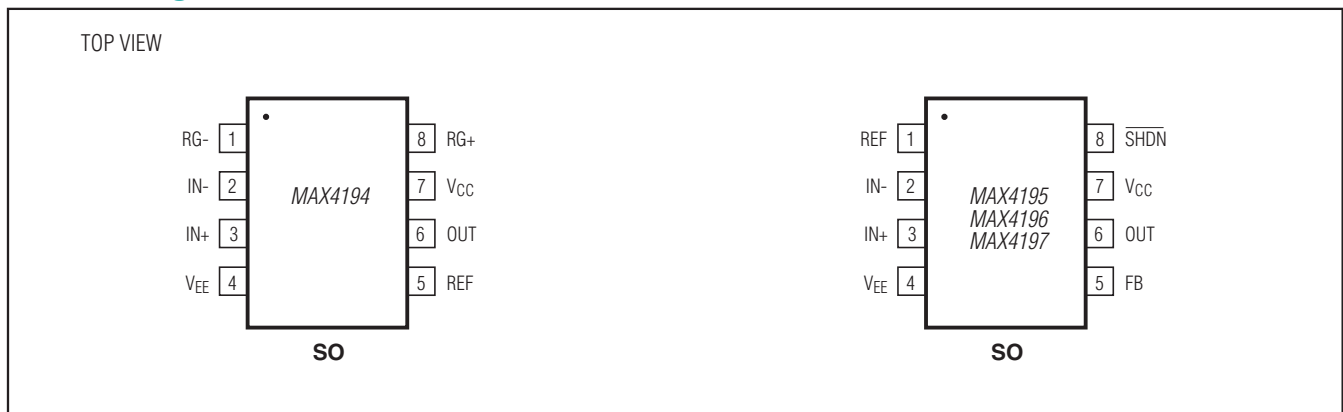

Rail-to-Rail is a registered trademark of Nippon Motorola, Ltd.

## Benefits and Features

- Low Power Consumption Is Ideal for Remote-Sensing and Battery-Powered Applications
  - +2.7V Single-Supply Operation
  - Low Power Consumption
    - 93µA Supply Current
    - 8µA Shutdown Current (MAX4195/MAX4196/MAX4197)
- Precision Specifications Maximize Sensor Performance
  - High Common-Mode Rejection: 115dB (G = +10V/V)
  - Input Common-Mode Range Extends 200mV Below GND
  - Low 50µV Input Offset Voltage (G ≥ +100V/V)
  - Low ±0.01% Gain Error (G = +1V/V)
  - 250kHz -3dB Bandwidth (G = +1V/V, MAX4194)
  - Rail-to-Rail Outputs

## Ordering Information

PART	TEMP RANGE	PIN-PACKAGE
MAX4194ESA	-40°C to +85°C	8 SO
MAX4195ESA	-40°C to +85°C	8 SO
MAX4196ESA	-40°C to +85°C	8 SO
MAX4197ESA	-40°C to +85°C	8 SO

## Selector Guide

PART	SHUTDOWN	GAIN (V/V)	CMRR (dB)
MAX4194	No	Variable	95 (G = +1V/V)
MAX4195	Yes	+1	95
MAX4196	Yes	+10	115
MAX4197	Yes	+100	115

Supply Voltage ( $V_{CC}$  to  $V_{EE}$ ).....+8V  
 All Other Pins ..... ( $V_{CC} + 0.3V$ ) to ( $V_{EE} - 0.3V$ )  
 Current into Any Pin..... $\pm 30mA$   
 Output Short-Circuit Duration (to  $V_{CC}$  or  $V_{EE}$ )..... Continuous  
 Continuous Power Dissipation ( $T_A = +70^\circ C$ )  
 8-Pin SO (derate  $5.9mW/^\circ C$  above  $+70^\circ C$ )..... 471mW

Operating Temperature Range ..... $-40^\circ C$  to  $+85^\circ C$   
 Junction Temperature ..... $+150^\circ C$   
 Storage Temperature Range ..... $-65^\circ C$  to  $+150^\circ C$   
 Lead Temperature (soldering, 10s) .....  $+300^\circ C$

Stresses beyond those listed under "Absolute Maximum Ratings" may cause permanent damage to the device. These are stress ratings only, and functional operation of the device at these or any other conditions beyond those indicated in the operational sections of the specifications is not implied. Exposure to absolute maximum rating conditions for extended periods may affect device reliability.

### Electrical Characteristics

( $V_{CC} = +5V$ ,  $V_{EE} = 0V$ ,  $R_L = 25k\Omega$  tied to  $V_{CC}/2$ ,  $V_{REF} = V_{CC}/2$ ,  $T_A = T_{MIN}$  to  $T_{MAX}$ , unless otherwise noted. Typical values are at  $T_A = +25^\circ C$ .)

PARAMETER	SYMBOL	CONDITIONS	MIN	TYP	MAX	UNITS
Supply Voltage Range	$V_{CC}$	Inferred by PSR test	Single supply	2.7	7.5	V
			Dual supplies	$\pm 1.35$	$\pm 3.75$	
Quiescent Current	$I_{CC}$	$V_{IN+} = V_{IN-} = V_{CC}/2$ , $V_{DIFF} = 0V$		93	110	$\mu A$
Shutdown Current	$I_{SHDN}$	$I_{SHDN} = V_{IL}$ , MAX4195/MAX4196/MAX4197 only		8	12	$\mu A$
Input Offset Voltage	$V_{OS}$	$G = +1V/V$ , $V_{CM} = V_{CC}/2$ , $T_A = +25^\circ C$		$\pm 100$	$\pm 450$	$\mu V$
		$G = +10V/V$ , $V_{CM} = V_{CC}/2$ , $T_A = +25^\circ C$		$\pm 75$	$\pm 225$	
		$G = +100V/V$ , $V_{CM} = V_{CC}/2$ , $T_A = +25^\circ C$		$\pm 50$	$\pm 225$	
		$G = +1000V/V$ , $V_{CM} = V_{CC}/2$ , $T_A = +25^\circ C$		$\pm 50$		
		$G = +1V/V$ , $V_{CM} = V_{CC}/2$ , $T_A = T_{MIN}$ to $T_{MAX}$		$\pm 100$	$\pm 690$	
		$G = +1V/V$ , $V_{CM} = V_{CC}/2$ , $T_A = T_{MIN}$ to $T_{MAX}$		$\pm 75$	$\pm 345$	
		$G = +100V/V$ , $V_{CM} = V_{CC}/2$ , $T_A = T_{MIN}$ to $T_{MAX}$		$\pm 50$	$\pm 345$	
		$G = +1000V/V$ , $V_{CM} = V_{CC}/2$ , $T_A = T_{MIN}$ to $T_{MAX}$		$\pm 50$		
Input Offset Voltage Drift (Note 1)	$TC_{VOS}$	$G = +1V/V$		$\pm 1.0$	$\pm 4.0$	$\mu V/^\circ C$
		$G \geq +10V/V$		$\pm 0.5$	$\pm 2.0$	
Input Resistance	$R_{IN}$	$V_{CM} = V_{CC}/2$	Differential	1000		$M\Omega$
			Common mode	1000		
Input Capacitance	$C_{IN}$	$V_{CM} = V_{CC}/2$	Differential	1		pF
			Common mode	4		
Input Voltage Range	$V_{IN}$	Inferred from CMR test	$V_{EE} - 0.2$		$V_{CC} - 1.1$	V
DC Common-Mode Rejection	$CMR_{DC}$	$V_{CM} = V_{EE} - 0.2V$ to $V_{CC} - 1.1V$ , $T_A = +25^\circ C$ , $\Delta R_S = 1k\Omega$ (Note 1)	$G = +1V$	66	78	dB
			$G = +10V$	80	94	
			$G = +100V$	86	99	
		$V_{CM} = V_{EE} - 0.2V$ to $V_{CC} - 1.1V$ , $T_A = T_{MIN}$ to $T_{MAX}$ , $\Delta R_S = 1k\Omega$ , (Note 1)	$G = +1V$	60	78	
			$G = +10V$	74	94	
			$G = +100V$	77	99	

## Electrical Characteristics (continued)

( $V_{CC} = +5V$ ,  $V_{EE} = 0V$ ,  $R_L = 25k\Omega$  tied to  $V_{CC}/2$ ,  $V_{REF} = V_{CC}/2$ ,  $T_A = T_{MIN}$  to  $T_{MAX}$ , unless otherwise noted. Typical values are at  $T_A = +25^\circ C$ .)

PARAMETER	SYMBOL	CONDITIONS		MIN	TYP	MAX	UNITS
DC Common-Mode Rejection	CMR <sub>DC</sub>	$V_{CM} = V_{EE} + 0.2V$ to $V_{CC} - 1.1V$ , $T_A = +25^\circ C$ , $\Delta R_S = 1k\Omega$	$G = +1V$	78	95	dB	
			$G = +10V$	93	115		
			$G = +100V/V$	95	115		
			$G = +1000V/V$		115		
		$V_{CM} = V_{EE} + 0.2V$ to $V_{CC} - 1.1V$ , $T_A = T_{MIN}$ to $T_{MAX}$ , $\Delta R_S = 1k\Omega$	$G = +1V$	73	95		
			$G = +10V$	88	115		
			$G = +100V/V$	90	115		
			$G = +1000V/V$		115		
AC Common-Mode Rejection	CMR <sub>AC</sub>	$V_{CM} = V_{EE} + 0.2V$ to $V_{CC} - 1.1V$ , $f = 120Hz$	$G = +1V$		85	dB	
			$G = +10V$		101		
			$G = +100V$		106		
Power-Supply Rejection	PSR	$+2.7V \leq V_{CC} \leq +7.5V$ ; $V_{CM} = +1.5V$ ; $V_{OUT} = +1.5V$ ; $V_{REF} = +1.5V$ ; $R_L = 25k\Omega$ to $+1.5V$ ; $G = +1V/V, +10V/V, +100V/V$	90	120		dB	
Input Bias Current	$I_B$	$V_{CM} = V_{CC}/2$		6	20	nA	
Input Bias Current Drift	$TC_{IB}$	$V_{CM} = V_{CC}/2$		15		$\mu A/^\circ C$	
Input Offset Current	$I_{OS}$	$V_{CM} = V_{CC}/2$		$\pm 1.0$	$\pm 3.0$	nA	
Input Offset Current Drift	$TC_{IOS}$	$V_{CM} = V_{CC}/2$		15		$\mu A/^\circ C$	
Input Noise Voltage	$e_n$	$G = +1V/V$	$f = 10Hz$		85	$nV/\sqrt{Hz}$	
			$f = 100Hz$		75		
			$f = 10kHz$		72		
			$f = 0.1Hz$ to $10Hz$		1.4		$\mu VRMS$
		$G = +10V/V$	$f = 10Hz$		35	$nV/\sqrt{Hz}$	
			$f = 100Hz$		32		
			$f = 10kHz$		31		
			$f = 0.1Hz$ to $10Hz$		0.7		$\mu VRMS$
		$G = +100V/V$	$f = 10Hz$		32	$nV/\sqrt{Hz}$	
			$f = 100Hz$		31		
			$f = 10kHz$		8.7		
			$f = 0.1Hz$ to $10Hz$		0.6		$\mu VRMS$
Input Noise Current	$i_n$	$f = 10Hz$		2.4	$pA/\sqrt{Hz}$		
		$f = 100Hz$		0.76			
		$f = 10kHz$		0.1			
		$f = 0.1Hz$ to $10Hz$		16		$pARMS$	
Output Voltage Swing	$V_{OH}, V_{OL}$	$R_L = 25k\Omega$ to $V_{CC}/2$	$V_{CC} - V_{OH}$		30	100	mV
			$V_{OL}$		30	100	
		$R_L = 5k\Omega$ to $V_{CC}/2$	$V_{CC} - V_{OH}$		100	200	
			$V_{OL}$		100	200	

## Electrical Characteristics (continued)

( $V_{CC} = +5V$ ,  $V_{EE} = 0V$ ,  $R_L = 25k\Omega$  tied to  $V_{CC}/2$ ,  $V_{REF} = V_{CC}/2$ ,  $T_A = T_{MIN}$  to  $T_{MAX}$ , unless otherwise noted. Typical values are at  $T_A = +25^\circ C$ .)

PARAMETER	SYMBOL	CONDITIONS		MIN	TYP	MAX	UNITS
Short-Circuit Current (Note 2)	$I_{SC}$				$\pm 4.5$		mA
Gain Equation		MAX4194 only			$1 +$ $(50k\Omega/R_G)$		
Gain Error		$T_A = +25^\circ C$ , $V_{CM} = V_{CC}/2$ , $R_L = 25k\Omega$ , $V_{EE} + 0.1V \leq V_{OUT}$ $\leq V_{CC} - 0.1V$	$G = +1V$		$\pm 0.01$	$\pm 0.1$	%
			$G = +10V$		$\pm 0.03$	$\pm 0.3$	
			$G = +100V/V$		$\pm 0.05$	$\pm 0.5$	
			$G = +1000V/V$ , MAX4194		$\pm 0.5$		
		$T_A = +25^\circ C$ , $V_{CM} = V_{CC}/2$ , $R_L = 5k\Omega$ , $V_{EE} + 0.2V \leq V_{OUT}$ $\leq V_{CC} - 0.2V$	$G = +1V$		$\pm 0.01$	$\pm 0.1$	
			$G = +10V$		$\pm 0.03$	$\pm 0.3$	
			$G = +100V/V$		$\pm 0.05$	$\pm 0.5$	
			$G = +1000V/V$ , MAX4194		$\pm 0.5$		
Gain Temperature Coefficient (Note 1)		MAX4194/MAX4195, $G = +1V/V$			$\pm 1$	$\pm 8$	ppm/ $^\circ C$
		MAX4196/MAX4197			$\pm 1$	$\pm 15$	
50k $\Omega$ Resistance Temperature Coefficient (Note 3)	$TC_{50k\Omega}$	MAX4194			$\pm 16$		ppm/ $^\circ C$
Nonlinearity		$V_{EE} + 0.1V \leq V_{OUT} \leq V_{CC} - 0.1V$ , $V_{CM} = V_{CC}/2$ , $G = +1V/V$ , $+10V/V$ , $+100V/V$ , $+1000V/V$			$\pm 0.001$		%
Capacitive-Load Stability	$C_L$				300		pF
-3dB Bandwidth	$BW_{-3dB}$	$V_{OUT} \leq 0.1V_{P-P}$ , $V_{CM} = V_{CC}/2$	$G = +1V/V$	MAX4194		250	kHz
				MAX4195		220	
			$G = +10V/V$	MAX4194		17	
				MAX4196		34	
			$G = +100V/V$	MAX4194		1.5	
				MAX4197		3.1	
$G = +1000V/V$	MAX4194		0.147				
Slew Rate	SR	$V_{OUT} = 2V_{P-P}$ , $G = +1V/V$			0.06		V/ $\mu s$
Settling Time	$t_s$	0.1%, $V_{OUT} = 2V_{P-P}$	$G = +1V/V$		0.05	ms	
			$G = +10V/V$		0.04		
			$G = +100V/V$		5		
			$G = +1000V/V$		7		
Total Harmonic Distortion	THD	$V_{OUT} = 2V_{P-P}$ , $G = +1V/V$ , $f = 1kHz$			0.001		%
Input Logic Voltage High	$V_{IH}$			$V_{CC} - 1.5$			V
Input Logic Voltage Low	$V_{IL}$				$V_{CC} - 2.5$		V
$\overline{SHDN}$ Input Current		$V_{EE} < \overline{V_{SHDN}} < V_{CC}$	MAX4195/MAX4196/ MAX4197 only		$\pm 0.1$		$\mu A$

**Electrical Characteristics (continued)**

( $V_{CC} = +5V$ ,  $V_{EE} = 0V$ ,  $R_L = 25k\Omega$  tied to  $V_{CC}/2$ ,  $V_{REF} = V_{CC}/2$ ,  $T_A = T_{MIN}$  to  $T_{MAX}$ , unless otherwise noted. Typical values are at  $T_A = +25^\circ C$ .)

PARAMETER	SYMBOL	CONDITIONS	MIN	TYP	MAX	UNITS
Time to Shutdown	$t_{SHDN}$	$G = +1V/V$ , 0.1%, $V_{OUT} = +3V$		0.5		ms
Enable Time From Shutdown	$t_{ENABLE}$	$G = +1V/V$ , 0.1%, $V_{OUT} = +3.5V$		0.5		ms
Power-Up Delay		$G = +1V/V$ , 0.1%, $V_{OUT} = +3.5V$		1		ms
On/Off Settling Time	$t_{ON/OFF}$	$V_{SHDN} = V_{CC} - 2.5V$ to $V_{CC} - 1.5V$ , $G = +100V/V$ , 0.1%, $V_{OUT} = +3.5V$		0.5		ms

**Note 1:** Guaranteed by design.

**Note 2:** Maximum output current (sinking/sourcing) in which the gain changes by less than 0.1%.

**Note 3:** This specification represents the typical temperature coefficient of an on-chip thin film resistor. In practice, the temperature coefficient of the gain for the MAX4194 will be dominated by the temperature coefficient of the external gain-setting resistor.

**Typical Operating Characteristics**

( $V_{CC} = +5V$ ,  $V_{EE} = 0$ ,  $R_L = 25k\Omega$  tied to  $V_{CC}/2$ ,  $T_A = +25^\circ C$ , unless otherwise noted.)



Typical Operating Characteristics (continued)

( $V_{CC} = +5V$ ,  $V_{EE} = 0$ ,  $R_L = 25k\Omega$  tied to  $V_{CC}/2$ ,  $T_A = +25^\circ C$ , unless otherwise noted.)

**MAX4194  
LARGE-SIGNAL PULSE RESPONSE  
(GAIN = +1V/V)**

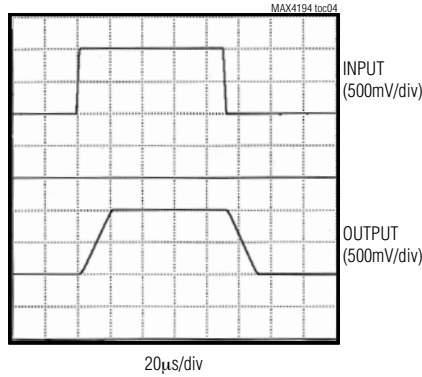

**MAX4194  
LARGE-SIGNAL PULSE RESPONSE  
(GAIN = +100V/V)**



**MAX4197  
LARGE-SIGNAL PULSE RESPONSE  
(GAIN = +100V/V)**

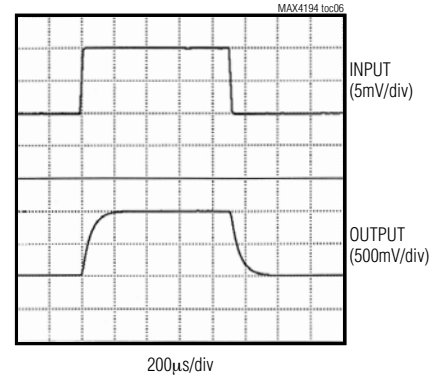

**MAX4194  
SMALL-SIGNAL PULSE RESPONSE  
(GAIN = +1V/V)**

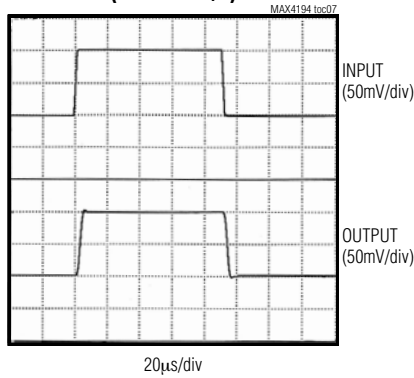

**MAX4194  
SMALL-SIGNAL PULSE RESPONSE  
(GAIN = +100V/V)**



**MAX4197  
SMALL-SIGNAL PULSE RESPONSE  
(GAIN = +100V/V)**

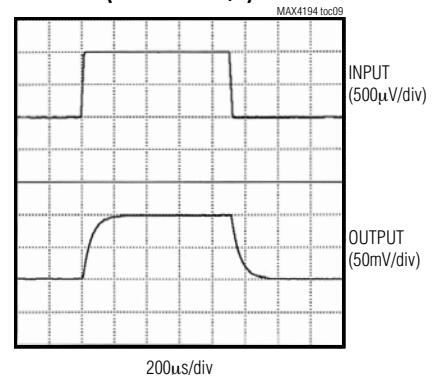

**POWER-SUPPLY REJECTION  
vs. FREQUENCY**

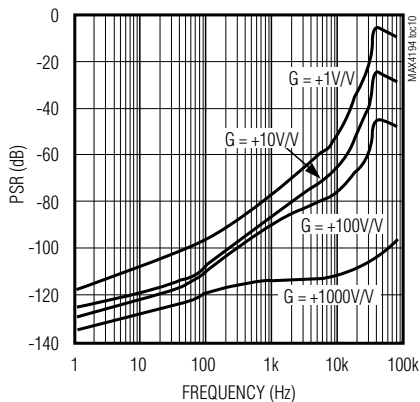

**COMMON-MODE REJECTION  
vs. FREQUENCY**

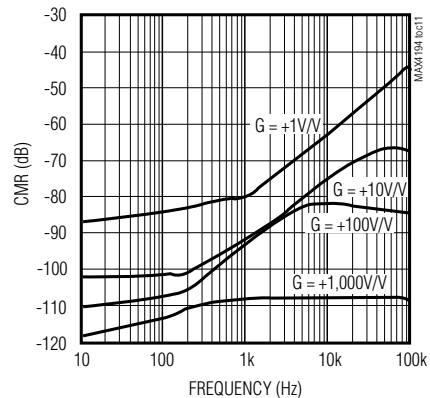

Typical Operating Characteristics (continued)

( $V_{CC} = +5V$ ,  $V_{EE} = 0$ ,  $R_L = 25k\Omega$  tied to  $V_{CC}/2$ ,  $T_A = +25^\circ C$ , unless otherwise noted.)

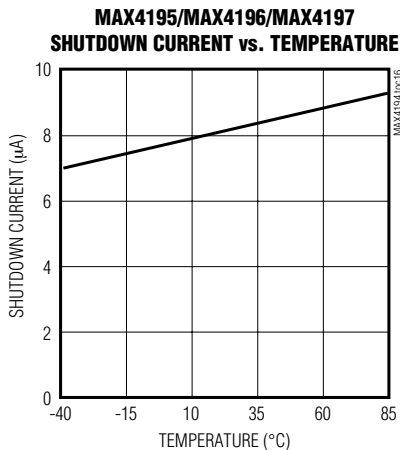
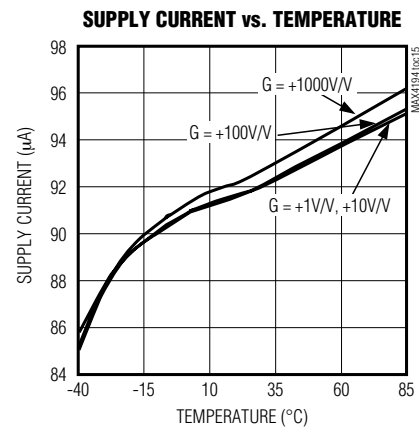
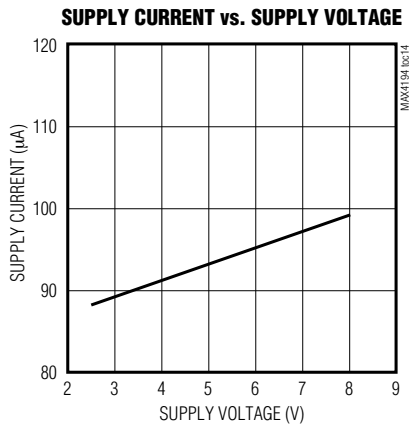
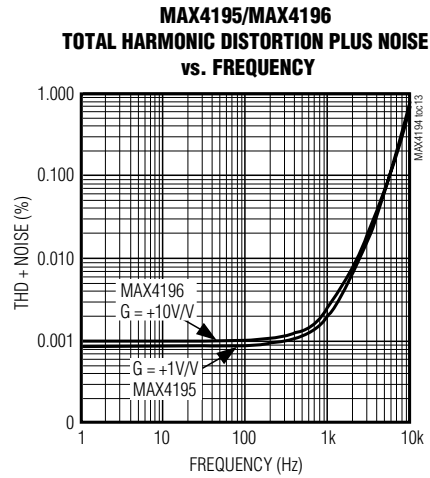
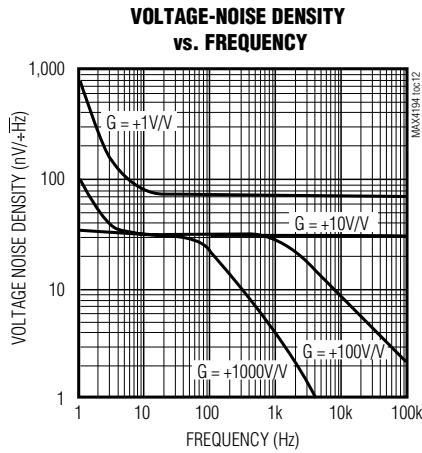

Typical Operating Characteristics (continued)

( $V_{CC} = +5V$ ,  $V_{EE} = 0$ ,  $R_L = 25k\Omega$  tied to  $V_{CC}/2$ ,  $T_A = +25^\circ C$ , unless otherwise noted.)

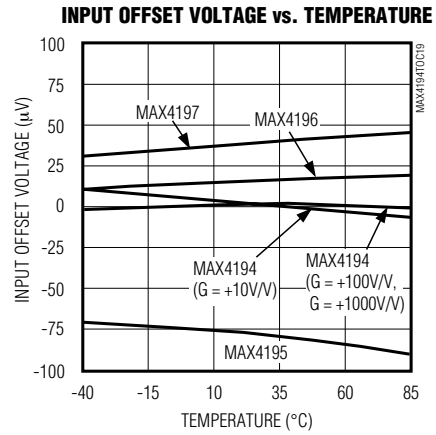
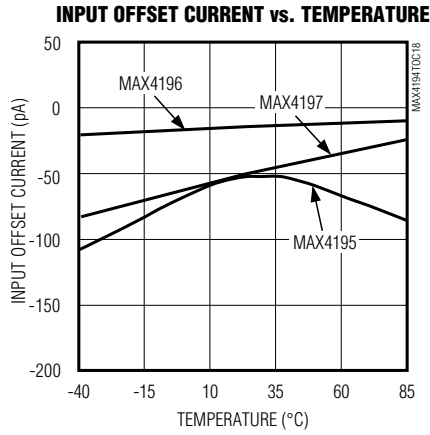

Pin Description

PIN		NAME	FUNCTION
MAX4194	MAX4195 MAX4196 MAX4197		
1, 8	—	RG-, RG+	Connection for Gain-Setting Resistor
5	1	REF	Reference Voltage. Offsets output voltage.
2	2	IN-	Inverting Input
3	3	IN+	Noninverting Input
4	4	V <sub>EE</sub>	Negative Supply Voltage
—	5	FB	Feedback. Connects to OUT.
6	6	OUT	Amplifier Output
7	7	V <sub>CC</sub>	Positive Supply Voltage
—	8	$\overline{SHDN}$	Shutdown Control



Detailed Description

Input Stage

The MAX4194–MAX4197 family of low-power instrumentation amplifiers implements a three-amplifier topology (Figure 1). The input stage is composed of two operational amplifiers that together provide a fixed-gain differential and a unity common-mode gain. The output stage is a conventional differential amplifier that provides an overall common-mode rejection of 115dB ( $G =$

$+10V/V$ ). The MAX4194’s gain can be externally set between  $+1V/V$  and  $+10,000V/V$  (Table 1). The MAX4195/MAX4196/MAX4197 have on-chip gain-setting resistors (Figure 2), and their gains are fixed at  $+1V/V$ ,  $+10V/V$ , and  $+100V/V$ , respectively.

Input Voltage Range and Detailed Operation

The common-mode input range for all of these amplifiers is  $V_{EE} - 0.2V$  to  $V_{CC} - 1.1V$ . Ideally, the instrumentation amplifier (Figure 3) responds only to a differential voltage applied to its inputs,  $IN+$  and  $IN-$ . If both inputs are at the same voltage, the output is  $V_{REF}$ . A differential voltage at  $IN+$  ( $V_{IN+}$ ) and  $IN-$  ( $V_{IN-}$ ) develops an identical voltage across the gain-setting resistor, causing a current ( $I_G$ ) to flow. This current also flows through the feedback resistors of the two input amplifiers A1 and A2, generating a differential voltage of:

$$V_{OUT2} - V_{OUT1} = I_G \cdot (R_1 + R_G + R_1)$$

where  $V_{OUT1}$  and  $V_{OUT2}$  are the output voltages of A1 and A2,  $R_G$  is the gain-setting resistor (internal or external to the part), and  $R_1$  is the feedback resistor of the input amplifiers.

$I_G$  is determined by the following equation:

$$I_G = (V_{IN+} - V_{IN-}) / R_G$$

The output voltage ( $V_{OUT}$ ) for the instrumentation amplifier is expressed in the following equation:

$$V_{OUT} = (V_{IN+} - V_{IN-}) \cdot [(2 \cdot R_1) / R_G] + 1$$

The common-mode input range is a function of the amplifier’s output voltage and the supply voltage. With a power supply of  $V_{CC}$ , the largest output signal swing can be obtained with  $REF$  tied to  $V_{CC}/2$ . This results in an output voltage swing of  $\pm V_{CC}/2$ . An output voltage swing less than full-scale increases the common-mode input range.



Figure 1. MAX4194 Simplified Block Diagram



Figure 2. MAX4195/MAX4196/MAX4197 Simplified Block Diagram



Figure 3. Instrumentation Amplifier Configuration

\*  $R_1 = R_2 = 25k\Omega$   
\*\*  $R_G =$  INTERNAL TO MAX4195/MAX4196/MAX4197  
 $R_G =$  EXTERNAL TO MAX4194

**Table 1. MAX4194 External Gain Resistor Selection**

GAIN (V/V)	CLOSEST R <sub>G</sub> (1%) (Ω)	CLOSEST R <sub>G</sub> (5%) (Ω)
+1	∞ *	∞ *
+2	49.9k	51k
+5	12.4k	12k
+10	5.62k	5.6k
+20	2.61k	2.7k
+50	1.02k	1.0k
+100	511	510
+200	249	240
+500	100	100
+1,000	49.9	51
+2,000	24.9	24
+5,000	10	10
+10,000	4.99	5.1

\*Leave pins 1 and 8 open for  $G = +1V/V$ .

**V<sub>CM</sub> vs. V<sub>OUT</sub> Characterization**

Figure 4 illustrates the MAX4194 typical common-mode input voltage range over output voltage swing at unity-gain (pins 1 and 8 left floating), with a single-supply voltage of  $V_{CC} = +5V$  and a bias reference voltage of  $V_{REF} = V_{CC}/2 = +2.5V$ . Points A and D show the full input voltage range of the input amplifiers ( $V_{EE} - 0.2V$  to  $V_{CC} - 1.1V$ ) since, with  $+2.5V$  output, there is zero input differential swing. The other points (B, C, E, and F) are determined by the input voltage range of the input amps minus the differential input amplitude necessary to produce the associated  $V_{OUT}$ . For the higher gain configurations, the  $V_{CM}$  range will increase at the endpoints (B, C, E, and F) since a smaller differential voltage is necessary for the given output voltage.

**Rail-to-Rail Output Stage**

The MAX4194–MAX4197’s output stage incorporates a common-source structure that maximizes the dynamic range of the instrumentation amplifier.

The output can drive up to a  $25k\Omega$  (tied to  $V_{CC}/2$ ) resistive load and still typically swing within 30mV of the rails. With an output load of  $5k\Omega$  tied to  $V_{CC}/2$ , the output voltage swings within 100mV of the rails.

**Shutdown Mode**

The MAX4195–MAX4197 feature a low-power shutdown mode. When the shutdown pin (SHDN) is pulled low, the internal amplifiers are switched off and the supply current drops to 8μA typically (Figures 5a, 5b, and 5c).

This disables the instrumentation amplifier and puts its output in a high-impedance state. Pulling  $\overline{SHDN}$  high enables the instrumentation amplifier.

**Applications Information**

**Setting the Gain (MAX4194)**

The MAX4194’s gain is set by connecting a single, external gain resistor between the two R<sub>G</sub> pins (pin 1 and pin 8), and can be described as:

$$G = 1 + 50k\Omega / R_G$$

where G is the instrumentation amplifier’s gain and R<sub>G</sub> is the gain-setting resistor.

The  $50k\Omega$  resistor of the gain equation is the sum of the two resistors internally connected to the feedback loops of the IN+ and IN- amplifiers. These embedded feedback resistors are laser trimmed, and their accuracy and temperature coefficients are included in the gain and drift specification for the MAX4194.

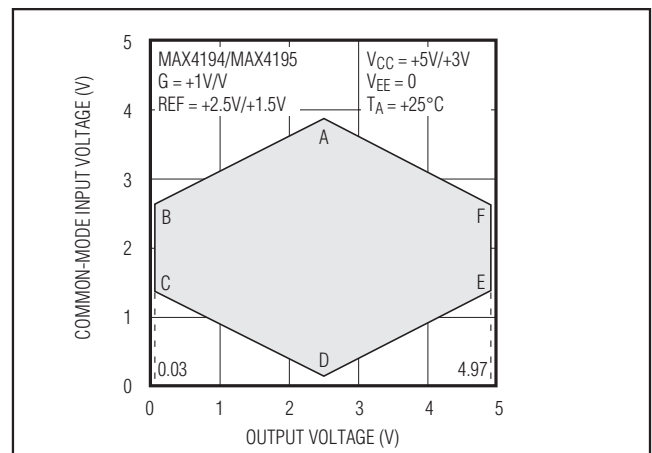

Figure 4. Common-Mode Input Voltage vs. Output Voltage

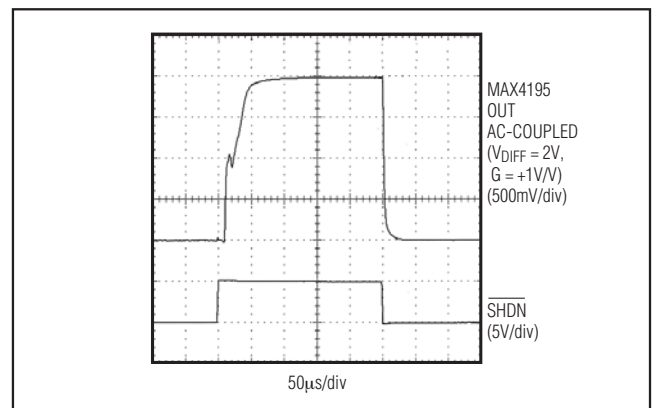

Figure 5a. MAX4195 Shutdown Mode



Figure 5b. MAX4196 Shutdown Mode



Figure 5c. MAX4197 Shutdown Mode

The accuracy and temperature drift of the  $R_G$  resistors also influence the IC's precision and gain drift, and can be derived from the equation above. With low  $R_G$  values, which are required for high-gain operation, parasitic resistances may significantly increase the gain error.

### Capacitive-Load Stability

The MAX4194–MAX4197 are stable for capacitive loads up to 300pF (Figure 6a). Applications that require greater capacitive-load driving capability can use an isolation resistor (Figure 6b) between the output and the capacitive load to reduce ringing on the output signal. However, this alternative reduces gain accuracy because  $R_{ISO}$  (Figure 6c) forms a potential divider with the load resistor.



Figure 6a. Using a Resistor to Isolate a Capacitive Load from the Instrumentation Amplifier ( $G = +1V/V$ )

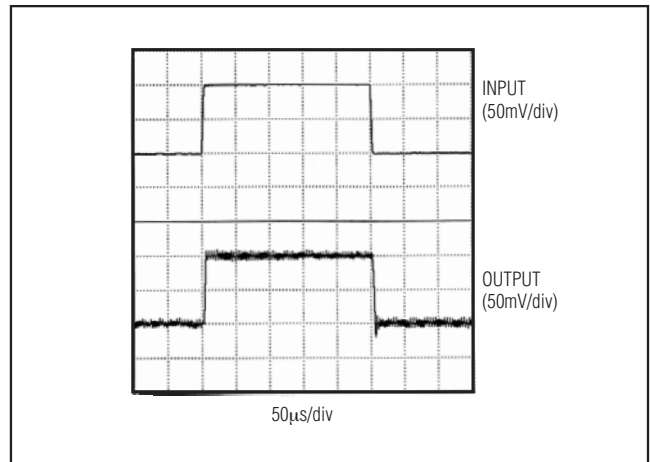

Figure 6b. Small-Signal Pulse Response with Excessive Capacitive Load ( $R_L = 25k\Omega$ ,  $C_L = 1000pF$ )



Figure 6c. Small-Signal Pulse Response with Excessive Capacitive Load and Isolating Resistor ( $R_{ISO} = 75\Omega$ ,  $R_L = 25k\Omega$ ,  $C_L = 1000pF$ )

**Power-Supply Bypassing and Layout**

Good layout technique optimizes performance by decreasing the amount of stray capacitance at the instrumentation amplifier’s gain-setting pins. Excess capacitance will produce peaking in the amplifier’s frequency response. To decrease stray capacitance, minimize trace lengths by placing external components as close to the instrumentation amplifier as possible. For best performance, bypass each power supply to ground with a separate 0.1µF capacitor.

**Transducer Applications**

The MAX4194–MAX4197 instrumentation amplifiers can be used in various signal-conditioning circuits for thermocouples, PT100s, strain gauges (displacement sensors), piezoresistive transducers (PRTs), flow sensors, and bioelectrical applications. Figure 7 shows a simplified example of how to attach four strain gauges (two

identical two-element strain gauges) to the inputs of the MAX4194. The bridge contains four resistors, two of which increase and two of which decrease by the same ratio.

With a fully balanced bridge, points A (IN+) and B (IN-) see half the excitation voltage (V<sub>BRIDGE</sub>). The low impedance (120Ω to 350Ω) of the strain gauges, however, could cause significant voltage drop contributions by the wires leading to the bridge, which would cause excitation variations. Output voltage V<sub>OUT</sub> can be calculated as follows:

$$V_{OUT} = V_{AB} \cdot G$$

where  $G = (1 + 50k\Omega / R_G)$  is the gain of the instrumentation amplifier.

Since V<sub>AB</sub> is directly proportional to the excitation, gain errors may occur.

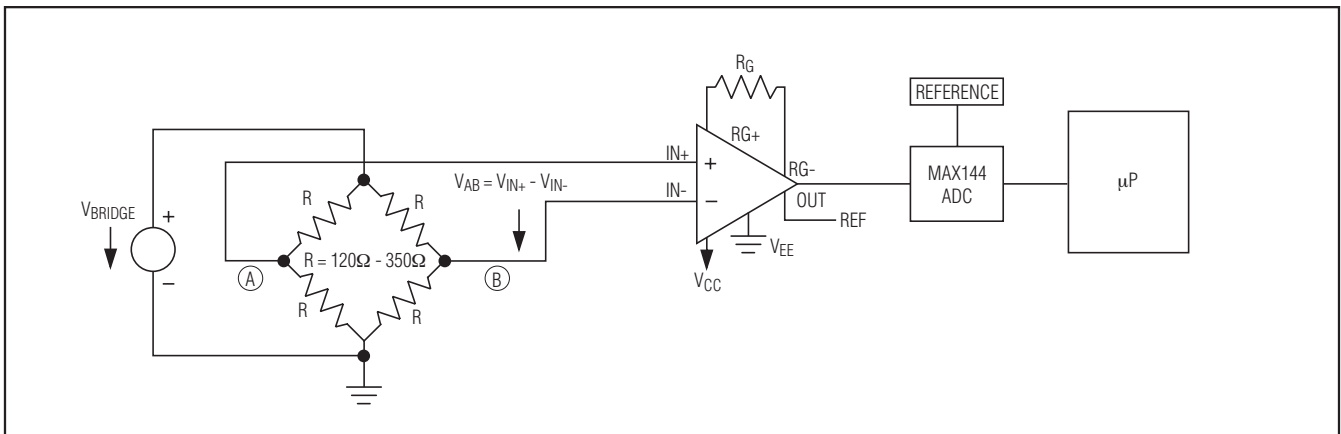

Figure 7. Strain Gauge Connection to the MAX4194

**Chip Information**

TRANSISTOR COUNT: 432

**Package Information**

For the latest package outline information and land patterns (footprints), go to [www.maximintegrated.com/packages](http://www.maximintegrated.com/packages). Note that a “+”, “#”, or “-” in the package code indicates RoHS status only. Package drawings may show a different suffix character, but the drawing pertains to the package regardless of RoHS status.

PACKAGE TYPE	PACKAGE CODE	OUTLINE NO.	LAND PATTERN NO.
8 SO	S8-5	<a href="#">21-0041</a>	<a href="#">90-0096</a>

## Revision History

REVISION NUMBER	REVISION DATE	DESCRIPTION	PAGES CHANGED
2	5/15	Updated <i>Benefits and Features</i> section	1

For pricing, delivery, and ordering information, please contact Maxim Direct at 1-888-629-4642, or visit Maxim Integrated's website at [www.maximintegrated.com](http://www.maximintegrated.com).

*Maxim Integrated cannot assume responsibility for use of any circuitry other than circuitry entirely embodied in a Maxim Integrated product. No circuit patent licenses are implied. Maxim Integrated reserves the right to change the circuitry and specifications without notice at any time. The parametric values (min and max limits) shown in the Electrical Characteristics table are guaranteed. Other parametric values quoted in this data sheet are provided for guidance.*

Компания «Life Electronics» занимается поставками электронных компонентов импортного и отечественного производства от производителей и со складов крупных дистрибьюторов Европы, Америки и Азии.

С конца 2013 года компания активно расширяет линейку поставок компонентов по направлению коаксиальный кабель, кварцевые генераторы и конденсаторы (керамические, пленочные, электролитические), за счёт заключения дистрибьюторских договоров

Мы предлагаем:

- Конкурентоспособные цены и скидки постоянным клиентам.
- Специальные условия для постоянных клиентов.
- Подбор аналогов.
- Поставку компонентов в любых объемах, удовлетворяющих вашим потребностям.
- Приемлемые сроки поставки, возможна ускоренная поставка.
- Доставку товара в любую точку России и стран СНГ.
- Комплексную поставку.
- Работу по проектам и поставку образцов.
- Формирование склада под заказчика.
- Сертификаты соответствия на поставляемую продукцию (по желанию клиента).
- Тестирование поставляемой продукции.
- Поставку компонентов, требующих военную и космическую приемку.
- Входной контроль качества.
- Наличие сертификата ISO.

В составе нашей компании организован Конструкторский отдел, призванный помогать разработчикам, и инженерам.

Конструкторский отдел помогает осуществить:

- Регистрацию проекта у производителя компонентов.
- Техническую поддержку проекта.
- Защиту от снятия компонента с производства.
- Оценку стоимости проекта по компонентам.
- Изготовление тестовой платы монтаж и пусконаладочные работы.



Тел: +7 (812) 336 43 04 (многоканальный)

Email: [org@lifeelectronics.ru](mailto:org@lifeelectronics.ru)