

FEATURES

- Allows Safe Board Insertion and Removal from a Live -48V Backplane
- Floating Topology Permits Very High Voltage Operation
- Adjustable Analog Current Limit with Breaker Timer Ideal for Two Battery Feeds
- Fast Response Time Limits Peak Fault Current
- Adjustable Undervoltage/Overvoltage Protection with $\pm 1\%$ Threshold Accuracy (LTC4253A)
- Three Sequenced Power Good Outputs
- Adjustable Soft-Start Current Limit
- Adjustable Timer with Drain Voltage Accelerated Response
- Latchoff After Fault
- Available in a 16-Pin SSOP Package

APPLICATIONS

- -48V Distributed Power Systems
- Negative Power Supply Control
- Central Office Switching
- High Availability Servers
- Disk Arrays

LT, LT, LTC, LTM, Linear Technology and the Linear logo are registered trademarks and Hot Swap is a trademark of Linear Technology Corporation. All other trademarks are the property of their respective owners.

DESCRIPTION

The **LTC[®]4253/LTC4253A** negative voltage Hot Swap™ controllers allow a board to be safely inserted and removed from a live backplane. Output current is controlled by three stages of current-limiting: a timed circuit breaker, active current limiting and a fast feedforward path that limits peak current under worst-case catastrophic fault conditions. The LTC4253/LTC4253A latch off after a circuit fault.

Adjustable undervoltage and overvoltage detectors disconnect the load whenever the input supply exceeds the desired operating range. The LTC4253/LTC4253A's supply input is shunt-regulated, allowing safe operation with very high supply voltages. A multifunction timer delays initial start-up and controls the circuit breaker's response time. The circuit breaker's response time can be accelerated by sensing excessive MOSFET drain voltage, keeping the MOSFET within its safe operating area (SOA). An adjustable soft-start circuit controls MOSFET inrush current at start-up.

Three power good outputs are sequenced by an adjustable timer and two ENABLE inputs to enable external power modules at start-up or disable them if the circuit breaker trips. The LTC4253A features tight $\pm 1\%$ undervoltage/overvoltage threshold accuracy. The LTC4253/LTC4253A are available in a 16-pin SSOP.

TYPICAL APPLICATION

-48V/2.5A Hot Swap Controller

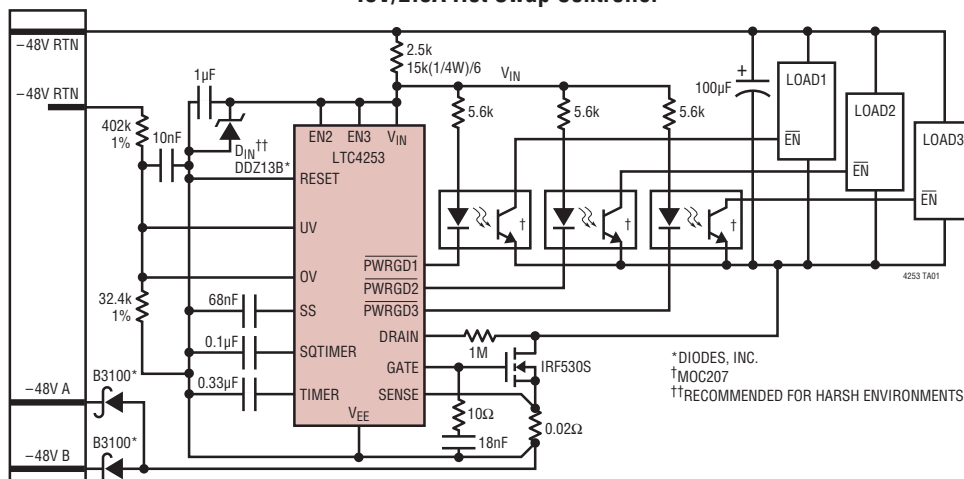

Start-Up Behavior

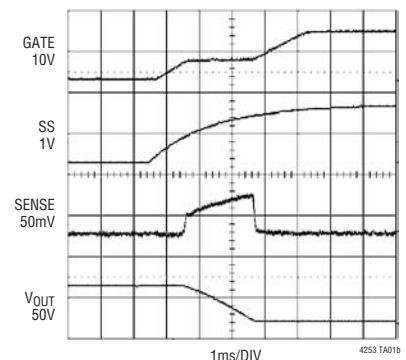

425353aff

LTC4253/LTC4253A

ABSOLUTE MAXIMUM RATINGS

(Note 1), All voltages referred to V_{EE}

Current into V_{IN} (100 μ s Pulse)	100mA
Current into DRAIN (100 μ s Pulse)	20mA
V_{IN} , DRAIN Minimum Voltage	-0.3V
Input/Output (Except SENSE and DRAIN) Voltage	-0.3V to 16V
SENSE Voltage	-0.6V to 16V
Current Out of SENSE (20 μ s Pulse)	-200mA
Maximum Junction Temperature	125°C
Operating Temperature Range	
LTC4253C	0°C to 70°C
LTC4253I	-40°C to 85°C
LTC4253AC (OBSOLETE)	0°C to 70°C
LTC4253AI (OBSOLETE)	-40°C to 85°C
Storage Temperature Range	-65°C to 150°C
Lead Temperature (Soldering, 10 sec)	300°C

PIN CONFIGURATION

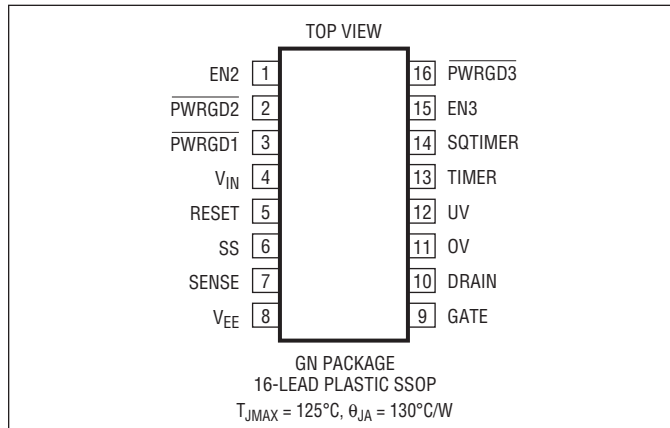

ORDER INFORMATION

LEAD FREE FINISH	TAPE AND REEL	PART MARKING	PACKAGE DESCRIPTION	TEMPERATURE RANGE
LTC4253CGN#PBF	LTC4253CGN#TRPBF	4253	16-Lead Plastic SSOP	0°C to 70°C
LTC4253IGN#PBF	LTC4253IGN#TRPBF	4253I	16-Lead Plastic SSOP	-40°C to 85°C
OBSOLETE PACKAGE				
LTC4253ACGN#PBF	LTC4253ACGN#TRPBF	4253A	16-Lead Plastic SSOP	0°C to 70°C
LTC4253AIGN#PBF	LTC4253AIGN#TRPBF	4253AI	16-Lead Plastic SSOP	-40°C to 85°C

Consult LTC Marketing for parts specified with wider operating temperature ranges.

Consult LTC Marketing for information on non-standard lead based finish parts.

For more information on lead free part marking, go to: <http://www.linear.com/leadfree/>

For more information on tape and reel specifications, go to: <http://www.linear.com/tapeandreel/>

ELECTRICAL CHARACTERISTICS

The ● denotes the specifications which apply over the full operating temperature range, otherwise specifications are at $T_A = 25^\circ\text{C}$. (Note 2)

SYMBOL	PARAMETER	CONDITIONS	LTC4253			LTC4253A			UNITS	
			MIN	TYP	MAX	MIN	TYP	MAX		
V_Z	$V_{IN} - V_{EE}$ Zener Voltage	$I_{IN} = 2\text{mA}$	● 11.5	13	14.5	11.5	13	14.5	V	
R_Z	$V_{IN} - V_{EE}$ Zener Dynamic Impedance	$I_{IN} = (2\text{mA to } 30\text{mA})$		5		5			Ω	
I_{IN}	V_{IN} Supply Current	$UV = OV = 4V, V_{IN} = (V_Z - 0.3V)$	●	0.8	2	1.1	2		mA	
V_{LKO}	V_{IN} Undervoltage Lockout	Coming Out of UVLO (Rising V_{IN})	●	9.2	11.5	9	10		V	
V_{LKH}	V_{IN} Undervoltage Lockout Hysteresis		●	0.5	1	1.5	0.25	0.5	0.75	V
V_{IH}	TTL Input High Voltage		●	2		2			V	
V_{IL}	TTL Input Low Voltage		●		0.8		0.8		V	
V_{HYST}	TTL Input Buffer Hysteresis			600		600			mV	
I_{RESET}	RESET Input Current	$V_{EE} \leq V_{RESET} \leq V_{IN}$	●	± 0.1	± 10	± 0.1	± 10		μA	
I_{EN}	EN2, EN3 Input Current	$V_{EN} = 4V, V_{EN} = 0V$	●	60	120	180	60	120	180	μA
			●	± 0.1	± 10	± 10	± 0.1	± 10	μA	
V_{CB}	Circuit Breaker Current Limit Voltage	$V_{CB} = (V_{SENSE} - V_{EE})$	●	40	50	60	45	50	55	mV
V_{ACL}	Analog Current Limit Voltage	$V_{ACL} = (V_{SENSE} - V_{EE}), SS = \text{Open or } 2.2V$	●	80	100	120				mV
$\frac{V_{ACL}}{V_{CB}}$	$\frac{\text{Analog Current Limit Voltage}}{\text{Circuit Breaker Current Limit Voltage}}$	$V_{ACL} = (V_{SENSE} - V_{EE}), SS = \text{Open or } 1.4V$	●				1.05	1.20	1.38	V/V
V_{FCL}	Fast Current Limit Voltage	$V_{FCL} = (V_{SENSE} - V_{EE})$	●	150	200	300	150	200	300	mV
V_{SS}	SS Voltage	After End of SS Timing Cycle	●	2	2.2	2.4	1.25	1.4	1.55	V
I_{SS}	SS Pin Current	$UV = OV = 4V, V_{SENSE} = V_{EE}, V_{SS} = 0V$ (Sourcing)	●	12	22	32	16	28	40	μA
		$UV = OV = 0V, V_{SENSE} = V_{EE}, V_{SS} = 1V$ (Sinking)			28		28			mA
R_{SS}	SS Output Impedance			100		50			$\text{k}\Omega$	
V_{OS}	Analog Current Limit Offset Voltage			10		10			mV	
$\frac{V_{ACL} + V_{OS}}{V_{SS}}$	Ratio ($V_{ACL} + V_{OS}$) to SS Voltage			0.05		0.05			V/V	
I_{GATE}	GATE Pin Output Current	$UV = OV = 4V, V_{SENSE} = V_{EE}, V_{GATE} = 0V$ (Sourcing)	●	30	50	70	30	50	70	μA
		$UV = OV = 4V, V_{SENSE} - V_{EE} = 0.15V, V_{GATE} = 3V$ (Sinking)			17		17			mA
		$UV = OV = 4V, V_{SENSE} - V_{EE} = 0.3V, V_{GATE} = 1V$ (Sinking)			190		190			mA
V_{GATE}	External MOSFET Gate Drive	$V_{GATE} - V_{EE}, I_{IN} = 2\text{mA}$	●	10	12	V_Z	10	12	V_Z	V
V_{GATEL}	Gate Low Threshold	Before Gate Ramp Up		0.5		0.5				V
V_{GATEH}	Gate High Threshold	$V_{GATEH} = V_{IN} - V_{GATE}$, for PWRGD1, PWRGD2, PWRGD3 Status		2.8		2.8				V
V_{UVHI}	UV Pin Threshold HIGH	UV Low to High	●	3.075	3.225	3.375				V
V_{UVLO}	UV Pin Threshold LOW	UV High to Low	●	2.775	2.925	3.075				V
V_{UV}	UV Pin Threshold	UV Low to High	●				3.05	3.08	3.11	V
V_{UVHST}	UV Pin Hysteresis		●	230	300	350	292	324	356	mV
										mV
V_{OVHI}	OV Pin Threshold HIGH	OV Low to High	●	5.85	6.15	6.45				V
V_{OVL0}	OV Pin Threshold LOW	OV High to Low	●	5.55	5.85	6.15				V

LTC4253/LTC4253A

ELECTRICAL CHARACTERISTICS

The ● denotes the specifications which apply over the full operating temperature range, otherwise specifications are at $T_A = 25^\circ\text{C}$.

SYMBOL	PARAMETER	CONDITIONS	LTC4253			LTC4253A			UNITS	
			MIN	TYP	MAX	MIN	TYP	MAX		
V_{OV}	OV Pin Threshold	OV Low to High	●				5.04	5.09	5.14	V
V_{OVHST}	OV Pin Hysteresis		●	230	300	350	82	102	122	mV mV
I_{SENSE}	SENSE Pin Input Current	UV = OV = 4V, $V_{SENSE} = 50\text{mV}$ (Sourcing)	●		15	30		15	30	μA
I_{INP}	UV, OV Pin Input Current	UV = OV = 4V	●		± 0.1	± 1		± 0.1	± 1	μA
V_{TMRH}	TIMER Pin Voltage High Threshold		●	3.5	4	4.5	3.5	4	4.5	V
V_{TMRL}	TIMER Pin Voltage Low Threshold		●	0.8	1	1.2	0.8	1	1.2	V
I_{TMR}	TIMER Pin Current	Timer On (Initial Cycle/Latchoff, Sourcing), $V_{TMR} = 2\text{V}$	●	3	5	7	3	5	7	μA
		Timer Off (Initial Cycle, Sinking), $V_{TMR} = 2\text{V}$			28		28			mA
		Timer On (Circuit Breaker, Sourcing, $I_{DRN} = 0\mu\text{A}$), $V_{TMR} = 2\text{V}$	●	120	200	280	120	200	280	μA
		Timer On (Circuit Breaker, Sourcing, $I_{DRN} = 50\mu\text{A}$), $V_{TMR} = 2\text{V}$			600		600			μA
		Timer Off (Circuit Breaker, Sinking), $V_{TMR} = 2\text{V}$	●	3	5	7	3	5	7	μA
$\frac{\Delta I_{TMRACC}}{\Delta I_{DRN}}$	I_{TMR} at $I_{DRN} = 50\mu\text{A}$ – I_{TMR} at $I_{DRN} = 0\mu\text{A}$ 50 μA	Timer On (Circuit Breaker with $I_{DRN} = 50\mu\text{A}$)	●	7	8	9	7	8	9	$\mu\text{A}/\mu\text{A}$
V_{SQTMRH}	SQTIMER Pin Voltage High Threshold		●	3.5	4	4.5	3.5	4	4.5	V
V_{SQTMRL}	SQTIMER Pin Voltage Low Threshold				0.33			0.33		V
I_{SQTMR}	SQTIMER Pin Current	SQTIMER On (Power Good Sequence, Sourcing), $V_{SQTMR} = 2\text{V}$	●	3	5	7	3	5	7	μA
		SQTIMER Off (Power Good Sequence, Sinking), $V_{SQTMR} = 2\text{V}$			28		28			mA
V_{DRNL}	DRAIN Pin Voltage Low Threshold	For PWRGD1, PWRGD2, PWRGD3 Status	●	2	2.39	3	2	2.39	3	V
I_{DRNL}	DRAIN Leakage Current	$V_{DRAIN} = 5\text{V}$ $V_{DRAIN} = 4\text{V}$			± 0.1	± 1		± 0.1	± 1	μA μA
V_{DRNCL}	DRAIN Pin Clamp Voltage	$I_{DRN} = 50\mu\text{A}$	●	6	7	8.5	5	6	7.5	V
V_{PGL}	PWRGD1, PWRGD2, PWRGD3 Output Low Voltage	$I_{PG} = 1.6\text{mA}$	●		0.25	0.4		0.25	0.4	V
		$I_{PG} = 5\text{mA}$	●			1.2			1.2	V
I_{PGH}	PWRGD1, PWRGD2, PWRGD3 Output High Current	$V_{PG} = 0\text{V}$ (Sourcing)	●	30	50	70	30	50	70	μA
t_{SQ}	SQTIMER Default Ramp Period	SQTIMER Pin Floating, V_{SQTMR} Ramps from 0.5V to 3.5V			250			250		μs
t_{SS}	SS Default Ramp Period	SS Pin Floating, V_{SS} Ramps from 0.2V to 2V			250					μs
		SS Pin Floating, V_{SS} Ramps from 0.2V to 1.25V						140		μs
t_{PLLUG}	UV Low to GATE Low		●		0.4	5		0.4	5	μs
t_{PHLOG}	OV High to GATE Low		●		0.4	5		0.4	5	μs

Note 1: Stresses beyond those listed under Absolute Maximum Ratings may cause permanent damage to the device. Exposure to any Absolute Maximum Rating condition for extended periods may affect device reliability and lifetime.

Note 2: All currents into device pins are positive; all currents out of device pins are negative. All voltages are referenced to V_{EE} unless otherwise specified.

TYPICAL PERFORMANCE CHARACTERISTICS

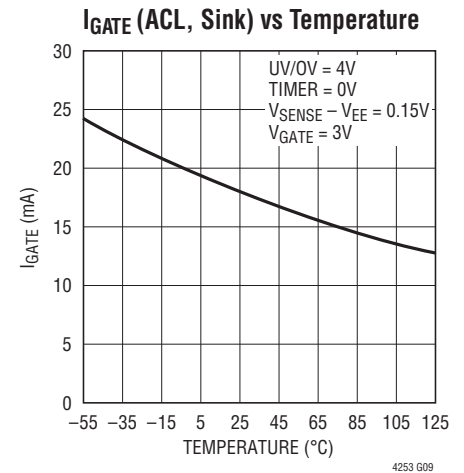
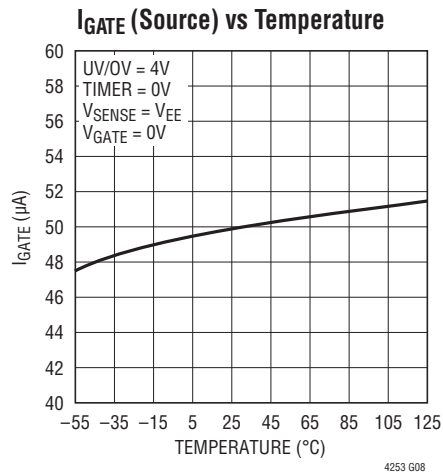
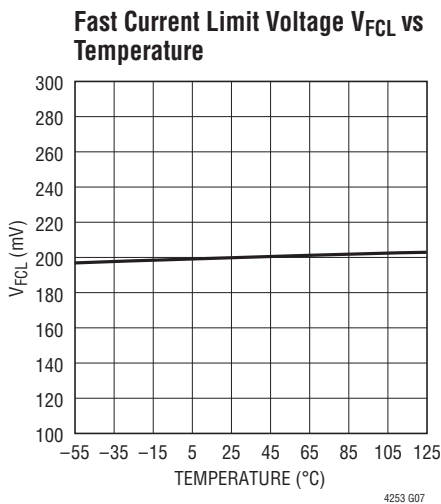
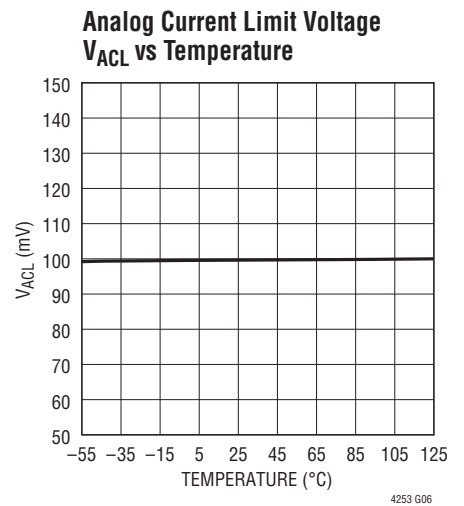
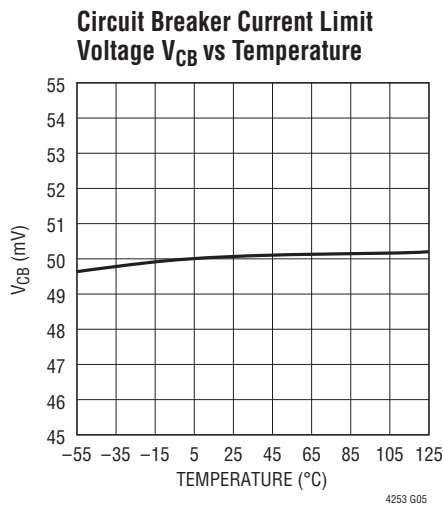
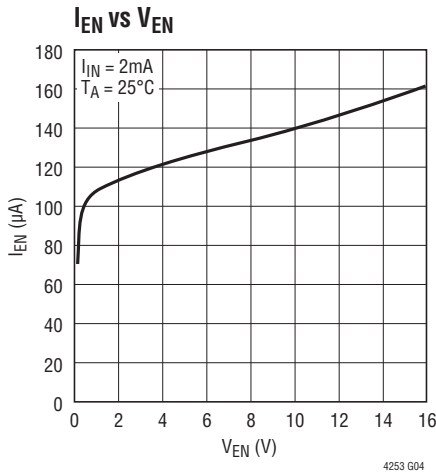
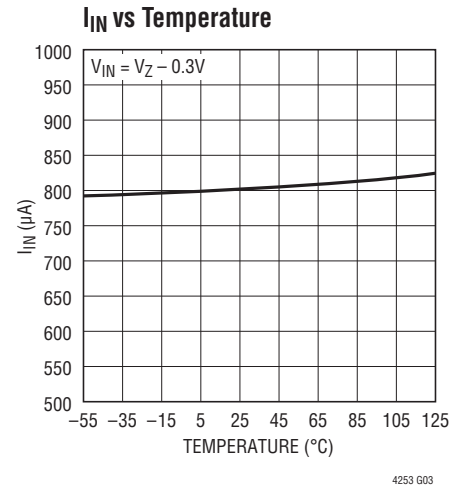
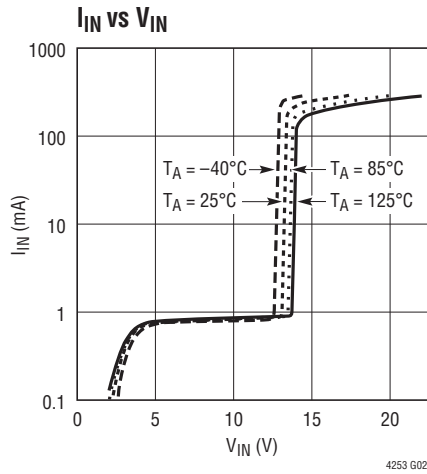
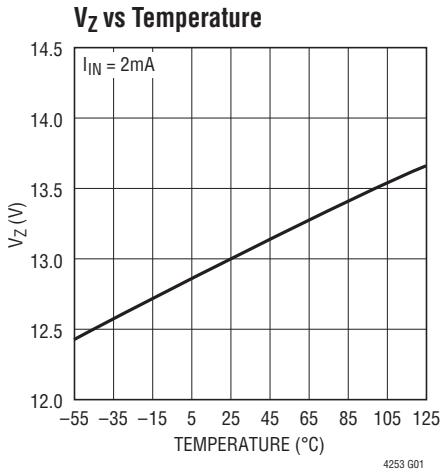

TYPICAL PERFORMANCE CHARACTERISTICS

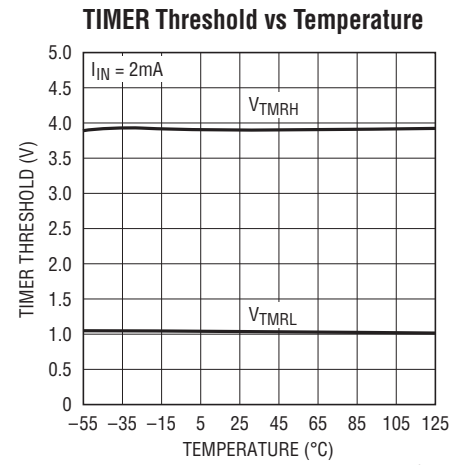
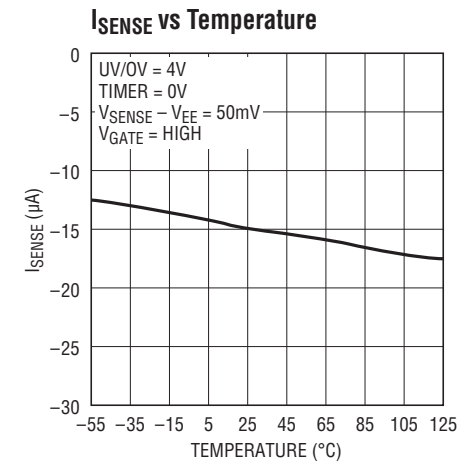
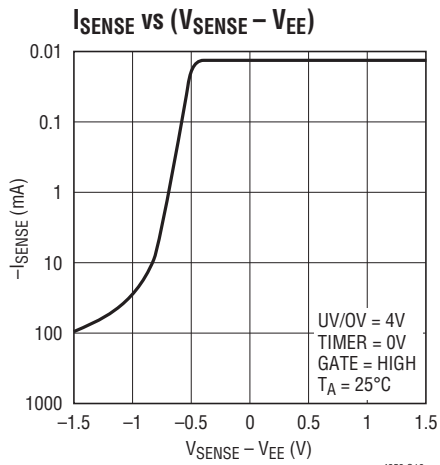
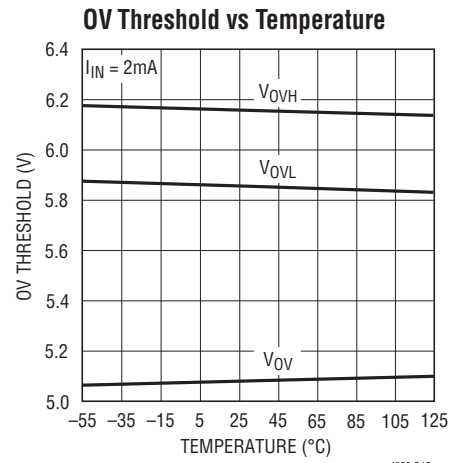
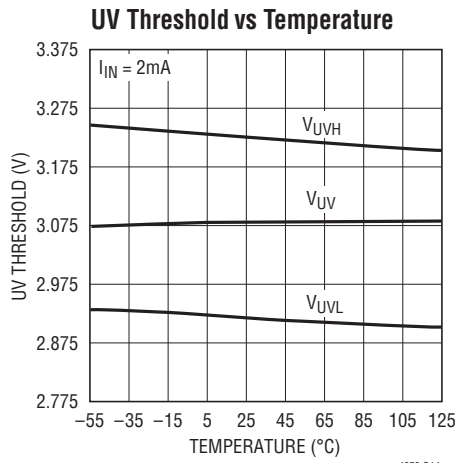
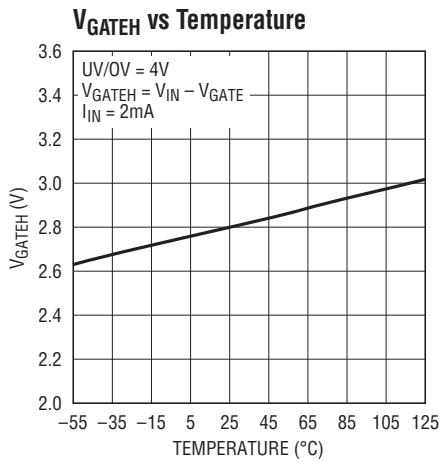
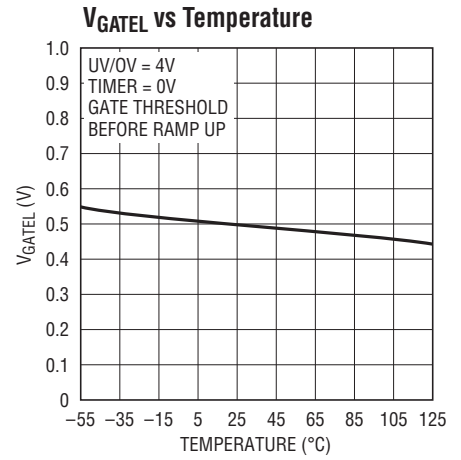
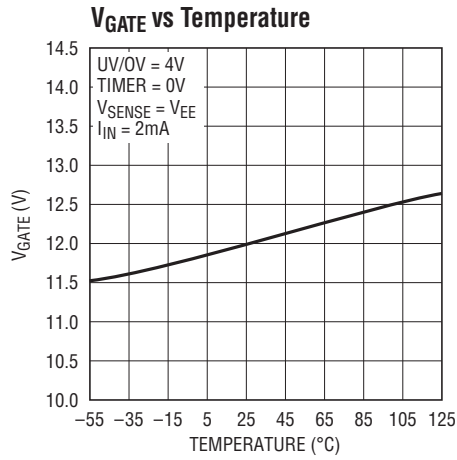
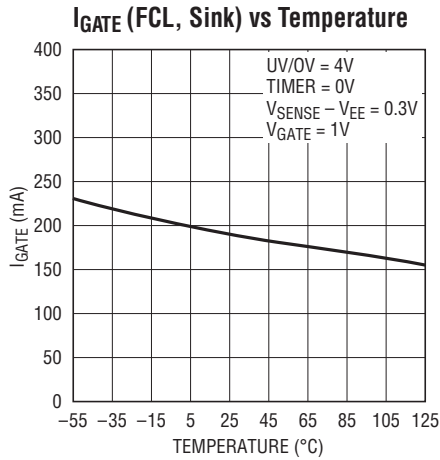

TYPICAL PERFORMANCE CHARACTERISTICS

I_{TMR} (Initial Cycle, Sourcing) vs Temperature

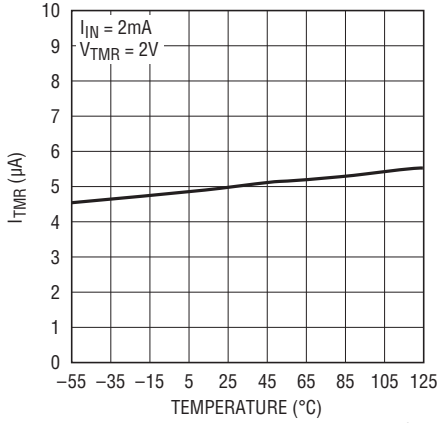

I_{TMR} (Circuit Breaker, Sourcing) vs Temperature

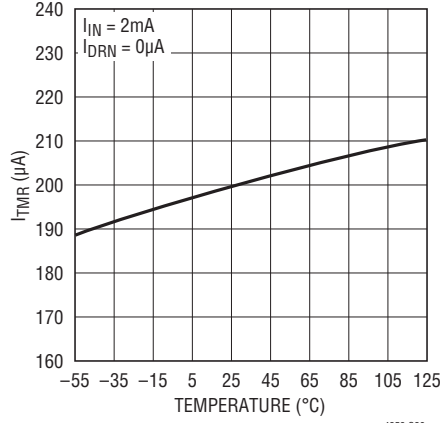

I_{TMR} vs I_{DRN}

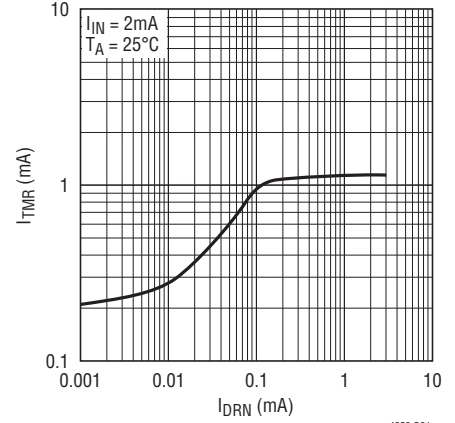

$\Delta I_{TMRACC}/\Delta I_{DRN}$ vs Temperature

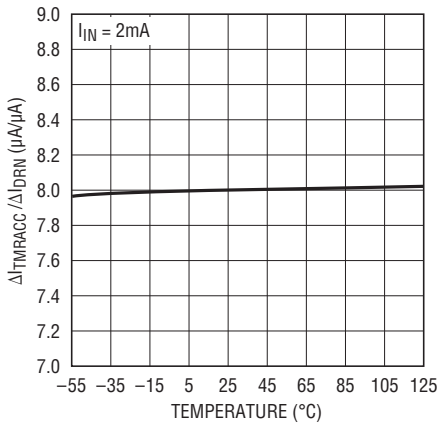

SQTIMER Threshold vs Temperature

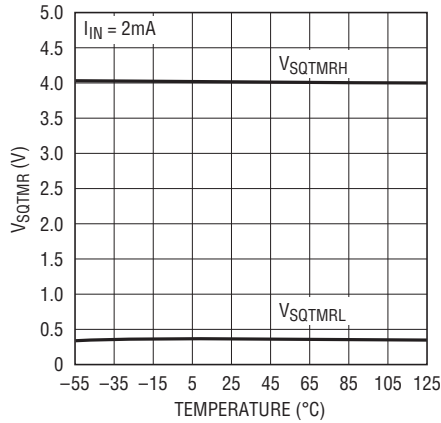

V_{DRNL} vs Temperature

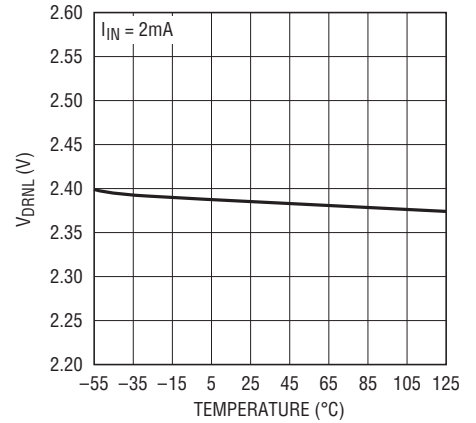

V_{DRNCL} vs Temperature

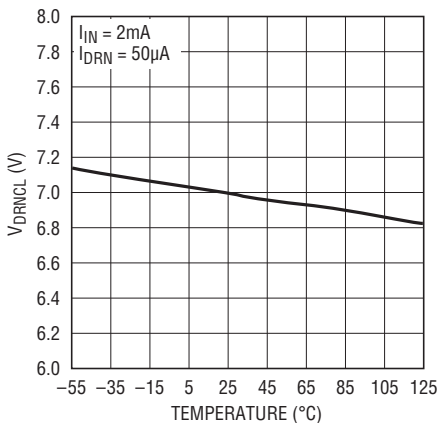

I_{DRN} vs V_{DRAIN}

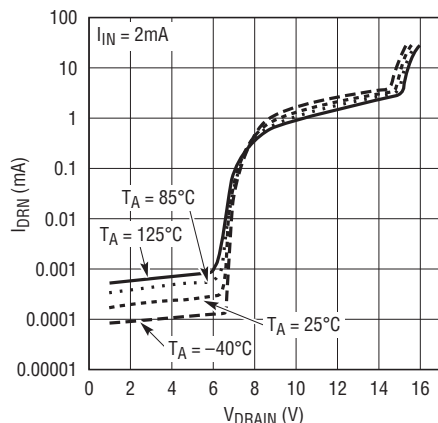

V_{PGL} vs Temperature

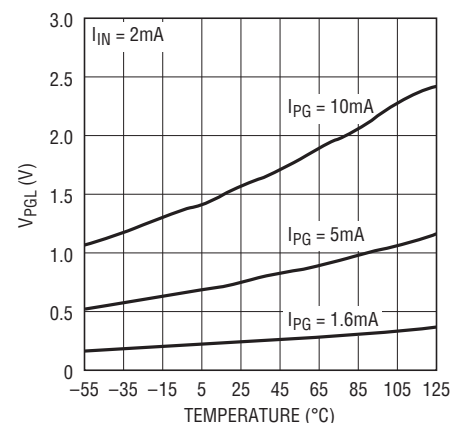

TYPICAL PERFORMANCE CHARACTERISTICS

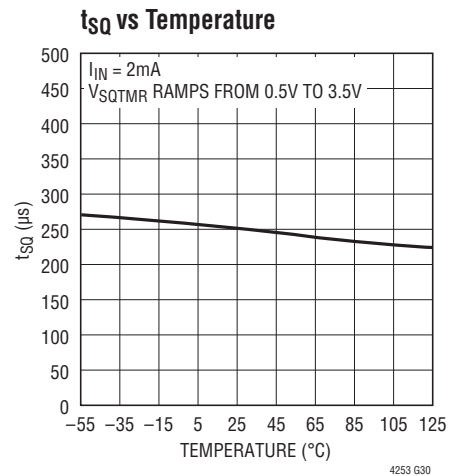
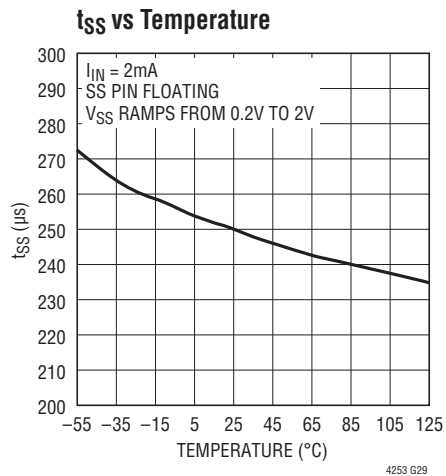
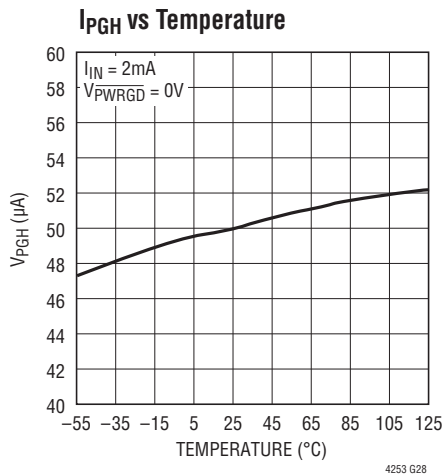

PIN FUNCTIONS

EN2 (Pin 1): Power Good Status Output Two Enable. This is a TTL compatible input that is used to control $\overline{PWRGD2}$ and $\overline{PWRGD3}$ outputs. When EN2 is driven low, both $\overline{PWRGD2}$ and $\overline{PWRGD3}$ will go high. When EN2 is driven high, $\overline{PWRGD2}$ will go low provided $\overline{PWRGD1}$ has been active for more than one power good sequence delay (t_{SQT}) provided by the sequencing timer. EN2 can be used to control the power good sequence. This pin is internally pulled low by a 120 μ A current source.

$\overline{PWRGD2}$ (Pin 2): Power Good Status Output Two. Power good sequence starts with $\overline{PWRGD1}$ latching active low. $\overline{PWRGD2}$ will latch active low after EN2 goes high and after one power good sequence delay t_{SQT} provided by the sequencing timer from the time $\overline{PWRGD1}$ goes low, whichever comes later. $\overline{PWRGD2}$ is reset by $\overline{PWRGD1}$ going high or EN2 going low. This pin is internally pulled high by a 50 μ A current source.

$\overline{PWRGD1}$ (Pin 3): Power Good Status Output One. At start-up, $\overline{PWRGD1}$ latches active low and starts the power good sequence when the DRAIN pin is below 2.39V and GATE is within 2.8V of V_{IN} . $\overline{PWRGD1}$ status is reset by UV, V_{IN} (UVLO), RESET going high or circuit breaker fault time-out. This pin is internally pulled high by a 50 μ A current source.

V_{IN} (Pin 4): Positive Supply Input. Connect this pin to the positive side of the supply through a dropping resistor. A shunt regulator clamps V_{IN} at 13V above V_{EE} . An internal undervoltage lockout (UVLO) circuit holds GATE low until the V_{IN} pin is greater than V_{LKO} , overriding UV and OV. If UV is high, OV is low and V_{IN} comes out of UVLO, TIMER starts an initial timing cycle before initiating GATE ramp up. If V_{IN} drops below approximately 8.2V (8.5V for the LTC4253A), GATE pulls low immediately.

RESET (Pin 5): Circuit Breaker Reset Pin. This is an asynchronous TTL compatible input. RESET going high will pull GATE, SS, TIMER, SQTIMER low and the \overline{PWRGD} outputs high. The RESET pulse must be wide enough to discharge any voltage on the TIMER pin below V_{TMRL} . After the reset of a latched fault, the chip waits for the interlock conditions before recovering as described in Interlock Conditions in the Operation section.

SS (Pin 6): Soft-Start Pin. This pin is used to ramp inrush current during start up, thereby effecting control over di/dt. A 20X attenuated version of the SS pin voltage is presented to the current limit amplifier. This attenuated voltage limits the MOSFET's drain current through the sense resistor during the soft-start current limiting. At the beginning of

PIN FUNCTIONS

the start-up cycle, the SS capacitor (C_{SS}) is ramped by a $22\mu\text{A}$ ($28\mu\text{A}$ for the LTC4253A) current source. The GATE pin is held low until SS exceeds $20 \cdot V_{OS} = 0.2\text{V}$. SS is internally shunted by a 100k R_{SS} which limits the SS pin voltage to 2.2V (50k resistor and 1.4V for the LTC4253A). This corresponds to an analog current limit SENSE voltage of 100mV (60mV for the LTC4253A). If the SS capacitor is omitted, the SS pin ramps up in about $250\mu\text{s}$ ($140\mu\text{s}$ for the LTC4253A). The SS pin is pulled low under any of the following conditions: UVLO at V_{IN} , UV, OV, during the initial timing cycle, a circuit breaker fault time-out or the RESET pin going high.

SENSE (Pin 7): Circuit Breaker/Current Limit Sense Pin. Load current is monitored by a sense resistor R_S connected between SENSE and V_{EE} , and controlled in three steps. If SENSE exceeds V_{CB} (50mV), the circuit breaker comparator activates a $(200\mu\text{A} + 8 \cdot I_{DRN})$ TIMER pull-up current. If SENSE exceeds V_{ACL} , the analog current-limit amplifier pulls GATE down to regulate the MOSFET current at V_{ACL}/R_S . In the event of a catastrophic short-circuit, SENSE may overshoot V_{ACL} . If SENSE reaches V_{FCL} (200mV), the fast current-limit comparator pulls GATE low with a strong pull-down. To disable the circuit breaker and current limit functions, connect SENSE to V_{EE} .

V_{EE} (Pin 8): Negative Supply Voltage Input. Connect this pin to the negative side of the power supply.

GATE (Pin 9): N-channel MOSFET Gate Drive Output. This pin is pulled high by a $50\mu\text{A}$ current source. GATE is pulled low by invalid conditions at V_{IN} (UVLO), UV, OV, during the initial timing cycle, a circuit breaker fault time-out or the RESET pin going high. GATE is actively servoed to control the fault current as measured at SENSE. Compensation capacitor, C_C , at GATE stabilizes this loop. A comparator monitors GATE to ensure that it is low before allowing an initial timing cycle, then the GATE ramps up after an over-voltage event or restart after a current limit fault. During GATE start-up, a second comparator detects GATE within 2.8V of V_{IN} before $\overline{\text{PWRGD1}}$ can be set and power good sequencing starts.

DRAIN (Pin 10): Drain Sense Input. Connecting an external resistor, R_D between this pin and the MOSFET's drain (V_{OUT}) allows voltage sensing below 6.15V (5V for LTC4253A) and current feedback to TIMER. A comparator detects if DRAIN is below 2.39V and together with the GATE high comparator, sets the $\overline{\text{PWRGD1}}$ flag. If V_{OUT} is above V_{DRNCL} , the DRAIN pin is clamped at approximately V_{DRNCL} . R_D current is internally multiplied by 8 and added to TIMER's $200\mu\text{A}$ during a circuit breaker fault cycle. This reduces the fault time and MOSFET heating.

OV (Pin 11): Overvoltage Input. For the LTC4253, the threshold at the OV pin is set at 6.15V with 0.3V hysteresis. If $OV > 6.15\text{V}$, GATE pulls low. When OV returns below 5.85V , GATE start-up begins without an initial timing cycle. The LTC4253A OV threshold is set at 5.09V with 102mV hysteresis. If $OV > 5.09\text{V}$, GATE pulls low. When OV returns below 4.988V , GATE start-up begins without an initial timing cycle. If OV occurs in the middle of an initial timing cycle, the initial timing cycle is restarted after OV goes away. OV does not reset the latched fault or $\overline{\text{PWRGD1}}$ flag. The internal UVLO at V_{IN} always overrides OV. A 1nF to 10nF capacitor at OV prevents transients and switching noise from affecting the OV thresholds and prevents glitches at the GATE.

UV (Pin 12): Undervoltage Input. For the LTC4253, the threshold at the UV pin is set at 3.225V with 0.3V hysteresis. If $UV < 2.925\text{V}$, $\overline{\text{PWRGD1}}$ pulls high, both GATE and TIMER pull low. If UV rises above 3.225V , this initiates an initial timing cycle followed by GATE start-up. The LTC4253A UV threshold is set at 3.08V with 324mV hysteresis. If $UV < 2.756\text{V}$, $\overline{\text{PWRGD1}}$ pulls high, both GATE and TIMER pull low. If UV rises above 3.08V , this initiates an initial timing cycle followed by GATE start-up. The internal UVLO at V_{IN} always overrides UV. A low at UV resets an internal fault latch. A 1nF to 10nF capacitor at UV prevents transients and switching noise from affecting the UV thresholds and prevents glitches at the GATE pin.

PIN FUNCTIONS

TIMER (Pin 13): Timer Input. Timer is used to generate an initial timing delay at start-up, and to delay shutdown in the event of an output overload (circuit breaker fault). Timer starts an initial timing cycle when the following conditions are met: RESET is low, UV is high, OV is low, V_{IN} clears UVLO, TIMER pin is low, GATE pin is lower than V_{GATEL} , $SS < 0.2V$, and $V_{SENSE} - V_{EE} < V_{CB}$. A pull-up current of $5\mu A$ then charges C_T , generating a time delay. If C_T charges to V_{TMRH} (4V), the timing cycle terminates. TIMER quickly pulls low and GATE is activated.

If SENSE exceeds 50mV while GATE is high, a circuit breaker cycle begins with a $200\mu A$ pull-up current charging C_T . If DRAIN is approximately 7V (6V for the LTC4253A) during this cycle, the timer pull-up has an additional current of $8 \cdot I_{DRN}$. If SENSE drops below 50mV before TIMER reaches 4V, a $5\mu A$ pull-down current slowly discharges the C_T . In the event that C_T eventually integrates up to the V_{TMRH} (4V) threshold, the circuit breaker trips, GATE quickly pulls low and $\overline{PWRGD1}$ pulls high. TIMER latches high with a $5\mu A$ pull-up source. This latched fault may be cleared by driving RESET high until TIMER is pulled low. Other ways of clearing the fault include pulling the V_{IN} pin momentarily below ($V_{LKO} - V_{LKH}$), pulling TIMER low with an external device or pulling UV below 2.925V (2.756V for the LTC4253A).

SQTIMER (Pin 14): Sequencing Timer Input. The sequencing timer provides a delay t_{SQT} for the power good sequencing. This delay is adjusted by connecting an appropriate capacitor to this pin. If the SQTIMER capacitor is omitted, the SQTIMER pin ramps from 0V to 4V in about 300 μs .

EN3 (Pin 15): Power Good Status Output Three Enable. This is a TTL compatible input that is used to control the $\overline{PWRGD3}$ output. When EN3 is driven low, $\overline{PWRGD3}$ will go high. When EN3 is driven high, $\overline{PWRGD3}$ will go low provided $\overline{PWRGD2}$ has been active for more than one power good sequence delay (t_{SQT}). EN3 can be used to control the power good sequence. This pin is internally pulled low by a $120\mu A$ current source.

$\overline{PWRGD3}$ (Pin 16): Power Good Status Output Three. Power good sequence starts with $\overline{PWRGD1}$ latching active low. $\overline{PWRGD3}$ will latch active low after EN3 goes high and after one power good sequence delay t_{SQT} provided by the sequencing timer from the time $\overline{PWRGD2}$ goes low, whichever comes later. $\overline{PWRGD3}$ is reset by $\overline{PWRGD1}$ going high or EN3 going low. This pin is internally pulled high by a $50\mu A$ current source.

BLOCK DIAGRAM

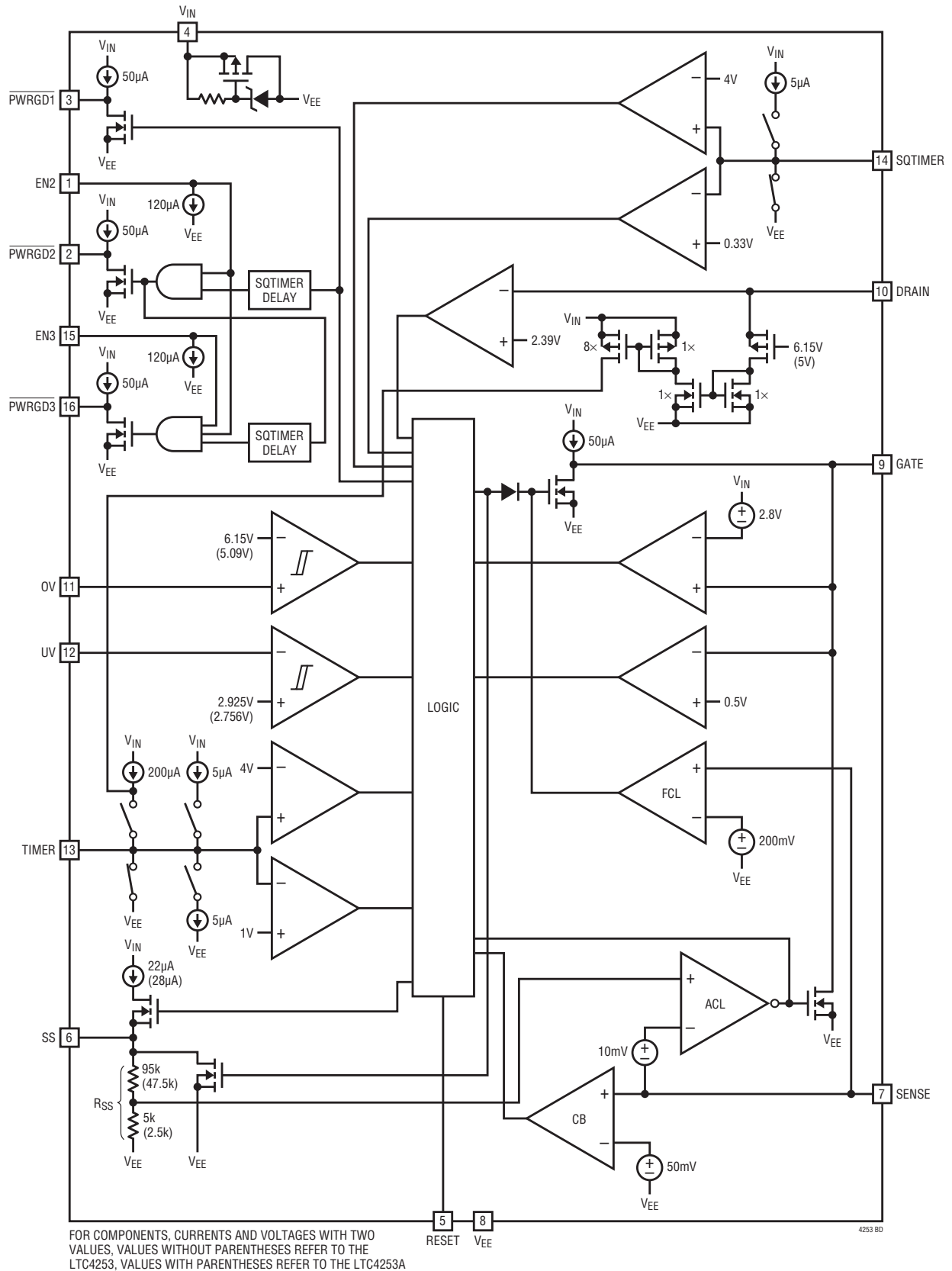

OPERATION

Interlock Conditions

A start-up sequence commences once these “interlock” conditions are met:

1. The input voltage V_{IN} exceeds V_{LKO} (UVLO).
2. The voltage at UV $> V_{UVHI}$ (V_{UV} for the LTC4253A).
3. The voltage at OV $< V_{OVLO}$ ($V_{OV} - V_{OVHST}$ for the LTC4253A).
4. The input voltage at RESET $< 0.8V$.
5. The (SENSE – V_{EE}) voltage $< 50mV$ (V_{CB})
6. The voltage at SS is $< 0.2V$ ($20 \cdot V_{OS}$)
7. The voltage on the TIMER capacitor (C_T) is $< 1V$ (V_{TMRL}).
8. The voltage at GATE is $< 0.5V$ (V_{GATEL})

The first four conditions are continuously monitored and the latter four are checked prior to initial timing or GATE ramp-up. Upon exiting an OV condition, the TIMER pin voltage requirement is inhibited. Details are described in the Applications Information, Timing Waveforms section.

If RESET $< 0.8V$ occurs after the LTC4253/LTC4253A come out of UVLO (interlock condition 1) and undervoltage (interlock condition 2), GATE and SS are released without an initial TIMER cycle once the other interlock conditions are met (see Figure 13a). If not, TIMER begins the start-up sequence by sourcing $5\mu A$ into C_T . If V_{IN} , UV or OV falls out of range or RESET asserts, the start-up cycle stops and TIMER discharges C_T to less than $1V$, then waits until the aforementioned conditions are once again met. If C_T successfully charges to $4V$, TIMER pulls low and both SS and GATE pins are released. GATE sources $50\mu A$ (I_{GATE}), charging the MOSFET gate and associated capacitance. The SS voltage ramp limits V_{SENSE} to control the inrush current. $\overline{PWRGD1}$ pulls active low when GATE is within $2.8V$ of V_{IN} and DRAIN is lower than V_{DRNL} . This sets off the power good sequence in which $\overline{PWRGD2}$ and then $\overline{PWRGD3}$ is subsequently pulled low after a delay, adjustable through the SQTIMER capacitor C_{SQ} or by external control inputs EN2 and EN3. In this way, external loads or power modules controlled by the three \overline{PWRGD} signals are turned on in a controlled manner without overloading the power bus.

Two modes of operation are possible during the time the MOSFET is first turned on, depending on the values of external components, MOSFET characteristics and nominal design current. One possibility is that the MOSFET will turn on gradually so that the inrush into the load capacitance remains a low value. The output will simply ramp to $-48V$ and the LTC4253/LTC4253A will fully enhance the MOSFET. A second possibility is that the load current exceeds the soft-start current limit threshold of $[V_{SS}(t)/20 - V_{OS}]/R_S$. In this case the LTC4253/LTC4253A ramp the output by sourcing soft-start limited current into the load capacitance. If the soft-start voltage is below $1.2V$, the circuit breaker TIMER is held low. Above $1.2V$, TIMER ramps up. It is important to set the timer delay so that, regardless of which start-up mode is used, the TIMER ramp is less than one circuit breaker delay time. If this condition is not met, the LTC4253/LTC4253A may shut down after one circuit breaker delay time.

Board Removal

When the board is withdrawn from the card cage, the UV/OV divider is the first to lose connection. This shuts off the MOSFET and commutates the flow of current in the connector. When the power pins subsequently separate there is no arcing.

Current Control

Three levels of protection handle short-circuit and overload conditions. Load current is monitored by SENSE and resistor R_S . There are three distinct thresholds at SENSE: $50mV$ for a timed circuit breaker function; $100mV$ for an analog current limit loop ($60mV$ for the LTC4253A); and $200mV$ for a fast, feedforward comparator which limits peak current in the event of a catastrophic short-circuit.

If, due to an output overload, the voltage drop across R_S exceeds $50mV$, TIMER sources $200\mu A$ into C_T . C_T eventually charges to a $4V$ threshold and the LTC4253/LTC4253A shut off. If the overload goes away before C_T reaches $4V$ and SENSE measures less than $50mV$, C_T slowly discharges ($5\mu A$). In this way the LTC4253/LTC4253A's circuit breaker function responds to low duty cycle overloads, and accounts for the fast heating and slow cooling characteristic of the MOSFET.

OPERATION

Higher overloads are handled by an analog current limit loop. If the drop across R_S reaches V_{ACL} , the current limiting loop servos the MOSFET gate and maintains a constant output current of V_{ACL}/R_S . In current limit mode, V_{OUT} (MOSFET drain-source voltage drop) typically rises and this increases MOSFET heating. If $V_{OUT} > V_{DRNCL}$, connecting an external resistor, R_D between V_{OUT} and DRAIN allows the fault timing cycle to be shortened by accelerating the charging of the TIMER capacitor. The TIMER pull-up current is increased by $8 \cdot I_{DRN}$. Note that because $SENSE > 50mV$, TIMER charges C_T during this time, and the LTC4253/LTC4253A eventually shut down.

Low impedance failures on the load side of the LTC4253/LTC4253A, coupled with 48V or more driving potential, can produce current slew rates well in excess of $50A/\mu s$. Under these conditions, overshoot is inevitable. A fast SENSE comparator with a threshold of 200mV detects overshoot and pulls GATE low much harder and hence much faster than the weaker current limit loop. The V_{ACL}/R_S current limit loop then takes over and servos the current as previously described. As before, TIMER runs and shuts down the LTC4253/LTC4253A when C_T reaches 4V.

If C_T reaches 4V, the LTC4253/LTC4253A latch off with a $5\mu A$ pull-up current source. The LTC4253/LTC4253A circuit breaker latch is reset by either pulling the RESET pin active high until TIMER goes low, pulling UV momentarily low, dropping the input voltage V_{IN} below the internal UVLO threshold or pulsing TIMER momentarily low with a switch.

Although short-circuits are the most obvious fault type, several operating conditions may invoke overcurrent protection. Noise spikes from the backplane or load, input steps caused by the connection of a second, higher voltage supply, transient currents caused by faults on adjacent circuit boards sharing the same power bus or the insertion of non-hot swappable products could cause higher than anticipated input current and temporary detection of an overcurrent condition. The action of TIMER and C_T rejects these events allowing the LTC4253/LTC4253A to “ride out” temporary overloads and disturbances that could trip a simple current comparator and, in some cases, blow a fuse.

APPLICATIONS INFORMATION

SHUNT REGULATOR

A fast responding shunt regulator clamps the V_{IN} pin to 13V (V_Z). Power is derived from $-48RTN$ by an external current limiting resistor, R_{IN} . A $1\mu F$ decoupling capacitor, C_{IN} filters supply transients and contributes a short delay at start-up.

To meet creepage requirements R_{IN} may be split into two or more series connected units. This introduces a wider total spacing than is possible with a single component while at the same time ballasting the potential across the gap under each resistor. The LTC4253 is fundamentally a low voltage device that operates with $-48V$ as its reference ground. To further protect against arc discharge into its

pins, the area in and around the LTC4253 and all associated components should be free of any other planes such as chassis ground, return, or secondary-side power and ground planes.

V_{IN} may be biased with additional current up to 30mA, to accommodate external loading such as the \overline{PWRGD} optocouplers shown in Figure 2. As an alternative to running higher current, simply buffer V_{IN} with an emitter follower as shown in Figure 3. A method that cascodes the \overline{PWRGD} outputs as shown in Figure 17.

V_{IN} is rated to handle 30mA within the thermal limits of the package, and is tested to survive a $100\mu s$, 100mA

APPLICATIONS INFORMATION

The separate UV and OV pins can be used for wider operating range such as 35.6V to 76.3V range as shown in Figure 2. Other combinations are possible with different resistors arrangement.

UV/OV COMPARATORS (LTC4253A)

A UV hysteretic comparator detects undervoltage conditions at the UV pin, with the following thresholds:

$$UV \text{ low-to-high } (V_{UV}) = 3.08V$$

$$UV \text{ high-to-low } (V_{UV} - V_{UVHST}) = 2.756V$$

An OV hysteretic comparator detects overvoltage conditions at the OV pin, with the following thresholds:

$$OV \text{ low-to-high } (V_{OV}) = 5.09V$$

$$OV \text{ high-to-low } (V_{OV} - V_{OVHST}) = 4.988V$$

The UV and OV trip point ratio is designed to match the standard telecom operating range of 43V to 71V when connected together as in Figure 3. A divider (R1, R2) is used to scale the supply voltage. Using R1 = 392k and R2 = 30.1k gives a typical operating range of 43.2V to 71.4V. The undervoltage shutdown and overvoltage recovery thresholds are then 38.6V and 69.9V. 1% divider resistors are recommended to preserve threshold accuracy.

The R1-R2 divider values shown in Figure 3 set a standing current of slightly more than 100 μ A and define an impedance at UV/OV of 28k Ω . In most applications, 28k Ω impedance coupled with 324mV UV hysteresis makes the LTC4253A insensitive to noise. If more noise immunity is desired, add a 1nF to 10nF filter capacitor from UV/OV to V_{EE}.

The UV and OV pins can also be used for a wider operating range by adding a resistor between UV and OV as shown in Figure 2 for the LTC4253. Other combinations are possible with different resistor arrangements.

UV/OV OPERATION

A low input to the UV comparator will reset the chip and pull the GATE and TIMER pins low. A low-to-high UV transition will initiate an initial timing sequence if the other interlock conditions are met. A high-to-low transition in the UV comparator immediately shuts down the LTC4253/LTC4253A, pulls the MOSFET gate low and resets the three latched $\overline{\text{PWRGD}}$ signals high.

An overvoltage condition is detected by the OV comparator and pulls GATE low, thereby shutting down the load, but it will not reset the circuit breaker TIMER and $\overline{\text{PWRGD}}$ flags. Returning from the overvoltage condition will restart the GATE pin if all the interlock conditions except TIMER are met. Only during the initial timing cycle does OV condition have an effect of resetting TIMER.

DRAIN

Connecting an external resistor, R_D, to this dual function DRAIN pin allows V_{OUT} (MOSFET drain-source voltage drop) sensing without it being damaged by large voltage transients. Below 5V, negligible pin leakage allows a DRAIN low comparator to detect V_{OUT} less than 2.39V (V_{DRNCL}). This, together with the GATE low comparator, sets the $\overline{\text{PWRGD}}$ flag.

When V_{OUT} > V_{DRNCL}, the DRAIN pin is clamped at V_{DRNCL} and the current flowing in R_D is given by:

$$I_{DRN} \approx \frac{V_{OUT} - V_{DRNCL}}{R_D} \quad (1)$$

This current is scaled up 8 times during a circuit breaker fault before being added to the nominal 200 μ A. This accelerates the fault TIMER pull-up when the MOSFET's drain-source voltage exceeds V_{DRNCL} and effectively shortens the MOSFET heating duration.

APPLICATIONS INFORMATION

TIMER

The operation of the TIMER pin is somewhat complex as it handles several key functions. A capacitor C_T is used at TIMER to provide timing for the LTC4253/LTC4253A. Four different charging and discharging modes are available at TIMER:

1. $5\mu\text{A}$ slow charge; initial timing delay.
2. $(200\mu\text{A} + 8 \cdot I_{\text{DRN}})$ fast charge; circuit breaker delay.
3. $5\mu\text{A}$ slow discharge; circuit breaker “cool-off.”
4. Low impedance switch; resets the TIMER capacitor after an initial timing delay, in UVLO, in UV and in OV during initial timing and when RESET is high.

For initial timing delay, the $5\mu\text{A}$ pull-up is used. The low impedance switch is turned off and the $5\mu\text{A}$ current source is enabled when the interlock conditions are met. C_T charges to 4V in a time period given by:

$$t = \frac{4V \cdot C_T}{5\mu\text{A}} \quad (2)$$

When C_T reaches V_{TMRH} (4V), the low impedance switch turns on and discharges C_T . A GATE start-up cycle begins and both SS and GATE outputs are released.

CIRCUIT BREAKER TIMER OPERATION

If the SENSE pin detects more than 50mV drop across R_S , the TIMER pin charges C_T with $(200\mu\text{A} + 8 \cdot I_{\text{DRN}})$. If C_T charges to 4V, the GATE pin pulls low and the LTC4253/LTC4253A latch off. The LTC4253/LTC4253A remain latched off until the RESET pin is momentarily pulsed high, the UV pin is momentarily pulsed low, the TIMER pin is momentarily discharged low by an external switch or V_{IN} dips below UVLO and is then restored. The circuit breaker timeout period is given by:

$$t = \frac{4V \cdot C_T}{200\mu\text{A} + 8 \cdot I_{\text{DRN}}} \quad (3)$$

If $V_{\text{OUT}} < 5V$, an internal PMOS isolates DRAIN pin leakage current and this makes $I_{\text{DRN}} = 0$ in Equation (3). If V_{OUT} is above V_{DRNCL} during the circuit breaker fault period, the charging of C_T is accelerated by $8 \cdot I_{\text{DRN}}$ of Equation (1).

Intermittent overloads may exceed the 50mV threshold at SENSE but, if their duration is sufficiently short, TIMER will not reach 4V and the LTC4253/LTC4253A will not shut the external MOSFET off. To handle this situation, the TIMER discharges C_T slowly with a $5\mu\text{A}$ pull-down whenever the SENSE voltage is less than 50mV. Therefore, any intermittent overload with $V_{\text{OUT}} < 5V$ and an aggregate duty cycle of more than 2.5% will eventually trip the circuit breaker and shut down the LTC4253/LTC4253A. Figure 4 shows the circuit breaker response time in seconds normalized to $1\mu\text{F}$. The asymmetric charging and discharging of C_T is a fair gauge of MOSFET heating.

The normalized circuit response time is estimated by:

$$\frac{t}{C_T(\mu\text{F})} = \frac{4}{[(205 + 8 \cdot I_{\text{DRN}}) \cdot D - 5]} \quad \text{for } D > 2.5\% \quad (4)$$

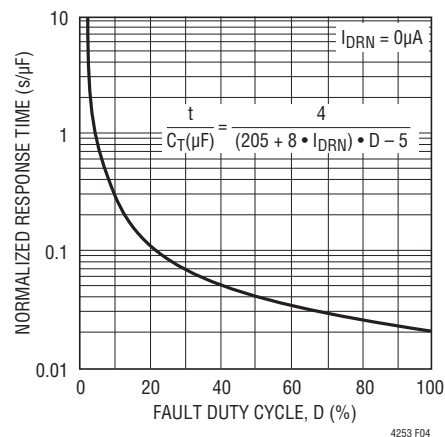

Figure 4. Circuit Breaker Response Time

APPLICATIONS INFORMATION

POWER GOOD SEQUENCING

After the initial TIMER cycle, GATE ramps up to turn on the external MOSFET which in turn pulls DRAIN low.

When GATE is within 2.8V of V_{IN} and DRAIN is lower than V_{DRNL} , the power good sequence starts with $\overline{PWRGD1}$ pulling active low. This starts off a 5 μ A pull-up on the SQTIMER pin which ramps up until it reaches the 4V threshold then pulls low. When the SQTIMER pin floats, this delay t_{SQT} is about 300 μ s. Connecting an external capacitor C_{SQ} from SQTIMER to V_{EE} modifies the delay to:

$$t_{SQT} = \frac{4V \cdot C_{SQ}}{5\mu A} \quad (5)$$

$\overline{PWRGD2}$ asserts when EN2 goes high and $\overline{PWRGD1}$ has asserted for more than one t_{SQT} . When $\overline{PWRGD2}$ successfully pulls low, SQTIMER ramps up on another delay cycle. $\overline{PWRGD3}$ asserts when EN2 and EN3 go high and $\overline{PWRGD2}$ has asserted for more than one t_{SQT} .

All three \overline{PWRGD} signals are reset in UVLO, in UV condition, if RESET is high or when C_T charges up to 4V. In addition, $\overline{PWRGD2}$ is reset by EN2 going low. $\overline{PWRGD3}$ is reset by EN2 or EN3 going low. An overvoltage condition has no effect on the \overline{PWRGD} flags. A 50 μ A current pulls each \overline{PWRGD} pin high when reset. As power modules signal common are different from \overline{PWRGD} , optoisolation is recommended. These three pins can sink an optodiode current. Figure 17 shows an NPN configuration for the \overline{PWRGD} interface. A limiting base resistor should be used for each NPN and the module enable input should have protection from negative bias current.

SOFT-START

Soft-start is effective in limiting the inrush current during GATE start-up. Unduly long soft-start intervals can exceed the MOSFET's SOA duration if powering-up into an active load. When the SS pin floats, an internal current source ramps SS from 0V to 2.2V in about 300 μ s (0V to 1.4V in about 200 μ s for the LTC4253A). Connecting an external capacitor, C_{SS} , from SS to ground modifies the ramp to approximate an RC response of:

$$V_{SS}(t) \approx V_{SS} \left(1 - e^{-\frac{t}{R_{SS}C_{SS}}} \right) \quad (6)$$

An internal resistor divider (95k/5k for the LTC4253 and 47.5k/2.5k for the LTC4253A) scales $V_{SS}(t)$ down by 20 times to give the analog current limit threshold:

$$V_{ACL}(t) = \frac{V_{SS}(t)}{20} - V_{OS} \quad (7)$$

This allows the inrush current to be limited to $V_{ACL}(t)/R_S$. The offset voltage, V_{OS} (10mV), ensures C_{SS} is sufficiently discharged and the ACL amplifier is in current limit mode before GATE start-up. SS is discharged low during UVLO at V_{IN} , UV, OV, during the initial timing cycle, a latched circuit breaker fault or the RESET pin going high.

GATE

GATE is pulled low to V_{EE} under any of the following conditions: in UVLO, when RESET pulls high, in an undervoltage condition, in an overvoltage condition, during the initial timing cycle or a latched circuit breaker fault. When GATE turns on, a 50 μ A current source charges the MOSFET gate and any associated external capacitance. V_{IN} limits the gate drive to no more than 14.5V.

Gate-drain capacitance (C_{GD}) feedthrough at the first abrupt application of power can cause a gate-source voltage sufficient to turn on the MOSFET. A unique circuit pulls GATE low with practically no usable voltage at V_{IN} and eliminates current spikes at insertion. A large external gate-source capacitor is thus unnecessary for the purpose of compensating C_{GD} . Instead, a smaller value (≥ 10 nF) capacitor C_C is adequate. C_C also provides compensation for the analog current limit loop.

GATE has two comparators: the GATE low comparator looks for <0.5V threshold prior to initial timing; the GATE high comparator looks for <2.8V relative to V_{IN} and, together with DRAIN low comparator, sets $\overline{PWRGD1}$ output during GATE start-up.

APPLICATIONS INFORMATION

Sense

The SENSE pin is monitored by the circuit breaker (CB) comparator, the analog current limit (ACL) amplifier, and the fast current limit (FCL) comparator. Each of these three measures the potential of SENSE relative to V_{EE} . When SENSE exceeds 50mV, the CB comparator activates the 200 μ A TIMER pull-up. At 100mV (60mV for the LTC4253A) the ACL amplifier servos the MOSFET current, and at 200mV the FCL comparator abruptly pulls GATE low in an attempt to bring the MOSFET current under control. If any of these conditions persists long enough for TIMER to charge C_T to 4V (see Equation 3), the LTC4253/LTC4253A shut down and pull GATE low.

If the SENSE pin encounters a voltage greater than V_{ACL} , the ACL amplifier will servo GATE downwards in an attempt to control the MOSFET current. Since GATE overdrives the MOSFET in normal operation, the ACL amplifier needs time to discharge GATE to the threshold of the MOSFET. For a mild overload the ACL amplifier can control the MOSFET current, but in the event of a severe overload the current may overshoot. At SENSE = 200mV the FCL comparator takes over, quickly discharging the GATE pin to near V_{EE} potential. FCL then releases, and the ACL amplifier takes over. All the while TIMER is running. The effect of FCL is to add a nonlinear response to the control loop in favor of reducing MOSFET current.

Owing to inductive effects in the system, FCL typically overcorrects the current limit loop, and GATE undershoots. A zero in the loop (resistor R_C in series with the gate capacitor) helps the ACL amplifier to recover.

SHORT-CIRCUIT OPERATION

Circuit behavior arising from a load side low impedance short is shown in Figure 5. Initially the current overshoots the analog current limit level of $V_{SENSE} = 200$ mV (trace 2) as the GATE pin works to bring V_{GS} under control (trace 3). The overshoot glitches the backplane in the negative direction and when the current is reduced to 100 mV/ R_S , the backplane responds by glitching in the positive direction.

TIMER commences charging C_T (trace 4) while the analog current limit loop maintains the fault current at 100 mV/ R_S , which in this case is 5A (trace 2). Note that the backplane voltage (trace 1) sags under load. Timer pull-up is accelerated by V_{OUT} . When C_T reaches 4V, GATE turns off, the \overline{PWRGD} signals pull high, the load current drops to zero and the backplane rings up to over 100V. The transient associated with the GATE turn-off can be controlled with a snubber to reduce ringing and a transient voltage suppressor (such as Diodes Inc. SMAT70A) to clip off large spikes. The choice of RC for the snubber is usually done experimentally. The value of the snubber capacitor is usually chosen between 10 to 100 times the MOSFET C_{OSS} . The value of the snubber resistor is typically between 3Ω to 100Ω .

A low impedance short on one card may influence the behavior of others sharing the same backplane. The initial glitch and backplane sag as seen in Figure 5 trace 1, can rob charge from output capacitors on the adjacent card. When the faulty card shuts down, current flows in to refresh the capacitors. If LTC4253/LTC4253A are used by the other cards, they respond by limiting the inrush current to a value of V_{ACL}/R_S . If C_T is sized correctly, the capacitors will recharge long before C_T times out.

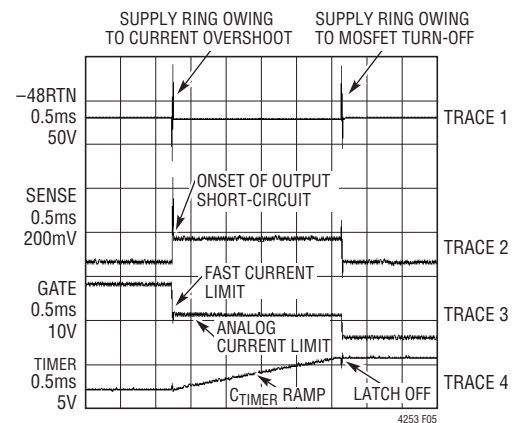

Figure 5. Output Short-Circuit Behavior of LTC4253

APPLICATIONS INFORMATION

MOSFET SELECTION

The external MOSFET switch must have adequate safe operating area (SOA) to handle short-circuit conditions until TIMER times out. These considerations take precedence over DC current ratings. A MOSFET with adequate SOA for a given application can always handle the required current but the opposite may not be true. Consult the manufacturer's MOSFET data sheet for safe operating area and effective transient thermal impedance curves.

MOSFET selection is a 3-step process by assuming the absence of soft-start capacitor. First, R_S is calculated and then the time required to charge the load capacitance is determined. This timing, along with the maximum short-circuit current and maximum input voltage, defines an operating point that is checked against the MOSFET's SOA curve.

To begin a design, first specify the required load current and load capacitance, I_L and C_L . The circuit breaker current trip point (V_{CB}/R_S) should be set to accommodate the maximum load current. Note that maximum input current to a DC/DC converter is expected at $V_{SUPPLY(MIN)}$. R_S is given by:

$$R_S = \frac{V_{CB(MIN)}}{I_L(MAX)} \quad (8)$$

where $V_{CB(MIN)} = 40\text{mV}$ (45mV for the LTC4253A) represents the guaranteed minimum circuit breaker threshold.

During the initial charging process, the LTC4253/LTC4253A may operate the MOSFET in current limit, forcing (V_{ACL}) between 80mV to 120mV (V_{ACL} is 54mV to 66mV for the LTC4253A) across R_S . The minimum inrush current is given by:

$$I_{INRUSH(MIN)} = \frac{V_{ACL(MIN)}}{R_S} \quad (9)$$

Maximum short-circuit current limit is calculated using the maximum V_{SENSE} . This gives

$$I_{SHORTCIRCUIT(MAX)} = \frac{V_{ACL(MAX)}}{R_S} \quad (10)$$

The TIMER capacitor C_T must be selected based on the slowest expected charging rate; otherwise TIMER might time out before the load capacitor is fully charged. A value for C_T is calculated based on the maximum time it takes the load capacitor to charge. That time is given by:

$$t_{CL(CHARGE)} = \frac{C \cdot V}{I} = \frac{C_L \cdot V_{SUPPLY(MAX)}}{I_{INRUSH(MIN)}} \quad (11)$$

The maximum current flowing in the DRAIN pin is given by:

$$I_{DRN(MAX)} = \frac{V_{SUPPLY(MAX)} - V_{DRNCL}}{R_D} \quad (12)$$

Approximating a linear charging rate, I_{DRN} drops from $I_{DRN(MAX)}$ to zero, the I_{DRN} component in Equation (3) can be approximated with $0.5 \cdot I_{DRN(MAX)}$. Rearranging the equation, TIMER capacitor C_T is given by:

$$C_T = \frac{t_{CL(CHARGE)} \cdot (200\mu\text{A} + 4 \cdot I_{DRN(MAX)})}{4\text{V}} \quad (13)$$

Returning to Equation (3), the TIMER period is calculated and used in conjunction with $V_{SUPPLY(MAX)}$ and $I_{SHORTCIRCUIT(MAX)}$ to check the SOA curves of a prospective MOSFET.

As a numerical design example for the LTC4253, consider a 30W load, which requires 1A input current at 36V. If $V_{SUPPLY(MAX)} = 72\text{V}$ and $C_L = 100\mu\text{F}$, $R_D = 1\text{M}\Omega$, Equation (8) gives $R_S = 40\text{m}\Omega$; Equation (13) gives $C_T = 414\text{nF}$. To account for errors in R_S , C_T , TIMER current (200 μA), TIMER threshold (4V), R_D , DRAIN current multiplier and DRAIN voltage clamp (V_{DRNCL}), the calculated value should be multiplied by 1.5, giving the nearest standard value of $C_T = 680\text{nF}$.

If a short-circuit occurs, a current of up to $120\text{mV}/40\text{m}\Omega = 3\text{A}$ will flow in the MOSFET for 6.3ms as dictated by $C_T = 680\text{nF}$ in Equation (3). The MOSFET must be selected based on this criterion. The IRF530S can handle 100V and 3A for 10ms and is safe to use in this application.

APPLICATIONS INFORMATION

Computing the maximum soft-start capacitor value during soft-start to a load short is complicated by the nonlinear MOSFET's SOA characteristics and the $R_{SS}C_{SS}$ response. An overconservative but simple approach begins with the maximum circuit breaker current, given by:

$$I_{CB(MAX)} = \frac{V_{CB(MAX)}}{R_S} \quad (14)$$

where $V_{CB(MAX)}$ is 60mV (55mV for the LTC4253A).

From the SOA curves of a prospective MOSFET, determine the time allowed, $t_{SOA(MAX)}$. C_{SS} is given by:

$$C_{SS} = \frac{t_{SOA(MAX)}}{0.916 \cdot R_{SS}} \quad \text{for the LTC4253}$$

$$C_{SS} = \frac{t_{SOA(MAX)}}{2.48 \cdot R_{SS}} \quad \text{for the LTC4253A} \quad (15)$$

In the above example, 60mV/40m Ω gives 1.5A. t_{SOA} for the IRF530S is 40ms. From Equation (15), $C_{SS} = 437$ nF. Actual board evaluation showed that $C_{SS} = 100$ nF was appropriate. The ratio ($R_{SS} \cdot C_{SS}$) to $t_{CL(CHARGE)}$ is a good gauge as large ratios may result in the time-out period expiring prematurely. This gauge is determined empirically with board level evaluation.

SUMMARY OF DESIGN FLOW

To summarize the design flow, consider the application shown in Figure 3 for the LTC4253A. It was designed for 80W and $C_L = 100\mu\text{F}$.

Calculate maximum load current: $80\text{W}/43\text{V} = 1.86\text{A}$; allowing for 83% converter efficiency, $I_{IN(MAX)} = 2.2\text{A}$.

Calculate R_S : from Equation (8) $R_S = 20\text{m}\Omega$.

Calculate $I_{SHORT-CIRCUIT(MAX)}$: from Equation (10) $I_{SHORTCIRCUIT(MAX)} = 3.3\text{A}$.

Select a MOSFET that can handle 3.3A at 71V: IRF530S.

Calculate C_T : from Equation (13) $C_T = 302$ nF. Select $C_T = 680$ nF, which gives the circuit breaker time-out period $t_{MAX} = 5.9$ ms.

Consult MOSFET SOA curves: the IRF530S can handle 3.3A at 100V for 8.3ms, so it is safe to use in this application.

Calculate C_{SS} : using Equations (14) and (15) select $C_{SS} = 33$ nF.

FREQUENCY COMPENSATION

The LTC4253 typical frequency compensation network for the analog current limit loop is a series R_C (10 Ω) and C_C connected from GATE to V_{EE} . Figure 6 depicts the relationship between the compensation capacitor C_C and the MOSFET's C_{ISS} . The line in Figure 6 is used to select a starting value for C_C based upon the MOSFET's C_{ISS} specification. Optimized values for C_C are shown for several popular MOSFETs. Differences in the optimized value of C_C versus the starting value are small. Nevertheless, compensation values should be verified by board level short-circuit testing.

As seen in Figure 5, at the onset of a short-circuit event, the input supply voltage can ring dramatically due to series inductance. If this voltage avalanches the MOSFET, current continues to flow through the MOSFET to the output. The analog current limit loop cannot control this current flow and therefore the loop undershoots. This effect cannot be eliminated by frequency compensation. A Zener diode is required to clamp the input supply voltage and prevent MOSFET avalanche.

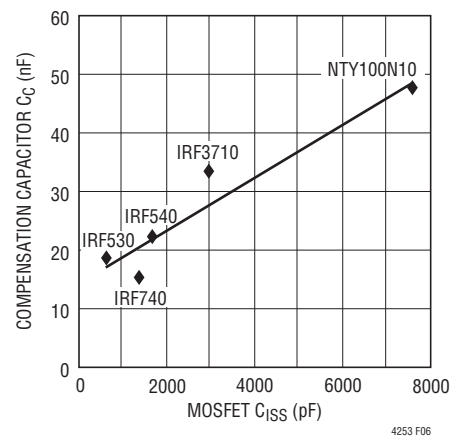

Figure 6. Recommended Compensation Capacitor C_C vs MOSFET C_{ISS} for the LTC4253

APPLICATIONS INFORMATION

SENSE RESISTOR CONSIDERATIONS

For proper circuit breaker operation, Kelvin-sense PCB connections between the sense resistor and the LTC4253/LTC4253A's V_{EE} and SENSE pins are strongly recommended. The drawing in Figure 7 illustrates the correct way of making connections between the LTC4253/LTC4253A and the sense resistor. PCB layout should be balanced and symmetrical to minimize wiring errors. In addition, the PCB layout for the sense resistor should include good thermal management techniques for optimal sense resistor power dissipation.

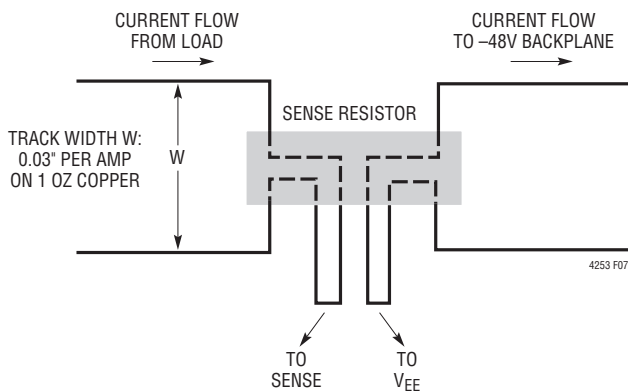

Figure 7. Making PCB Connections to the Sense Resistor

TIMING WAVEFORMS

System Power-Up

Figure 8 details the timing waveforms for a typical power-up sequence in the case where a board is already installed in the backplane and system power is applied abruptly. At time point 1, the supply ramps up, together with UV/OV, V_{OUT} and DRAIN. V_{IN} and the \overline{PWRGD} signals follow at a slower rate as set by the V_{IN} bypass capacitor. At time point 2, V_{IN} exceeds V_{LKO} and the internal logic checks for $UV > V_{UVHI}$ (V_{UV} for the LTC4253A), $OV < V_{OVL0}$ ($V_{OV} - V_{OVHST}$ for the LTC4253A), $RESET < 0.8V$, $GATE < V_{GATEL}$, $SENSE < V_{CB}$, $SS < 20 \cdot V_{OS}$, and $TIMER < V_{TMRL}$. When all conditions are met, initial timing starts and the TIMER

capacitor is charged by a $5\mu A$ current source pull-up. At time point 3, TIMER reaches the V_{TMRH} threshold and the initial timing cycle terminates. The TIMER capacitor is quickly discharged. At time point 4, the V_{TMRL} threshold is reached and the conditions of $GATE < V_{GATEL}$, $SENSE < V_{CB}$ and $SS < 20 \cdot V_{OS}$ must be satisfied before the GATE start-up cycle begins. SS ramps up as dictated by $R_{SS} \cdot C_{SS}$ (as in Equation 6); GATE is held low by the analog current limit (ACL) amplifier until SS crosses $20 \cdot V_{OS}$. Upon releasing GATE, $50\mu A$ sources into the external MOSFET gate and compensation network. When the GATE voltage reaches the MOSFET's threshold, current flows into the load capacitor at time point 5. At time point 6, load current reaches SS control level and the analog current limit loop activates. Between time points 6 and 8, the GATE voltage is servoed, the SENSE voltage is regulated at $V_{ACL}(t)$ (Equation 7) and soft-start limits the slew rate of the load current. If the SENSE voltage ($V_{SENSE} - V_{EE}$) reaches the V_{CB} threshold at time point 7, circuit breaker TIMER activates. The TIMER capacitor, C_T , is charged by a $(200\mu A + 8 \cdot I_{DRN})$ current pull-up. As the load capacitor nears full charge, load current begins to decline. At time point 8, the load current falls and the SENSE voltage drops below $V_{ACL}(t)$. The analog current limit loop shuts off and the GATE pin ramps further. At time point 9, the SENSE voltage drops below V_{CB} , the fault TIMER ends, followed by a $5\mu A$ discharge cycle (cool-off). The duration between time points 7 and 9 must be shorter than one circuit breaker delay to avoid fault time-out during GATE ramp-up. When GATE ramps past the V_{GATEH} threshold at time point A, $\overline{PWRGD1}$ pulls low. At time point B, GATE reaches its maximum voltage as determined by V_{IN} . At time point A, SQTIMER starts its ramp-up to 4V. Having satisfied the requirement that $\overline{PWRGD1}$ is low for more than one t_{SQT} , $\overline{PWRGD2}$ pulls low after EN2 pulls high above the V_{IH} threshold at time point C. This sets off the second SQTIMER ramp-up. Having satisfied the requirement that $\overline{PWRGD2}$ is low for more than one t_{SQT} , $\overline{PWRGD3}$ pulls low after EN3 pulls high at time point D.

APPLICATIONS INFORMATION

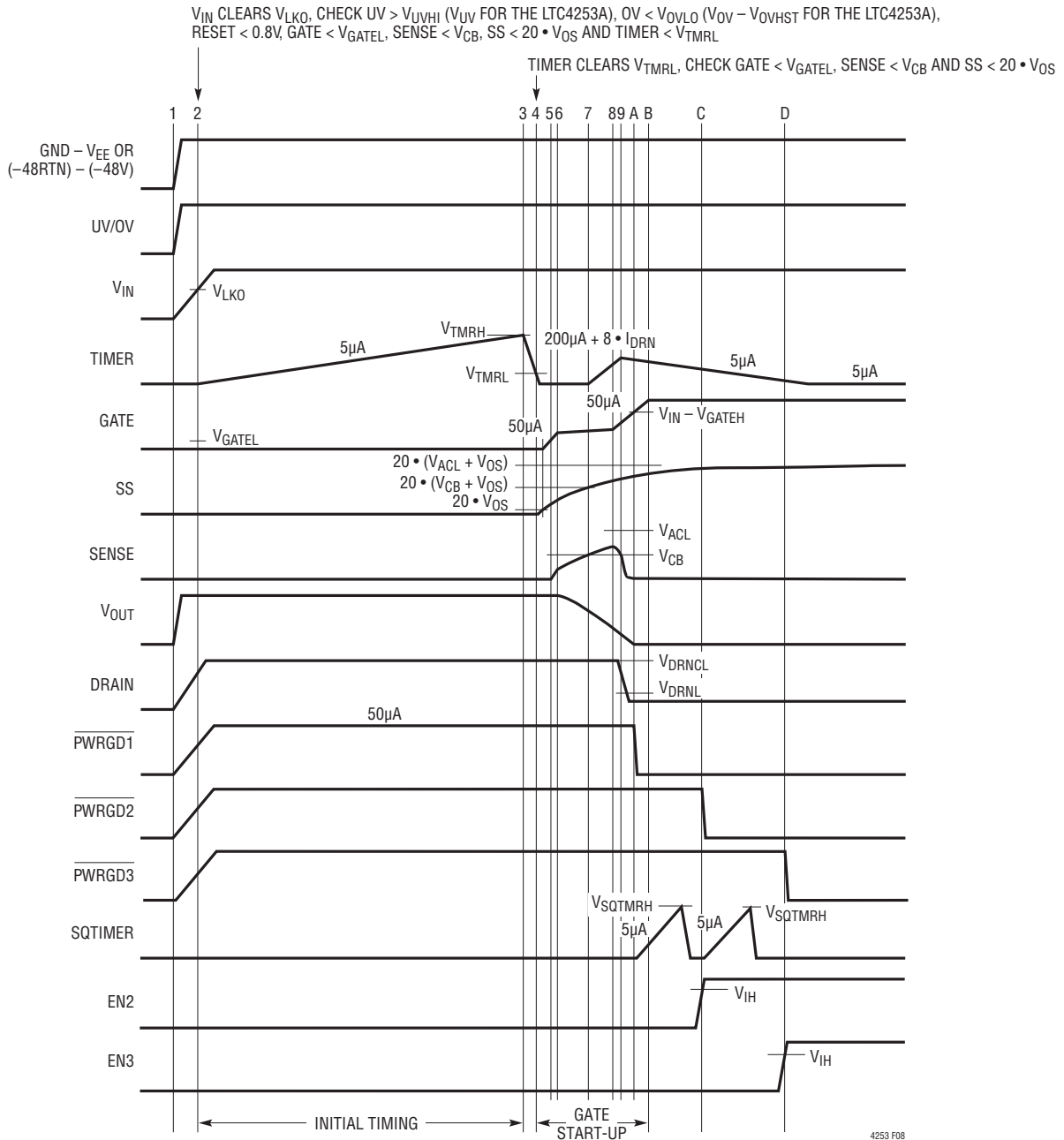

Figure 8. System Power-Up Timing (All Waveforms Are Referenced to V_{EE})

APPLICATIONS INFORMATION

Live Insertion with Short Pin Control of UV/OV

In the example shown in Figure 9, power is delivered through long connector pins whereas the UV/OV divider makes contact through a short pin. This ensures the power

connections are firmly established before the LTC4253/LTC4253A are activated. At time point 1, the power pins make contact and V_{IN} ramps through V_{LKO} . At time point 2, the UV/OV divider makes contact and its voltage exceeds

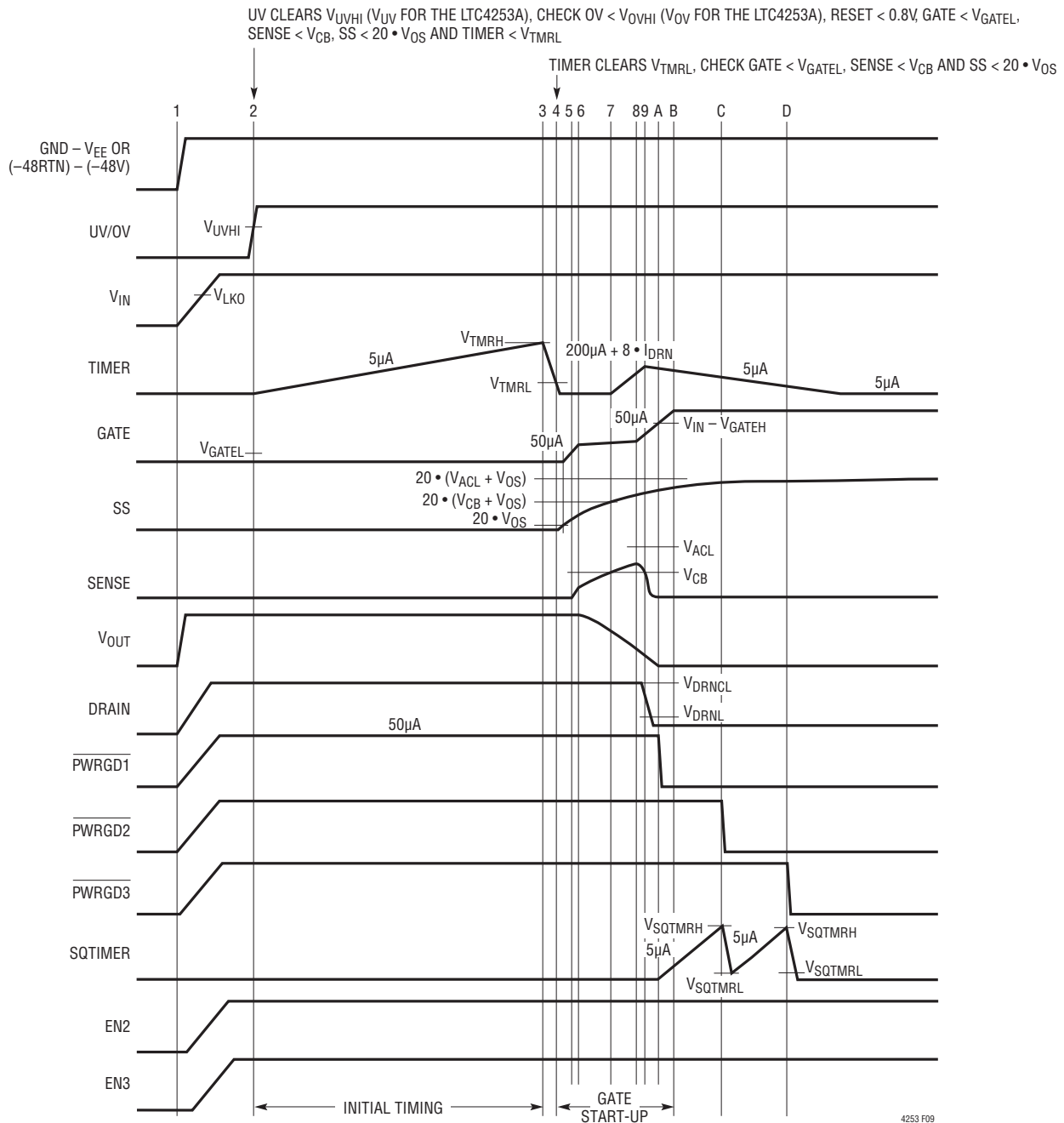

Figure 9. Power-Up Timing with a Short Pin (All Waveforms Are Referenced to VEE)

APPLICATIONS INFORMATION

V_{UVHI} (V_{UV} for the LTC4253A). In addition, the internal logic checks for $OV < V_{OVHI}$ (V_{OV} for the LTC4253A), $RESET < 0.8V$, $GATE < V_{GATEL}$, $SENSE < V_{CB}$, $SS < 20 \cdot V_{OS}$ and $TIMER < V_{TMRL}$. When all conditions are met, initial timing starts and the TIMER capacitor is charged by a $5\mu A$ current source pull-up. At time point 3, TIMER reaches the V_{TMRH} threshold and the initial timing cycle terminates. The TIMER capacitor is quickly discharged. At time point 4, the V_{TMRL} threshold is reached and the conditions of $GATE < V_{GATEL}$, $SENSE < V_{CB}$ and $SS < 20 \cdot V_{OS}$ must be satisfied before the GATE start-up cycle begins. SS ramps up as dictated by $R_{SS} \cdot C_{SS}$; GATE is held low by the analog current limit amplifier until SS crosses $20 \cdot V_{OS}$. Upon releasing GATE, $50\mu A$ sources into the external MOSFET gate and compensation network. When the GATE voltage reaches the MOSFET's threshold, current begins flowing into the load capacitor at time point 5. At time point 6, load current reaches SS control level and the analog current limit loop activates. Between time points 6 and 8, the GATE voltage is servoed and the SENSE voltage is regulated at $V_{ACL}(t)$ and soft-start limits the slew rate of the load current. If the SENSE voltage ($V_{SENSE} - V_{EE}$) reaches the V_{CB} threshold at time point 7, the circuit breaker TIMER activates. The TIMER capacitor, C_T is charged by a $(200\mu A + 8 \cdot I_{DRN})$ current pull-up. As the load capacitor nears full charge, load current begins to decline. At point 8, the load current falls and the SENSE voltage drops below $V_{ACL}(t)$. The analog current limit loop shuts off and the GATE pin ramps further. At time point 9, the SENSE voltage drops below V_{CB} and the fault TIMER ends, followed by a $5\mu A$ discharge current source (cool-off). When GATE ramps past V_{GATEH} threshold at time point A, $\overline{PWRGD1}$ pulls low, starting off the \overline{PWRGD} sequence. $\overline{PWRGD2}$ pulls low at time point C when EN2 is high and $\overline{PWRGD1}$ is low for more than one t_{SQT} . $\overline{PWRGD3}$ pulls low at time point D when EN2 and EN3 is high and $\overline{PWRGD2}$ is low for more than one t_{SQT} . At time point B, GATE reaches its maximum voltage as determined by V_{IN} .

Undervoltage Timing

In Figure 10 when the UV pin drops below V_{UVLO} ($V_{UV} - V_{UVHST}$ for the LTC4253A) at time point 1, the LTC4253/LTC4253A shut down with TIMER, SS and GATE pulled low. If current has been flowing, the SENSE pin voltage decreases to zero as GATE collapses. When UV recovers and clears V_{UVHI} (V_{UV} for the LTC4253A) at time point 2, an initial time cycle begins followed by a start-up cycle.

V_{IN} Undervoltage Lockout Timing

V_{IN} undervoltage lockout comparator, UVLO has a similar timing behavior as the UV pin timing except it looks at $V_{IN} < (V_{LKO} - V_{LKH})$ to shut down and $V_{IN} > V_{LKO}$ to start. In an undervoltage lockout condition, both UV and OV comparators are held off. When V_{IN} exits undervoltage lockout, the UV and OV comparators are enabled.

Overvoltage Timing

During normal operation, if the OV pin exceeds V_{OVHI} (V_{OV} for the LTC4253A) as shown at time point 1 of Figure 11, the TIMER and \overline{PWRGD} status are unaffected; SS and GATE pull down; load disconnects. At time point 2, OV recovers and drops below the V_{OVLO} ($V_{OV} - V_{OVHST}$ for the LTC4253A) threshold; GATE start-up begins. If the overvoltage glitch is long enough to deplete the load capacitor, time points 4 through 7 may occur.

Circuit Breaker Timing

In Figure 12a, the TIMER capacitor charges at $200\mu A$ if the SENSE pin exceeds V_{CB} but V_{DRN} is less than 5V. If the SENSE pin returns below V_{CB} before TIMER reaches the V_{TMRH} threshold, TIMER is discharged by $5\mu A$. In Figure 12b, when TIMER exceeds V_{TMRH} , GATE pulls down immediately and the chip shuts down. In Figure 12c, multiple momentary faults cause the TIMER capacitor to integrate and reach V_{TMRH} followed by GATE pull down and the chip shuts down. During chip shutdown, the LTC4253/LTC4253A latch TIMER high with a $5\mu A$ pull-up current source.

APPLICATIONS INFORMATION

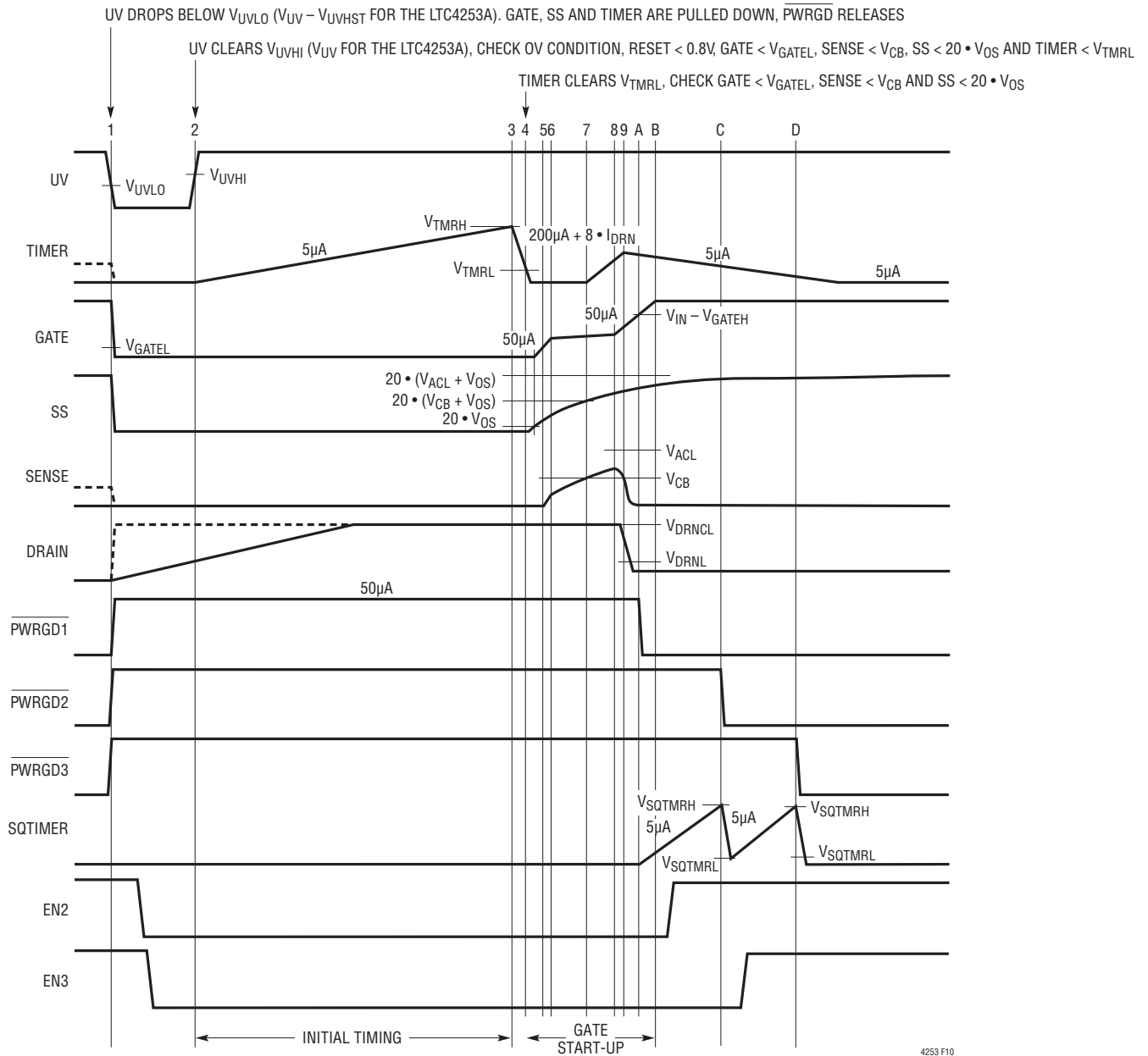

Figure 10. Undervoltage Timing (All Waveforms Are Referenced to V_{EE})

APPLICATIONS INFORMATION

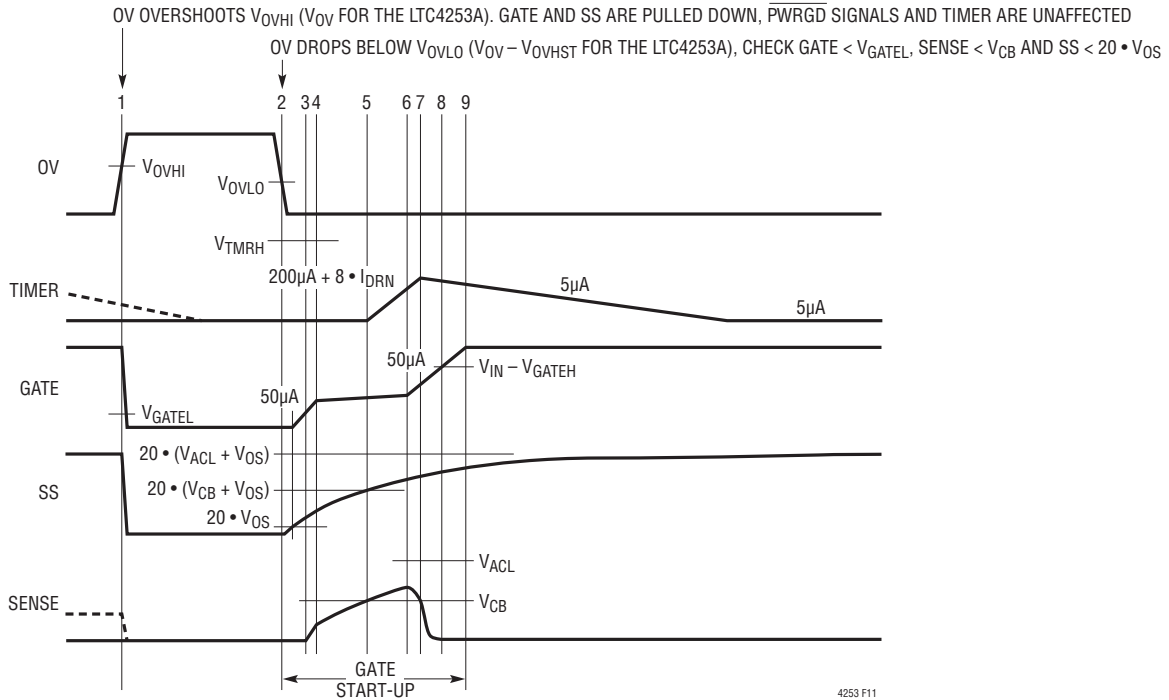
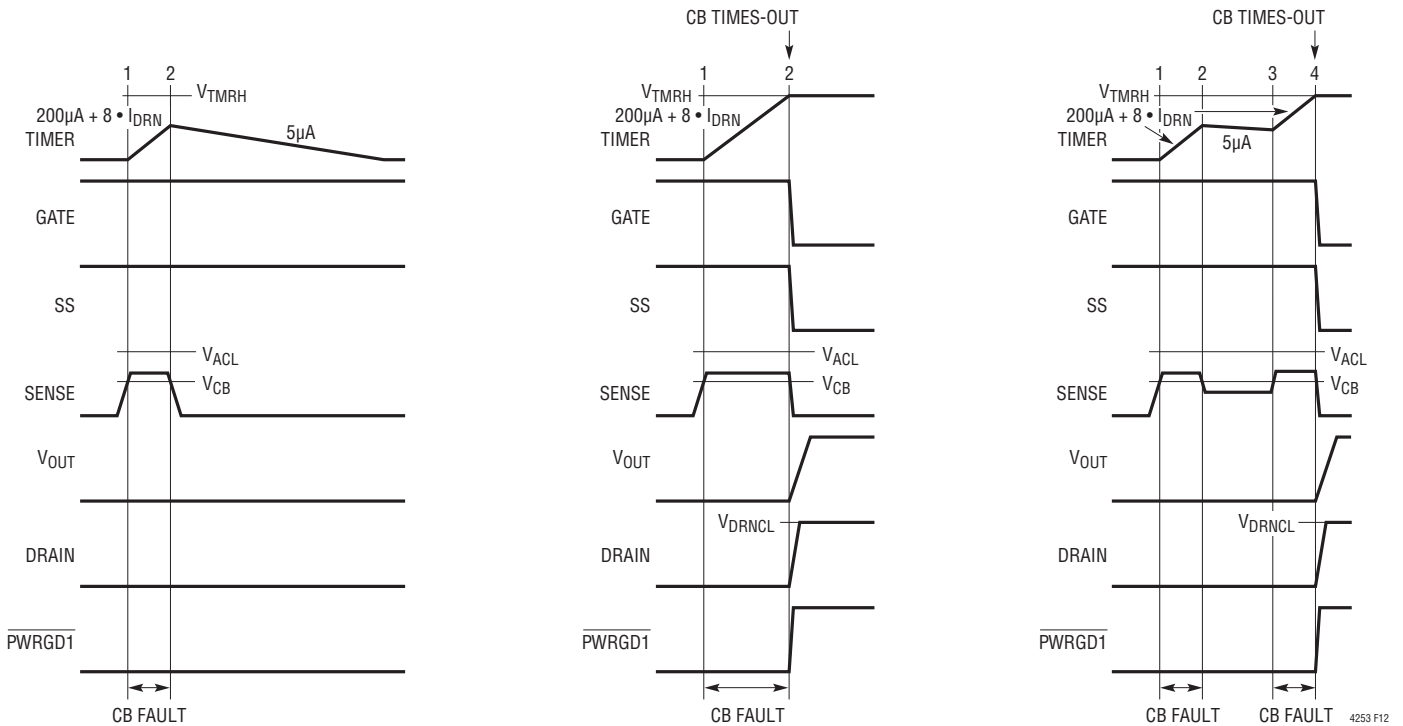

Figure 11. Overvoltage Timing (All Waveforms Are Referenced to V_{EE})



(12a) Momentary Circuit Breaker Fault

(12b) Circuit Breaker Time-Out

(12c) Multiple Circuit Breaker Fault

Figure 12. Circuit Breaker Timing Behavior (All Waveforms Are Referenced to V_{EE})

APPLICATIONS INFORMATION

Resetting a Fault Latch

A latched circuit breaker fault of the LTC4253/LTC4253A has the benefit of a long cooling time. The latched fault can be reset by pulsing the RESET pin high until the TIMER pin is pulled below V_{TMRL} (1V) as shown in Figure 13b. After the RESET pulse, SS and GATE ramp up without an initial timing cycle provided the interlock conditions are satisfied.

Alternative methods of reset include using an external switch to pulse the UV pin below V_{UVLO} ($V_{UV} - V_{UVHST}$ for the LTC4253A) or the V_{IN} pin below ($V_{LKO} - V_{LKH}$). Pulling the TIMER pin below V_{TMRL} and the SS pin to 0V then simultaneously releasing them also achieves a reset. An initial timing cycle is generated for reset by pulsing the UV pin or V_{IN} pin, while no initial timing cycle is generated for reset by pulsing of the TIMER and SS pins.

Using Reset as an ON/OFF Switch

The asynchronous RESET pin can be used as an ON/OFF function to cut off supply to the external power modules or loads controlled by the LTC4253/LTC4253A. Pulling RESET high will pull GATE, SS, TIMER and SQTIMER low and the \overline{PWRGD} signal high. The supply is fully cut off if the RESET pulse is maintained wide enough to fully discharge the GATE and SS pins. As long as RESET is high, GATE, SS, TIMER and SQTIMER are strapped to V_{EE} and the supply is cut off. When RESET is released, if the LTC4253/LTC4253A are in UVLO, UV, OV or $V_{SENSE} > V_{CB}$, turn-on is delayed until the interlock conditions are met before recovering as described in the Operation, Interlock Conditions section. If not, the GATE pin will ramp up in a soft start cycle without going through an initial cycle as in Figure 13c.

Analog Current Limit and Fast Current Limit

In Figure 14a, when SENSE exceeds V_{ACL} , GATE is regulated by the analog current limit amplifier loop. When SENSE drops below V_{ACL} , GATE is allowed to pull up. In Figure 14b, when a severe fault occurs, SENSE exceeds V_{FCL} and GATE immediately pulls down until the analog current amplifier establishes control. If the severe fault causes V_{OUT} to exceed V_{DRNCL} , the DRAIN pin is clamped at V_{DRNCL} . I_{DRN} flows into the DRAIN pin and is multiplied by 8. This extra current is added to the TIMER pull-up current of 200 μ A. This

accelerated TIMER current of $(200\mu A + 8 \cdot I_{DRN})$ produces a shorter circuit breaker fault delay. Careful selection of C_T , R_D and MOSFET helps prevent SOA damage in a low impedance fault condition.

Soft-Start

If the SS pin is not connected, this pin defaults to a linear voltage ramp, from 0V to 2.2V in about 300 μ s (0V to 1.4V in about 200 μ s for the LTC4253A) at GATE start-up, as shown in Figure 15a. If a soft-start capacitor, C_{SS} , is connected to this SS pin, the soft-start response is modified from a linear ramp to an RC response (Equation 6), as shown in Figure 15b. This feature allows load current to slowly ramp-up at GATE start-up. Soft-start is initiated at time point 3 by a TIMER transition from V_{TMRH} to V_{TMRL} (time points 1 and 2), by the OV pin falling below the V_{OVLO} ($V_{OV} - V_{OVHST}$ for the LTC4253A) threshold after an OV condition or by the RESET pin falling $< 0.8V$ after a Reset condition. When the SS pin is below 0.2V, the analog current limit amplifier keeps GATE low. Above 0.2V, GATE is released and 50 μ A ramps up the compensation network and GATE capacitance at time point 4. Meanwhile, the SS pin voltage continues to ramp up. When GATE reaches the MOSFET's threshold, the MOSFET begins to conduct. Due to the MOSFET's high g_m , the MOSFET current quickly reaches the soft-start control value of $V_{ACL}(t)$ (Equation 7). At time point 6, the GATE voltage is controlled by the current limit amplifier. The soft-start control voltage reaches the circuit breaker voltage, V_{CB} at time point 7 and the circuit breaker TIMER activates. As the load capacitor nears full charge, load current begins to decline below $V_{ACL}(t)$. The current limit loop shuts off and GATE releases at time point 8. At time point 9, SENSE voltage falls below V_{CB} and TIMER deactivates.

Large values of C_{SS} can cause premature circuit breaker time-out as $V_{ACL}(t)$ may marginally exceed the V_{CB} potential during the circuit breaker delay. The load capacitor is unable to achieve full charge in one GATE start-up cycle. A more serious side effect of a large C_{SS} value is that SOA duration may be exceeded during soft-start into a low impedance load. A soft-start voltage below V_{CB} will not activate the circuit breaker TIMER.

APPLICATIONS INFORMATION

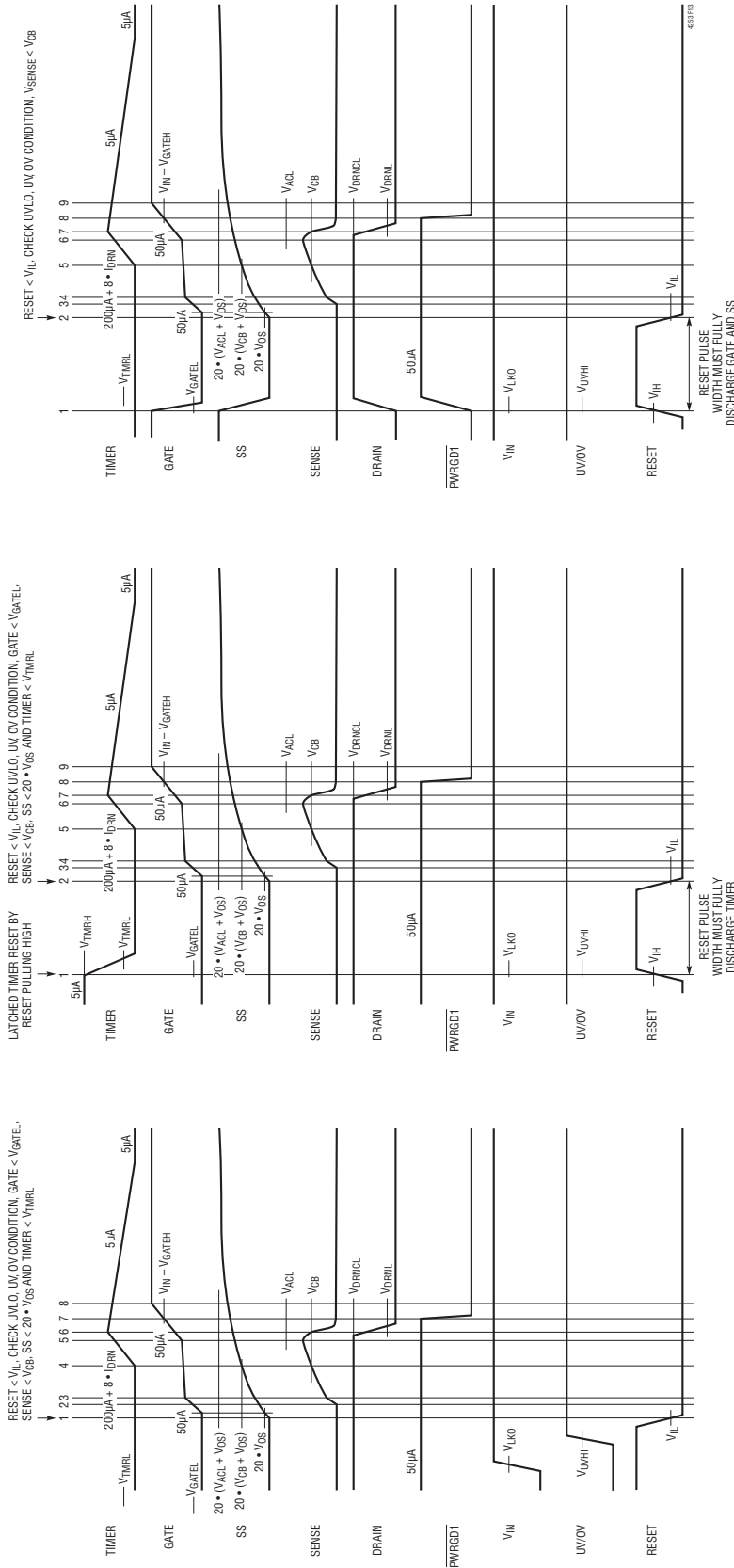

(13c) Reset as an ON/OFF Switch

(13b) Reset of the LTC4253/LTC4253A's Latched Fault

(13a) Reset Forcing Start-Up without Initial TIMER Cycle

Figure 13. Reset Functions (All Waveforms Are Referenced to VEE)

APPLICATIONS INFORMATION

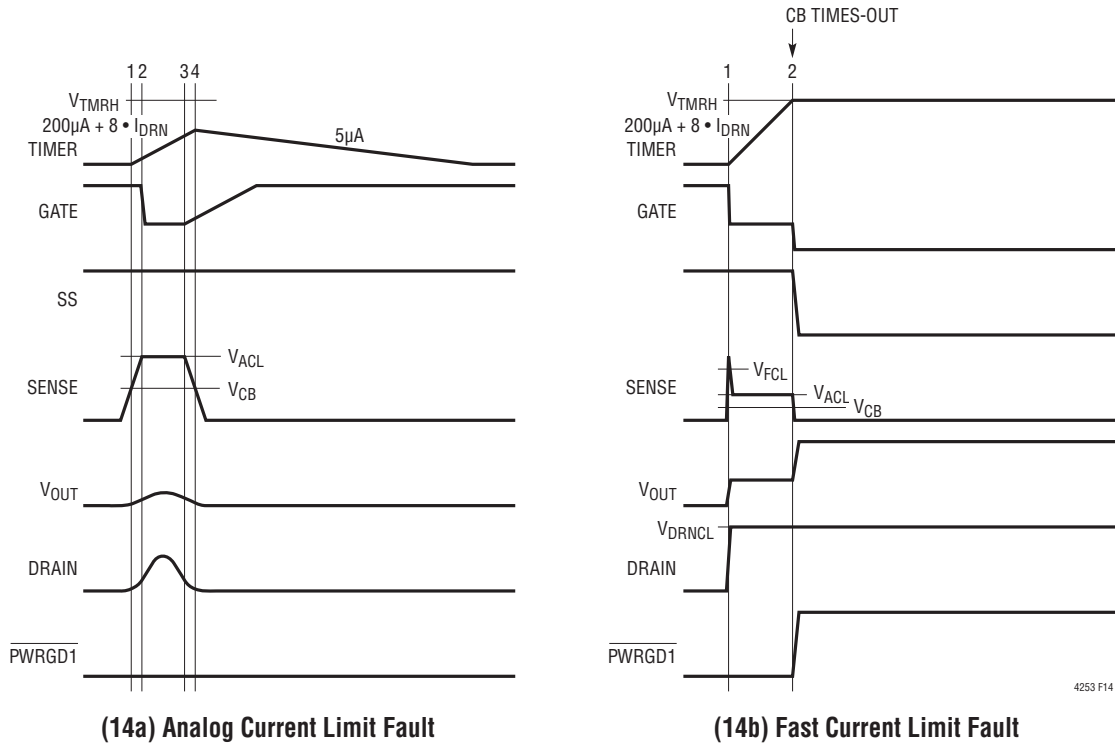

Figure 14. Current Limit Behavior (All Waveforms Are Referenced to V_{EE})

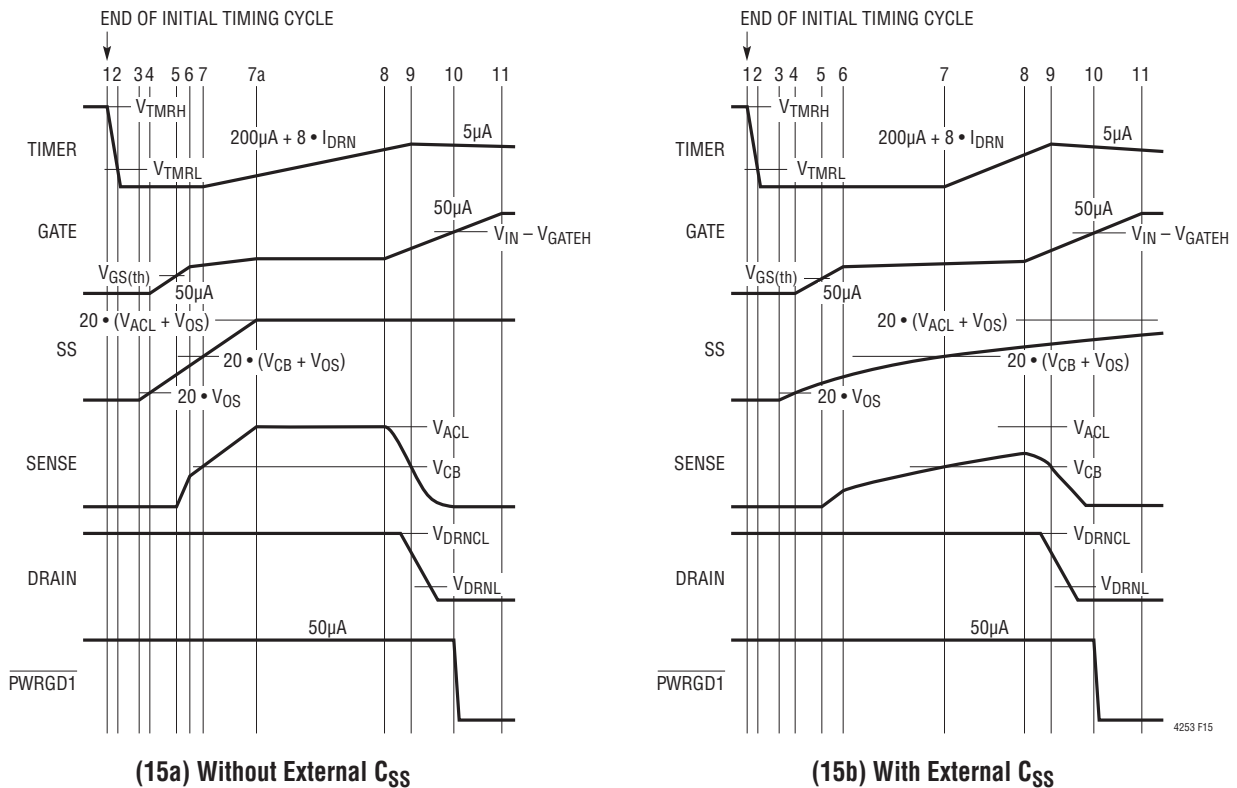

Figure 15. Soft-Start Timing (All Waveforms Are Referenced to V_{EE})

425353aff

APPLICATIONS INFORMATION

Power Limit Circuit Breaker

Figure 16 shows the LTC4253A in a power limit circuit breaking application. The SENSE pin is modulated by board voltage V_{SUPPLY} . The D1 Zener voltage, V_Z , is set to be the same as the lowest operating voltage, $V_{SUPPLY(MIN)} = 43V$. If the goal is to have the high supply operating voltage, $V_{SUPPLY(MAX)} = 71V$ give the same power as available at $V_{SUPPLY(MIN)}$, then resistors R3 and R4 are selected by:

$$\frac{R4}{R3} = \frac{V_{CB}}{V_{SUPPLY(MAX)}} \quad (16)$$

If R4 is 22Ω, then R3 is 31.6k. The peak circuit breaker power limit is:

$$POWER(MAX) = \frac{(V_{SUPPLY(MIN)} + V_{SUPPLY(MAX)})^2}{4 \cdot V_{SUPPLY(MIN)} \cdot V_{SUPPLY(MAX)}} \quad (17)$$

$$\begin{aligned} &\bullet \text{POWER AT } V_{SUPPLY(MIN)} \\ &= 1.064 \cdot \text{POWER AT } V_{SUPPLY(MIN)} \end{aligned}$$

$$\begin{aligned} \text{when } V_{SUPPLY} &= 0.5 \cdot (V_{SUPPLY(MIN)} + V_{SUPPLY(MAX)}) \\ &= 57V \end{aligned}$$

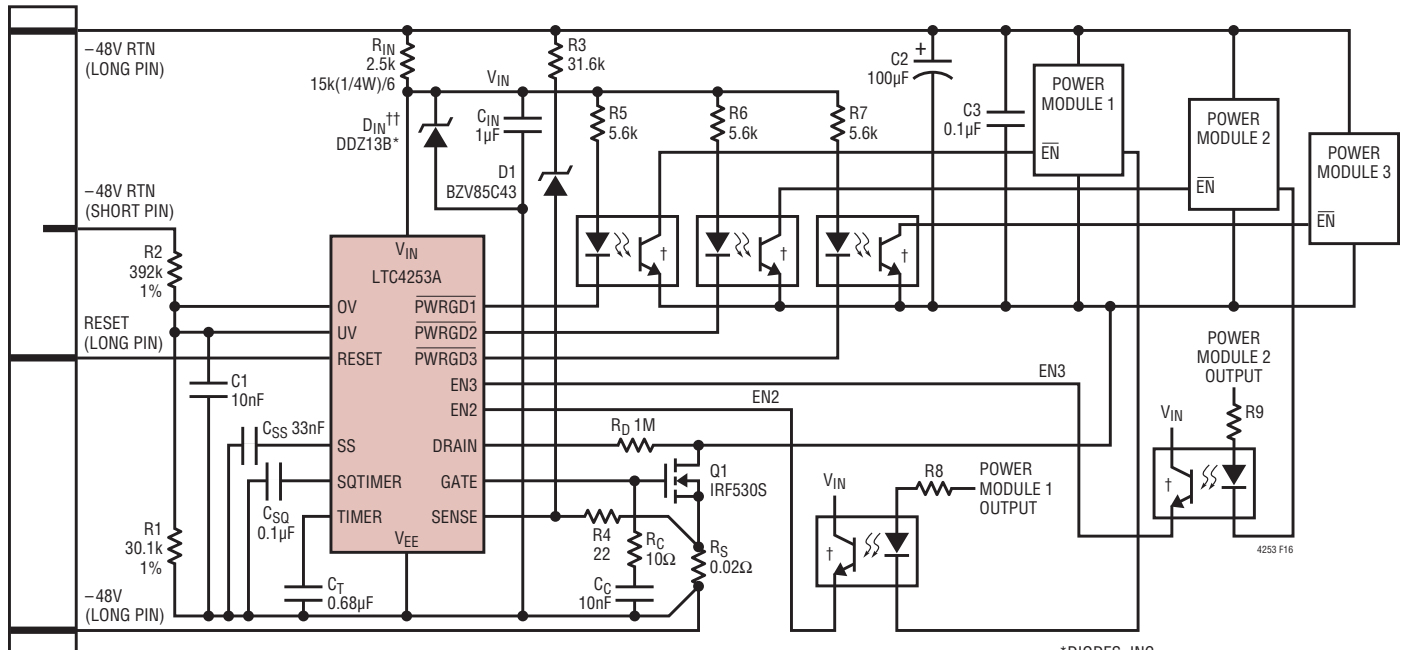

Figure 16. Power Limit Circuit Breaker Application

*DIODES, INC.
 †MOC207
 ††RECOMMENDED FOR HARSH ENVIRONMENTS.

APPLICATIONS INFORMATION

The peak power at the fault current limit occurs at the supply overvoltage threshold. The fault current limited power is:

$$\text{POWER(FAULT)} = \frac{(V_{\text{SUPPLY}})}{R_S} \cdot \left[V_{\text{ACL}} - (V_{\text{SUPPLY}} - V_Z) \cdot \frac{R_4}{R_3} \right] \quad (18)$$

Circuit Breaker with Foldback Current Limit

Figure 17 shows the LTC4253A in a foldback current limit application. When V_{OUT} is shorted to the -48V RTN supply, current flows through resistors R3 and R4. This results in a voltage drop across R4 and a corresponding reduction in voltage drop across the sense resistor, R_S , as the ACL amplifier servos the sense voltage between the SENSE and V_{EE} pins to about 60mV. The short-circuit current through R_S reduces as the V_{OUT} voltage increases during an output short-circuit condition. Without foldback current limiting resistor R4, the current is limited to 3A during analog current limit. With R4, the short-circuit current is limited to 0.5A when V_{OUT} is shorted to 71V.

PACKAGE DESCRIPTION

Please refer to <http://www.linear.com/designtools/packaging/> for the most recent package drawings.

GN Package 16-Lead Plastic SSOP (Narrow .150 Inch) (Reference LTC DWG # 05-08-1641)

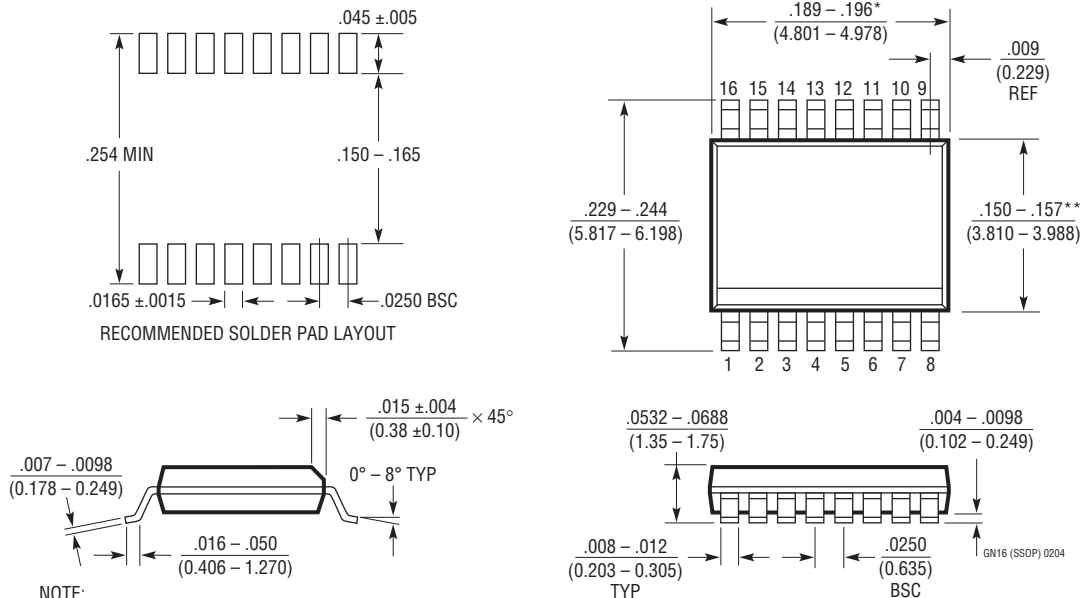

- NOTE:
1. CONTROLLING DIMENSION: INCHES
 2. DIMENSIONS ARE IN $\frac{\text{INCHES}}{\text{(MILLIMETERS)}}$
 3. DRAWING NOT TO SCALE
- * DIMENSION DOES NOT INCLUDE MOLD FLASH. MOLD FLASH SHALL NOT EXCEED 0.006" (0.152mm) PER SIDE
- ** DIMENSION DOES NOT INCLUDE INTERLEAD FLASH. INTERLEAD FLASH SHALL NOT EXCEED 0.010" (0.254mm) PER SIDE

REVISION HISTORY (Revision history begins at Rev D)

REV	DATE	DESCRIPTION	PAGE NUMBER
D	2/11	Obsoleted LTC4253A Revised Application drawings Replaced Shunt Regulator section	2 12, 14, 15, 21, 25 to 32, 34 14
E	3/12	Not recommended for new designs	1
F	1/13	Removed, NOT RECOMMENDED FOR NEW DESIGNS statement	1

LTC4253/LTC4253A

TYPICAL APPLICATION

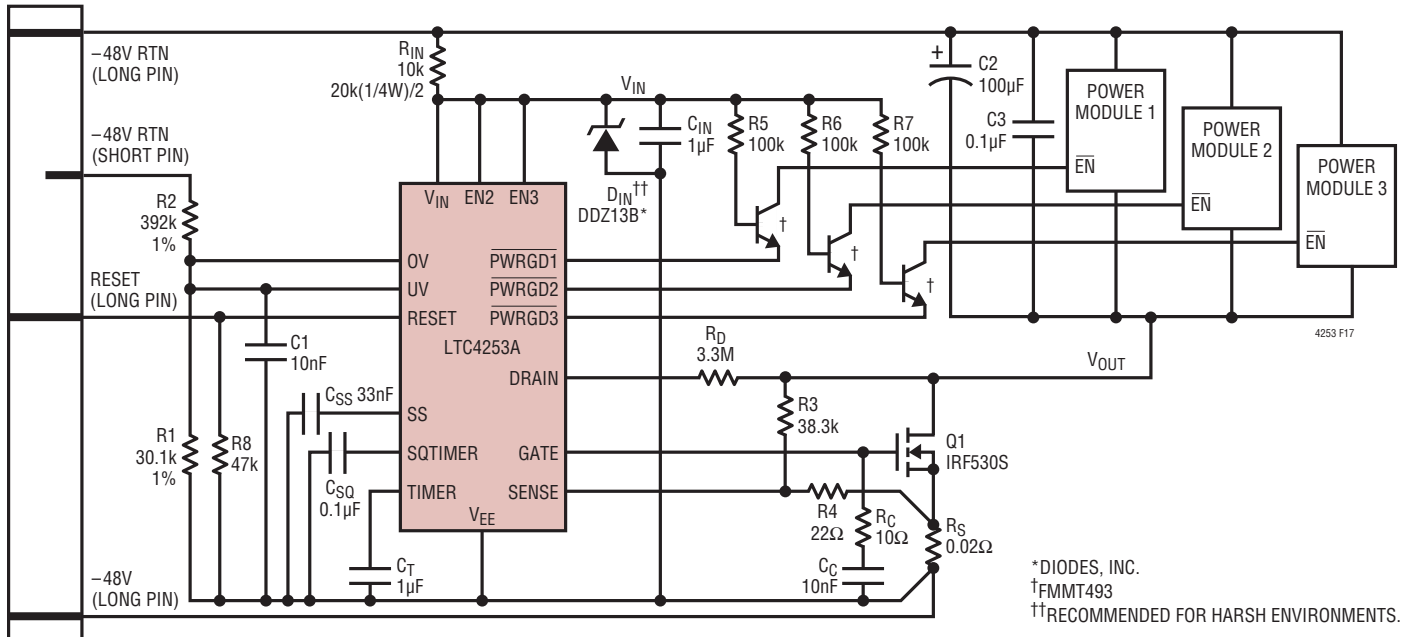

Figure 17. -48V/2.5A Application with Foldback Current Limiting and Transistor Enabled Sequencing without Feedback

RELATED PARTS

PART NUMBER	DESCRIPTION	COMMENTS
LT1640AH/LT1640AL	Negative High Voltage Hot Swap Controllers in SO-8	Negative High Voltage Supplies from -10V to -80V
LT1641-1/LT1641-2	Positive High Voltage Hot Swap Controllers in SO-8	Supplies from 9V to 80V, Autoretry/Latched Off
LTC1642A	Fault Protected Hot Swap Controller	3V to 16.5V, Overvoltage Protection up to 33V
LT4250	-48V Hot Swap Controller	Active Current Limiting, Supplies from -20V to -80V
LTC4251/LTC4251-1/ LTC4251-2	-48V Hot Swap Controllers in SOT-23	Fast Active Current Limiting, Supplies from -15V
LTC4252-1/LTC4252-2 LTC4252A-1/LTC4252A-2	-48V Hot Swap Controllers in MS8/MS10	Fast Active Current Limiting, Supplies from -15V, Drain Accelerated Response, 1% Accurate UV/OV Thresholds

Компания «Life Electronics» занимается поставками электронных компонентов импортного и отечественного производства от производителей и со складов крупных дистрибьюторов Европы, Америки и Азии.

С конца 2013 года компания активно расширяет линейку поставок компонентов по направлению коаксиальный кабель, кварцевые генераторы и конденсаторы (керамические, пленочные, электролитические), за счёт заключения дистрибьюторских договоров

Мы предлагаем:

- Конкурентоспособные цены и скидки постоянным клиентам.
- Специальные условия для постоянных клиентов.
- Подбор аналогов.
- Поставку компонентов в любых объемах, удовлетворяющих вашим потребностям.
- Приемлемые сроки поставки, возможна ускоренная поставка.
- Доставку товара в любую точку России и стран СНГ.
- Комплексную поставку.
- Работу по проектам и поставку образцов.
- Формирование склада под заказчика.
- Сертификаты соответствия на поставляемую продукцию (по желанию клиента).
- Тестирование поставляемой продукции.
- Поставку компонентов, требующих военную и космическую приемку.
- Входной контроль качества.
- Наличие сертификата ISO.

В составе нашей компании организован Конструкторский отдел, призванный помогать разработчикам, и инженерам.

Конструкторский отдел помогает осуществить:

- Регистрацию проекта у производителя компонентов.
- Техническую поддержку проекта.
- Защиту от снятия компонента с производства.
- Оценку стоимости проекта по компонентам.
- Изготовление тестовой платы монтаж и пусконаладочные работы.



Тел: +7 (812) 336 43 04 (многоканальный)
Email: org@lifeelectronics.ru