

MMBT2369L, MMBT2369AL

Switching Transistors

NPN Silicon

Features

- S Prefix for Automotive and Other Applications Requiring Unique Site and Control Change Requirements; AEC-Q101 Qualified and PPAP Capable
- These Devices are Pb-Free, Halogen Free/BFR Free and are RoHS Compliant*

MAXIMUM RATINGS

Rating	Symbol	Value	Unit
Collector-Emitter Voltage	V_{CEO}	15	Vdc
Collector-Emitter Voltage	V_{CES}	40	Vdc
Collector-Base Voltage	V_{CBO}	40	Vdc
Emitter-Base Voltage	V_{EBO}	4.5	Vdc
Collector Current - Continuous	I_C	200	mAdc

THERMAL CHARACTERISTICS

Characteristic	Symbol	Max	Unit
Total Device Dissipation FR-5 Board (Note 1) $T_A = 25^\circ\text{C}$ Derate above 25°C	P_D	225 1.8	mW mW/ $^\circ\text{C}$
Thermal Resistance, Junction-to-Ambient	$R_{\theta JA}$	556	$^\circ\text{C}/\text{W}$
Total Device Dissipation Alumina Substrate, (Note 2) $T_A = 25^\circ\text{C}$ Derate above 25°C	P_D	300 2.4	mW mW/ $^\circ\text{C}$
Thermal Resistance, Junction-to-Ambient	$R_{\theta JA}$	417	$^\circ\text{C}/\text{W}$
Junction and Storage Temperature	T_J, T_{stg}	-55 to +150	$^\circ\text{C}$

Stresses exceeding those listed in the Maximum Ratings table may damage the device. If any of these limits are exceeded, device functionality should not be assumed, damage may occur and reliability may be affected.

1. FR-5 = $1.0 \times 0.75 \times 0.062$ in.
2. Alumina = $0.4 \times 0.3 \times 0.024$ in. 99.5% alumina.

*For additional information on our Pb-Free strategy and soldering details, please download the ON Semiconductor Soldering and Mounting Techniques Reference Manual, SOLDERRM/D.



ON Semiconductor®

<http://onsemi.com>

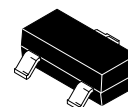

SOT-23
CASE 318
STYLE 6

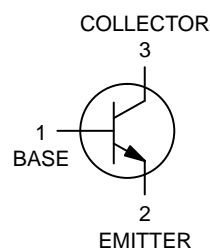

MARKING DIAGRAM

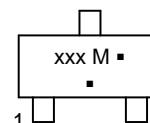

xxx = M1J or 1JA
M = Date Code*
▪ = Pb-Free Package

(Note: Microdot may be in either location)

*Date Code orientation and/or overbar may vary depending upon manufacturing location.

ORDERING INFORMATION

Device	Package	Shipping†
MMBT2369LT1G	SOT-23 (Pb-Free)	3,000 / Tape & Reel
SMMBT2369LT1G	SOT-23 (Pb-Free)	3,000 / Tape & Reel
MMBT2369ALT1G	SOT-23 (Pb-Free)	3,000 / Tape & Reel
SMMBT2369ALT1G	SOT-23 (Pb-Free)	3,000 / Tape & Reel

†For information on tape and reel specifications, including part orientation and tape sizes, please refer to our Tape and Reel Packaging Specifications Brochure, BRD8011/D.

MMBT2369L, MMBT2369AL

ELECTRICAL CHARACTERISTICS (T_A = 25°C unless otherwise noted)

Characteristic	Symbol	Min	Typ	Max	Unit
OFF CHARACTERISTICS					
Collector–Emitter Breakdown Voltage (Note 3) (I _C = 10 mAdc, I _B = 0)	V _{(BR)CEO}	15	–	–	Vdc
Collector–Emitter Breakdown Voltage (I _C = 10 μAdc, V _{BE} = 0)	V _{(BR)CES}	40	–	–	Vdc
Collector–Base Breakdown Voltage (I _C = 10 μAdc, I _E = 0)	V _{(BR)CBO}	40	–	–	Vdc
Emitter–Base Breakdown Voltage (I _E = 10 μAdc, I _C = 0)	V _{(BR)EBO}	4.5	–	–	Vdc
Collector Cutoff Current (V _{CB} = 20 Vdc, I _E = 0) (V _{CB} = 20 Vdc, I _E = 0, T _A = 150°C)	I _{CBO}	– –	– –	0.4 30	μAdc
Collector Cutoff Current MMBT2369A (V _{CE} = 20 Vdc, V _{BE} = 0)	I _{CES}	–	–	0.4	μAdc

ON CHARACTERISTICS

DC Current Gain (Note 3) MMBT2369 (I _C = 10 mAdc, V _{CE} = 1.0 Vdc) MMBT2369A (I _C = 10 mAdc, V _{CE} = 1.0 Vdc) MMBT2369A (I _C = 10 mAdc, V _{CE} = 0.35 Vdc) MMBT2369A (I _C = 10 mAdc, V _{CE} = 0.35 Vdc, T _A = –55°C) MMBT2369A (I _C = 30 mAdc, V _{CE} = 0.4 Vdc) MMBT2369 (I _C = 100 mAdc, V _{CE} = 2.0 Vdc) MMBT2369A (I _C = 100 mAdc, V _{CE} = 1.0 Vdc)	h _{FE}	40 – 40 20 30 20 20	– – – – – – –	120 120 – – – – –	–
Collector–Emitter Saturation Voltage (Note 3) MMBT2369 (I _C = 10 mAdc, I _B = 1.0 mAdc) MMBT2369A (I _C = 10 mAdc, I _B = 1.0 mAdc) MMBT2369A (I _C = 10 mAdc, I _B = 1.0 mAdc, T _A = +125°C) MMBT2369A (I _C = 30 mAdc, I _B = 3.0 mAdc) MMBT2369A (I _C = 100 mAdc, I _B = 10 mAdc)	V _{CE(sat)}	– – – – –	– – – – –	0.25 0.20 0.30 0.25 0.50	Vdc
Base–Emitter Saturation Voltage (Note 3) MMBT2369/A (I _C = 10 mAdc, I _B = 1.0 mAdc) MMBT2369A (I _C = 10 mAdc, I _B = 1.0 mAdc, T _A = –55°C) MMBT2369A (I _C = 30 mAdc, I _B = 3.0 mAdc) MMBT2369A (I _C = 100 mAdc, I _B = 10 mAdc)	V _{BE(sat)}	0.7 – – –	– – – –	0.85 1.02 1.15 1.60	Vdc

SMALL–SIGNAL CHARACTERISTICS

Output Capacitance (V _{CB} = 5.0 Vdc, I _E = 0, f = 1.0 MHz)	C _{obo}	–	–	4.0	pF
Small Signal Current Gain (I _C = 10 mAdc, V _{CE} = 10 Vdc, f = 100 MHz)	h _{fe}	5.0	–	–	–

SWITCHING CHARACTERISTICS

Storage Time (I _{B1} = I _{B2} = I _C = 10 mAdc)	t _s	–	5.0	13	ns
Turn–On Time (V _{CC} = 3.0 Vdc, I _C = 10 mAdc, I _{B1} = 3.0 mAdc)	t _{on}	–	8.0	12	ns
Turn–Off Time (V _{CC} = 3.0 Vdc, I _C = 10 mAdc, I _{B1} = 3.0 mAdc, I _{B2} = 1.5 mAdc)	t _{off}	–	10	18	ns

Product parametric performance is indicated in the Electrical Characteristics for the listed test conditions, unless otherwise noted. Product performance may not be indicated by the Electrical Characteristics if operated under different conditions.

3. Pulse Test: Pulse Width ≤ 300 μs, Duty Cycle ≤ 2.0%.

MMBT2369L, MMBT2369AL

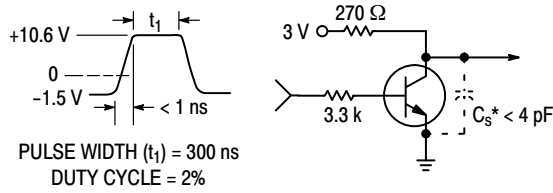

Figure 1. t_{on} Circuit – 10 mA

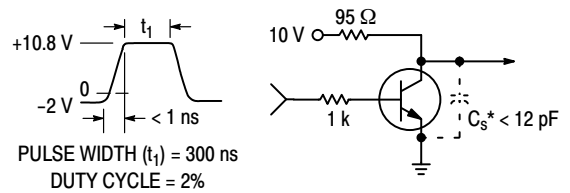

Figure 2. t_{on} Circuit – 100 mA

*Total shunt capacitance of test jig and connectors.

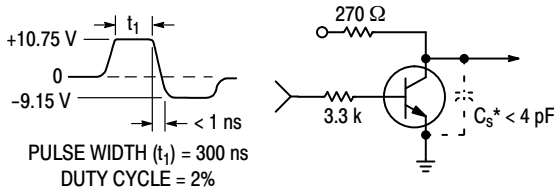

Figure 3. t_{off} Circuit – 10 mA

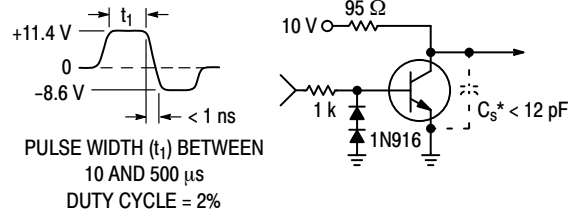
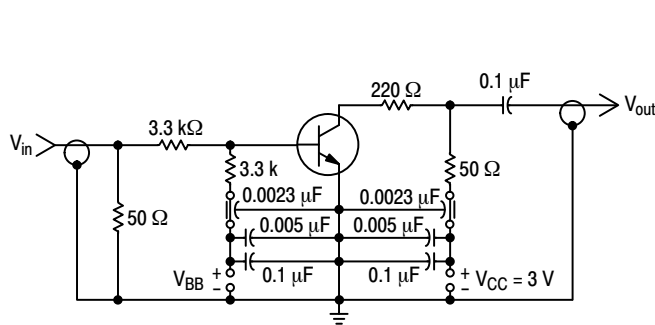
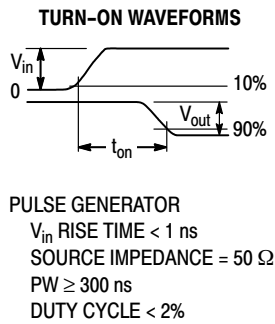

Figure 4. t_{off} Circuit – 100 mA

*Total shunt capacitance of test jig and connectors.



TO OSCILLOSCOPE
INPUT IMPEDANCE = 50 Ω
RISE TIME = 1 ns

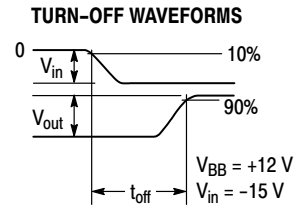

Figure 5. Turn-On and Turn-Off Time Test Circuit

MMBT2369L, MMBT2369AL

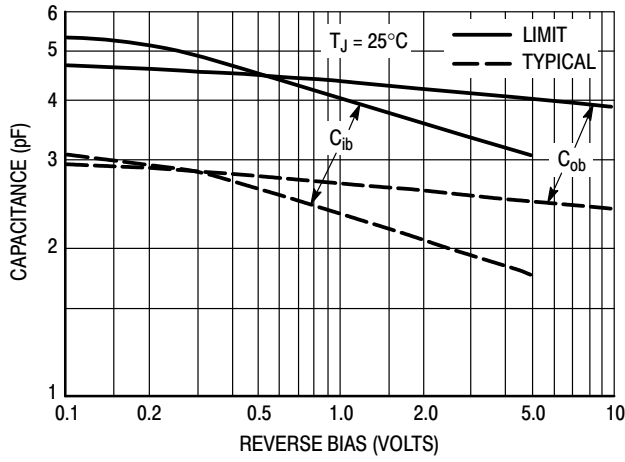

Figure 6. Junction Capacitance Variations

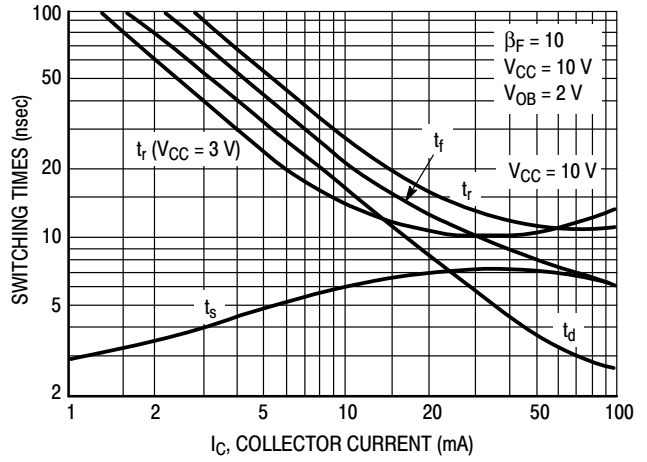

Figure 7. Typical Switching Times

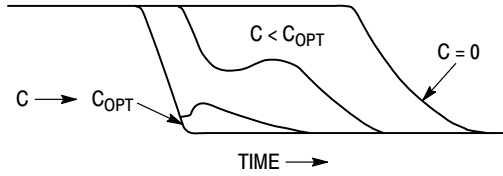

Figure 8. Turn-Off Waveform

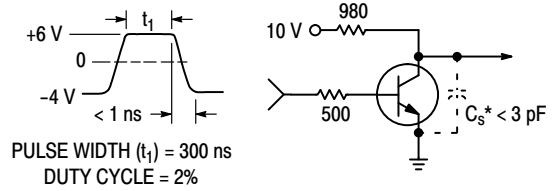

Figure 9. Storage Time Equivalent Test Circuit

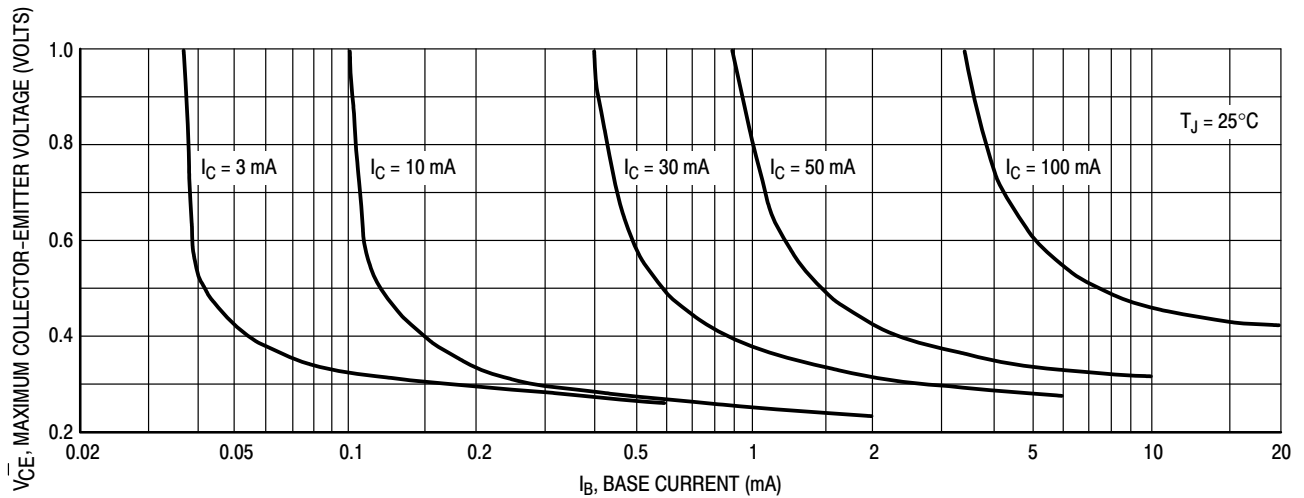

Figure 10. Maximum Collector Saturation Voltage Characteristics

MMBT2369L, MMBT2369AL

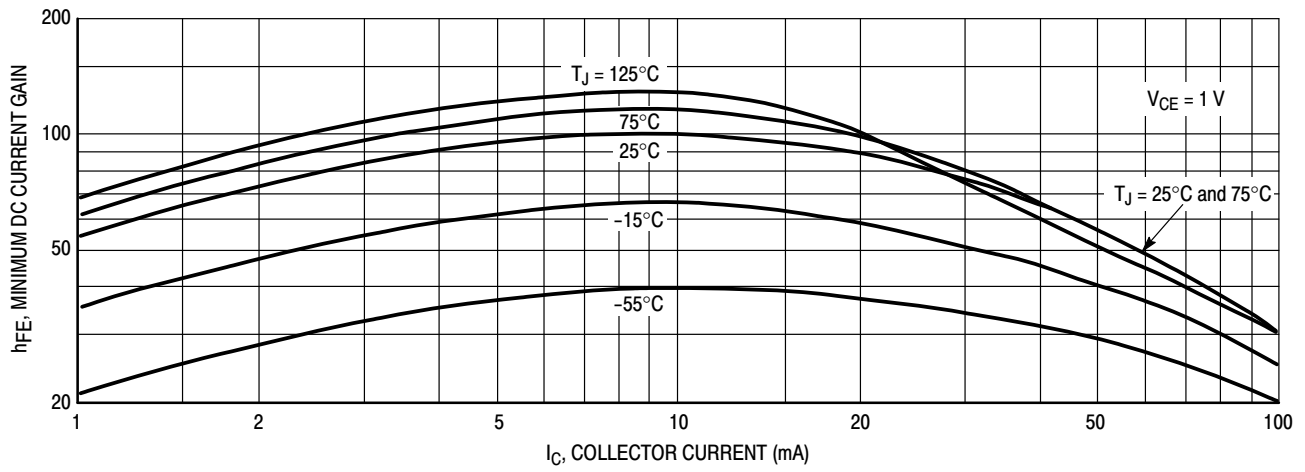

Figure 11. Minimum Current Gain Characteristics

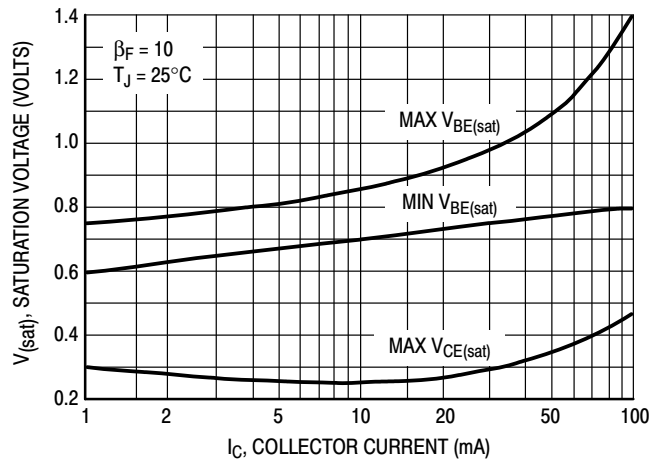
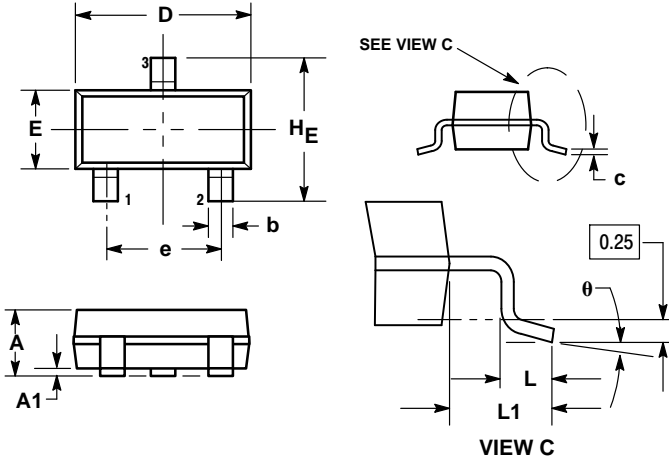

Figure 12. Saturation Voltage Limits

MMBT2369L, MMBT2369AL

PACKAGE DIMENSIONS

SOT-23 (TO-236)
CASE 318-08
ISSUE AP



NOTES:

1. DIMENSIONING AND TOLERANCING PER ANSI Y14.5M, 1982.
2. CONTROLLING DIMENSION: INCH.
3. MAXIMUM LEAD THICKNESS INCLUDES LEAD FINISH THICKNESS. MINIMUM LEAD THICKNESS IS THE MINIMUM THICKNESS OF BASE MATERIAL.
4. DIMENSIONS D AND E DO NOT INCLUDE MOLD FLASH, PROTRUSIONS, OR GATE BURRS.

DIM	MILLIMETERS			INCHES		
	MIN	NOM	MAX	MIN	NOM	MAX
A	0.89	1.00	1.11	0.035	0.040	0.044
A1	0.01	0.06	0.10	0.001	0.002	0.004
b	0.37	0.44	0.50	0.015	0.018	0.020
c	0.09	0.13	0.18	0.003	0.005	0.007
D	2.80	2.90	3.04	0.110	0.114	0.120
E	1.20	1.30	1.40	0.047	0.051	0.055
e	1.78	1.90	2.04	0.070	0.075	0.081
L	0.10	0.20	0.30	0.004	0.008	0.012
L1	0.35	0.54	0.69	0.014	0.021	0.029
HE	2.10	2.40	2.64	0.083	0.094	0.104
θ	0°	---	10°	0°	---	10°

STYLE 6:

1. BASE
2. EMITTER
3. COLLECTOR

SOLDERING FOOTPRINT

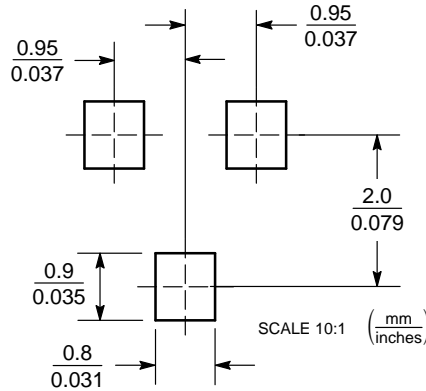

ON Semiconductor and  are registered trademarks of Semiconductor Components Industries, LLC (SCILLC). SCILLC reserves the right to make changes without further notice to any products herein. SCILLC makes no warranty, representation or guarantee regarding the suitability of its products for any particular purpose, nor does SCILLC assume any liability arising out of the application or use of any product or circuit, and specifically disclaims any and all liability, including without limitation special, consequential or incidental damages. "Typical" parameters which may be provided in SCILLC data sheets and/or specifications can and do vary in different applications and actual performance may vary over time. All operating parameters, including "Typicals" must be validated for each customer application by customer's technical experts. SCILLC does not convey any license under its patent rights nor the rights of others. SCILLC products are not designed, intended, or authorized for use as components in systems intended for surgical implant into the body, or other applications intended to support or sustain life, or for any other application in which the failure of the SCILLC product could create a situation where personal injury or death may occur. Should Buyer purchase or use SCILLC products for any such unintended or unauthorized application, Buyer shall indemnify and hold SCILLC and its officers, employees, subsidiaries, affiliates, and distributors harmless against all claims, costs, damages, and expenses, and reasonable attorney fees arising out of, directly or indirectly, any claim of personal injury or death associated with such unintended or unauthorized use, even if such claim alleges that SCILLC was negligent regarding the design or manufacture of the part. SCILLC is an Equal Opportunity/Affirmative Action Employer. This literature is subject to all applicable copyright laws and is not for resale in any manner.

PUBLICATION ORDERING INFORMATION

LITERATURE FULFILLMENT:

Literature Distribution Center for ON Semiconductor
P.O. Box 5163, Denver, Colorado 80217 USA
Phone: 303-675-2175 or 800-344-3860 Toll Free USA/Canada
Fax: 303-675-2176 or 800-344-3867 Toll Free USA/Canada
Email: orderlit@onsemi.com

N. American Technical Support: 800-282-9855 Toll Free
USA/Canada
Europe, Middle East and Africa Technical Support:
Phone: 421 33 790 2910
Japan Customer Focus Center
Phone: 81-3-5817-1050

ON Semiconductor Website: www.onsemi.com

Order Literature: <http://www.onsemi.com/orderlit>

For additional information, please contact your local Sales Representative

MMBT2369LT1/D

Компания «Life Electronics» занимается поставками электронных компонентов импортного и отечественного производства от производителей и со складов крупных дистрибьюторов Европы, Америки и Азии.

С конца 2013 года компания активно расширяет линейку поставок компонентов по направлению коаксиальный кабель, кварцевые генераторы и конденсаторы (керамические, пленочные, электролитические), за счёт заключения дистрибьюторских договоров

Мы предлагаем:

- Конкурентоспособные цены и скидки постоянным клиентам.
- Специальные условия для постоянных клиентов.
- Подбор аналогов.
- Поставку компонентов в любых объемах, удовлетворяющих вашим потребностям.
- Приемлемые сроки поставки, возможна ускоренная поставка.
- Доставку товара в любую точку России и стран СНГ.
- Комплексную поставку.
- Работу по проектам и поставку образцов.
- Формирование склада под заказчика.
- Сертификаты соответствия на поставляемую продукцию (по желанию клиента).
- Тестирование поставляемой продукции.
- Поставку компонентов, требующих военную и космическую приемку.
- Входной контроль качества.
- Наличие сертификата ISO.

В составе нашей компании организован Конструкторский отдел, призванный помогать разработчикам, и инженерам.

Конструкторский отдел помогает осуществить:

- Регистрацию проекта у производителя компонентов.
- Техническую поддержку проекта.
- Защиту от снятия компонента с производства.
- Оценку стоимости проекта по компонентам.
- Изготовление тестовой платы монтаж и пусконаладочные работы.



Тел: +7 (812) 336 43 04 (многоканальный)

Email: org@lifeelectronics.ru