

LOC		DIST		REVISIONS			
P	LTN	DESCRIPTION	DATE	DMN	APVD		
GP	00						
E2		ADDED NEW DASH NUMBER 2-5	03MAY2012	CZ	SZ		
E3		REVISED	16FEB2013	ML	SZ		
E4		ADD NEW DASH NUMBER 2-6	09MAY2014	CZ	SZ		

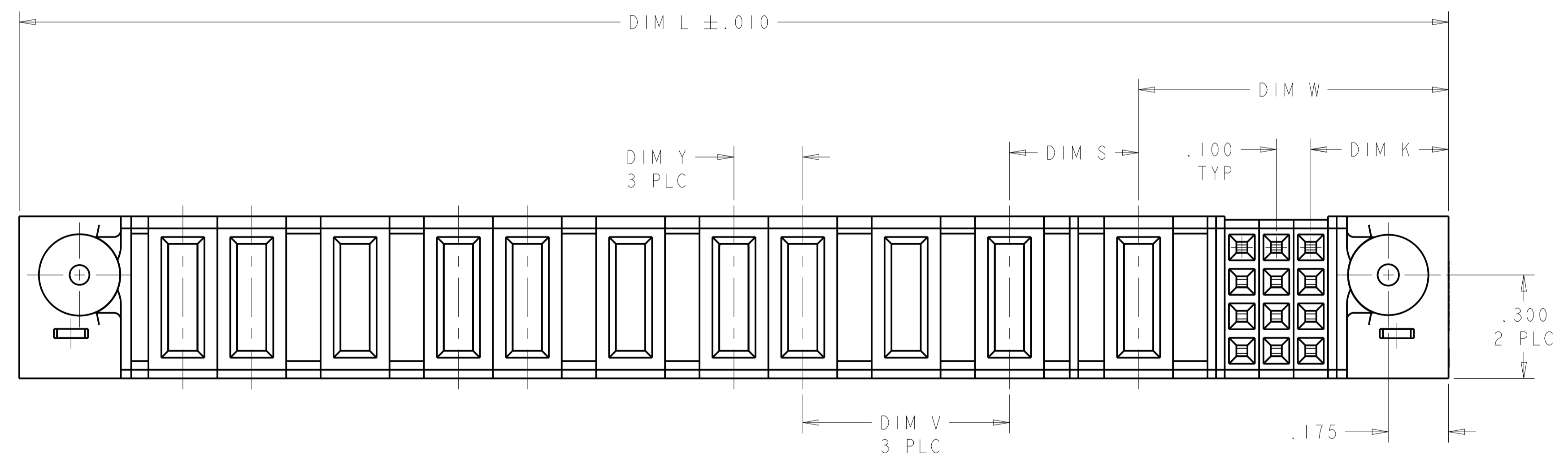

- 1 "AMP", PART NUMBER, AND DATE CODE TO BE MARKED IN AREA SHOWN.
- 2 MATERIAL: HOUSING - GLASS FILLED HIGH TEMP THERMO PLASTIC, UL94 V-O.
SIGNAL CONTACT - HIGH CONDUCTIVITY COPPER ALLOY
POWER CONTACT - HIGH CONDUCTIVITY COPPER ALLOY
- 3 CONTACT PLATING: NOBLE METAL PLATED ON THE CONTACT FUNCTIONAL AREA OF POWER AND SIGNAL CONTACTS.
- 4 MECHANICAL CONNECTOR KEEP OUT ZONE.
- 5 DATUM AND BASIC DIMENSIONS ESTABLISHED BY CUSTOMER.
- 6 PCB - ALL HOLE DIAMETERS ARE FINISHED HOLE SIZES.
- 7 PCB - .0453 +/- .0010 DRILLED HOLES PLATED WITH .0003 MIN Sn OVER .001 TO .003 PLATING TO ACHIEVE A .040 DIA. HOLE.
- 8 FOR DETAIL DIM PLEASE REFER TO TABLE

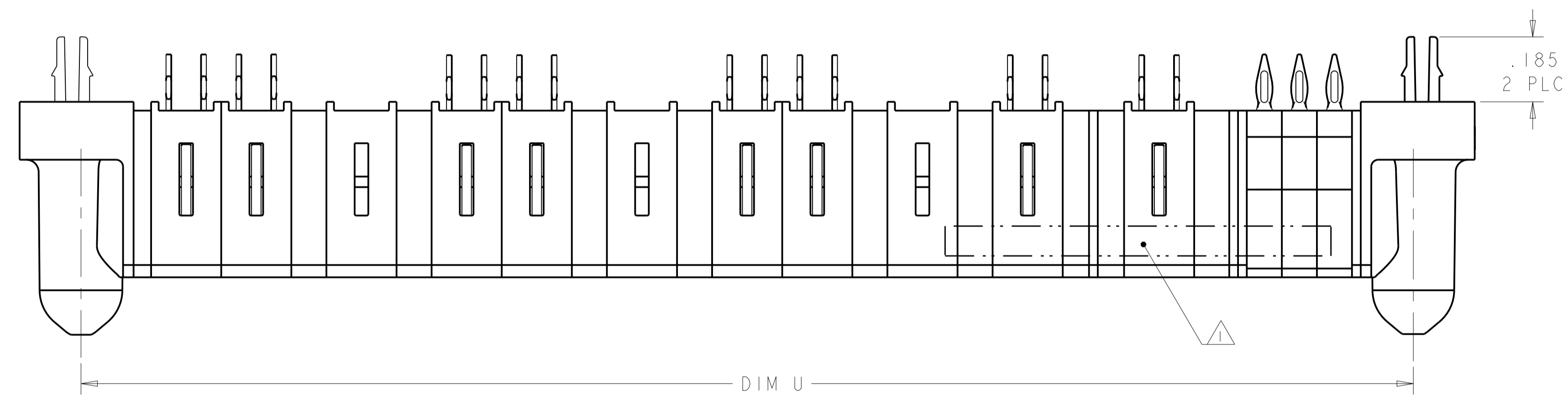
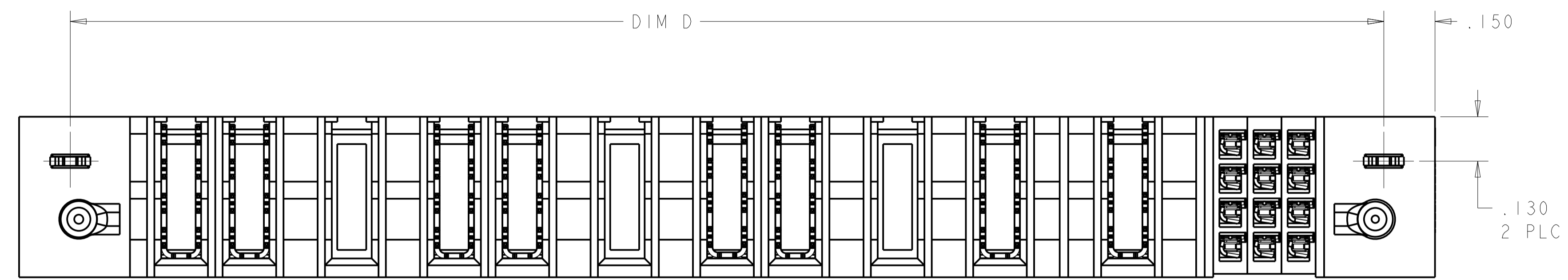
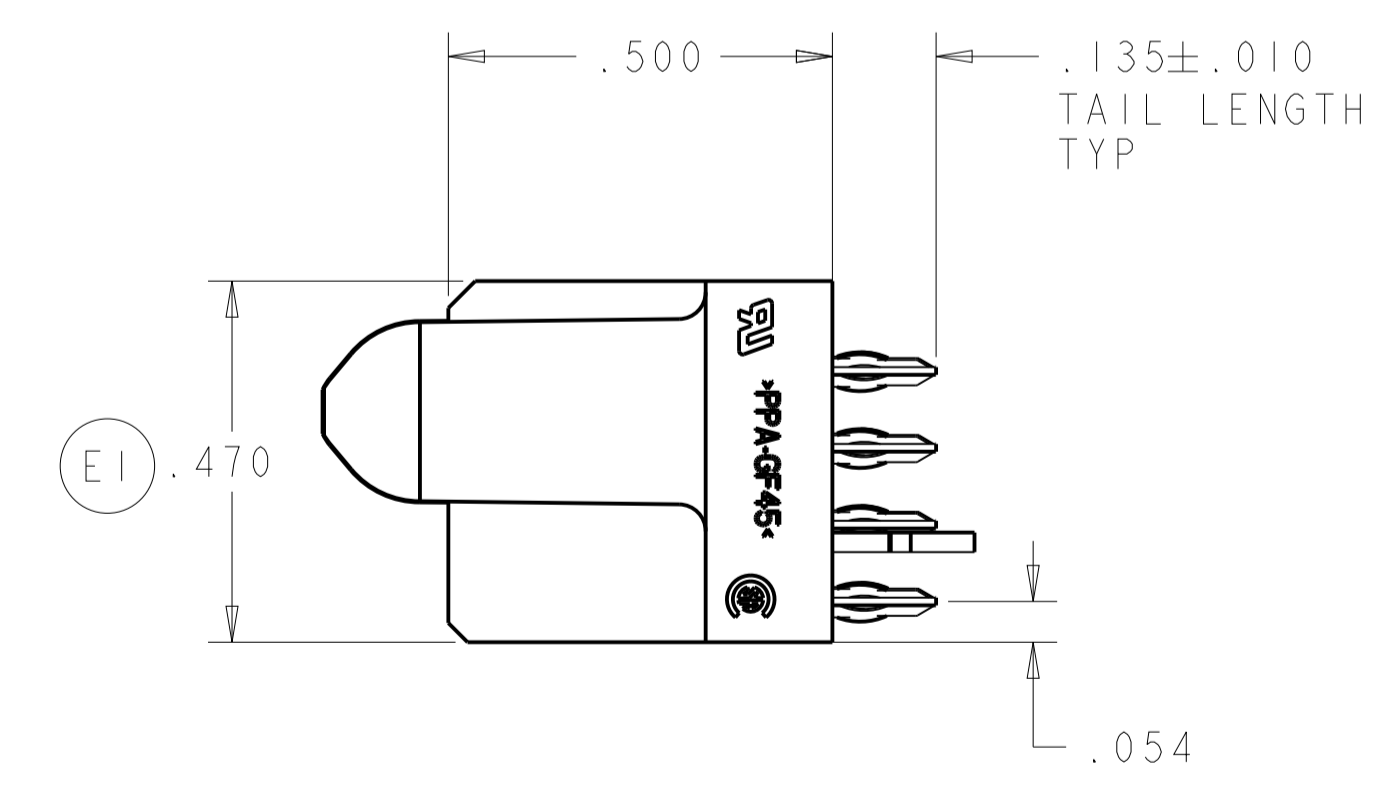

THIS DRAWING IS A CONTROLLED DOCUMENT.		DMN R. GRZYBOWSKI 02MAY05	TE Connectivity NAME VERTICAL RECEPTACLE WITH GUIDES MULTI-BEAM XL	
DIMENSIONS: INCHES		CHK M. PERCHERKE 02MAY05		
TOLERANCES UNLESS OTHERWISE SPECIFIED:		APVD M. PERCHERKE 02MAY05	PRODUCT SPEC	
0 PLC ±. 1 PLC ±.01 2 PLC ±.01 3 PLC ±.005 4 PLC ±.0020 ANGLES ±.2°		108-1973	APPLICATION SPEC	
MATERIAL		114-13038	RESTRICTED TO	
FINISH		3	SIZE CAGE CODE DRAWING NO	
CUSTOMER DRAWING		SCALE 4:1	SHEET 1 OF 12 REV E.4	

THIS DRAWING IS UNPUBLISHED. RELEASED FOR PUBLICATION 20
 © COPYRIGHT 20 BY - ALL RIGHTS RESERVED.

LOC		DIST		REVISIONS			
GP	00	P	LTN	DESCRIPTION	DATE	DWN	APVD
-	-	-	-	SEE SHEET 1	-	-	-
-	-	-	-				
-	-	-	-				

E4	-	-	2.400	.250	.375	2.750	1.050	2.450	24S + 6P	2-6450541-6
	-	-	-	-	.425	2.350	-	2.050	64S	2-6450541-5
	-	-	1.100	-	.375	1.450	-	1.150	32S	2-6450541-4
	-	-	3.800	.250	.375	4.150	3.450	3.850	120S + 2P	2-6450541-3
	-	-	1.500	.250	.375	1.850	0.625	1.550	8S + 4P	2-6450541-2
	-	-	1.600	.250	.375	1.950	0.725	1.650	12S + 4P	2-6450541-1
	-	-	6.075	.200	.375	6.425	1.375	6.125	36S + 24P	2-6450541-0
	-	-	4.025	$\frac{8}{\Delta}$.375	4.375	2.125	4.075	60S + 8P	1-6450541-9
	-	-	2.925	.200	.375	3.275	1.025	2.975	24S + 10P	1-6450541-8
	-	-	2.400	.250	.375	2.750	1.050	-	24S + 6P	1-6450541-7
	-	-	1.750	.200	.375	2.100	.650	-	8S + 6HDP	1-6450541-4
	-	-	0.950	.200	.375	1.300	.650	-	8S + 2HDP	1-6450541-3
	-	-	1.700	.250	.375	2.050	.850	-	16S + 4P	1-6450541-2
	-	-	2.850	.200	.375	3.200	.950	-	20S + 10HDP	6450541-7
	-	-	2.900	.250	.375	3.250	1.050	-	24S + 8P	6450541-5
	-	-	2.400	.250	.375	2.750	1.050	-	24S + 6P	6450541-4
	-	-	1.900	.250	.375	2.250	1.050	-	24S + 4P	6450541-3
	-	-	4.400	.250	.375	4.750	1.050	-	24S + 14P	6450541-2
	.200	.600	3.800	.375	.400	4.150	.900	3.850	12S + 11P	6450541-1
	DIM Y	DIM V	DIM U	DIM S	DIM K	DIM L	DIM W	DIM D	DESCRIPTION	PART NUMBER

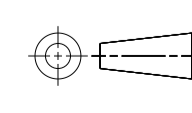
THIS DRAWING IS A CONTROLLED DOCUMENT.		DWN R. GRZYBOWSKI 02MAY05	 TE Connectivity
DIMENSIONS: INCHES		CHK M. PERCHERKE 02MAY05	
TOLERANCES UNLESS OTHERWISE SPECIFIED:		APVD M. PERCHERKE 02MAY05	NAME VERTICAL RECEPTACLE WITH GUIDES MULTI-BEAM XL
 0 PLC ±. 1 PLC ±. 2 PLC ±.01 3 PLC ±.005 4 PLC ±.0020 ANGLES ±.020		PRODUCT SPEC 108-1973	RESTRICTED TO
MATERIAL		APPLICATION SPEC 114-13038	SIZE CAGE CODE DRAWING NO A100779C=6450541
FINISH		WEIGHT	SCALE 4:1 SHEET 2 OF 12 REV E4
		CUSTOMER DRAWING	

LOC	DIST	REV	DATE	BY	APPV
GP	00				

REVISIONS			
REV	DATE	BY	APPV
-	-	-	-
SEE SHEET 1			

ASSY PART NUMBER	ROWS	POWER				SIGNAL						
		P4	P3	P2	PI	6	5	4	3	2	1	
6450541-3	D C B A	GP	GP	GP	GP	AP	AP	AP	AP	AP	AP	AP
		GP	GP	GP	GP	AP	AP	AP	AP	AP	AP	AP
		GP	GP	GP	GP	AP	AP	AP	AP	AP	AP	AP
		GP	GP	GP	GP	AP	AP	AP	AP	AP	AP	AP
24S + 4P												

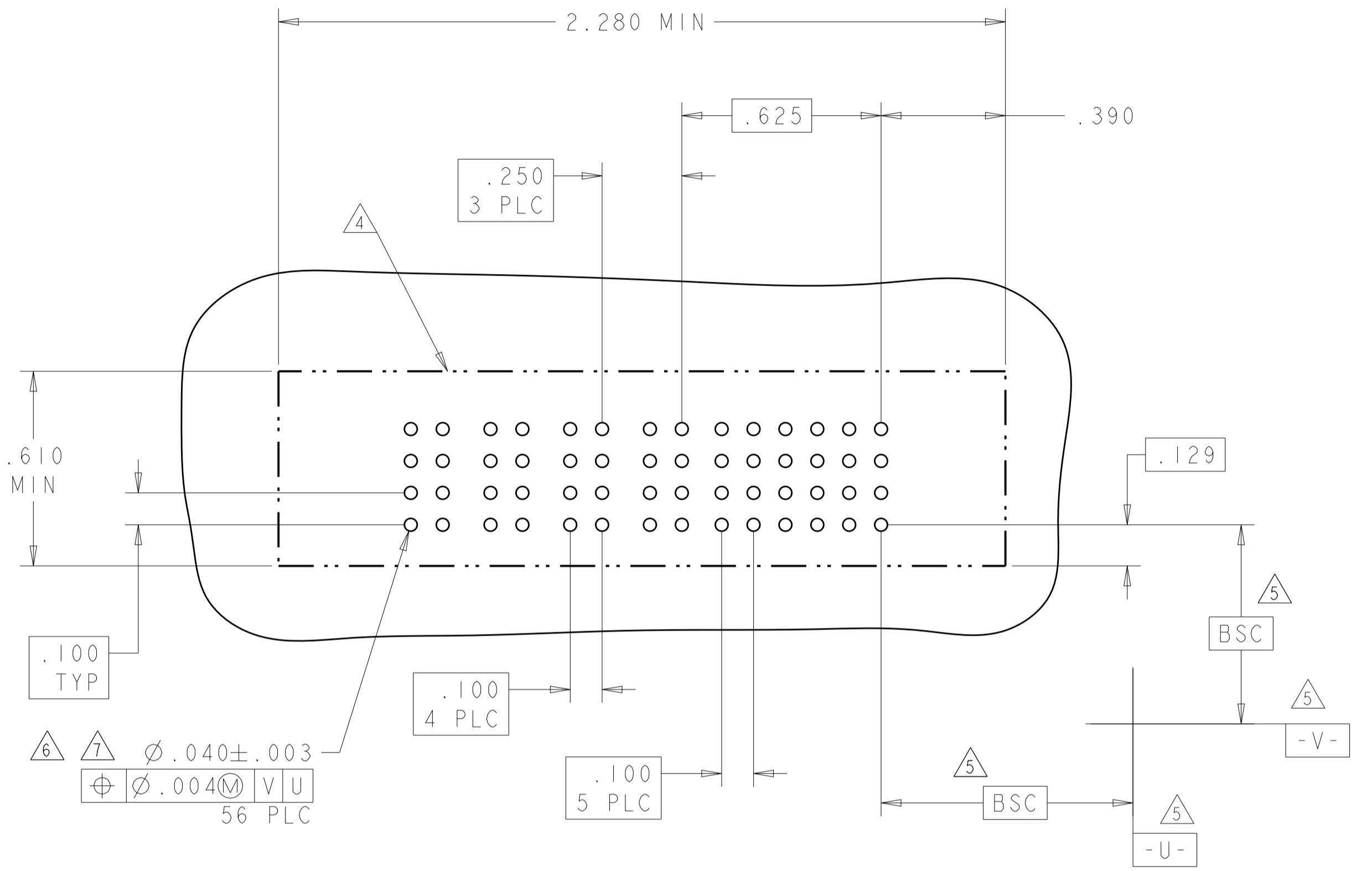

PART NUMBER	ROWS	POWER								SIGNAL					
		P8	P7	P6	P5	P4	P3	P2	PI	6	5	4	3	2	1
6450541-5	D C B A	GP	GP	GP	GP	GP	GP	GP	GP	AP	AP	AP	AP	AP	AP
		GP	GP	GP	GP	GP	GP	GP	GP	AP	AP	AP	AP	AP	AP
		GP	GP	GP	GP	GP	GP	GP	GP	AP	AP	AP	AP	AP	AP
		GP	GP	GP	GP	GP	GP	GP	GP	AP	AP	AP	AP	AP	AP
24S + 8P															

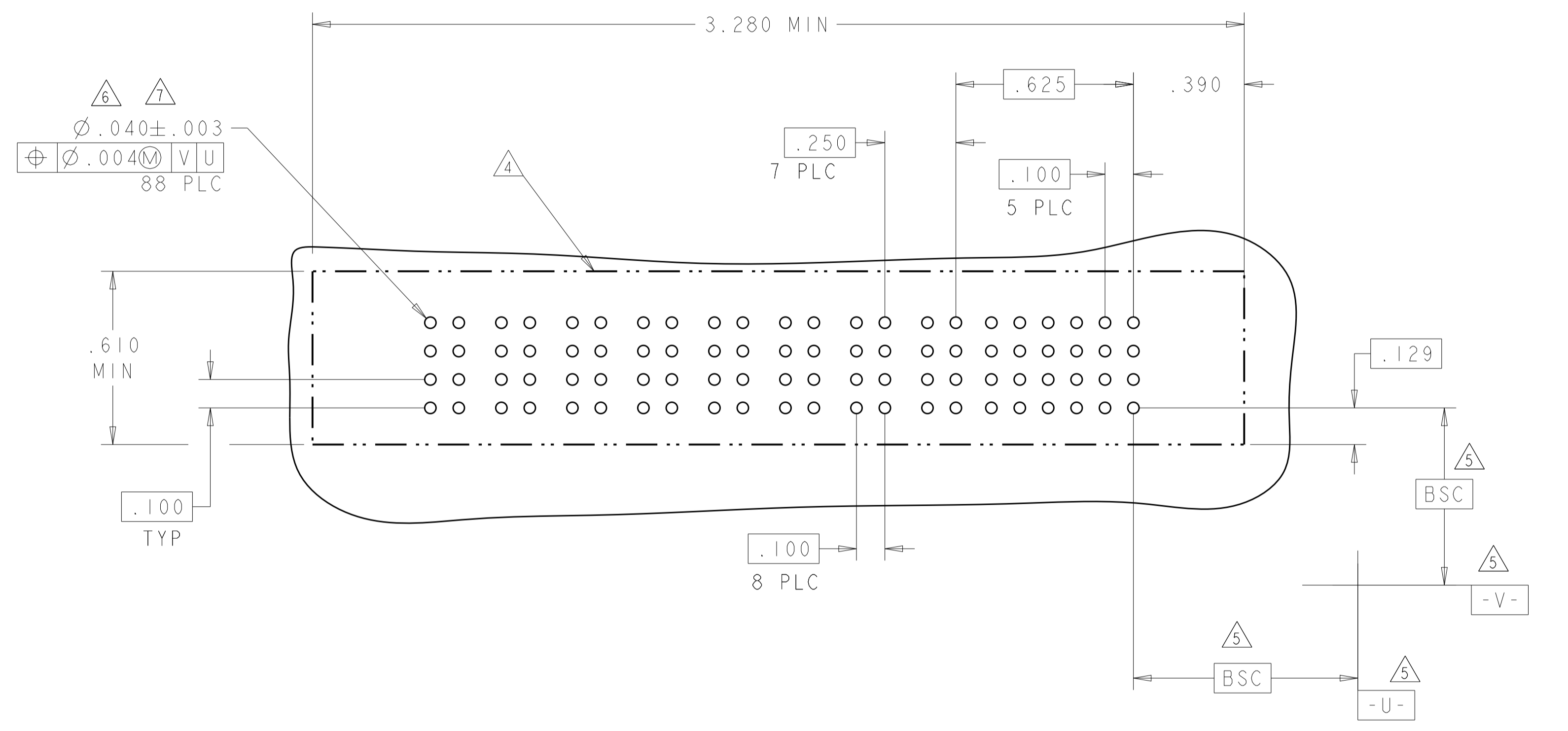

ASSY PART NUMBER	ROWS	POWER						SIGNAL						
		P6	P5	P4	P3	P2	PI	6	5	4	3	2	1	
6450541-4	D C B A	GP	GP	GP	GP	GP	GP	AP	AP	AP	AP	AP	AP	AP
		GP	GP	GP	GP	GP	GP	AP	AP	AP	AP	AP	AP	
		GP	GP	GP	GP	GP	GP	AP	AP	AP	AP	AP	AP	
		GP	GP	GP	GP	GP	GP	AP	AP	AP	AP	AP	AP	
24S + 6P														

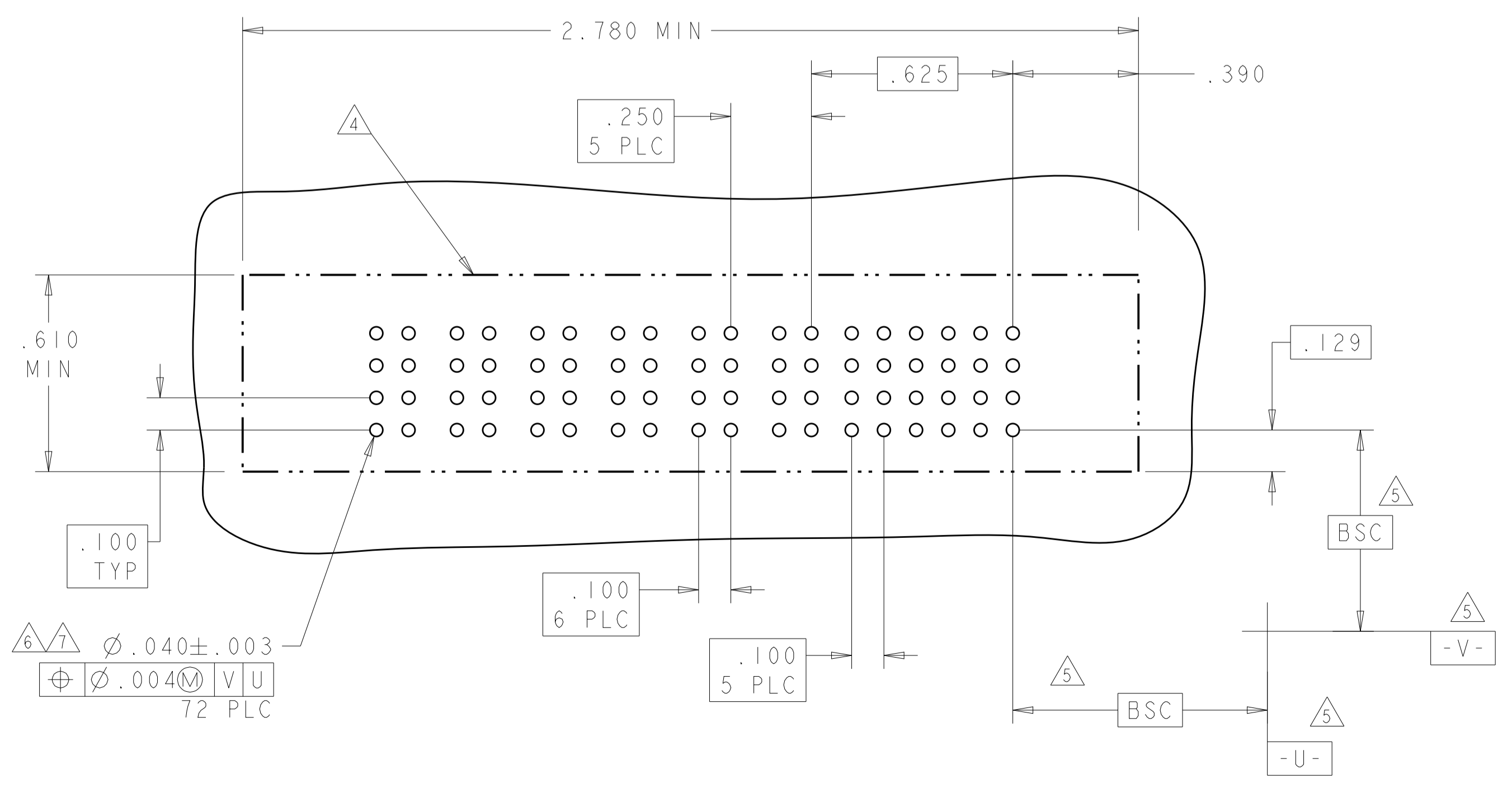

THIS DRAWING IS A CONTROLLED DOCUMENT.

OWN: R. GRZYBOWSKI 02MAY05
 CHK: M. PERCHERKE 02MAY05
 APVD: M. PERCHERKE 02MAY05

STE TE Connectivity

NAME: VERTICAL RECEPTACLE WITH GUIDES MULTI-BEAM XL

PRODUCT SPEC: 108-1973
 APPLICATION SPEC: 114-13038

SIZE: A1 00779 C=6450541
 SCALE: 4:1 SHEET 4 OF 12 REV: E4

MATERIAL: - FINISH: - WEIGHT: -

CUSTOMER DRAWING

PART NUMBER	ROWS	POWER				SIGNAL			
		P4	P3	P2	P1	4	3	2	1
1-6450541-2	D C B A	GS	GS	GS	GS	AP	AP	AP	AP
						AP	AP	AP	AP
						AP	AP	AP	AP
						AP	AP	AP	AP
16S + 4P									

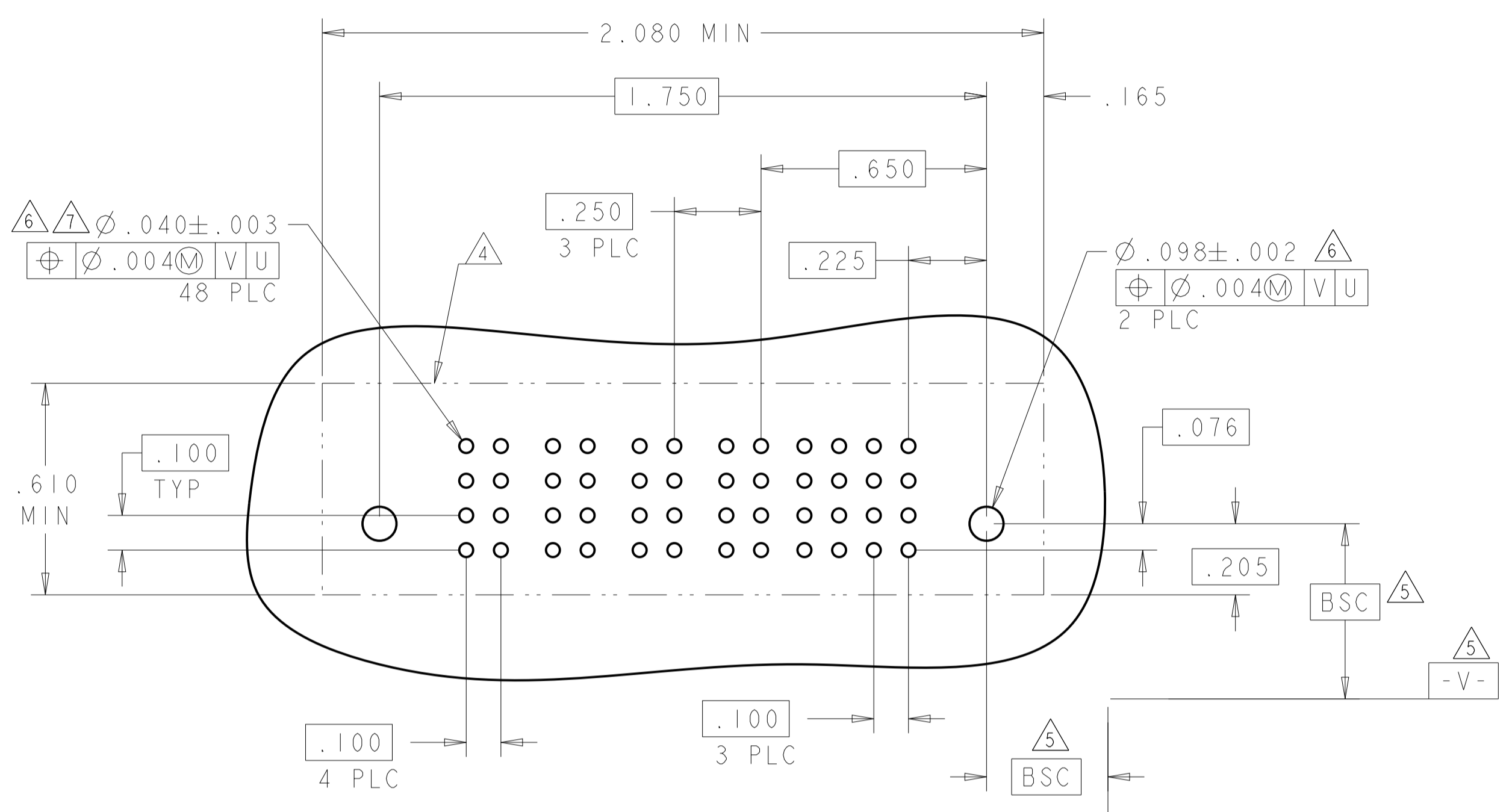

PART NUMBER	ROWS	POWER		SIGNAL	
		P2	P1	2	1
1-6450541-3	D C B A	HS	HS	BP	BP
				BP	BP
				BP	BP
				BP	BP
8S + 2HDP					

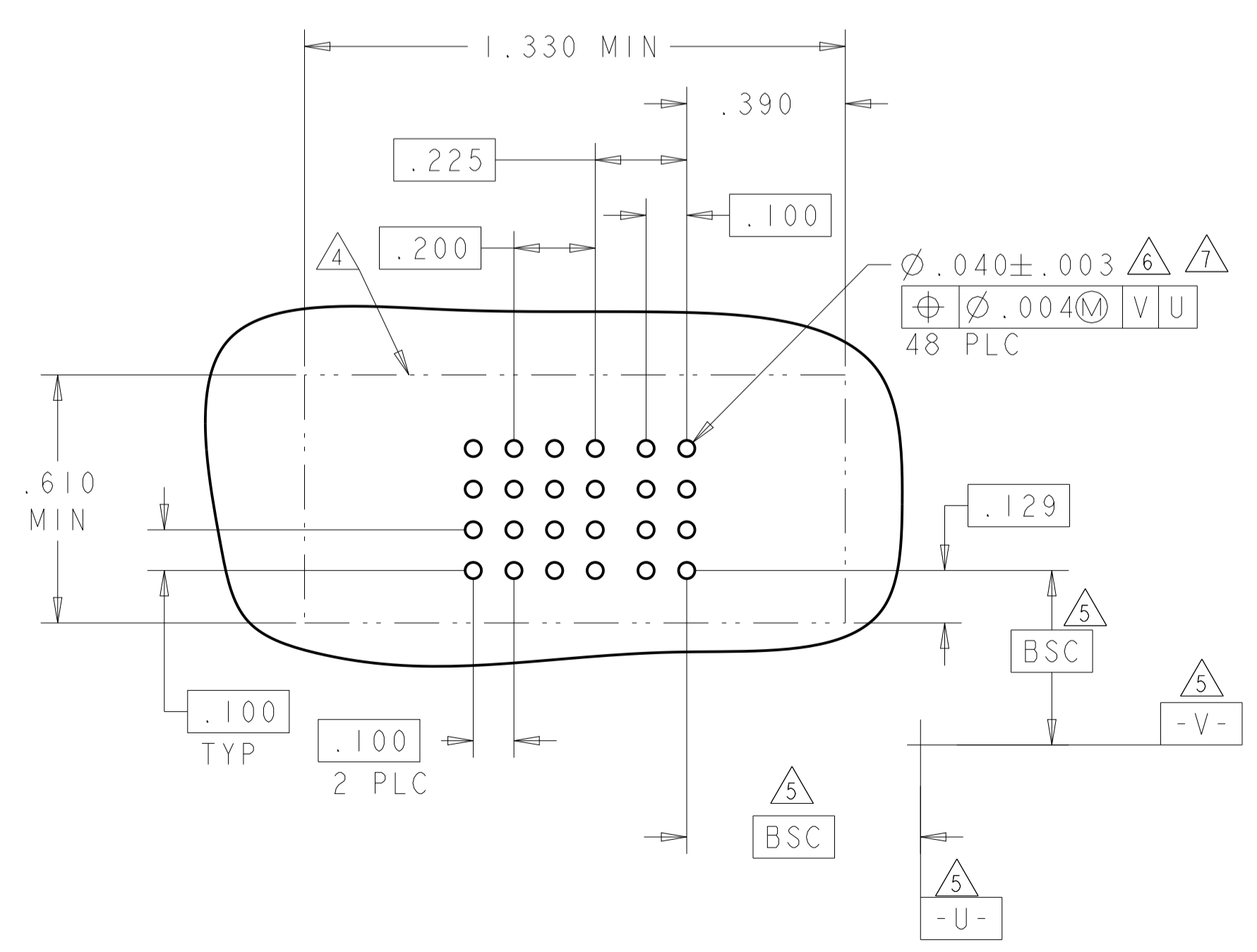

PART NUMBER	ROWS	POWER						SIGNAL	
		P6	P5	P4	P3	P2	P1	2	1
1-6450541-4	D C B A	HS	HS	HS	HS	HS	HS	BP	BP
								BP	BP
								BP	BP
								BP	BP
8S + 6HDP									

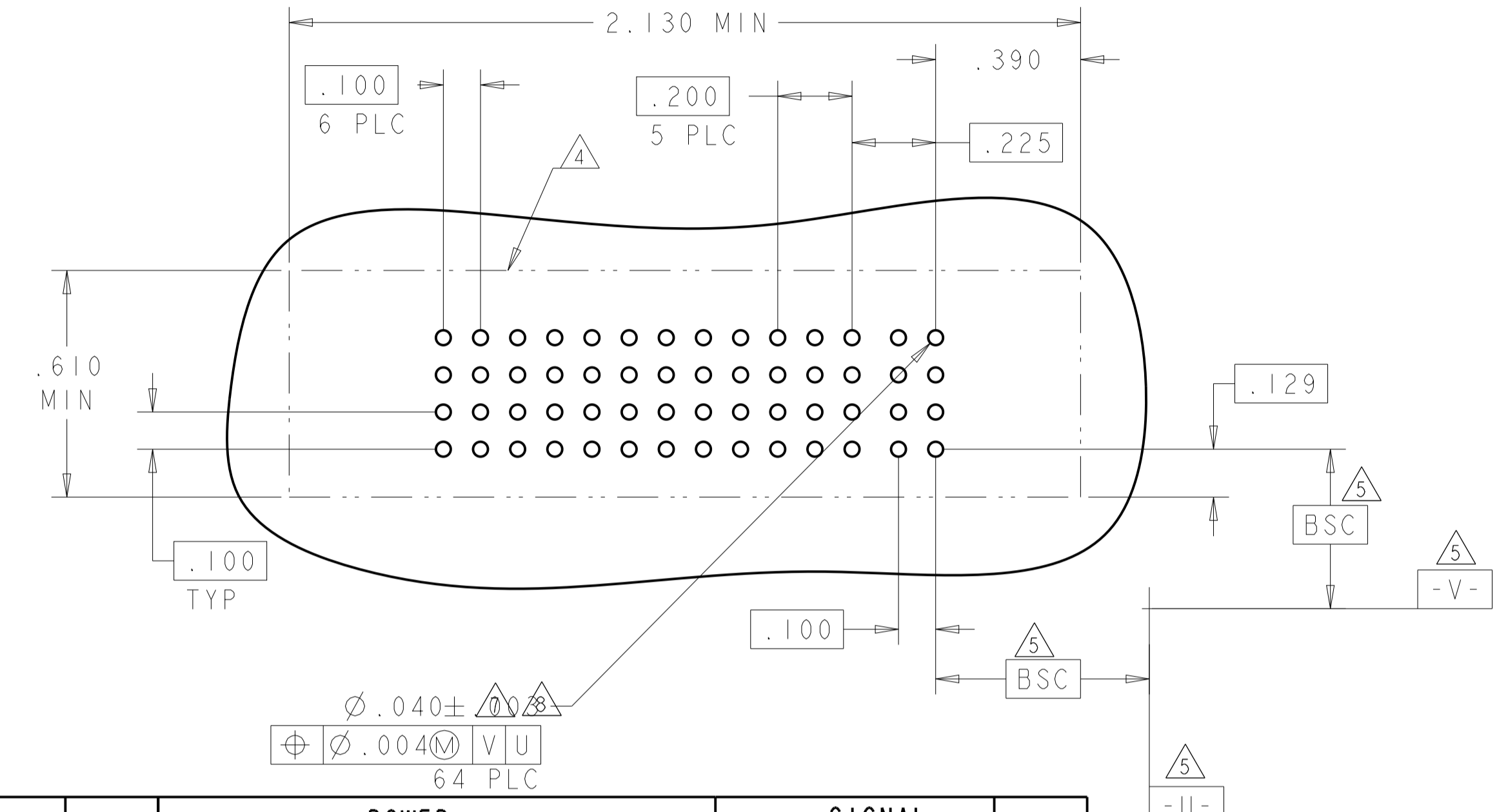

PART NUMBER	ROWS	POWER										SIGNAL								
		P10	P9	P8	P7	P6	P5	P4	P3	P2	P1	5	4	3	2	1				
6450541-7	D C B A	GS	GS	GS	GS	GS	GS	GS	GS	GS	GS	GS	GS	GS	GS	AP	AP	AP	AP	AP
																AP	AP	AP	AP	AP
																AP	AP	AP	AP	AP
																AP	AP	AP	AP	AP
20S + 10HDP																				

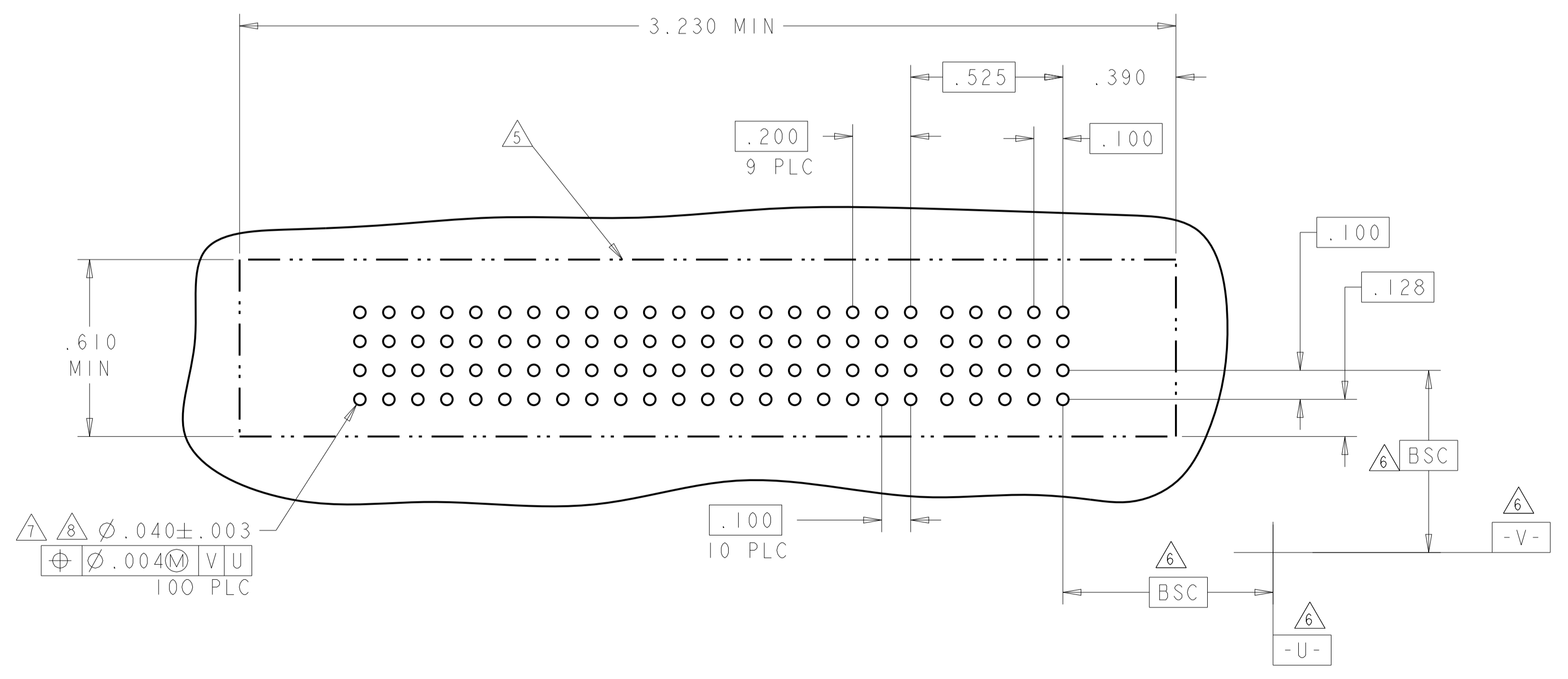

THIS DRAWING IS A CONTROLLED DOCUMENT.

DIMENSIONS:	TOLERANCES UNLESS OTHERWISE SPECIFIED:	OWN: R. GRZYBOWSKI 02MAY05	CHK: M. PERCHERKE 02MAY05		TE Connectivity
INCHES	0 PLC ± 1 PLC ±.01 2 PLC ±.01 3 PLC ±.005 4 PLC ±.002 ANGLES ±.020	APVD: M. PERCHERKE 02MAY05	NAME: VERTICAL RECEPTACLE WITH GUIDES MULTI-BEAM XL		
MATERIAL:	FINISH:	PRODUCT SPEC: 108-1973	APPLICATION SPEC: 114-13038	SIZE: A1	CAGE CODE: 6450541
CUSTOMER DRAWING		SCALE: 4:1	SHEET 5 OF 12	REV: E4	

LOC	DIST	REVISIONS			
P	LTN	DESCRIPTION	DATE	OWN	APVD
GP	00	SEE SHEET 1			

ASSY PART NUMBER	ROWS	POWER						SIGNAL					
		P6	P5	P4	P3	P2	P1	6	5	4	3	2	1
1-6450541-7	D C B A	GS	GS	GS	GS	GS	GS	AP	AP	AP	AP	AP	AP
24S + 6P								AP	AP	AP	AP	AP	AP

PART NUMBER	ROWS	POWER				SIGNAL		
		P4	P3	P2	P1	3	2	1
2-6450541-1	D C B A	GS	GS	GS	GS	AP	AP	AP
12S + 4P						AP	AP	AP

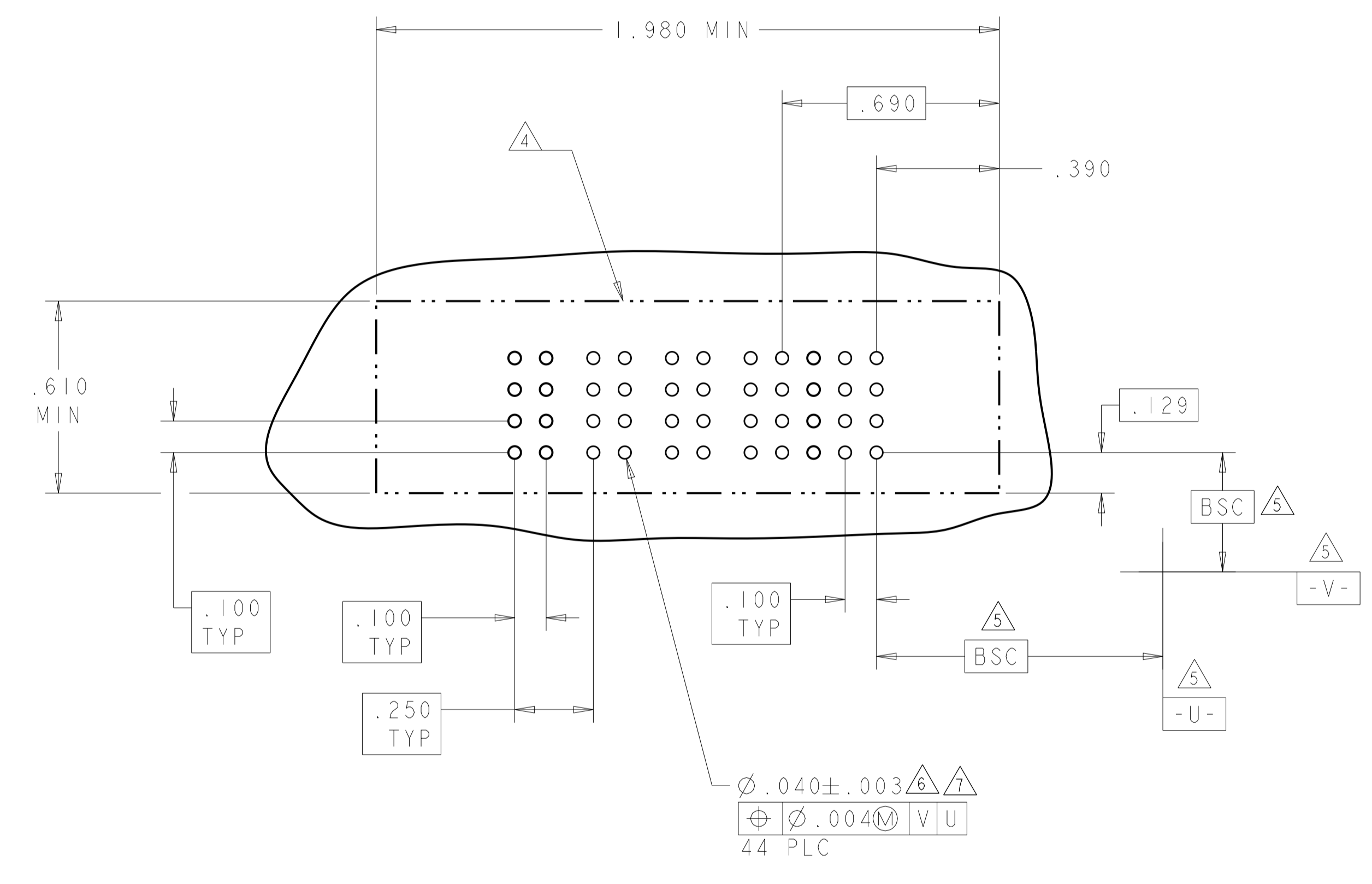
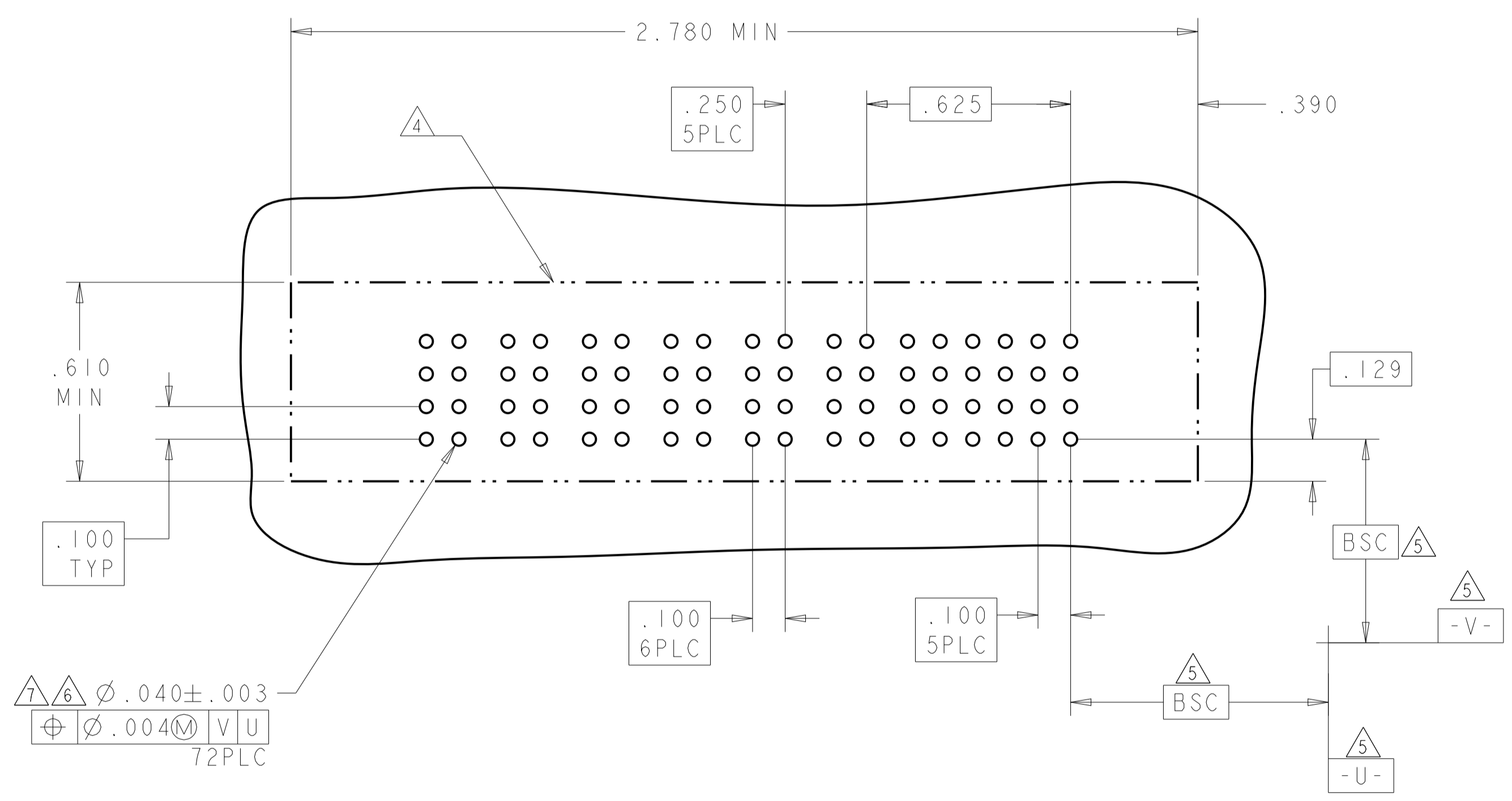

THIS DRAWING IS A CONTROLLED DOCUMENT.

DIMENSIONS: INCHES	TOLERANCES UNLESS OTHERWISE SPECIFIED:	OWN: R. GRZYBOWSKI 02MAY05	CHK: M. PERCHERKE 02MAY05	APVD: M. PERCHERKE 02MAY05	NAME: VERTICAL RECEPTACLE WITH GUIDES MULTI-BEAM XL
0 PLC ±.01	1 PLC ±.01	PRODUCT SPEC: 108-1973	SIZE: CAGE CODE: DRAWING NO: A100779C=6450541		
2 PLC ±.01	3 PLC ±.005	APPLICATION SPEC: 114-13038	RESTRICTED TO: -		
4 PLC ±.0020	ANGLES ±.020	WEIGHT: -	SCALE: 4:1 SHEET 6 OF 12 REV: E4		
MATERIAL: -	FINISH: -	CUSTOMER DRAWING			

4805 (3/11)

LOC	DIST	REVISIONS			
P	LTN	DESCRIPTION	DATE	DWN	APVD
-	-	SEE SHEET 1	-	-	-

ASSY PART NUMBER	ROWS	POWER										SIGNAL							
		P10	P9	P8	P7	P6	P5	P4	P3	P2	P1	6	5	4	3	2	1		
1-6450541-8	D C B A	GS	GS	GS	GS		GS	GS	GS	GS		AP	AP	AP	AP				
												AP	AP	AP	AP				
												AP	AP	AP	AP				
												AP	AP	AP	AP				
24S + 10P																			

NO CONTACTS LOADED

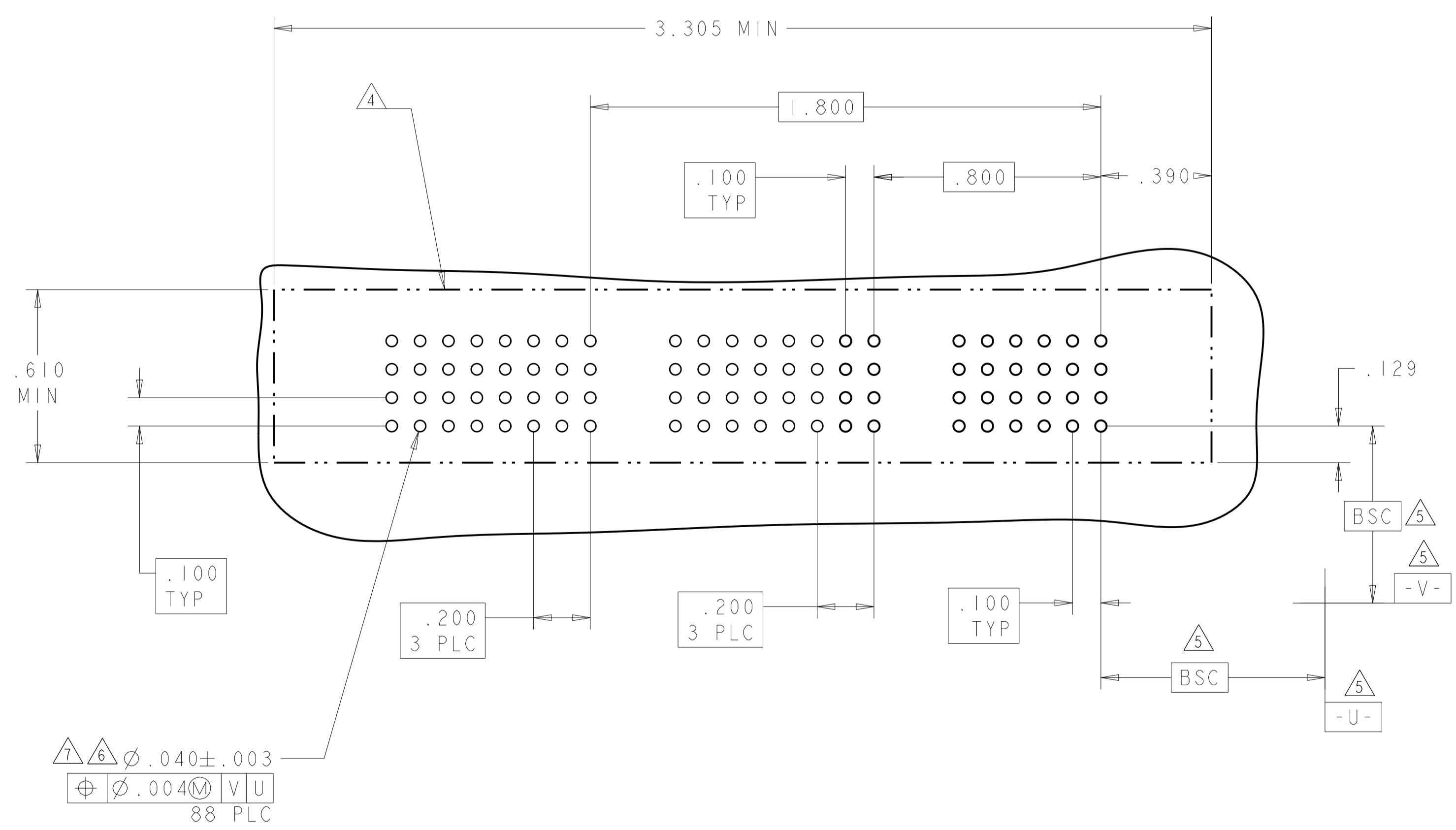

$\Delta \Delta \phi .040 \pm .003$
 $\oplus \phi .004 \text{ V U}$
 88 PLC

THIS DRAWING IS A CONTROLLED DOCUMENT.		DWN R. GRZYBOWSKI 02MAY05	TE Connectivity
DIMENSIONS: INCHES		CHK M. PERCHERKE 02MAY05	
TOLERANCES UNLESS OTHERWISE SPECIFIED: 0 PLC ± 1 PLC ±.01 2 PLC ±.01 3 PLC ±.005 4 PLC ±.0020 ANGLES ±.2°		APVD M. PERCHERKE 02MAY05	NAME VERTICAL RECEPTACLE WITH GUIDES MULTI-BEAM XL
MATERIAL		PRODUCT SPEC 108-1973	SIZE 114-13038
FINISH		APPLICATION SPEC 114-13038	RESTRICTED TO
		WEIGHT	A100779C=6450541
		CUSTOMER DRAWING	SCALE 4:1 SHEET 7 OF 12 REV E4

LOC		DIST		REVISIONS			
GP	00	REV	DATE	BY	CHKD	APVD	DATE
-	-	SEE SHEET 1	-	-	-	-	-

ASSY PART NUMBER	ROWS	POWER								SIGNAL															
		P8	P7	P6	P5	P4	P3	P2	P1	15	14	13	12	11	10	9	8	7	6	5	4	3	2	1	
1-6450541-9	D C B A	GS	GS	GS	GS	GS	GS	GS	GS	AP	AP	AP	AP	AP	AP	AP	AP	AP	AP	AP	AP	AP	AP	AP	AP
		GS	GS	GS	GS	GS	GS	GS	GS	AP	AP	AP	AP	AP	AP	AP	AP	AP	AP	AP	AP	AP	AP	AP	AP
		GS	GS	GS	GS	GS	GS	GS	GS	AP	AP	AP	AP	AP	AP	AP	AP	AP	AP	AP	AP	AP	AP	AP	AP
		GS	GS	GS	GS	GS	GS	GS	GS	AP	AP	AP	AP	AP	AP	AP	AP	AP	AP	AP	AP	AP	AP	AP	AP

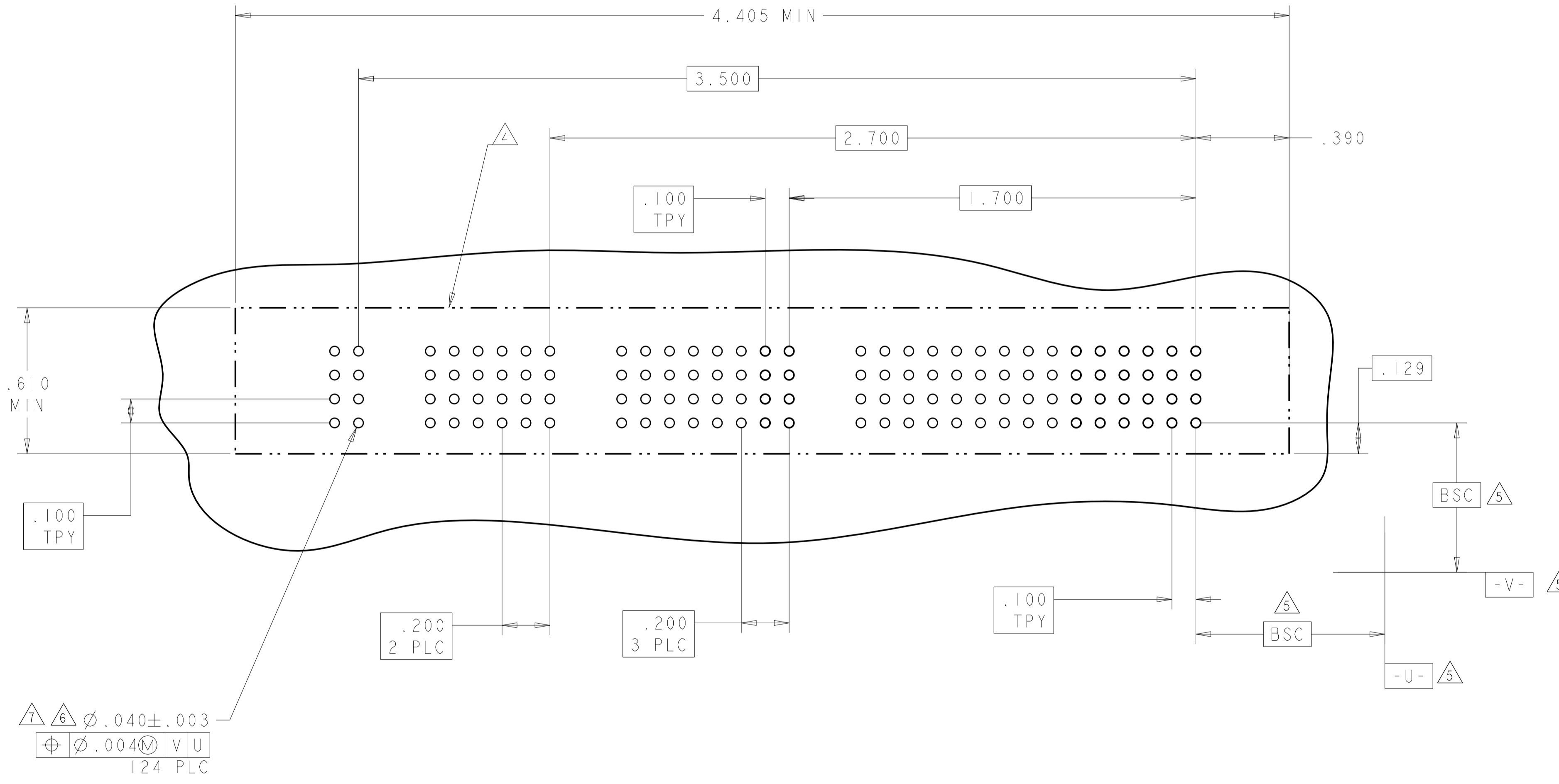
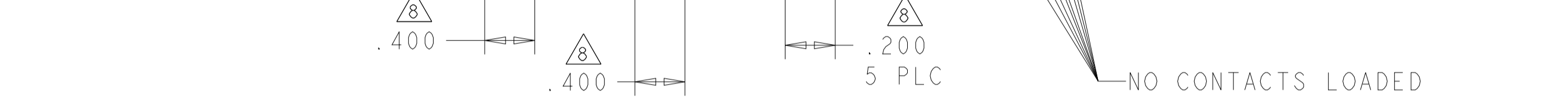

THIS DRAWING IS A CONTROLLED DOCUMENT.		OWN: R. GRZYBOWSKI 02MAY05	TE Connectivity
DIMENSIONS: INCHES		CHK: M. PERCHERKE 02MAY05	
TOLERANCES UNLESS OTHERWISE SPECIFIED:		APVD: M. PERCHERKE 02MAY05	NAME: VERTICAL RECEPTACLE WITH GUIDES MULTI-BEAM XL
0 PLC ±.01 1 PLC ±.01 2 PLC ±.01 3 PLC ±.005 4 PLC ±.0020 ANGLES ±.020		PRODUCT SPEC: 108-1973	SIZE: A100779
MATERIAL: -		APPLICATION SPEC: 114-13038	CAGE CODE: 6450541
FINISH: -		WEIGHT: -	RESTRICTED TO: -
CUSTOMER DRAWING		SCALE: 4:1	SHEET 8 OF 12 REV: E4

LOC		DIST		REVISONS			
GP	00	P	LTN	DESCRIPTION	DATE	DMN	APVD
-	-	-	-	SEE SHEET 1	-	-	-

PART NUMBER	ROWS	POWER				SIGNAL	
		P4	P3	P2	P1	2	1
2-6450541-2	D	GS	GS	GS	GS	AP	AP
	C					AP	AP
	B					AP	AP
	A					AP	AP

8S + 4P

PART NUMBER	ROWS	SIGNAL							
		8	7	6	5	4	3	2	1
2-6450541-4	D	AP	AP	AP	AP	AP	AP	AP	AP
	C	AP	AP	AP	AP	AP	AP	AP	AP
	B	AP	AP	AP	AP	AP	AP	AP	AP
	A	AP	AP	AP	AP	AP	AP	AP	AP

32S

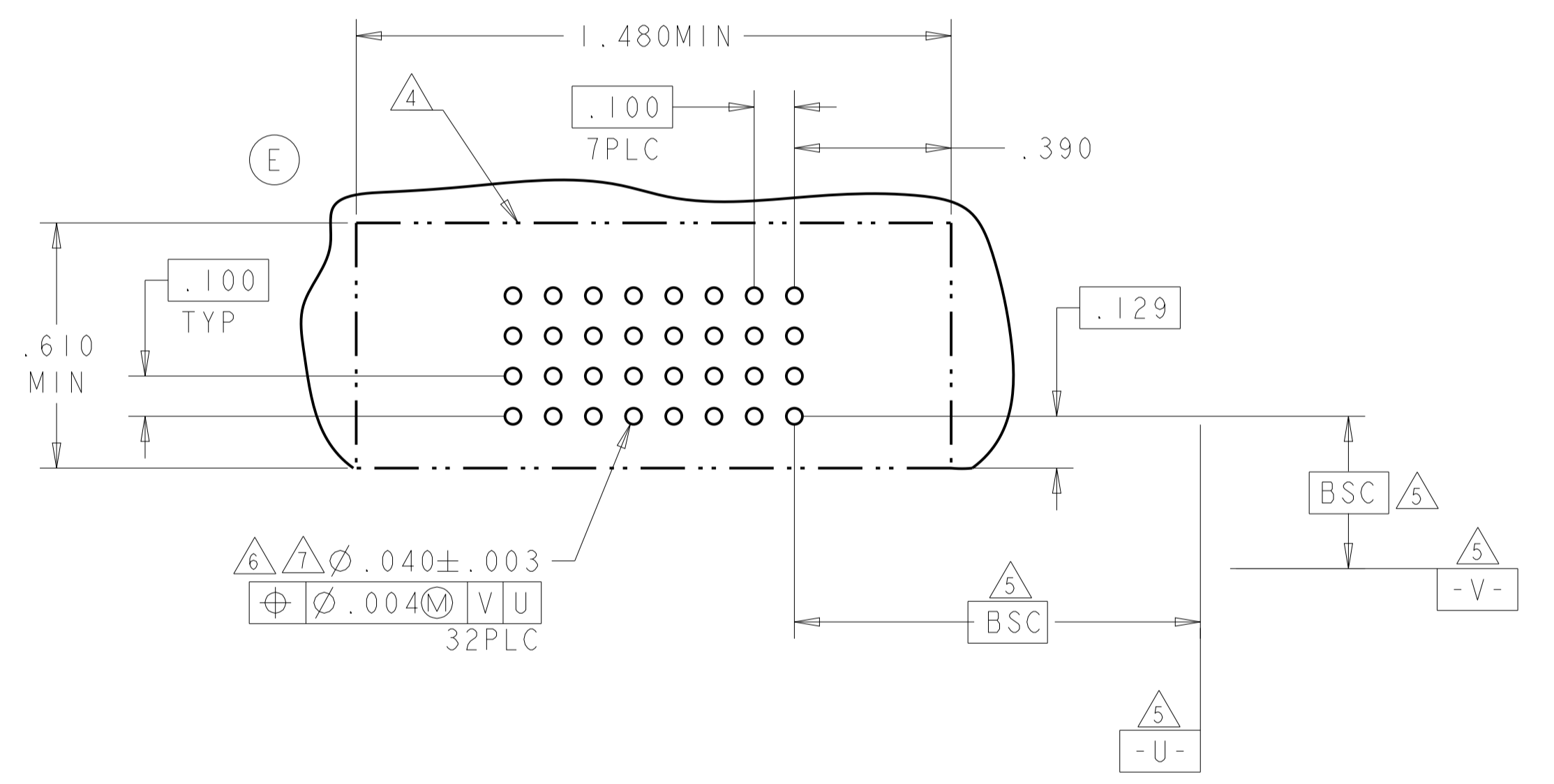
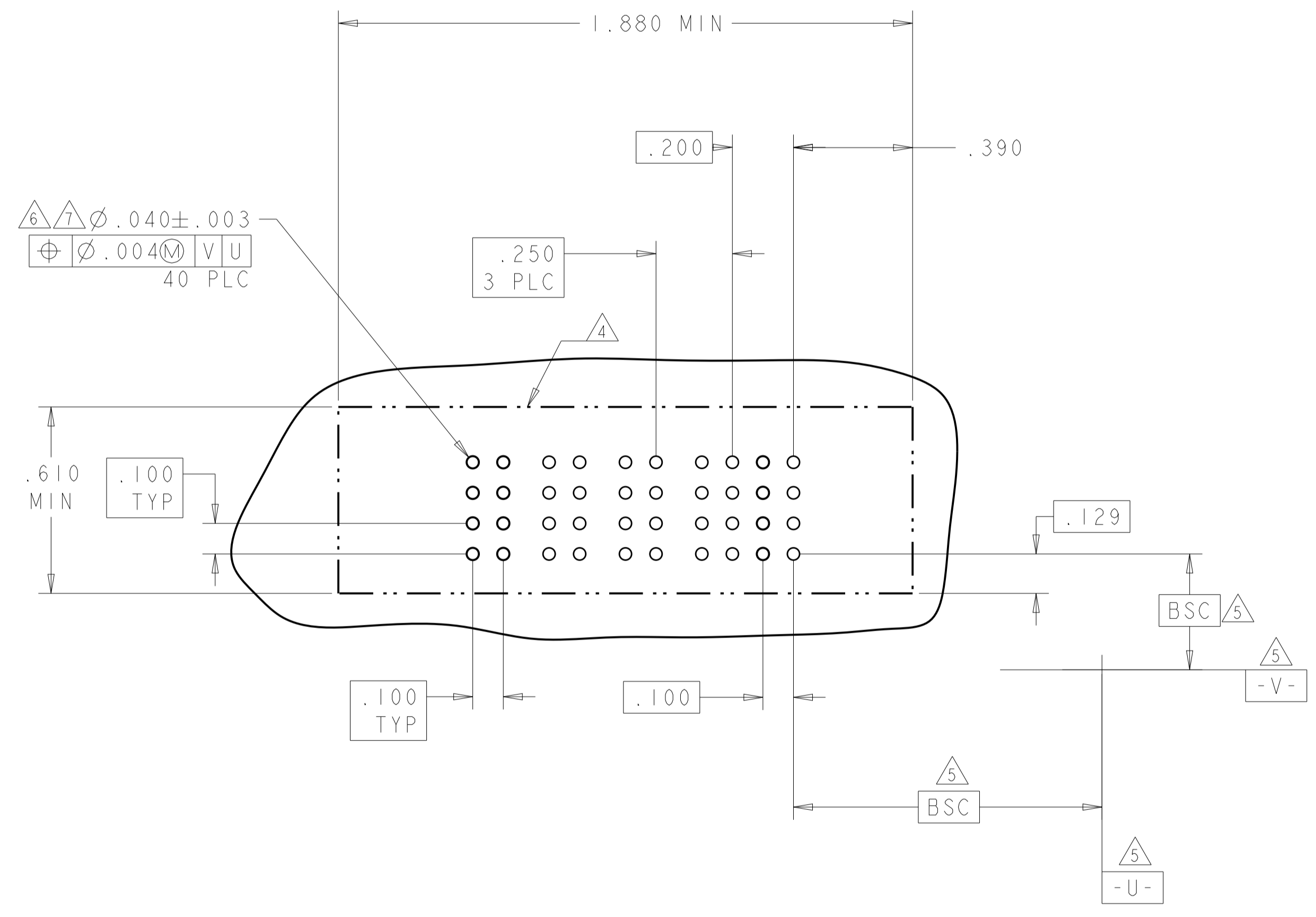

THIS DRAWING IS A CONTROLLED DOCUMENT.

DIMENSIONS: INCHES	TOLERANCES UNLESS OTHERWISE SPECIFIED: 0 PLC ±. 1 PLC ±.01 2 PLC ±.01 3 PLC ±.005 4 PLC ±.002 ANGLES ±.7°	OWN: B. GRZYBOWSKI 02MAY05 CHK: M. PERCHERKE 02MAY05 APVD: M. PERCHERKE 02MAY05	NAME: VERTICAL RECEPTACLE WITH GUIDES MULTI-BEAM XL
MATERIAL: -	FINISH: -	PRODUCT SPEC: 108-1973 APPLICATION SPEC: 114-13038 WEIGHT: -	SIZE: A1 CAGE CODE: 6450541 DRAWING NO: 100779
CUSTOMER DRAWING		SCALE: 4:1	SHEET 10 OF 12 REV: E4

4805 (3/11)

Компания «Life Electronics» занимается поставками электронных компонентов импортного и отечественного производства от производителей и со складов крупных дистрибьюторов Европы, Америки и Азии.

С конца 2013 года компания активно расширяет линейку поставок компонентов по направлению коаксиальный кабель, кварцевые генераторы и конденсаторы (керамические, пленочные, электролитические), за счёт заключения дистрибьюторских договоров

Мы предлагаем:

- Конкурентоспособные цены и скидки постоянным клиентам.
- Специальные условия для постоянных клиентов.
- Подбор аналогов.
- Поставку компонентов в любых объемах, удовлетворяющих вашим потребностям.
- Приемлемые сроки поставки, возможна ускоренная поставка.
- Доставку товара в любую точку России и стран СНГ.
- Комплексную поставку.
- Работу по проектам и поставку образцов.
- Формирование склада под заказчика.
- Сертификаты соответствия на поставляемую продукцию (по желанию клиента).
- Тестирование поставляемой продукции.
- Поставку компонентов, требующих военную и космическую приемку.
- Входной контроль качества.
- Наличие сертификата ISO.

В составе нашей компании организован Конструкторский отдел, призванный помогать разработчикам, и инженерам.

Конструкторский отдел помогает осуществить:

- Регистрацию проекта у производителя компонентов.
- Техническую поддержку проекта.
- Защиту от снятия компонента с производства.
- Оценку стоимости проекта по компонентам.
- Изготовление тестовой платы монтаж и пусконаладочные работы.



Тел: +7 (812) 336 43 04 (многоканальный)
Email: org@lifeelectronics.ru