

## Features

- Attenuation: 0.5 dB Steps to 31.5 dB
- Low DC Power Consumption
- Small Footprint, JEDEC Package
- Integral TTL Driver
- 50 ohm Impedance
- Test Boards are Available
- Tape and Reel Packaging Available
- Lead-Free CSP-1 Package
- 100% Matte Tin Plating over Copper
- Halogen-Free “Green” Mold Compound
- 260°C Reflow Compatible
- RoHS\* Compliant Version of AT90-0107

## Description

M/A-COM's MAATCC0009 is a GaAs FET 6-bit digital attenuator with integral TTL driver. Step size is 0.5 dB providing a 31.5 dB total attenuation range. This device is in an PQFN plastic surface mount package. The MAATCC0009 is ideally suited for use where accuracy, fast speed, very low power consumption and low costs are required.

## Ordering Information

Part Number	Package
MAATCC0009	Bulk Packaging
MAATCC0009TR	1000 piece reel
MAATCC0009-TB	Sample Test Board

Note: Reference Application Note M513 for reel size information.

\* Restrictions on Hazardous Substances, European Union Directive 2002/95/EC.

## Schematic with Off-Chip Components

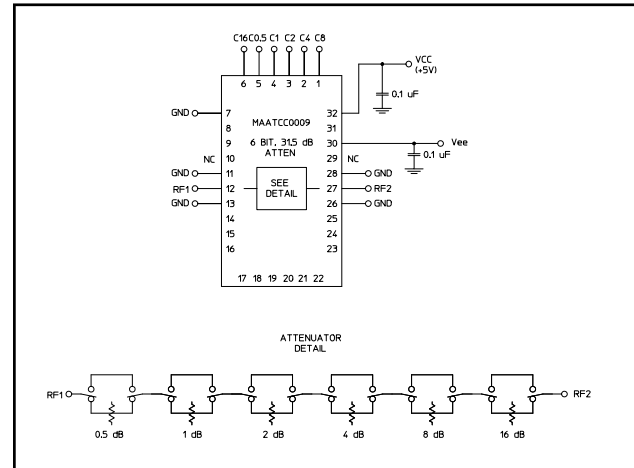

## Pin Configuration<sup>2</sup>

Pin No.	Function	Pin No.	Function
1	C8	17	NC
2	C4	18	NC
3	C2	19	NC
4	C1	20	NC
5	C0.5	21	NC
6	C16	22	NC
7	GND	23	NC
8	NC	24	NC
9	NC	25	NC
10	NC <sup>1</sup>	26	GND
11	GND	27	RF2
12	RF1	28	GND
13	GND	29	NC <sup>1</sup>
14	NC	30	-Vee
15	NC	31	NC
16	NC	32	+Vcc

1. Pins 10 & 29 must be isolated
2. The exposed pad centered on the package bottom must be connected to RF and DC ground. (For PQFN Packages)

• North America Tel: 800.366.2266 • Europe Tel: +353.21.244.6400  
 • India Tel: +91.80.4155721 • China Tel: +86.21.2407.1588  
 Visit [www.macomtech.com](http://www.macomtech.com) for additional data sheets and product information.

M/A-COM Technology Solutions Inc. and its affiliates reserve the right to make changes to the product(s) or information contained herein without notice.

**Electrical Specifications:  $T_A = +25^\circ\text{C}$ ,  $V_{ee} = -5\text{ V} \pm 0.25\text{ V}$ ,  $V_{cc} = +5\text{ V} \pm 0.25\text{ V}$**

Parameter	Test Conditions	Frequency	Units	Min	Typ	Max
Insertion Loss	—	DC - 4.0 GHz	dB	—	4.5	5.1
Attenuation Accuracy	Individual Bits 0.5-1-2-4-8-16 dB Any Combination of Bits 1 to 31.5 dB	DC - 4.0 GHz DC - 4.0 GHz	dB dB	— —	— —	$\pm(.3 + 7\%$ of atten setting) $\pm(.5 + 8\%$ of atten setting)
VSWR	Full Range	DC - 4.0 GHz	Ratio	—	2.0:1	2.2:1
Switching Speed	50% Cntl to 90%/10% RF 10% to 90% or 90% to 10%	— —	ns ns	— —	75 20	— —
1 dB Compression	— —	50 MHz 0.5 - 4.0 GHz	dBm dBm	— —	+21 +24	— —
Input $IP_3$	Two-tone inputs up to +5 dBm	50 MHz 0.5-4.0 GHz	dBm dBm	— —	+35 +48	— —
$V_{IL}$ $V_{IH}$	LOW-level input voltage HIGH-level input voltage	— —	V V	0.0 2.0	— —	0.8 5.0
$I_{in}$ (Input Leakage Current)	$V_{in} = V_{CC}$ or GND	—	$\mu\text{A}$	-1.0	—	1.0
$I_{cc}$ (Quiescent Supply Current)	$V_{cntrl} = V_{CC}$ or GND	—	$\mu\text{A}$	—	250	400
$\Delta I_{cc}$ (Additional Supply Current Per TTL Input Pin)	$V_{CC} = \text{Max}$ , $V_{cntrl} = V_{CC} - 2.1\text{ V}$	—	mA	—	—	1.0
$I_{EE}$	$V_{EE}$ min to max, $V_{in} = V_{IL}$ or $V_{IH}$	—	mA	-1.0	-0.2	—
Thermal Resistance $\theta_{jc}$	—	—	$^\circ\text{C/W}$	—	15	—

### Absolute Maximum Ratings <sup>3,4</sup>

Parameter	Absolute Maximum
Max. Input Power 0.05 GHz 0.5 - 4.0 GHz	+27 dBm +34 dBm
$V_{CC}$	$-0.5\text{ V} \leq V_{CC} \leq +7.0\text{ V}$
$V_{EE}$	$-8.5\text{ V} \leq V_{EE} \leq +0.5\text{ V}$
$V_{CC} - V_{EE}$	$-0.5\text{ V} \leq V_{CC} - V_{EE} \leq 14.5\text{ V}$
$V_{in}^5$	$-0.5\text{ V} \leq V_{in} \leq V_{CC} + 0.5\text{ V}$
Operating Temperature	$-40^\circ\text{C}$ to $+85^\circ\text{C}$
Storage Temperature	$-65^\circ\text{C}$ to $+125^\circ\text{C}$

- Exceeding any one or combination of these limits may cause permanent damage to this device.
- M/A-COM does not recommend sustained operation near these survivability limits.
- Standard CMOS TTL interface, latch-up will occur if logic signal is applied prior to power supply.

### Recommended PCB Configuration<sup>6</sup>

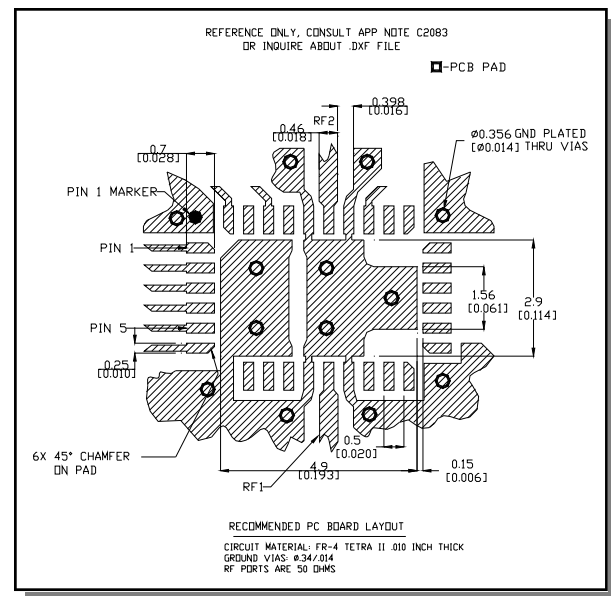

6. Application Note S2083 is available on line at [www.macom.com](http://www.macom.com)

## Handling Procedures

Please observe the following precautions to avoid damage:

### Static Sensitivity

Gallium Arsenide Integrated Circuits are sensitive to electrostatic discharge (ESD) and can be damaged by static electricity. Proper ESD control techniques should be used when handling these devices.

### Moisture Sensitivity

The MSL rating for this part is defined as Level 2 per IPC/JEDEC J-STD-020. Parts shall be stored and/or baked as required for MSL Level 2 parts.

## Truth Table (Digital Attenuator)

C16	C8	C4	C2	C1	C0.5	Attenuation
0	0	0	0	0	0	Loss, Reference
0	0	0	0	0	1	0.5 dB
0	0	0	0	1	0	1.0 dB
0	0	0	1	0	0	2.0 dB
0	0	1	0	0	0	4.0 dB
0	1	0	0	0	0	8.0 dB
1	0	0	0	0	0	16.0 dB
1	1	1	1	1	1	31.5 dB

0 = TTL Low; 1 = TTL High

## Typical Performance Curves

### Insertion Loss

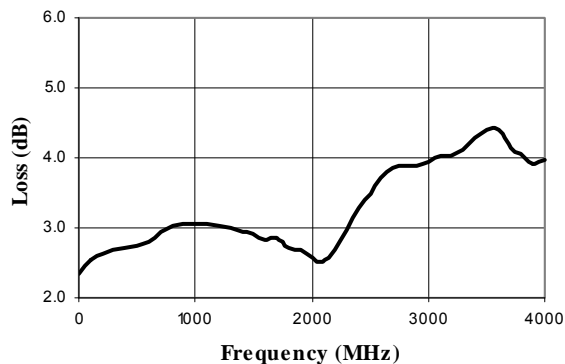

### VSWR @ Insertion Loss

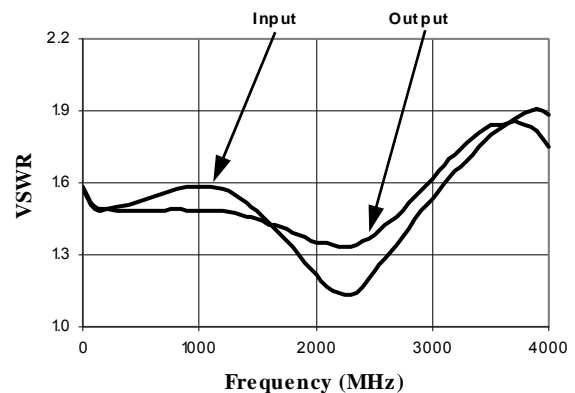

### Attenuation Error, 0.5 dB Bit

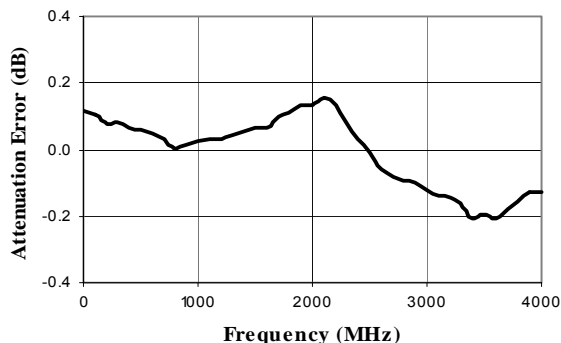

### Attenuation Error, 1 dB Bit

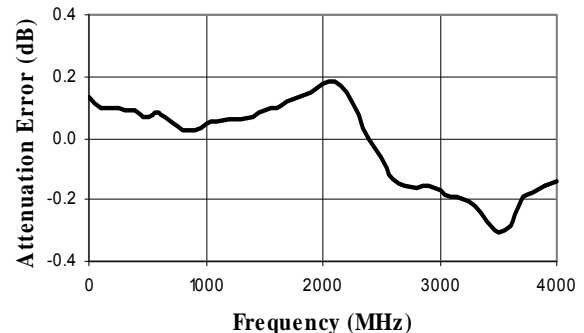

## Typical Performance Curves

Attenuation Error, 2 dB Bit

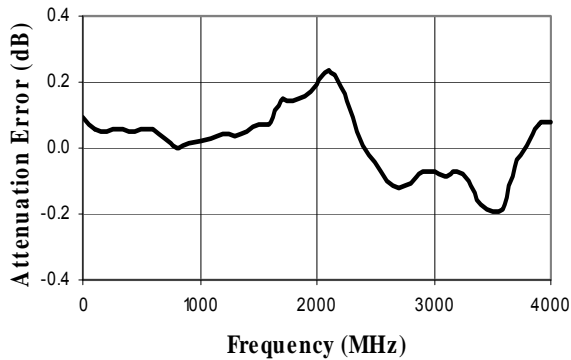

Attenuation Error, 4 dB Bit

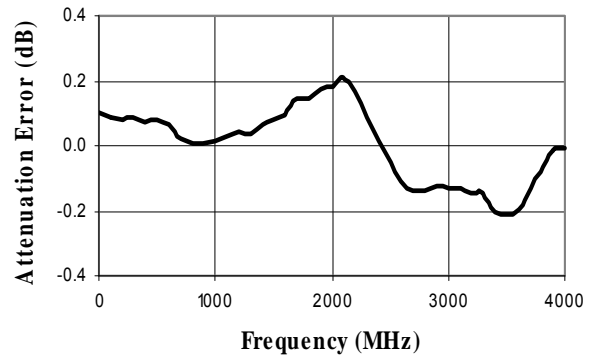

Attenuation Error, 8 dB Bit

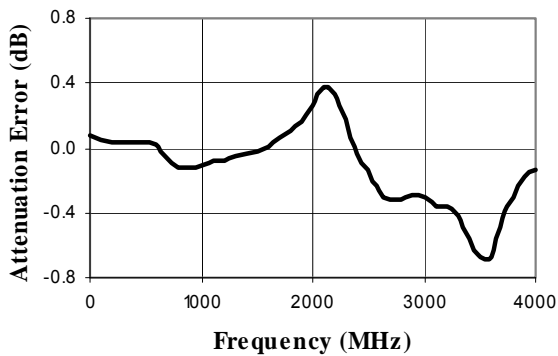

Attenuation Error, 16 dB Bit

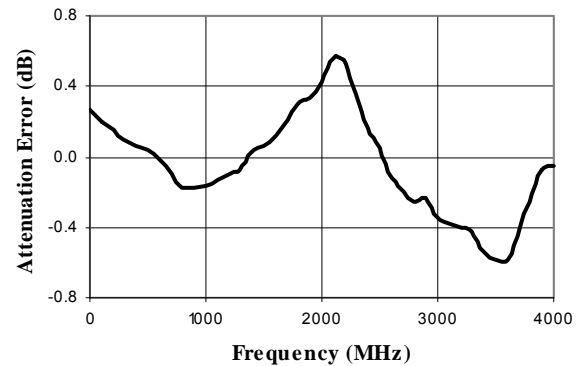

Attenuation Error, Max. Attenuation

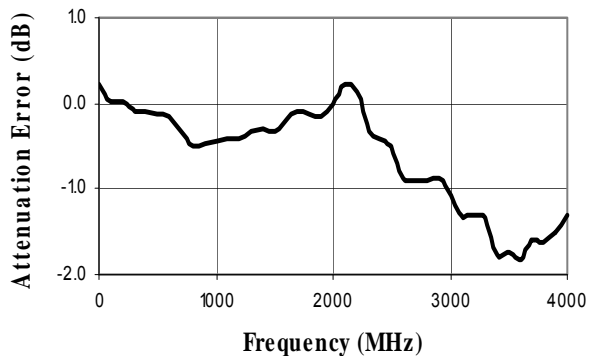

VSWR, 0.5 dB Bit

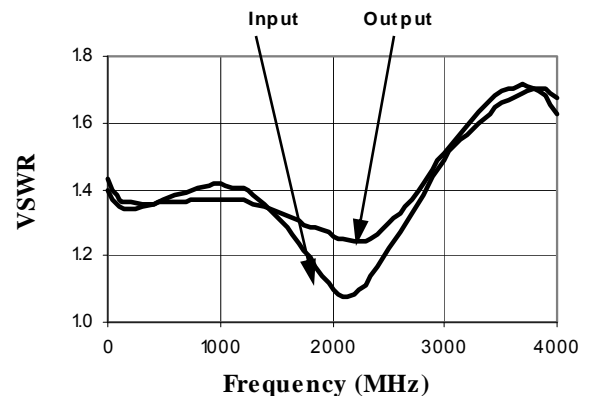

## Typical Performance Curves

**VSWR, 1 dB Bit**

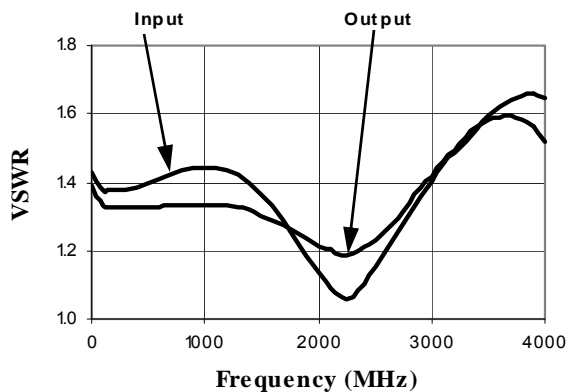

**VSWR, 2 dB Bit**

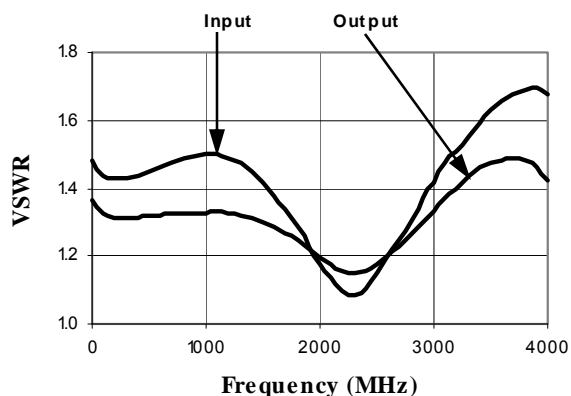

**VSWR, 4 dB Bit**

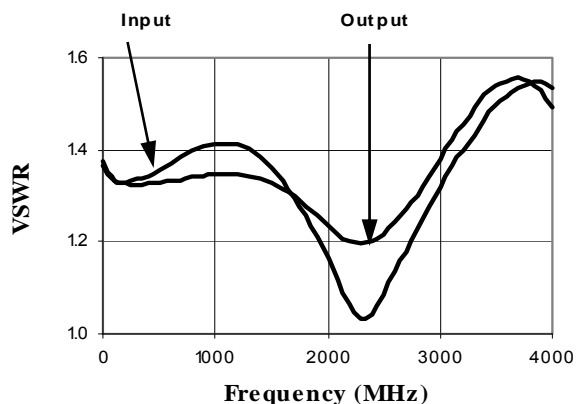

**VSWR, 8 dB Bit**

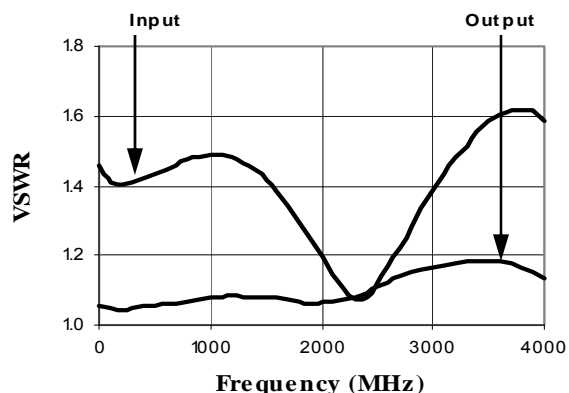

**VSWR, 16 dB Bit**

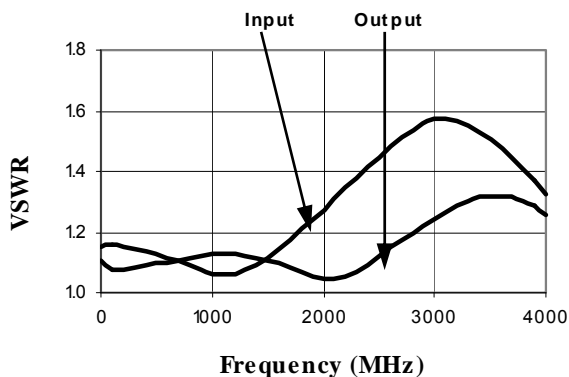

**VSWR, Max. Attenuation**

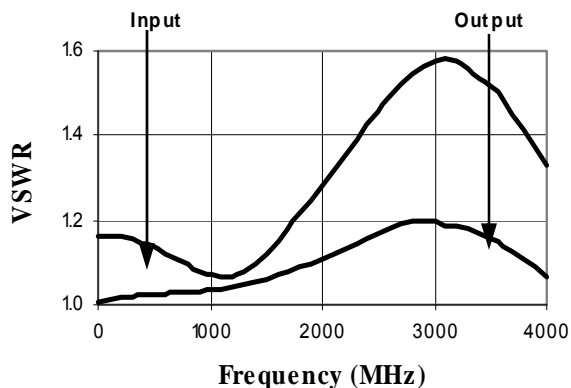

## Typical Performance Curves

**Typical Attenuation Deviation vs. Temperature for 0.5 dB Bit**

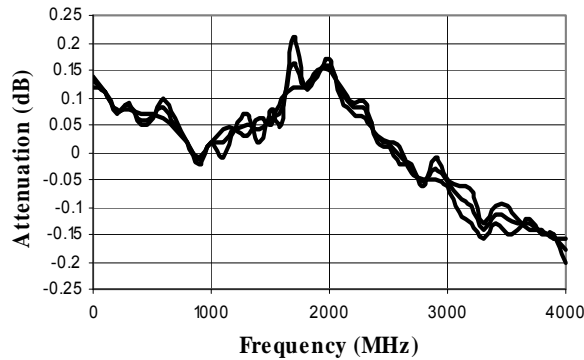

**Typical Attenuation Deviation vs. Temperature for 1 dB Bit**

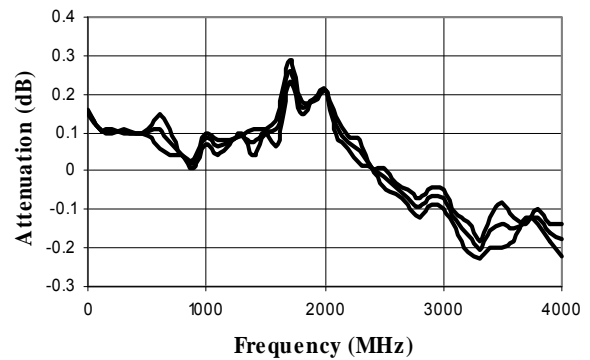

**Typical Attenuation Deviation vs. Temperature for 2 dB Bit**

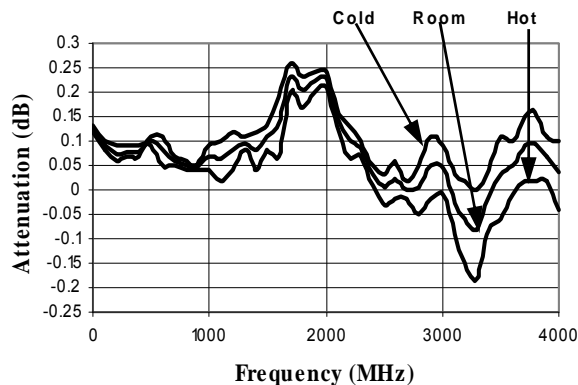

**Typical Attenuation Deviation vs. Temperature for 4 dB Bit**

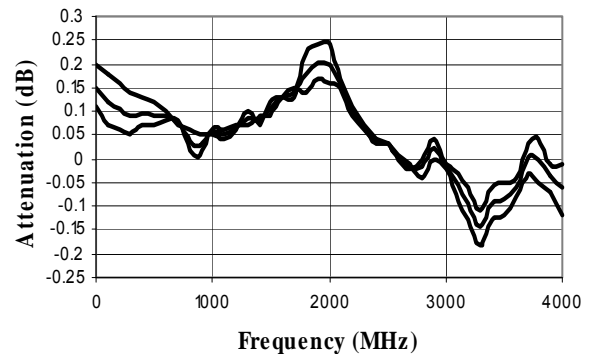

**Typical Attenuation Deviation vs. Temperature for 8 dB Bit**

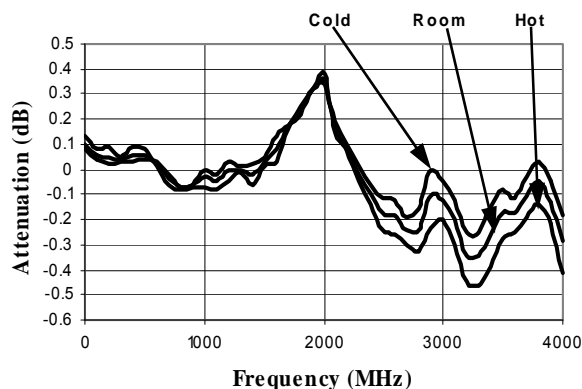

**Typical Attenuation Deviation vs. Temperature for 16 dB Bit**

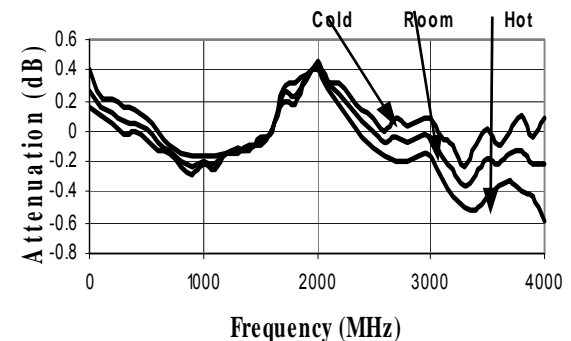

## Typical Performance Curves

**Typical Attenuation Deviation vs. Temperature at Maximum Atten.**

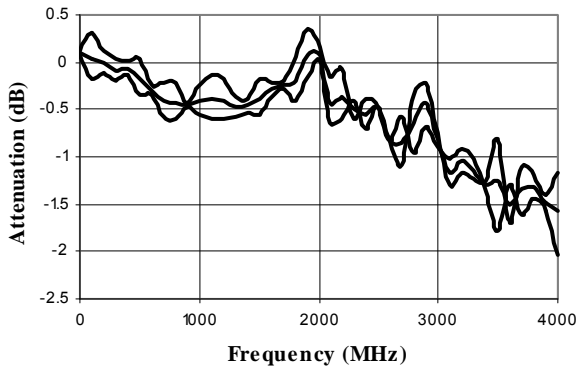

**Insertion Loss vs. Temperature**

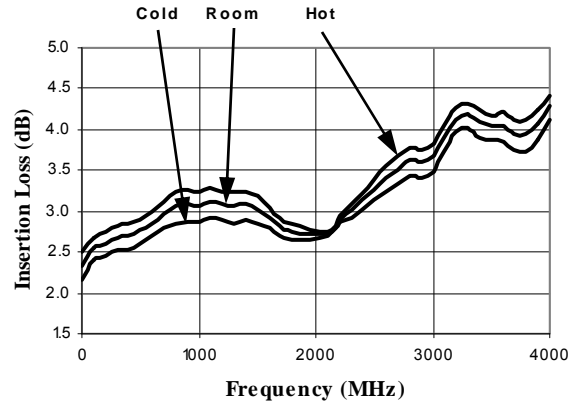

## CSP-1, Lead-Free 4 x 6 mm, 32-lead PQFN†

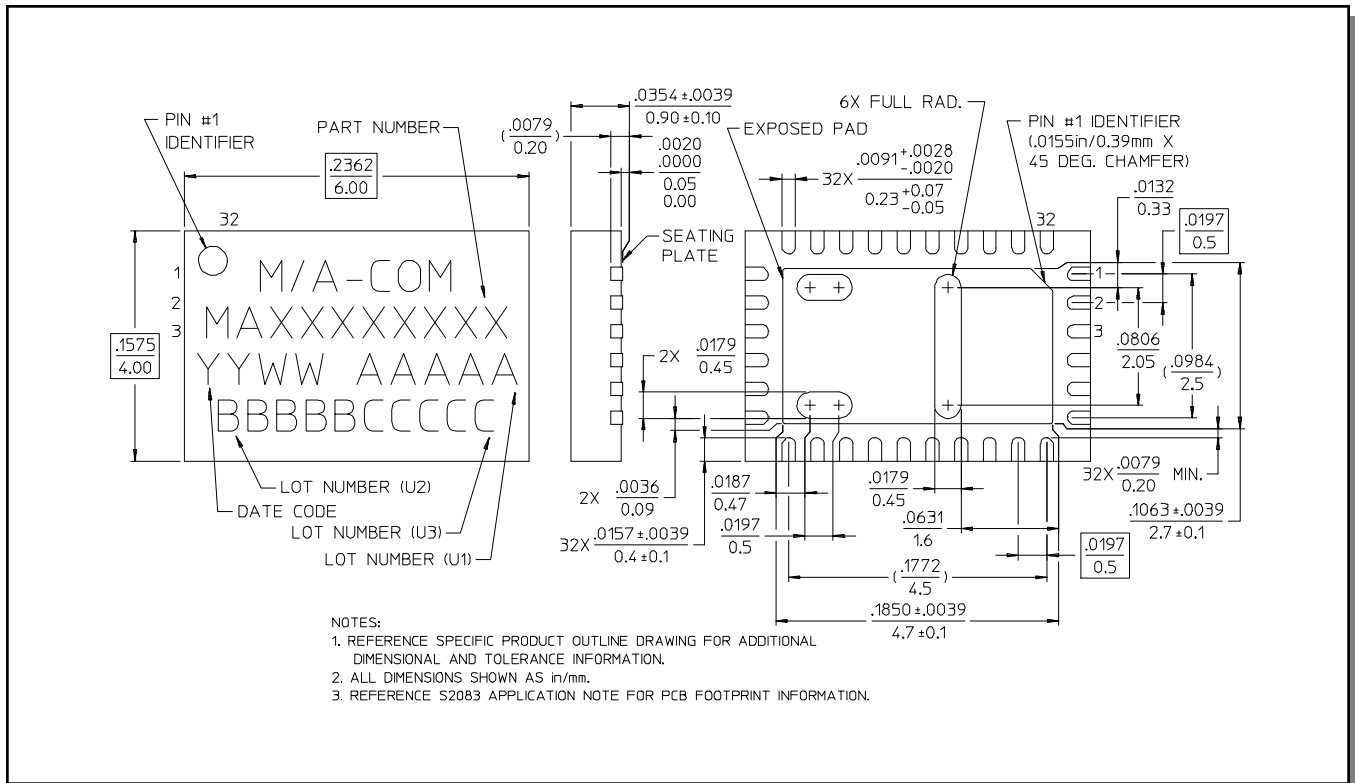

† Reference Application Note M538 for lead-free solder reflow recommendations.



Компания «Life Electronics» занимается поставками электронных компонентов импортного и отечественного производства от производителей и со складов крупных дистрибьюторов Европы, Америки и Азии.

С конца 2013 года компания активно расширяет линейку поставок компонентов по направлению коаксиальный кабель, кварцевые генераторы и конденсаторы (керамические, пленочные, электролитические), за счёт заключения дистрибьюторских договоров

Мы предлагаем:

- Конкуренспособные цены и скидки постоянным клиентам.
- Специальные условия для постоянных клиентов.
- Подбор аналогов.
- Поставку компонентов в любых объемах, удовлетворяющих вашим потребностям.
- Приемлемые сроки поставки, возможна ускоренная поставка.
- Доставку товара в любую точку России и стран СНГ.
- Комплексную поставку.
- Работу по проектам и поставку образцов.
- Формирование склада под заказчика.
- Сертификаты соответствия на поставляемую продукцию (по желанию клиента).
- Тестирование поставляемой продукции.
- Поставку компонентов, требующих военную и космическую приемку.
- Входной контроль качества.
- Наличие сертификата ISO.

В составе нашей компании организован Конструкторский отдел, призванный помогать разработчикам, и инженерам.

Конструкторский отдел помогает осуществить:

- Регистрацию проекта у производителя компонентов.
- Техническую поддержку проекта.
- Защиту от снятия компонента с производства.
- Оценку стоимости проекта по компонентам.
- Изготовление тестовой платы монтаж и пусконаладочные работы.



Тел: +7 (812) 336 43 04 (многоканальный)

Email: [org@lifeelectronics.ru](mailto:org@lifeelectronics.ru)