







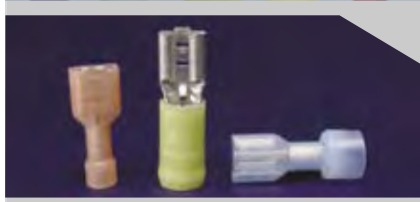

molex[®]
one company > a world of innovation

Solderless Terminals, Terminal Blocks and Connectors

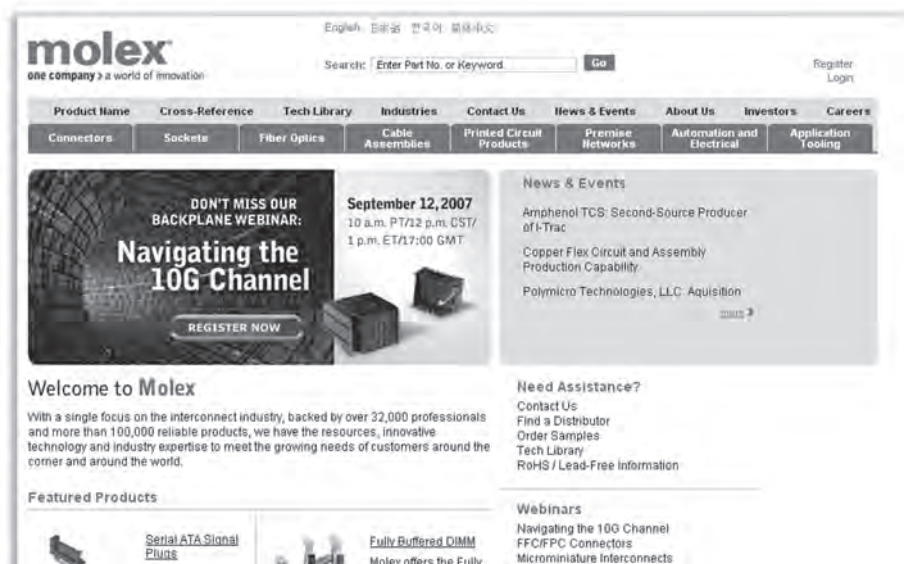

Table of Contents

Section	Title
 A collection of various solderless terminals, including ring terminals and spade terminals, in different colors and sizes, attached to wires.	A Solderless Terminals
 A variety of electrical splices, including heat-shrinkable sleeves and crimp-on splices, in different colors and sizes.	B Splices
 A collection of quick disconnects, including various types of crimp-on and push-on connectors, in different colors and sizes.	C Quick Disconnects
 A variety of wire management components, including wire ties, wire looms, and wire caps, in different colors and sizes.	D Wire Management
 A collection of terminal blocks, including various types of screw-terminal and crimp-terminal blocks, in different colors and sizes.	E Terminal Blocks
 A variety of industrial I/O connectors, including D-sub connectors, circular connectors, and fiber optic connectors, in different colors and sizes.	F Industrial I/O
 A collection of MX150L™ connectors, including various types of crimp-on and push-on connectors, in different colors and sizes.	G MX150L™
 A variety of power connectors, including various types of crimp-on and push-on connectors, in different colors and sizes.	H Power Connectors
 A photograph of a Molex building, showing the company name on the facade.	I Contact Information

Go to **molex.com** for more up-to-date, in-depth information.

Molex.com helps you get more done in less time. The site offers consistent navigation and robust search capabilities that allow you to search by application profile, keyword, feature and part number. The site includes all of the products and information found in this product catalog plus expanded content such as new products, 3D solid models, 2D drawings, product specifications, test results and sample request forms. You can even set up your own personalized molex.com simply by registering.



How do you want to search?

By Product Feature

Searching by multiple product features such as pitch, PCB thickness, wire size and current saves time by focusing only on the connectors that have the features you need.

In Your Language

Search product information in the language of your choice. Molex.com offers search capabilities in Japanese and Korean.

By Product Type

Find a connector by drilling through stages of the product hierarchy. Information becomes more specific with each level you advance to. At any time, you may access a "feature search" which gives you the ability to search across the product hierarchy that you are currently in.

By Product Name

This keyword search allows you to link to the commercially used name of a connector family or category, such as Mini-Fit® or IEEE 1394.

By Part Number

Enter an entire or partial Molex part number to get the search results. Or search by competitor part number to find the Molex equivalent.

By Industry

You can search by industry such as networking, portables or industrial. For a more detailed search once you select the application profile — notebooks, for example, you can select a specific product category such as "memory" or "microprocessors."

Why should you register?

By taking advantage of the optional registration, you will be able to get more — and more immediate — information on key applications in your market. Registering allows you to sign up for a monthly e-mail and be among the first to hear about new products. Finally, you can set site-specific bookmarks and self-populate your response screens, making it easier to order samples on-line. Simply find your solution on-line or in this catalog and then order samples on molex.com.

▶ Tooling How to Find Tooling on www.molex.com

Step 1: Go to www.molex.com

Step 2: Enter Connector Part Number Into Search

Enter Part Number Here

Hit the "GO" Button



Step 3: Review Product Page for Tooling Links on Right

Review tooling link(s) and double click black link

Step 4: Review Tooling Page Application Tooling Specification

Application Tooling Specification sheets have all tooling information: terminals used in tool, crimp height, pull force, perishable tool kits, repair kits, how to measure go/no-go, list of products processed, new product number, old product number, wire strip length, part list for tooling components, exploded view of installation and maintenance and warranty information

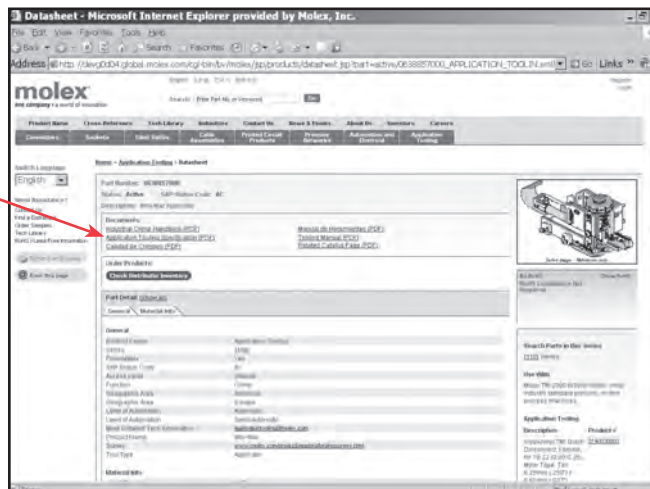
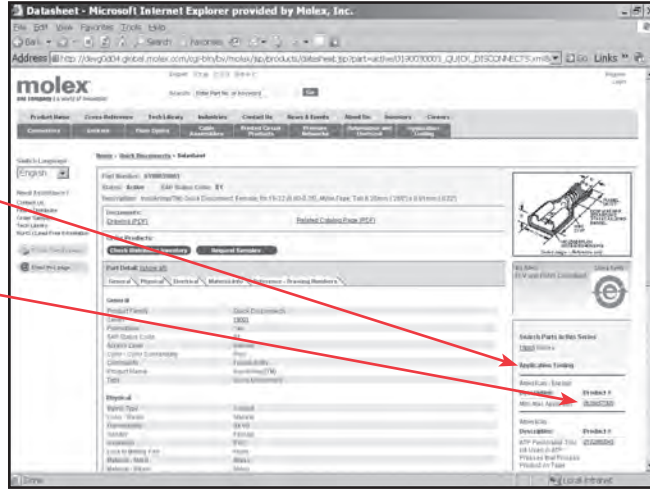

▶ Tooling How to Find Tooling on www.molex.com

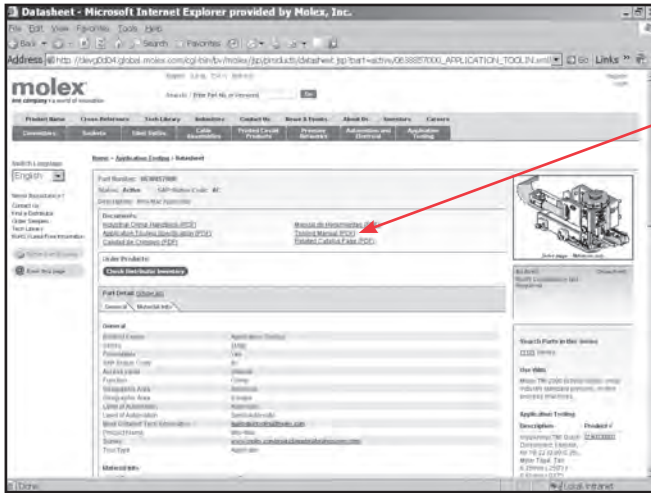

Step 4: Review Tooling Page Tooling Manual

The Tooling Manual has all of the basic information with regard to the tool. Not all tools have a manual

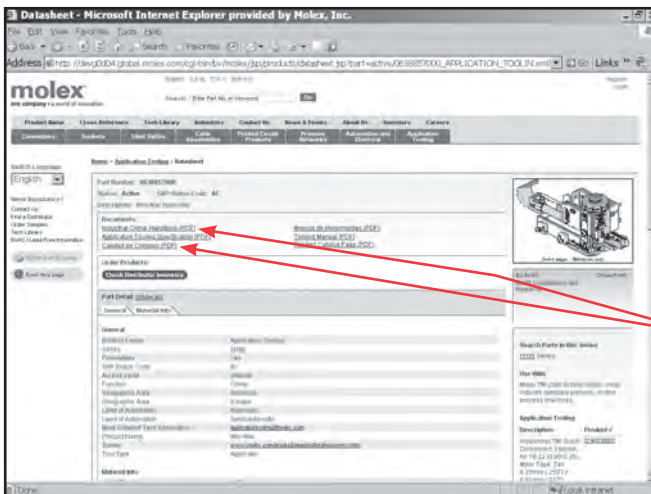

Step 5: Review Tooling Page Crimp Quality Handbook

The Crimp Quality Handbook has all of the basic information regarding a proper crimp. Open barrel (CPD) and closed barrel (TBO) have their own quality manuals linked on the web. There are English and Spanish versions of both manuals.

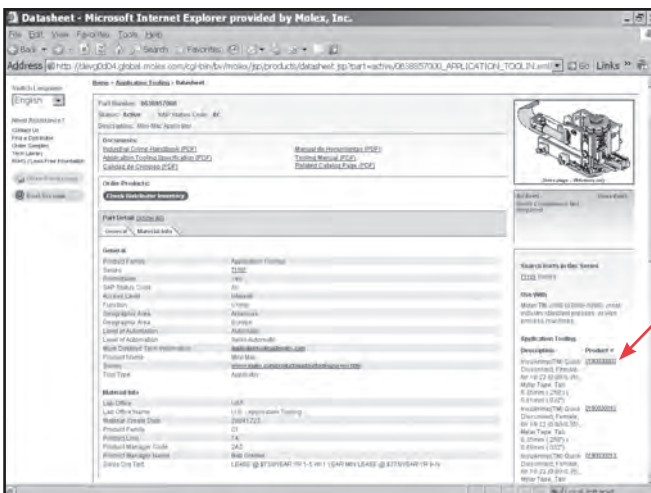

Other Information on Page

Tooling page will show all of the web-published terminals that the tool will run

► Tooling Introduction to Crimp Technology

Developed to replace the need to solder terminations, crimping technology provides a high quality connection between a terminal and a wire at a relatively low applied cost. The methods for applying crimp terminations depend on the application and volume, and range from hand-held devices to fully-automated systems. The application methods include a basic hand tool, a press and die set, a stripper crimper or a fully automatic wire processing system. But no matter what method is used, the setup of each tool is critical for achieving a quality crimp.



Website: Please visit the Molex website to view the most current Application Tooling information. The Molex website is continuously updated with the latest information. (www.molex.com)

TERMINOLOGY

Bellmouth (Flare)

The flare that is formed on the edge of the conductor crimp acts as a funnel for the wire strands. This funnel reduces the possibility that a sharp edge on the conductor crimp will cut or nick the wire strands. As a general guideline, the conductor bellmouth needs to be approximately 1 to 2x the thickness of the terminal material.*

Conductor Brush

The conductor brush is made up of the wire strands that extend past the conductor crimp on the contact side of the terminal. This helps ensure that mechanical compression occurs over the full length of the conductor crimp. The conductor brush should not extend into the contact area.

Conductor Crimp

This is for the metallurgical compression of a terminal around the wire's conductor. This connection creates a common electrical path with low resistance and high current carrying capabilities.

Conductor Crimp Height

The conductor crimp height is measured from the top surface of the formed crimp to the bottom most radial surface. Do not include the extrusion points in this measurement (See Figure 2). Measuring crimp height is a quick, non-destructive way to help ensure the correct metallurgical compression of a terminal around the wire's conductor and is an excellent attribute for process control. The crimp height specification is typically set as a balance between electrical and mechanical performance over the complete range of wire stranding and coatings, and terminal materials and platings. Although it is possible to optimize a crimp height to individual wire strandings and terminal platings, one crimp height specification is normally created.

Cut-off Tab Length

This is the material that protrudes outside the insulation crimp after the terminal is separated from the carrier strip. As a general rule, the cut-off tab is approximately 1.0 by 1.5x terminal material thickness.* A cut-off tab that is too long may expose a terminal outside the housing or it may fail electrical spacing requirements. In most situations, a tool is setup to provide a cut-off tab that is flush to one material thickness.

*Consult individual terminal specifications

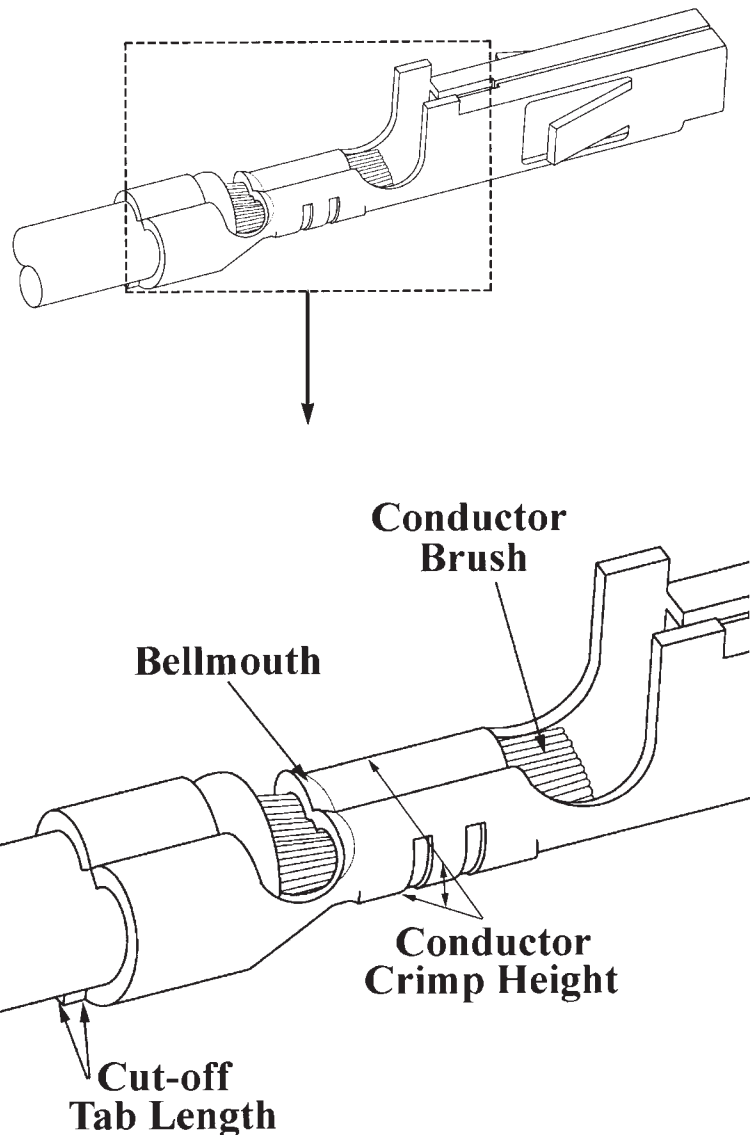

› Tooling Introduction to Crimp Technology

TERMINOLOGY (CONTINUED)

Extrusions (Flash)

These are the small flares that form on the bottom of the conductor crimp resulting from the clearance between the punch and anvil tooling. If the anvil is worn or the terminal is over-crimped, excessive extrusion results. An uneven extrusion may also result if the punch and anvil alignment is not correct, if the feed adjustment is off, or if there is insufficient/excessive terminal drag.

Insulation Crimp (Strain Relief)

This is the part of the terminal that provides both wire support for insertion into the housing and allows the terminal to withstand shock and vibration. The terminal needs to hold the wire as firmly as possible without cutting through to the conductor strands. The acceptability of an insulation crimp is subjective and depends on the application. A bend test is recommended to determine whether or not the strain relief is acceptable for each particular application.

Insulation Crimp Height

Molex does not specify insulation crimp heights because of the wide variety of insulation thickness, material, and hardness. Most terminals are designed to accommodate multiple wire ranges. Within the terminals range, an insulation diameter may not completely surround the wire or fully surround the diameter of the wire. This condition will still provide an acceptable insulation crimp for most applications.

- A large insulation should firmly grip at least 88% of the wire
- A smaller insulation should firmly grip at least 50% of the wire and firmly hold the top of the wire

To evaluate the insulation section cut the wire flush with the back of the terminal. Once the optimum setting for the application is determined it is important to document the insulation crimp height. Then, as part of the setup procedure the operator can check the crimp height.

Insulation Position

This is the location of the insulation in relation to the transition area between the conductor and insulation crimps. Equal amounts of the conductor strands and insulation need to be visible in the transition area. The insulation position ensures that the insulation is crimped along the full length of the insulation crimp, and that no insulation gets crimped under the conductor crimp. The insulation position is set by the wire stop and strip length for bench applications. For automatic wire processing applications the insulation position is set by the in/out press adjustment.

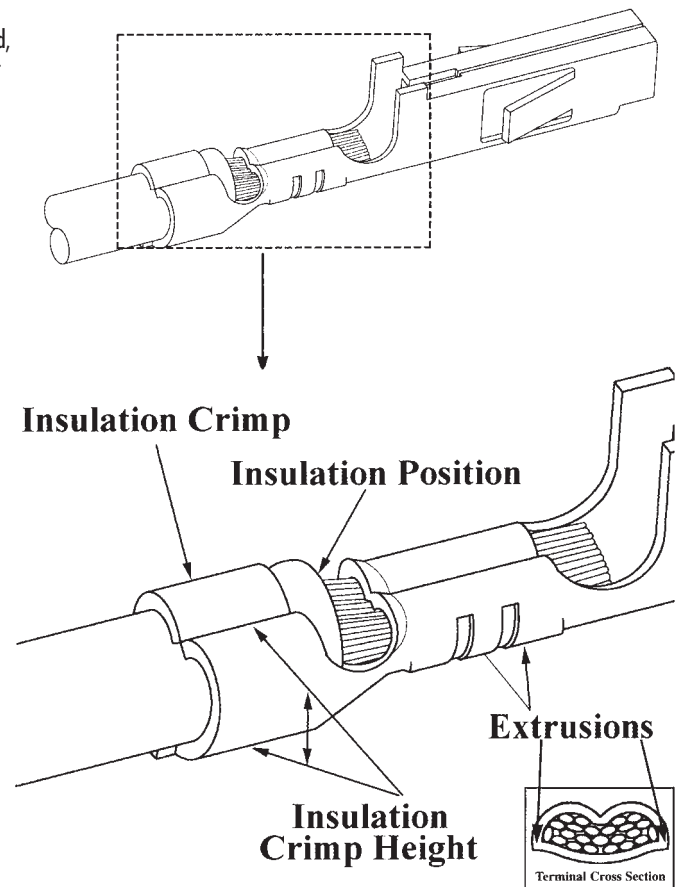

Strip Length

The strip length is determined by measuring the exposed conductor strands after the insulation is removed. The strip length determines the conductor brush length when the insulation position is centered.

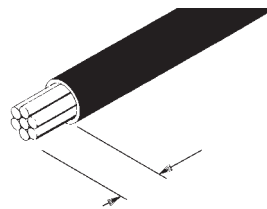

Process

The combination of people, equipment, tooling, materials, methods and procedures needed to produce a crimp termination. Process control is used to track attributes over time to aid in the detection of change to the process. Detecting a process change when it happens helps prevent many thousands of bad crimps.

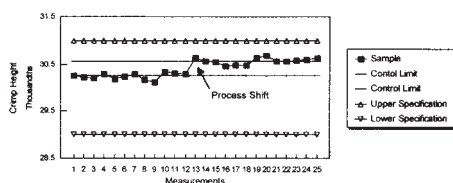

Pull Force Testing

Pull Force Testing is a quick, destructive way to evaluate the mechanical properties of a crimp termination. When making a crimp, enough pressure must be applied to breakdown the oxides that build up on the stripped conductor and the tin plating on the inside of the terminal grip. This is necessary to provide a good metal-to-metal contact. If this does not occur, resistance can increase. Over crimping a crimp termination will reduce the circular area of the conductor and increase resistance.

Pull Force Testing is also a good indicator of problems in the process. Cut or nicked strands in the stripping operation, lack of bellmouth or conductor brush, or incorrect crimp height or tooling will reduce pull force. Wire properties and stranding, and terminal design (material thickness and serration design), also can increase or decrease pull force levels.

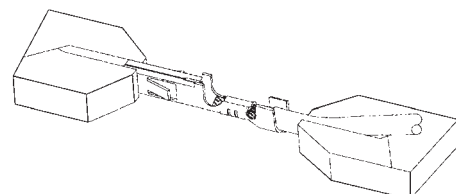

► Tooling Introduction to Crimp Technology

TERMINOLOGY (CONTINUED)

Shut Height

The distance, at bottom dead center on a press, from the tooling mounting base plate to the tooling connection point on the ram of the press.

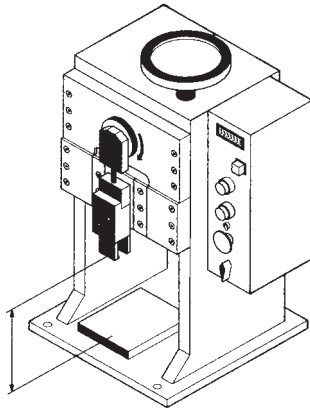

Terminal Position

The terminal position is set by the alignment of the terminal to the forming punch and anvils, and the carrier strip cut-off tooling. The tool set-up determines conductor bellmouth, cut-off tab length, and terminal extrusions.

*Consult individual terminal specifications

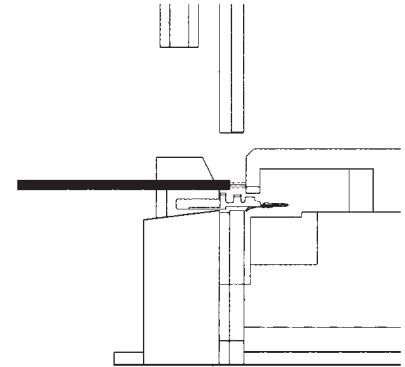

ASSOCIATED MATERIALS

Caliper

A gauge, consisting of two opposing blades, for measuring linear dimensional attributes.

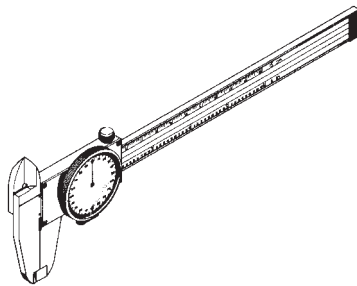

Ruler (Pocket Scale)

This is used to estimate the five piece measurement of bellmouth, cut-off tab, conductor brush, wire position, and strip length. The recommended maximum resolution is .5mm (.020 in).

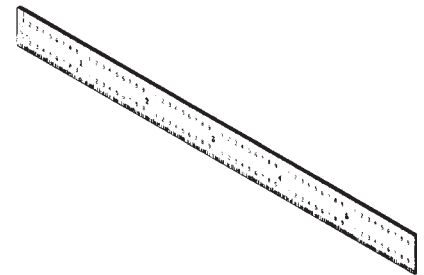

Eye Loop

A magnification tool, normally 10x power or greater, which is used to aid visual evaluation of a crimp termination.

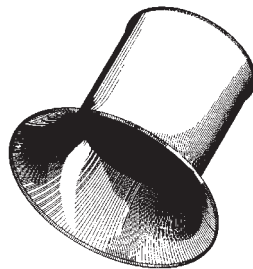

Pull Tester (Reference Figure 5)

A device used to determine the mechanical strength of a crimp termination. Most pull testing is done with a device that clamps the wire, pulls at a set speed, and measures force by means of a load cell. A pull tester also can be as simple as hanging fixed weights on the wire for a minimum of one minute.

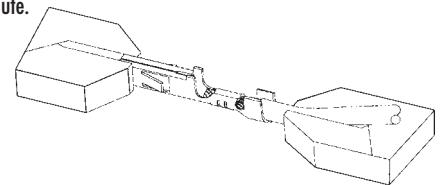

Crimp Micrometer

This is a micrometer specifically designed to measure crimp height. The measurement is taken in the center of the crimp so it is not influenced by the conductor bellmouth. It has a thin blade that supports the top of the crimp while a pointed section determines the bottom most radial surface.

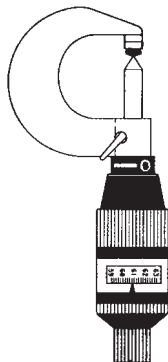

Toolmaker's Microscope

This is used for close visual evaluation and statistical measurement of bellmouth, cut-off tab, conductor brush, wire position, and strip length.

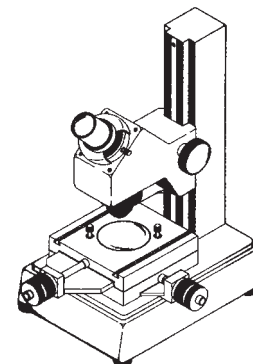

Glossary

A

Absorption: 1) The amount of moisture a substance will assimilate and retain. 2) The dissipation of energy by radiation passing through a medium.

Accelerated Aging: A test in which voltage, temperature and other parameters are increased above normal operating values to obtain observable deterioration in a relatively short period of time.

Accessories: Mechanical devices, such as cable clamps, added to connectors, and other such attachable hardware that makes up the total connector configuration.

Adapter: An intermediate device that attaches special accessories and provides for special mounting.

Admittance: The ease with which an alternating current flows in a circuit. The reciprocal of impedance.

Alloy: A combination of two or more elements of which at least one is a metal.

Ampere: A standard unit of current. Designated as the amount of current that occurs when one volt of emf is applied across one ohm of resistance. An ampere of current is produced by one coulomb of charge passing a point in one second.

Attenuation: Power or signal strength loss in an electrical system. Decrease in power expressed in decibels (dB).

B

Back Mounted: When a connector is mounted from the inside of a panel or box with its mounting flanges inside the equipment.

Bandwidth: The amount of data that can be sent through a network connection, measured in bits per second (bps).

Barrel: The back end portion of a terminal or contact that is crimped to the conductor or insulation or both.

Bellmouth: Flared or a tapered entrance to a connector crimp barrel permitting an essentially smooth stress transition zone between the highly compressed, crimped wire within the barrel and the wire (uncompressed, uncrimped) outside of the barrel, thus preventing micro-cracking of both the barrel and the wire.

Blind Mating: A term describing the mating of rack-and-panel connectors via guide or key pins that ensure correct alignment of the connector halves during mating.

Boot: 1) A form placed around wire termination of a multiple-contact connector to hold the liquid potting compound before it hardens. 2) A protective housing, usually made from a resilient material, that prevents moisture entry into a connector.

Braid: Woven bare metallic or tinned copper wire used as shielding for wires and cables and as ground wire for batteries or heavy industrial equipment. Also a woven fibrous protective outer covering over a conductor or cable.

Brazing: A group of welding processes in which the filler is a nonferrous metal or alloy with a melting point greater than 1000 degrees Fahrenheit, but lower than that of the metals or alloys to be joined. Brazing is sometimes referred to as hard soldering.

Bulkhead Connector: Type of connector designed for insertion into a panel cutout from the component side.

C

Cable: An assembly of one or more conductors or fiber optic strands within a protective sheath.

Cable Pierce: A termination technique in which a metal lance or tine in the terminal passes through the insulation and into the conductive strands.

Canadian Standards Association (CSA): A Canadian organization that sets certain standards for connector testing.

Capacitance: The ability of a dielectric material between conductors to store an electrical charge when a voltage difference exists between conductors.

Centerline Spacing: See Pitch.

Chamfer: Angle on the inside edge of the barrel entrance of a terminal or connector housing that permits easier insertion of the cable into the barrel or of a plug into a receptacle.

Circuit: A conductive channel through which electrical current flows (in a closed loop termed closed-circuit) or through which light energy flows.

Component Density: The quantity of components on a printed circuit board per unit area.

Compression Terminal: Terminal crimped by an externally applied force; the conductor is also crimped by such force inside the tube-like terminal body.

Conductivity: A material's ability to conduct electric current expressed in terms of the current per unit of applied voltage or 1/impedance.

Conductor: An uninsulated wire or combination of wires suitable for carrying electric current.

Connector: A coupling device that provides an electrical and mechanical connection or disconnection between two circuits.

Contact: The conducting part of a connector that acts with another such part to complete or break a circuit. Also known as terminals.

Contact Durability: Endurance measured by the number of insertion and withdrawal cycles that a connector withstands while remaining within its specified electrical and mechanical performance levels.

Contact Force: See Normal Force.

Contact Insertion Force: The amount of force required to insert a contact into the connector housing.

Contact Pressure: The force that mating surfaces exert against each other.

Contact Rating: The maximum and minimum voltage, current and power that a contact system is capable of carrying under certain specified conditions.

Contact Resistance: Maximum permitted electrical resistance of pin and socket contacts when assembled in a connector under typical service use.

Contact Retention: Defines the minimum axial load in either direction that a contact must withstand while remaining firmly seated in its normal position in the connector housing.

Continuity: A continuous path for the flow of current in an electrical circuit.

Coplanarity: 1) In general, the levelness of the terminals. 2) The maximum distance between the lowest and highest SMT solder tail when the connector rests on a perfectly flat surface.

Coupling Ring: A device used on cylindrical connectors to lock a plug and receptacle together. It may or may not make the connector easier to mate/unmate.

Crosstalk: A type of interference caused when the signal on one conductor interferes with the signal on an adjacent conductor.

Current: A movement of electrons, either positive or negative ions, or holes. The rate of transfer of electricity from one point to another. Current is usually measured in amperes.

Current Carrying Capacity: The maximum current an insulated conductor can safely carry without exceeding its insulation and jacket temperature limitations.

Current Rating: Maximum current that a device is designed to conduct for a specified time at a specified operating temperature.

D

Daisy Chain: Two or more connectors terminated on the same cable. Each connector shares the same electrical path but provides independent signal distribution.

Dielectric: Non-conducting barriers that protect individual conductors from accidental contact with other conductors (a "short circuit") and allow uninterrupted flow or current.

Dielectric Strength: The maximum voltage that a dielectric material can withstand, under specified conditions, without rupturing. It is usually expressed in volts/unit thickness.

Dielectric Withstanding Voltage: Maximum potential gradient that a dielectric material can withstand without failure.

Discontinuity: A broken connection, or the loss of a specific connection characteristic.

Discrete Wire: A single cable or wire. Contrast it to ribbon cable, which consists of multiple cables or wires.

Disengagement Force: See Withdrawal Force.

Dual Beam: A type of stamped-and-formed contact where the female contact holds the male contact between two beams.

Durability: See Contact Durability.

E

Electromagnetic: Pertaining to the combined electric and magnetic fields associated with movements of electrons through conductors.

Electromagnetic Interference (EMI): Electromagnetic waves that interrupt signals in electronic equipment.

Engagement and Separation Force: The amount of force needed to engage (mate) and/or separate (unmate) contact elements in mating connectors. Force levels vary with circuit size. Total connector engagement force is approximated by multiplying the number of circuits in the housing by the per circuit engagement (mating) force.

Epoxy: A family of thermosetting resins used in the packaging of semiconductor devices and fiber optics. Epoxies form a chemical bond to many metal and glass surfaces.

F

Feed Through: 1) A conductor that connects patterns on opposite sides of a printed circuit board. Also called interfacial connection. 2) A connector or terminal block, usually having double-ended terminals that permit simple distribution and bussing of electrical circuits. Also used to describe a bushing in a wall or bulkhead separating compartments at different pressure levels with terminations on both sides.

Ferrule: 1) A short tube used to make solderless connections to shielded or coaxial cable. Also molded into the plastic inserts of multiple contact connectors to provide strong, wear-resistant shoulders on which contact retaining springs can bear. 2) A mechanical fixture used to confine and align the stripped end of a fiber in a fiber optic connector.

First Mate/Last Break (FMLB): A connector design in which power contacts engage before signal contacts when two connector halves are mated. FMLB prevents damage to electrical circuitry in the system by having the ground pin mate first.

Flammability: The measure of the material's ability to support combustion.

Flange: A projection extending from or around the periphery of a connector and provided with holes to permit mounting the connector to a panel or to another mating connector half.

Flex Life: The ability of a conductor or cable to withstand repeated bending.

Frequency: The number of times a periodic action occurs in a unit of time. The number of cycles that an electric current completes in one second.

G

Gang Disconnect: A connector that permits the rapid and simultaneous connection and disconnection of two or more electrical circuits.

Gas Tightness: The characteristic of a contact which is impervious to ingress by corrosive gases.

Gauge: A term used to denote the physical size of a wire.

Gigabit Ethernet: A Local Area Network (LAN) protocol that supports data transfer rates of 1 Gb/s.

Grid: An orthogonal network of two sets of parallel, equidistant lines used for locating points on a printed board. Connections should be located on the cross-points of the grid lines.

Ground: A common or reference point in an electrical circuit that can be earth ground and/or a chassis. It is with respect to this common point that all voltages are measured.

H

Header: The male connector assembly of a two-piece post-and-box connector attached to a PCB. Headers are available in two styles: shrouded and unshrouded.

Hermaphroditic Connector: An interconnecting device in which both mating parts are identical at their mating surfaces. Also a connector housing that accepts both male and female terminals.

Hi Pot: A dielectric strength test that tests the insulation between two circuits.

Hot Pluggable: Adding electronic components to a system (plugging) or removing electronic components from a system (unplugging) while the system is powered up (hot). Also known as live insertion or live mating.

Hygroscopic: Capable of absorbing moisture from the air.

I

Impedance: The total opposition that a circuit offers to the flow of alternating current, or any other varying current, at a particular frequency.

Inductance: The property of a circuit or circuit element that opposes a change in current flow, causing current changes to lag behind voltage changes.

Infrared Reflow Solder: A soldering process in which heat from infrared radiation is used to melt solder paste between connector leads and PCB pads to make a solder joint.

Ingress Protection (IP): A rating system that measures a connector's sealing capabilities against dust and moisture.

Insertion Force: The force required to insert a connector housing into its final position in a printed circuit board or panel cutout.

Insertion Loss: 1) The loss in load power resulting from the insertion of a component, connector or device. 2) A measure of the attenuation of a device by determining the output of a system before and after the device is inserted into the system.

Insulation Displacement Technology (IDT): A wire termination technique in which an insulated wire is pressed into a terminal slot smaller than the conductor diameter, displacing the insulation, and forming an electrical contact between the terminal and the conductor.

Insulation Resistance: The electrical resistance of the insulating material between any pair of contacts, conductors or grounding devices in various combinations.

Interference: Disturbances of an electrical or electromagnetic nature that introduce undesirable responses into electronic equipment.

J

Jacket: Outermost layer of insulating material of a cable or wire.

Jackscrew: A screw attached to one half of a two-piece, multiple-contact connector and used to draw and secure both halves together and to separate them.

Jumper Cable: A short flat cable interconnecting two printed circuit boards or devices.

K

Keying: A mechanical arrangement of inserts and/or shell configurations (referred to as clocking in some instances) that prohibits the mating of mismatched plugs and receptacles. This allows connectors of the same size to be lined up, side-by-side, with no danger of making the wrong connection.

L

Leakage: The undesirable passage of current over the surface of, or through, an insulator.

Life Cycle: A test to determine the length of time before failure in a controlled, usually accelerated, environment.

Liquid Crystal Polymer (LCP): A type of plastic material of high crystallinity with excellent high-temperature applications, very high strength and excellent chemical resistance.

Loop Resistance: The total resistance of two conductors measured round trip from one end.

M

Mass Termination: A termination method, typically used with discrete wire or ribbon cable, in which two or more insulated conductors are simultaneously terminated to the same connector housing. Termination method is typically insulation displacement.

Mating/Unmating Force: The amount of force, measured in grams or pounds, required to join or separate a mated plug and receptacle.

Migration: The movement of atoms or molecules of a metal from one location to another that changes the properties of the metal.

MIL SPEC: Specific manufacturing, testing, and packaging requirements set by the U.S. military as indicated on an item by a military identification or MIL SPEC number.

Mismatch, Connector Impedance: Terminal or connector with a different impedance than the circuit or cable it is designed for.

Motherboard: A printed circuit board that is generally the main PCB in a system.

N

Non-compliant Press-fit Technology: A square pin pushed into a slightly undersized plated through hole on a PCB.

Normal Force: The force perpendicular to the contact interface. Does not include frictional forces, created from insertion to, or withdrawal from the connector housing.

O

Operating Temperature: The maximum and minimum ranges of temperatures at which a device is designed to operate at its rated current and voltage.

P

Panel Cutout: The hole, usually round or rectangular, cut in a panel for mounting a connector. May include holes for mounting screws or bolts.

Panel Mount: Method of fixing a connector half to a cut out in a board, panel or frame.

Parallel Bus: A bus that transfers eight or more bits of data simultaneously through several parallel lines.

Passive Device: A static device that requires no power for its intended functions.

Pitch: The nominal distance from center-to-center of adjacent conductors.

Plating: The overlaying of a thin coating of metal on metallic components to improve conductivity, provide for easy soldering, or prevent rusting or corrosion.

Plug: Usually the half of a two-piece multiple contact connector that contains the male contacts or the cable-side connector in an Input/Output configuration.

Polarization: Mechanical guide arrangement in a connector housing, shell or insert that ensures that connector halves are correctly aligned before they can be fully mated.

Polarizing Pin (Key): A pin or keying device on one half of a two-piece connector that mates with an appropriate hole on the other half during connector assembly to assure that only related connector halves can be assembled.

Positive Lock: A type of latch or locking mechanism that holds a die set in an installation tool, or connector housing, so that the parts cannot be accidentally unlocked or unmated.

Printed Circuit Board (PCB): An insulating base material, usually of rosin polymer, onto which interconnecting conductive strips have been printed, usually via an etching process.

Profile Height: The height of a connector, when mated to its header, that is above the PCB.

Protocol: In data transmission, a set of rules that specifies the timing, format, sequencing and error control of transmitted signals.

Pull Out Force: Force required to separate a cable from a connector by pulling them apart.

Q

Quick Disconnect: A type of terminal that permits rapid connection and disconnection to a flat blade terminal or terminal block.

R

Rated Temperature: The maximum temperature an electric component can operate at for extended periods without loss of its basic properties.

Rated Voltage: The maximum voltage an electric component can operate at for extended periods without undue degradation or causing a safety hazard.

Real Estate: Surface space on a PCB.

Receptacle: Usually the half of a two-piece multiple contact connector that contains the female contacts.

Resistance: Property of a conductor that determines the current produced by a given difference of potential.

RoHS: A European-driven standard regarding the absence of selective hazardous materials within systems and their respective components.

S

Selective Plating: The process of plating gold only in the mating areas (surfaces) of a contact.

Separation Force: See Engagement Force.

Shield: Device surrounding the portion of a connector that is used for attaching wires or cables to shield against radio frequency and electromagnetic interference, and/or protect connector wires or cable from mechanical damage.

Shield Effectiveness: The relative ability of a shield to screen out undesirable signals.

Shielded Cable: A cable in which a metallic layer is placed around a conductor or group of conductors to prevent electrostatic or electromagnetic interference between the enclosed wires and external fields. The shield may be the metallic sheath of the cable or a metallic layer inside of a non-metallic sheath.

Short Circuit: A break or interruption of current flow in an electrical circuit due to current shunted to a conjoining circuit.

Shunt: A device used to divert part of an electric current.

Single Beam: A stamped-and-formed contact where the female contact holds the male contact between itself and the housing wall.

Solder: An alloy that melts at relatively low temperature, and which is used to join or seal metals with higher melting points. Commonly used for connector terminations.

Solder Wicking: A capillary action that tends to draw solder or flux up into a connector from the PCB during the soldering process and can cause a short circuit.

Spice Modeling: Circuit response modeling and simulation per a given electrical excitation in order to judge the electrical and design capabilities of a system.

Stackable: Refers to placing symmetrical housings (assemblies) side-by-side or end-to-end and where the distance from the last contact in one assembly to the first contact in the next assembly is equal to the distance between any two contacts in the assembly itself.

Standoff: Tiny spacers built into housings to raise the housing from the surface of a printed circuit board.

Strain Relief: Technique involving methods of termination or installation, which reduces the transmission of mechanical stresses to the conductor termination.

Strand: One of the wires, or groups of wires, of any stranded conductor.

Strip Length: The length of insulation that must be removed from a cable prior to crimping.

Surface Mount Compatible (SMC): Through hole product made of high temperature material, thereby suitable for the IR or convection reflow soldering process.

Surface Mount Technology (SMT): The electrical connection of components to the surface of a conductive pattern without using component holes.

T

Tensile Strength: Greatest longitudinal stress that a substance can bear without pulling apart.

Terminal: A device that terminates a conductor to a post, stud, chassis or another conductor, or the like, to establish an electrical connection.

Termination Resistance: The opposition to current flow due to the mating interface of a connector and a header or to another connector.

Thermoplastic: A type of plastic that can be re-melted a number of times without any important change in properties.

Thermosetting Plastic: A type of plastic in which an irreversible chemical reaction takes place while it is being molded under heat and pressure.

Through-Hole Mounting: Electrical connection of components through drilled holes rather than attachment directly to the insulating material.

Tolerance: The upper and lower limits of variation from a component's nominal value.

Twisted Pair: A cable composed of two small gauge insulated conductors, twisted together without a common covering. The two conductors of a twisted pair are usually well insulated.

U

Underwriters Laboratories (UL): A U.S. organization that sets certain standards for connector testing.

Unmating Force: The force required to disconnect a male and female connector.

V

Void: A hole in a header that does not have a pin/terminal for polarization purposes.

W

Wiping: The translational action that occurs when contacts are mated with a sliding action. Wiping has the effect of removing small amounts of contamination from the contact surfaces, thus establishing better conductivity.

Wire Pull Out: The force required to separate a wire from a contact after termination.

Withdrawal Force: The force required to disconnect the two halves of a connector.

Z

ZIF: Zero Insertion Force. Usually describes a socket which permits the insertion of the component without the socket exerting any force on the leads of the component.

Order (EDP) No. Index

<i>Order No.</i>	<i>Page</i>	<i>Order No.</i>	<i>Page</i>	<i>Order No.</i>	<i>Page</i>	<i>Order No.</i>	<i>Page</i>
11-31-6356	F-8	19084-000X	A-12	19417-0XXX	G-4, G-16	38720-XXXX	E-58, E-64
19001-00XX	C-3	19085-000X	A-12	19418-00XX	G-5, G-6	38721-XXXX	E-60, E-62, E-66
19002-00XX	C-3	19095-0XXX	A-22	19419-00XX	G-5, G-6	38730-XXXX	E-67, E-68
19003-0XXX	C-2	19098-00XX	A-15	19420-00XX	G-4	38731-XXXX	E-70
19003-0133	C-2	19099-00XX	A-15	19421-000X	H-4	38733-64XX	E-74
19004-00XX	C-3	19115-00XX	A-15	19424-0002	H-6	38740-XXXX	E-69
19005-00XX	C-2, C-3	19118-0XXX	A-17	19425-000X	H-5	38741-660X	E-71
19006-00XX	C-4	19121-00XX	A-17	19426-000X	H-5	38760-01XX	E-72
19007-00XX	C-4	19127-00XX	A-17	19427-0XXX	G-7 to G-10	38770-01XX	E-72
19008-00XX	C-7	19129-00XX	A-16	19428-00XX	G-10 to G-12	38780-01XX	E-73
19008-0002	C-7, C-12	19131-00XX	A-16	19429-00XX	G-7	38969-00XX	E-71
19009-00XX	C-7, C-13	19139-00XX	A-16	19431-00XX	G-14, G-17	38980-1029	E-73
19011-00XX	C-6	19141-00XX	A-14, A-16	19432-00XX	G-14, G-15	39100-XXXX	E-50, E-51
19012-00XX	C-6	19144-00XX	A-14	19433-00XX	G-15, G-16	39357-00XX	E-33
19013-00XX	C-5	19154-00XX	B-5 to B-7	19434-000X	G-13	39371-00XX	E-28
19016-0XXX	C-8	19160-00XX	D-3, D-4	19435-0XXX	G-8	39372-00XX	E-29
19017-0XXX	C-8, C-11	19164-0XXX	A-4, A-5	19600-130X	C-3	39373-00XX	E-29
19018-00XX	C-9	19178-00XX	A-18	19602-00XX	C-5	39374-0XXX	E-28
19019-00XX	C-9, C-12	19179-00XX	A-18	19606-000X	C-2, C-3	39380-010X	E-39
19022-00XX	C-10	19183-00XX	A-18	19702-4XX1	A-22	39390-010X	E-42
19023-00XX	C-10	19189-00XX	B-7	19705-4XX1	C-14	39421-00XX	E-30
19024-000X	C-10	19193-0XXX	A-8, A-9, A-11, A-16, A-23	19705-4XX3	C-14	39422-000X	E-31
19025-00XX	C-11	19195-XXXX	A-25, B-2	19708-40XX	C-14	39425-00XX	E-31
19033-000X	A-20	19198-00XX	A-14, A-16	19711-4XXX	C-15	39426-000X	E-32
19034-000X	A-20	19199-00XX	B-5, B-6	19712-400X	C-14	39500-00XX	E-2
19035-00XX	A-20	19202-00XX	B-5 to B-7	19713-400X	C-15	39501-10XX	E-3
19036-000X	A-20	19203-0XXX	A-6, B-3, C-7	38002-XXXX	E-74	39502-10XX	E-3
19037-00XX	A-21	19204-00XX	B-7	38221-00XX	E-73	39503-20XX	E-2
19038-00XX	A-21	19205-00XX	B-4, B-6	38330-XXXX	H-9 to H-12	39503-30XX	E-2
19039-00XX	A-21	19206-00XX	B-4	38331-XXXX	H-10, H-11	39504-00XX	E-4
19043-00XX	C-6	19207-000X	B-4	38540-XXXX	H-12, H-13, H-15	39505-10XX	E-5
19045-XXXX	H-3, H-5	19211-000X	A-24	38541-XXXX	H-14	39506-10XX	E-5
19054-0XXX	A-7	19212-000X	A-24	38542-XXXX	H-13	39507-XXXX	E-4
19058-0XXX	A-8	19213-00XX	A-24	38610-XXXX	E-52	39510-00XX	E-7
19067-0XXX	A-10, A-11, A-23	19215-0XXX	B-4 to B-7	38631-XXXX	E-67	39511-10XX	E-8
19069-0380	A-12	19216-00XX	B-8	38700-XXXX	E-53	39512-10XX	E-8
19070-0XXX	A-7	19221-0XXX	A-19	38701-XXXX	E-55, E-56	39513-XXXX	E-7
19071-0XXX	A-9, A-11	19252-0XXX	D-5	38703-65XX	E-74	39514-00XX	E-9
19072-00XX	A-23	19252-0XXX	D-5	38704-4XXX	E-54	39515-10XX	E-10
19073-0XXX	A-8, A-23	19267-0XXX	D-6 to D-12	38704-4111	E-54	39516-10XX	E-10
19074-00XX	A-13	19268-0XXX	D-14, D-15	38706-00XX	E-72	39517-XXXX	E-9
19075-00XX	A-13	19269-0XXX	D-13	38710-0XXX	E-57, E-63	39520-00XX	E-12
19077-00XX	A-13	19270-00XX	D-16	38711-2XXX	E-61	39521-XXXX	E-13
19079-00XX	A-13	19401-1000	H-3	38711-5XXX	E-59	39522-XXXX	E-14
19080-000X	A-13	19402-XXXX	H-5, H-6	38711-6XXX	E-65	39523-XXXX	E-12
19081-000X	A-13	19403-XXXX	H-3 to H-5, H-7	38713-64XX	E-74	39524-00XX	E-17

Order (EDP) No. Index

<i>Order No.</i>	<i>Page</i>	<i>Order No.</i>	<i>Page</i>	<i>Order No.</i>	<i>Page</i>	<i>Order No.</i>	<i>Page</i>
39525-XXXX	E-18	39544-30XX	E-37	39991-0XXX	E-11	83422-90XX	F-4 to F-6
39526-XXXX	E-18	39880-XXXX	E-38, E-39, E-47 to E-49	62100-0900	F-8	83424-90XX	F-4 to F-6
39527-XXXX	E-17	39890-0XXX	E-34, E-45, E-46	62100-4100	F-8	83611-9XXX	F-2
39528-XXXX	E-15, E-16	39910-01XX	E-42	62100-4200	F-8	83612-9XXX	F-2
39530-00XX	E-22	39910-03XX	E-42	62200-8900	F-8	83614-9XXX	F-2
39531-XXXX	E-23	39920-0XXX	E-44	62200-9000	F-8	83619-9XXX	F-3
39532-XXXX	E-23	39930-0XXX	E-6	62201-9800	F-8	84700-000X	F-11 to F-13
39533-XXXX	E-22	39940-0XXX	E-21	62201-9900	F-8	84702-XXXX	F-9 to F-12
39534-00XX	E-26	39950-01XX	E-40	62202-0000	F-8	84727-100X	F-14
39535-XXXX	E-27	39960-0XXX	E-41	62202-0100	F-8	84728-100X	F-15
39536-XXXX	E-27	39970-0XXX	E-43	83000-XXXX	F-4, F-7	84729-000X	F-15, F-16
39537-XXXX	E-26	39980-0XXX	E-19, E-20	83411-9110	F-7	84730-0001	F-16
39538-XXXX	E-24, E-25	39981-0XXX	E-19	83414-9021	F-7	84732-000X	F-14
39543-XXXX	E-33, E-35 to E-37	39990-0XXX	E-11	83421-90XX	F-4 to F-6		

Solderless Terminals

Introduction to Solderless Terminals, Splices and Quick Disconnects	A-2 to A-3
Perma-Seal™	A-4 to A-5
Temp-Terms (High-Temperature Ring Tongue Terminals)	A-6
Ring Tongue Terminals	A-7 to A-13
Spade Terminals	A-14 to A-17
Hook Terminals	A-18
Copper Lugs	A-19
Snap Plugs and Receptacles	A-20 to A-21
Mil Spec Solderless Terminals	A-22 to A-23
Wire Pin Terminals	A-24
MagKrimp™	A-25

Solderless Terminals, Splices and Quick Disconnects

Barrel Styles



KRIMPTITE®

This is the basic Molex barrel style. It is noninsulated and features a quality, 1-piece design. It is also the most economical style and has the greatest variety of uses where special features are not required. The Krimptite is available in wire range 10 to 26 AWG (0.10 to 6.60mm²).



INSULKRIMP®

These terminals and splices feature a rigid insulation sleeve of polyvinyl chloride (PVC) affixed permanently to the Krimptite barrel (in 10 to 22 AWG) or the brazed-seam Versakrimp barrel (in 4/0 to 22 AWG). It attaches to the wire with 1 quick crimp and the insulation sleeve protects against vibration damage by preventing wire flex at the crimp point. The funnel entrance into the electrical barrel eliminates wire strand "hang up," increases crimping rates and enhances wire termination reliability. Wire range 4/0 to 22 AWG (0.10 to 117.00mm²).



VERSAKRIMP™

When the butted-seam Krimptite barrel is bonded with a special brazing alloy, it becomes a Versakrimp barrel. These brazed-seam barrel terminals and splices will not open under conditions of stress or wire pull. As versatile as it is tough, it can be crimped under most adverse conditions by many types of tooling. The Versakrimp is ideal for hard-to-crimp solid and stranded wires. It is available in wire range 4/0 to 22 AWG.



NYLAKRIMP®

This terminal was designed specifically for larger wire applications. The color-coded barrel is formed by affixing a permanent, rigid, color-coded nylon insulating sleeve to the barrel. The insulation has a funnel entrance into the electrical barrel that eliminates wire strand "fold back," increases crimping rates and enhances wire termination.

Nylakrimp terminals withstand continuous operating temperatures of -55 to 105°C (-67 to 221°F). Available in wire range 4/0 to 8 AWG.



AVIKRIMP®

This color-coded barrel style offers you the ultimate in high-performance terminal design and rugged construction. The Tin-plated Brass sleeve strengthens the barrel and secures the wire to protect against stress and high vibration. The color-coded nylon insulating sleeve extends beyond the metal support sleeve. A funnel ferrule wire entrance into the electrical barrel prevents wire strand "fold back" for increased crimping rates and added wire termination reliability in the standard barrel length. Wire range 10 to 26 AWG (0.10 to 6.60mm²).



PERMA-SEAL

This is the ultimate in terminations and splicing. The insulation is a nylon shrink tubing with an inner wall of hot-melt adhesive. After the wire is crimped, heat is applied and the insulation shrinks and melts to give the crimp area a complete environmental seal. Wire range 10 to 22 AWG (0.10 to 6.60mm²).



EYELET

Our color-coded eyelet terminals can be used in place of standard compression terminals because they are deep drawn from CDA-110 electrolytic tough pitch Copper stock and then Tin plated for corrosion resistance. Combined with seamless barrels and pad, these parts are extra tough and reliable.



OPEN BARREL STRIP

Quick Disconnects, Rings and Star Rings are available on metal "T" carried strip. These parts feature open barrels with an insulation support and are made of Brass.

94V-0 TERMINALS

These terminals are used extensively in the telecommunications industry. 94V-0 parts consist of a PVC-insulated Avikrimp part. The PVC insulation has a 94V-0 Flammability Rating and an Oxygen Index Rating above 28%. These terminals exceed all UL and Bellcore requirements. Contact the factory for more information.

Tongue Styles



RING

The basic tongue type. It is the safest and most reliable because it cannot be disconnected unless the screw is completely removed.



SPADE

The open tongue end is for rapid insertion on the mounting screw. The spade is usually used on free standing studs.



BLOCK SPADE

This tongue style is similar to the spade. However, note the longer and flatter sides. Block Spades are designed for use in terminal blocks.



SNAP SPADE

The spring-like tongue snaps around the screw like a Quick Disconnect and the terminal is locked into place until the mounting screw can be tightened down.



FLANGED SPADE

The turned up edges give this spade more safety and reliability. The flanges also give both a location and locking action that aid greatly in installation.



HOOK

This tongue type combines the security advantage of the ring with the easy-handling characteristics of the spade.



STAR RING

This tongue style is a ring with serrated edges that bite into the applied surface insuring a good connection or ground.

Solderless Terminals, Splices and Quick Disconnects



METAL STRIP

Quick Disconnects are available on a continuous metal carrier. They are made in the traditional "T" carrier.



MYLAR TAPE CARRIER

Most Molex terminals in the 2 to 26 AWG wire range can be tape-mounted.

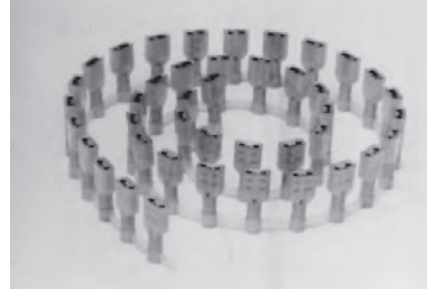

CONTINUOUS MOLDED STRIP

The fully insulated line of Quick Disconnects is also available in easy-to-identify, color-coded, continuous molded nylon strips.

Special reel sizes available upon request. For high-speed, volume production crimping, many companies in a wide range of industries have come to rely on Molex Metal Strip, Tape-Mounted, and Continuous Molded Strip terminals and automatic crimping presses to give them the highest quality end-product at the lowest applied cost.

Splices

Molex offers standard and special splices for nearly every type of wiring need.



BUTT SPLICE

Stripped wires are inserted from each end and "butt" in the center. Then a crimp at each end secures the connection.



NYLON CLOSED-END CONNECTOR

Used in a wide variety of situations to "pigtail" or tie together 2 or more wires.



MULTI-LOCK

These color-coded connectors make quick, reliable and pre-insulated splices without stripping, twisting, soldering or the need for special tools.



STEP DOWN BUTT SPLICE

The Step Down Butt Splice is the perfect solution when 2 wires need to be inserted in one end of a splice and a single wire in the other end.

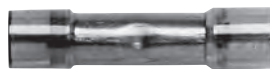

FUNNEL ENTRY BUTT SPLICE

In the past, the crimping of machine terminated butt splices has been difficult and nearly impossible if attempted on a piece of robotic equipment. Now, with our new Funnel Entry Butt Splice, the end that will be crimped by the crimping press is funneled to allow quick and easy wire insertion.



PARALLEL SPLICE

Stripped wires lie side-by-side in the splice and are secured by a single crimp in the middle.



AVIKRIMP® BUTT SPLICE

With the extra metal sleeve and nylon insulation, these splices should be used when heavy vibration is anticipated and a strong strain relief is needed.



WIRE TAP

The quick and easy way to splice into a wire.



WINDOW BUTT SPLICE

QPL'd to Mil-T-7928/5

Perma-Seal™ All-Weather Heat-Sealable Terminals and Splices

Perma-Seal terminals and splices provide a rugged, environmentally sealed connection for wire sizes 8 to 22 AWG that will insulate, seal and protect joints from physical abuse and abrasion, water, salt and other corrosive compounds.



Waterproof Adhesive Seal

Perma-Seal terminals and splices give you long-lasting, moisture-proof connections that withstand water, salt, condensation, corrosion and heat, which cause serious problems for conventional, unsealed splices. The inner wall of the heat-shrinkable Perma-Seal sleeve is lined with a special hot-melt adhesive that is inert at room temperature, permitting wires to be inserted easily into the splices and terminals. As the sleeve is heated, the adhesive melts and flows under pressure from the tubing. This action creates a voidless seal that repels moisture incursion even during pressure cycling, and stands up to some of the most rigorous

tests that can be applied to high-performance splices, including full immersion for 24 hours at room temperature in gasoline, battery acid, diesel fuel, motor oil, antifreeze, brake fluid, trichloroethylene and 5% soft water.

Tough and Durable

The tough sleeve of Perma-Seal splices and terminals resists abrasion and cutting. This protection helps to maintain the insulation and sealing properties even in the most hostile environments, not to mention an unbeatable strain relief.

Physical

Material: Terminal—Copper Alloy
Insulation—NiAc™
Plating: Tin

Terminals

Ring

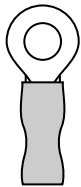

Ring

Wire Range AWG (mm ²)	Stud Size	Order No.		Lead-free
		Loose Piece	Mylar Tape	
18-22 (0.96-0.38)	6	19164-0085		Yes
	8	19164-0086	19164-0419	
	10	19164-0003	19164-0306	
	1/4	19164-0004	19164-0844	
	3/8	19164-0005	19164-0845	
14-16 (1.94-1.23)	6	19164-0032	19164-0310	
	8	19164-0033	19164-0311	
	10	19164-0034	19164-0312	
	1/4	19164-0026	19164-0308	
	5/16	19164-0027	19164-0309	
	3/8	19164-0020	19164-0307	
	1/2	19164-0061		
10-12 (5.01-3.09)	8	19164-0062		
	10	19164-0065	19164-0316	
	1/4	19164-0066	19164-0317	
	5/16	19164-0067	19164-0318	
	3/8	19164-0068		
	1/2	19164-0058		
8 (7.96)	10	19164-0080	19164-0602	
	1/4	19164-0081	19164-0603	
	5/16	19164-0083	19164-0605	
	3/8	19164-0082	19164-0604	
	1/2	19164-0457		

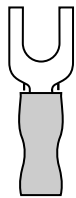

Spade

Spade

Wire Range AWG (mm ²)	Stud Size	Order No.	Lead-free
18-22 (0.96-0.38)	6	19164-0006	Yes
	8	19164-0007	
	10	19164-0008	
14-16 (1.94-1.23)	6	19164-0028	
	8	19164-0029	
	10	19164-0030	
10-12 (5.01-3.09)	6	19164-0069	
	8	19164-0070	
	10	19164-0072	
	1/4	19164-0073	



Hook

Hook

Wire Range AWG (mm ²)	Stud Size	Order No.s	Lead-free
14-16 (1.94-1.23)	10	19164-0021	Yes

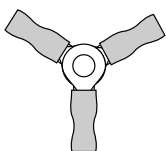

3-Way

3-Way

Wire Range AWG (mm ²)	Order No.	Lead-free
18-22 (0.96-0.38)	19164-0011	Yes
14-16 (1.94-1.23)	19164-0042	
10-12 (5.01-3.09)	19164-0074	

Perma-Seal™ All-Weather Heat-Sealable Splices



Butt Splice



Step Down Butt



Quick Disconnects

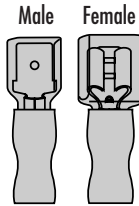

Quick Disconnect Couplers

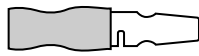

Snap Plug



Snap Plug Receptacle

Physical
Material: Splice—Copper
Insulation—NiAc™
Plating: Tin

Butt Splices

Wire Range AWG (mm ²)	Order No.		Lead-free
	Loose Piece	Mylar Tape	
18-22 (0.96-0.38)	19164-0013	19164-0014	Yes
14-16 (1.94-1.23)	19164-0044	19164-0045	
10-12 (5.01-3.09)	19164-0056	19164-0057	
8 (7.96)	19164-0079		

Step Down Butt

Wire Range AWG (mm ²)	Order No.	Lead-free
14-16 (1.94-1.23) to 18-22 (0.96-0.38)	19164-0043	Yes
10-12 (5.01-3.09) to 14-16 (1.94-1.23)	19164-0077	

Physical
Material: Terminal—Brass
Insulation—NiAc™
Plating: Tin

Quick Disconnects

Wire Range AWG (mm ²)	Fits Tab Size (in.)	Order No.	Lead-free
18-22 (0.96-0.38)	6.35 by 0.81 (.250 by .032)	19164-0012	Yes
14-16 (1.94-1.23)	6.35 by 0.81 (.250 by .032)	19164-0047	
10-12 (5.01-3.09)	6.35 by 0.81 (.250 by .032)	19164-0059	

Physical
Terminal Material: Male—Copper
Female—Brass
Insulation—NiAc™
Plating: Tin

Quick Disconnect Couplers

Wire Range AWG (mm ²)	Tab Size	Order No.				Lead-free
		Loose Piece		Mylar Tape		
		Male	Female	Male	Female	
18-22 (0.96-0.38)	6.35 by 0.81 (.250 by .032)	19164-0015	19164-0017	19164-0016	19164-0018	Yes
14-16 (1.94-1.23)	6.35 by 0.81 (.250 by .032)	19164-0048	19164-0050	19164-0049	19164-0051	
10-12 (5.01-3.09)	6.35 by 0.81 (.250 by .032)	19164-0075	19164-0076		19164-0305	

Physical
Material: Terminal—Copper Alloy
Insulation—NiAc™
Plating: Tin

Snap Plug

Wire Range AWG (mm ²)	Diameter	Order No.		Lead-free
		Loose Piece	Mylar Tape	
18-22 (0.96-0.38)	3.96 (.156)	19164-0010	19164-0807	Yes
14-16 (1.94-1.23)	3.96 (.156)	19164-0040	19164-0315	

Snap Plug Receptacle

Wire Range AWG (mm ²)	Diameter	Order No.		Lead-free
		Loose Piece	Mylar Tape	
18-22 (0.96-0.38)	3.96 (.156)	19164-0052		Yes
	4.57 (.180)	19164-0053		
14-16 (1.94-1.23)	3.96 (.156)	19164-0054	19164-0414	
	4.57 (.180)	19164-0055		

Simple Installation

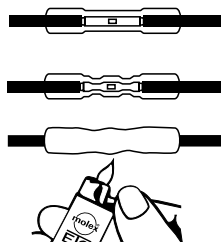

Select the correct splice size for the wire gauge. Strip the wires 7.60mm (.300") from the end and insert into the crimp barrel.

Making sure the wire end is properly seated, make the crimp connection using a tool designed for insulated splices.

Apply heat directly to the splice, working from the center out to the edges, using a hot air gun or other heat source, until the tubing shrinks and the adhesive flows. Allow to cool before inspecting splice and checking the integrity.

Perma-Seal only needs a temperature of 90°C to shrink.

Temp-Terms Ring Tongue Terminals

Reliable terminations for high-temperature applications. Extreme thermal environments for electrical and electronic circuitry demand Molex TEMP-TERMS. Their consistent, high quality and rugged reliability assure your product's proper performance even at temperatures up to 649°C (1200°F). TEMP-TERMS are designed and value-engineered for three

different high ambient temperature ranges: 343°, 483° and 649°C (650°, 900° and 1200°F, respectively). The terminals and splices in each range are fabricated from different materials to obtain maximum thermal performance at optimum initial and installed costs.

343°C Temp-Terms (650°F)



VersaKrimp™

Operating conditions in this maximum temperature range calls for Molex 343°C (650°F) TEMP-TERMS terminals and splices. Both terminals and splices are constructed of nickel-plated copper and are available in the VersaKrimp barrel style.

Physical
Material: Copper
Plating: Nickel

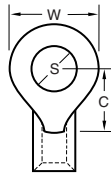

483°C Temp-Terms (900°F)



Krimptite™

Molex also offers a line of terminals designed to perform satisfactorily in ambient operating temperature ranges up to 483°C (900°F). These nickel-plated, steel alloy products are available in the butted seam, Krimptite™ barrel style. Ring tongue terminals cover the 22 through 10 AWG wire ranges to provide reliable performance time after time even in these hostile temperature environments.

Physical
Material: Steel
Plating: Nickel

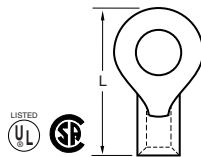

649°C Temp-Terms (1200°F)



Krimptite™

The ultimate in thermal reliability is afforded by the Molex 649°C (1200°F) TEMP-TERMS. The ring tongue terminals, which are fabricated from pure nickel, cover the 22 through 10 AWG wire range. These terminals have the butted seam Krimptite™ barrel.

Physical
Material: Nickel
Plating: Nickel

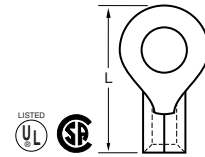
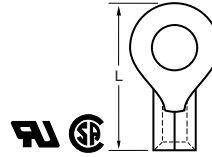

Basic Dimensions				343°C (650°F) VersaKrimp™			483°C (900°F) Krimptite™			649°C (1200°F) Krimptite™			Lead-free
Wire Range AWG (mm²)	Stud Size (S)	Maximum Width (W)	Minimum Clearance (C)	Order No.		Maximum Length (L)	Order No.		Maximum Length (L)	Order No.		Maximum Length (L)	
				Loose Piece	Mylar Tape		Loose Piece	Mylar Tape		Loose Piece	Mylar Tape		
18-22 (0.96-0.38)	5-6	6.7 (.264)	6.1 (.240)				19203-0483	19203-0011	16.8 (.660)				Yes
	8	6.7 (.264)	6.1 (.240)				19203-0485	19203-0014	16.8 (.660)				
	10	7.2 (.283)	6.1 (.240)				19203-0387	19203-0016	17.0 (.670)	19203-0034	19203-0035	.591 (15.0)	
	1/4	12.1 (.477)	9.8 (.386)				19203-0486	19203-0005	23.2 (.914)				
14-16 (1.94-1.23)	5-6	6.6 (.260)	5.3 (.209)				19203-0489	19203-0043	16.2 (.639)	19203-0077	19203-0078	.560 (14.2)	
		8.2 (.322)	7.0 (.275)				19203-0488	19203-0048	18.4 (.725)				
	8	8.2 (.322)	7.0 (.275)				19203-0470	19203-0050	18.4 (.725)	19203-0083	19203-0084	.640 (16.3)	
	10	8.2 (.322)	7.0 (.275)	19203-0063	19203-0064	16.3 (.640)	19203-0388	19203-0052	18.4 (.725)	19203-0085	19203-0086	.640 (16.3)	
10-12 (5.01-3.09)	1/4	12.1 (.477)	9.9 (.388)	19203-0148	19203-0058	21.2 (.837)	19203-0490	19203-0045	23.3 (.916)				
	5-6	9.8 (.385)	7.7 (.303)				19203-0493	19203-0092	19.9 (.785)				
		8	9.8 (.385)	7.7 (.303)	19203-0156	19203-0098	19.9 (.785)	19203-0494		19.9 (.785)			
	10	9.8 (.385)	7.7 (.303)	19203-0099	19203-0100	19.9 (.785)	19203-0389	19203-0094	19.9 (.785)	19203-0113	19203-0114	.785 (19.9)	
	1/4	13.7 (.540)	10.0 (.393)	19203-0182	19203-0101	24.2 (.952)	19203-0495	19203-0095	24.2 (.952)	19203-0161			
5/16	13.7 (.540)	10.0 (.393)				19203-0496	19203-0096	24.2 (.952)					
3/8	13.7 (.540)	14.4 (.566)	19203-0158	19203-0103	26.8 (1.056)								

IMPORTANT: The 343°C (650°F) TEMP-TERMS cataloged above represent only the more popular terminals and splices in the 22 through 10 AWG wire ranges. Other 343°C (650°F) TEMP-TERMS are available. Contact your Molex Customer Service Representative for more information.

Ring Tongue Terminals



Physical
Material: Copper

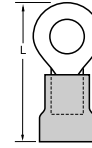
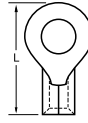
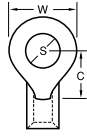

A
Solderless Terminals

Wire Range AWG (mm ²)	Stud Size (S)	Dimension		Krimpfit TM			InsulKrimp TM —PVC Insulation			Lead-free	
		Min. Clearance (C)	Max. Width (W)	Order No.		Max. Length (L)	Order No.		Max. Length (L)		
				Loose Piece	Mylar Tape		Loose Piece	Mylar Tape			
24-26 (0.22-0.13)	0	3.10 (.121)	3.80 (.150)	19069-0369	19069-0407	9.30 (.366)					
	2	3.10 (.121)	3.80 (.150)	19069-0370	19069-0371	9.30 (.366)					
		5.50 (.215)	5.40 (.213)	19069-0352	19069-0353	12.50 (.492)					
		5.50 (.215)	3.80 (.150)	19069-0358	19069-0405	11.70 (.460)					
	4	5.50 (.215)	5.40 (.213)	19069-0354	19069-0355	12.50 (.492)					
	6	5.50 (.215)	5.40 (.213)	19069-0356	19069-0357	12.50 (.492)					
		7.40 (.290)	6.60 (.260)	19069-0361	19069-0362	15.00 (.590)					
8	7.40 (.290)	6.60 (.260)	19069-0363	19069-0364	15.00 (.590)						
10	7.40 (.290)	6.60 (.260)	19069-0365	19069-0406	15.00 (.590)						
18-22 (0.96-0.38)	1-2	3.90 (.157)	6.00 (.235)	19069-0027	19069-0028	12.30 (.484)	19070-0005	19070-0006	18.00 (.709)		
	3-4	4.40 (.173)	5.00 (.197)	19069-0025	19069-0026	12.40 (.490)					
		3.90 (.157)	6.00 (.235)	19069-0029	19069-0030	12.30 (.484)	19070-0007	19070-0008	18.00 (.709)		
		6.10 (.240)	6.70 (.264)	19069-0052	19069-0053	14.80 (.582)	19070-0038	19070-0039	20.50 (.807)		
	5-6	3.90 (.157)	6.00 (.235)	19069-0031	19069-0032	12.30 (.484)	19070-0009	19070-0010	18.00 (.709)		
		6.10 (.240)	6.70 (.264)	19069-0054	19069-0055	14.80 (.582)	19070-0040	19070-0042	20.50 (.807)		
		7.60 (.300)	8.20 (.322)	19069-0033	19069-0034	17.00 (.671)	19070-0011	19070-0012	22.80 (.896)		
	8	6.10 (.240)	6.70 (.264)	19069-0056	19069-0057	14.80 (.582)	19070-0044	19070-0045	20.50 (.807)		
		7.60 (.300)	8.20 (.322)	19069-0035	19069-0036	17.00 (.671)	19070-0013	19070-0014	22.80 (.896)		
	10	6.10 (.240)	7.20 (.283)	19069-0061	19069-0062	15.00 (.591)	19070-0051	19070-0052	20.70 (.816)		
		7.60 (.300)	8.20 (.322)	19069-0037	19069-0038	17.00 (.671)	19070-0015	19070-0017	22.80 (.896)		
		9.80 (.386)	12.10 (.477)	19069-0040	19069-0041	21.20 (.835)	19070-0021	19070-0022	26.90 (1.060)		
	1/4	9.80 (.386)	12.10 (.477)	19069-0042	19069-0044	21.20 (.835)	19070-0023	19070-0024	26.90 (1.060)		
	5/16	9.80 (.386)	12.10 (.477)	19069-0045	19069-0046	21.20 (.835)	19070-0026	19070-0027	26.90 (1.060)		
	3/8	14.00 (.552)	13.80 (.544)	19069-0049	19069-0050	26.30 (1.034)	19070-0033	19070-0035	31.90 (1.259)		
	14-16 (1.94-1.23)	1-2	5.30 (.209)	6.60 (.260)	19069-0098	19069-0134	14.20 (.560)	19070-0065	19070-0066	19.90 (.785)	
		3-4	5.30 (.209)	6.00 (.260)	19069-0099	19069-0100	14.20 (.560)	19070-0067	19070-0068	19.90 (.785)	
5-6		5.30 (.209)	6.60 (.260)	19069-0101	19069-0102	14.20 (.560)	19070-0069	19070-0070	19.90 (.785)		
		7.00 (.275)	8.20 (.322)	19069-0112	19069-0113	16.30 (.640)	19070-0083	19070-0084	22.00 (.865)		
8		5.30 (.209)	6.60 (.260)	19069-0103	19069-0104	14.20 (.560)	19070-0071	19070-0072	19.90 (.785)		
		7.00 (.275)	8.20 (.322)	19069-0114	19069-0115	16.30 (.640)	19070-0086	19070-0087	22.00 (.865)		
		7.90 (.310)	8.90 (.352)	19069-0121	19069-0122	17.70 (.696)	19070-0099	19070-0100	23.40 (.921)		
10		7.00 (.275)	8.20 (.322)	19069-0116	19069-0117	16.30 (.640)	19070-0090	19070-0092	22.00 (.865)		
		7.90 (.310)	8.90 (.352)	19069-0123	19069-0124	17.70 (.696)	19070-0102	19070-0104	23.40 (.921)		
		9.90 (.388)	12.10 (.477)	19069-0105	19069-0106	21.20 (.837)	19070-0073	19070-0074	26.10 (1.062)		
1/4		9.90 (.388)	12.10 (.477)	19069-0107	19069-0108	21.20 (.837)	19070-0075	19070-0076	26.10 (1.062)		
5/16		9.90 (.388)	12.10 (.477)	19069-0109	19069-0110	21.20 (.837)	19070-0078	19070-0079	26.10 (1.062)		
		13.60 (.535)	13.80 (.544)	19069-0096	19069-0097	25.70 (1.010)	19070-0063	19070-0064	31.40 (1.235)		
3/8		13.60 (.535)	13.80 (.544)	19069-0093	19069-0094	25.70 (1.010)	19070-0059	19070-0061	31.40 (1.235)		
14-16 (1.94-1.23) Heavy Duty (Also suitable for 12 AWG)		5-6	7.70 (.303)	9.80 (.385)	19044-0161		19.90 (.785)	19054-0090	19054-0091	27.30 (1.076)	
		8	7.70 (.303)	9.80 (.385)	19044-0162		19.90 (.785)	19054-0092	19054-0093	27.30 (1.076)	
			7.70 (.303)	9.80 (.385)	19044-0163	19044-0164	19.90 (.785)	19054-0094	19054-0095	27.30 (1.076)	
	10	10.00 (.393)	13.70 (.540)	19044-0166		24.20 (.952)	19054-0096	19054-0021	31.60 (1.243)		
		10.00 (.393)	13.70 (.540)	19044-0167	19044-0023	24.20 (.952)	19054-0097		31.60 (1.243)		
	5/16	10.00 (.393)	13.70 (.540)	19044-0168	19044-0024	24.20 (.952)	19054-0098	19054-0099	31.60 (1.243)		
		11.80 (.466)	13.70 (.540)	19044-0186	19044-0187	26.80 (1.056)			31.60 (1.243)		
	3/8	11.80 (.466)	13.70 (.540)	19044-0184	19044-0185	26.80 (1.056)	19054-0126	19054-0127	34.20 (1.347)		
		15.50 (.611)	19.30 (.760)	19044-0140		32.50 (1.280)	19054-0066	19054-0068	39.90 (1.571)		
	7/16	15.50 (.611)	19.30 (.760)	19044-0142	19044-0229	32.50 (1.280)	19054-0070	19054-0071	39.90 (1.571)		
1/2	15.50 (.611)	19.30 (.760)	19044-0137	19044-0138	32.50 (1.280)	19054-0063	19054-0064	39.90 (1.571)			
10-12(5.00-3.30)	5-6	7.80 (.306)	7.40 (.292)	19069-0230	19069-0232	18.80 (.741)	19070-0143	19070-0144	26.20 (1.032)		
		7.70 (.303)	9.80 (.385)	19069-0202		19.90 (.785)	19070-0119	19070-0120	27.30 (1.076)		
	8	7.80 (.306)	7.40 (.292)	19069-0233	19069-0235	18.80 (.741)	19070-0145	19070-0146	26.20 (1.032)		
		7.70 (.303)	9.80 (.385)	19069-0205	19069-0208	19.90 (.785)	19070-0121	19070-0122	27.30 (1.076)		
		7.70 (.303)	9.80 (.385)	19069-0209	19069-0212	19.90 (.785)	19070-0123	19070-0125	27.30 (1.076)		
	10	10.00 (.393)	13.70 (.540)	19069-0217	19069-0218	24.20 (.952)	19070-0130	19070-0131	31.60 (1.243)		
		14.40 (.566)	15.20 (.598)	19069-0236		26.80 (1.056)					
		10.00 (.393)	13.70 (.540)	19069-0219	19069-0221	24.20 (.952)	19070-0132	19070-0133	31.60 (1.243)		
	1/4	14.40 (.566)	15.20 (.598)	19069-0238	19069-0240	26.80 (1.056)	19070-0150	19070-0151	34.20 (1.347)		
		10.00 (.393)	13.70 (.540)	19069-0223	19069-0225	24.20 (.952)	19070-0136	19070-0137	31.60 (1.243)		
	5/16	14.40 (.566)	15.20 (.598)	19069-0244	19069-0246	26.80 (1.056)	19070-0155	19070-0156	34.20 (1.347)		
		14.40 (.566)	15.20 (.598)	19069-0241	19069-0243	26.80 (1.056)	19070-0153	19070-0154	34.20 (1.347)		
	3/8	15.50 (.611)	19.30 (.760)	19069-0196	19069-0145	32.50 (1.280)			39.90 (1.571)		
		15.50 (.611)	19.30 (.760)	19069-0198	19069-0146	32.50 (1.280)	19070-0115	19070-0116	39.90 (1.571)		
	7/16	15.50 (.611)	19.30 (.760)	19069-0192	19069-0194	32.50 (1.280)	19070-0109	19070-0110	39.90 (1.571)		

Yes



Ring Tongue Terminals



Physical
Material: Copper

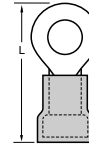
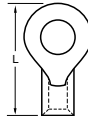
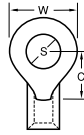

Solderless Terminals

Wire Range AWG (mm ²)	Stud Size (S)	Dimension		VersaKrimp™			Avikrimp™—Nylon Insulation			Lead-free	
		Min. Clearance (C)	Max. Width (W)	Order No.		Max. Length (L)	Order No.		Max. Length (L)		
				Loose Piece	Mylar Tape		Loose Piece	Mylar Tape			
18-22 (0.96-0.38)	1-2	3.90 (.157)	6.00 (.235)				19073-0005	19073-0006	18.00 (.709)	Yes	
	3-4	4.40 (.173)	5.00 (.197)				19073-0003	19073-0004	18.20 (.715)		
		3.90 (.157)	6.00 (.235)	19193-0007	19193-0008	12.30 (.484)	19073-0007	19073-0008	18.00 (.709)		
		6.10 (.240)	6.70 (.264)				19073-0036	19073-0037	20.50 (.807)		
	5-6	3.90 (.157)	6.00 (.235)	19193-0009	19193-0011	12.30 (.484)	19073-0009	19073-0010	18.00 (.709)		
		6.10 (.240)	6.70 (.264)	19193-0034	19193-0035	14.80 (.582)	19073-0038	19073-0040	20.50 (.807)		
		7.60 (.300)	8.20 (.322)	19193-0012	19193-0013	17.00 (.671)	19073-0011	19073-0012	22.80 (.896)		
	8	6.10 (.240)	6.70 (.264)	19193-0036	19193-0037	14.80 (.582)	19073-0042	19073-0043	20.50 (.807)		
		7.60 (.300)	8.20 (.322)	19193-0014	19193-0015	17.00 (.671)	19073-0013	19073-0015	22.80 (.896)		
		6.10 (.240)	7.20 (.283)	19193-0041	19193-0042	15.00 (.591)	19073-0049	19073-0050	20.70 (.816)		
	10	7.60 (.300)	8.20 (.322)	19193-0016	19193-0017	17.00 (.671)	19073-0017	19073-0019	22.80 (.896)		
		1/4	9.80 (.386)	12.10 (.477)	19193-0021	19193-0022	21.20 (.835)	19073-0024	19073-0026		26.90 (1.060)
		5/16	9.80 (.386)	12.10 (.477)	19193-0023	19193-0024	21.20 (.835)	19073-0027	19073-0028		26.90 (1.060)
		3/8	14.00 (.552)	13.80 (.544)				19073-0032	19073-0033		31.90 (1.259)
14-16 (1.94-1.23)	1-2	5.30 (.209)	6.60 (.260)	19193-0062	19193-0063	14.20 (.560)				Yes	
	3-4	5.30 (.209)	6.00 (.260)				19073-0065	19073-0066	22.30 (.880)		
		5.30 (.209)	6.60 (.260)				19073-0067	19073-0070	22.30 (.880)		
	5-6	7.00 (.275)	8.20 (.322)	19193-0078	19193-0079	16.30 (.640)	19073-0083	19073-0084	22.30 (.880)		
		5.30 (.209)	6.60 (.260)				19073-0072	19073-0073	22.30 (.880)		
	8	7.00 (.275)	8.20 (.322)	19193-0080	19193-0081	16.30 (.640)	19073-0085	19073-0086	22.30 (.880)		
		7.90 (.310)	8.90 (.352)	19193-0089	19193-0090	17.70 (.696)	19073-0094	19073-0096	23.80 (.936)		
		7.00 (.275)	8.20 (.322)	19193-0082	19193-0083	16.30 (.640)	19073-0087	19073-0088	22.30 (.880)		
	10	7.90 (.310)	8.90 (.352)	19193-0091	19193-0092	17.70 (.696)	19073-0097	19073-0099	23.80 (.936)		
		9.90 (.388)	12.10 (.477)				19073-0074	19073-0075	27.40 (1.077)		
		1/4	9.90 (.388)	12.10 (.477)	19193-0072	19193-0073	21.20 (.837)	19073-0076	19073-0077		27.40 (1.077)
	5/16	9.90 (.388)	12.10 (.477)	19193-0074	19193-0075	21.20 (.837)	19073-0079	19073-0080	27.40 (1.077)		
		13.60 (.535)	13.80 (.544)				19073-0061	19073-0062	31.80 (1.250)		
		3/8	13.60 (.535)	13.80 (.544)	19193-0057	19193-0058	25.70 (1.010)	19073-0059	19073-0060		31.80 (1.250)
14-16 (1.94-1.23) Heavy Duty (Also suitable for 12 AWG)	8	7.70 (.303)	9.80 (.385)				19058-0041		27.70 (1.091)		
	10	7.70 (.303)	9.80 (.385)				19058-0047	19058-0050	27.70 (1.091)		
		10.00 (.393)	13.70 (.540)					19058-0060	32.00 (1.258)		
	1/4	10.00 (.393)	13.70 (.540)				19058-0063	19058-0068	32.00 (1.258)		
	5/16	10.00 (.393)	13.70 (.540)				19058-0072	19058-0077	32.00 (1.258)		
	3/8	11.80 (.466)	15.20 (.598)				19058-0117	19058-0119	34.60 (1.362)		
	7/16	15.50 (.611)	19.30 (.760)				19058-0026		40.30 (1.586)		
	1/2	15.50 (.611)	19.30 (.760)				19058-0016		40.30 (1.586)		

Wire Range AWG (mm ²)	Stud Size (S)	Dimension		VersaKrimp™			Avikrimp™—Nylon Insulation					Lead-free
		Min. Clearance (C)	Max. Width (W)	Order No.		Max. Length (L)	Order No.				Max. Length (L)	
				Loose Piece	Mylar Tape		Loose Piece	Mylar Tape	Expanded Flare*	Expanded Flare on Mylar Tape*		
10-12 (5.01-3.09)	5-6	7.80 (.306)	7.40 (.292)	19193-0128	19193-0129	18.80 (.741)	19073-0216	19073-0218	19073-0220	19073-0221	27.00 (1.047)	Yes
		7.70 (.303)	9.80 (.385)	19193-0103	19193-0105	19.90 (.785)	19073-0160	19073-0162	19073-0163	19073-0164	27.70 (1.091)	
	8	7.80 (.306)	7.40 (.292)	19193-0130	19193-0131	18.80 (.741)	19073-0222	19073-0224	19073-0225	19073-0226	27.00 (1.047)	
		7.70 (.303)	9.80 (.385)	19193-0106	19193-0108	19.90 (.785)	19073-0165	19073-0167	19073-0168	19073-0169	27.70 (1.091)	
	10	7.70 (.303)	9.80 (.385)	19193-0109	19193-0111	19.90 (.785)	19073-0170	19073-0172	19073-0173	19073-0174	27.70 (1.091)	
		10.00 (.393)	13.70 (.540)	19193-0114	19193-0115	24.20 (.952)	19073-0179	19073-0180	19073-0181	19073-0184	32.00 (1.258)	
		11.80 (.466)	15.20 (.598)				19073-0227	19073-0228	19073-0229	19073-0230	34.60 (1.362)	
	1/4	10.00 (.393)	13.70 (.540)	19193-0116	19193-0118	24.20 (.952)	19073-0188	19073-0190	19073-0191	19073-0194	32.00 (1.258)	
		11.80 (.466)	15.20 (.598)	19193-0134	19193-0135	26.80 (1.056)	19073-0231	19073-0232	19073-0233	19073-0234	34.60 (1.362)	
	5/16	10.00 (.393)	13.70 (.540)	19193-0120	19193-0122	24.20 (.952)	19073-0200	19073-0201	19073-0202	19073-0205	32.00 (1.258)	
		11.80 (.466)	15.20 (.598)	19193-0141	19193-0142	26.80 (1.056)	19073-0242	19073-0243	19073-0244	19073-0245	34.60 (1.362)	
	3/8	11.80 (.466)	15.20 (.598)	19193-0137	19193-0139	26.80 (1.056)	19073-0236	19073-0237	19073-0238	19073-0239	34.60 (1.362)	
		15.50 (.611)	19.30 (.760)	19193-0097		32.50 (1.280)						
	7/16	15.50 (.611)	19.30 (.760)	19193-0099	19193-0100	32.50 (1.280)						
	1/2	15.50 (.611)	19.30 (.760)	19193-0094	19193-0095	32.50 (1.280)	19073-0145	19073-0146	19073-0147		40.30 (1.586)	

* For use with heavier wire insulation. Max. wire insulation 6.50mm (.255").



Ring Tongue Terminals



Physical
Material: Copper

A
Solderless Terminals

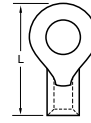
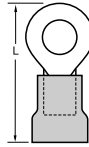
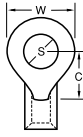

Wire Range AWG (mm ²)	Stud Size (S)	Dimension		InsulKrimp™ - PVC Insulation			VersaKrimp™			Lead-free
		Min. Clearance (C)	Max. Width (W)	Order No.		Max. Length (L)	Order No.		Max. Length (L)	
				Loose Piece	Mylar Tape		Loose Piece	Mylar Tape		
8 (7.96)	6	9.40 (.368)	9.90 (.389)	19071-0176	19071-0177	31.80 (1.252)	19193-0198	19193-0199	23.80 (.937)	Yes
	8	9.40 (.368)	12.30 (.483)	19071-0134	19071-0135	33.00 (1.299)	19193-0146	19193-0148	25.00 (.984)	
		9.40 (.368)	9.90 (.389)	19071-0178	19071-0179	31.80 (1.252)	19193-0200	19193-0201	23.80 (.937)	
	10	9.40 (.368)	12.30 (.483)	19071-0136	19071-0139	33.00 (1.299)	19193-0149	19193-0151	25.00 (.984)	
		11.00 (.433)	15.30 (.603)	19071-0146	19071-0147	36.10 (1.421)	19193-0159	19193-0162	28.10 (1.106)	
	1/4	9.40 (.368)	9.90 (.389)	19071-0180	19071-0181	31.80 (1.252)	19193-0202	19193-0203	23.80 (.937)	
		9.40 (.368)	12.30 (.483)	19071-0140	19071-0143	33.00 (1.299)	19193-0152	19193-0155	28.10 (1.106)	
		11.00 (.433)	15.30 (.603)	19071-0148	19071-0149	36.10 (1.421)	19193-0163	19193-0166	28.10 (1.106)	
		9.30 (.368)	9.90 (.389)	19071-0182	19071-0184	31.80 (1.252)	19193-0204	19193-0205	23.80 (.937)	
	5/16	9.40 (.368)	12.30 (.483)	19071-0144	19071-0145	33.00 (1.299)	19193-0157	19193-0158	25.00 (.984)	
		11.00 (.433)	15.30 (.603)	19071-0153	19071-0155	36.10 (1.421)	19193-0171	19193-0174	28.10 (1.106)	
	3/8	11.00 (.433)	15.30 (.603)	19071-0150	19071-0152	36.10 (1.421)	19193-0167	19193-0170	28.10 (1.106)	
		15.60 (.616)	21.00 (.825)	19071-0162		42.60 (1.718)	19193-0184		35.60 (1.403)	
	7/16	15.60 (.616)	21.00 (.825)	19071-0166		42.60 (1.718)	19193-0187	19193-0189	35.60 (1.403)	
		1/2	15.60 (.616)	21.00 (.825)	19071-0334	19071-0160	42.60 (1.718)	19193-0179	19193-0181	
	5/8	15.60 (.616)	21.00 (.825)	19071-0164	19071-0165	42.60 (1.718)	19193-0186		35.60 (1.403)	
25.20 (.993)		29.00 (1.140)	19071-0173		57.20 (2.253)	19193-0195		49.20 (1.938)		
3/4	25.20 (.993)	29.00 (1.140)				19193-0192		49.20 (1.938)		
	13.20 (.518)	16.40 (.645)				19193-0206		32.20 (1.268)		
6 (13.48)	8	13.20 (.518)	12.30 (.485)	19071-0218	19071-0219	40.50 (1.593)	19193-0243	19193-0244	30.20 (1.188)	
		13.20 (.518)	16.40 (.645)	19071-0188	19071-0189	42.50 (1.673)	19193-0209	19193-0211	32.20 (1.268)	
	10	13.20 (.518)	12.30 (.485)	19071-0221	19071-0223	40.50 (1.593)	19193-0245	19193-0247	30.20 (1.188)	
		15.50 (.610)	21.30 (.837)				19193-0225		37.00 (1.46)	
	1/4	13.20 (.518)	16.40 (.645)	19071-0190	19071-0192	42.50 (1.673)	19193-0212	19193-0215	32.20 (1.268)	
		15.50 (.610)	21.30 (.837)				19193-0229		37.00 (1.456)	
		13.20 (.518)	12.30 (.485)	19071-0225	19071-0227	40.50 (1.593)	19193-0248	19193-0250	30.20 (1.188)	
		25.20 (.991)	28.90 (1.136)				19193-0237		50.60 (1.99)	
	5/16	13.20 (.518)	16.40 (.645)	19071-0196	19071-0198	42.50 (1.673)	19193-0219	19193-0222	32.20 (1.268)	
		13.20 (.518)	12.30 (.485)	19071-0229	19071-0230	40.50 (1.593)	19193-0251	19193-0253	30.20 (1.188)	
		13.20 (.518)	16.40 (.645)	19193-0206		32.20 (1.268)				
		15.50 (.610)	21.30 (.837)				19193-0232		37.00 (1.46)	
	3/8	25.20 (.991)	28.90 (1.136)				19193-0240		50.60 (1.99)	
		13.20 (.518)	16.40 (.645)	19071-0193	19071-0195	42.50 (1.673)	19193-0216	19193-0218	32.20 (1.268)	
	7/16	15.50 (.610)	21.30 (.837)				19193-0230	19193-0231	37.00 (1.456)	
		25.20 (.991)	28.90 (1.136)				19193-0239		50.60 (1.99)	
1/2	15.50 (.610)	21.30 (.837)	19071-0208		47.30 (1.861)	19193-0234		37.00 (1.456)		
	25.20 (.991)	28.90 (1.136)				19193-0242		50.60 (1.99)		
5/8	13.20 (.518)	16.40 (.645)				19193-0223		32.20 (1.27)		
	15.50 (.610)	21.30 (.837)	19071-0201		47.30 (1.861)	19193-0226	19193-0228	37.00 (1.456)		
3/4	25.20 (.991)	28.90 (1.136)				19193-0236		50.60 (1.99)		
	15.50 (.610)	21.30 (.837)				19193-0233		37.00 (1.456)		
4 (21.28)	10	25.20 (.991)	28.90 (1.136)	19071-0212		50.60 (1.991)	19193-0238		50.60 (1.991)	
		13.40 (.527)	17.30 (.680)	19071-0231		46.70 (1.840)	19193-0254	19193-0257	34.50 (1.357)	
	1/4	13.40 (.527)	12.40 (.490)	19071-0250	19071-0252	44.30 (1.744)	19193-0273	19193-0274	32.00 (1.261)	
		13.40 (.527)	17.30 (.680)	19071-0237		46.70 (1.840)	19193-0261	19193-0263	34.50 (1.357)	
	5/16	13.40 (.527)	12.40 (.490)	19071-0253	19071-0254	44.30 (1.744)	19193-0275	19193-0277	32.00 (1.261)	
		13.40 (.527)	17.30 (.680)	19071-0243	19071-0246	46.70 (1.840)	19193-0267	19193-0269	34.50 (1.357)	
	3/8	13.40 (.527)	12.40 (.490)				19193-0278	19193-0280	33.00 (1.261)	
		13.40 (.527)	17.30 (.680)	19071-0240		46.70 (1.840)	19193-0264	19193-0266	34.50 (1.357)	
	1/2	25.30 (.996)	22.90 (.900)				19193-0283		49.10 (1.935)	
		13.40 (.527)	17.30 (.680)	19071-0234		46.70 (1.840)	19193-0258	19193-0260	34.50 (1.357)	
	5/8	25.30 (.996)	22.90 (.900)				19193-0281		49.10 (1.935)	
		25.30 (.996)	22.90 (.900)				19193-0285		49.10 (1.935)	
	3/4	25.30 (.996)	32.40 (1.275)				19193-0293		53.90 (2.123)	
		25.30 (.996)	32.40 (1.275)				19193-0289		53.90 (2.123)	



Ring Tongue Terminals

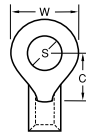

Physical
Material: Copper

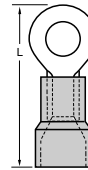

Solderless Terminals

A

Wire Range AWG (mm ²)	Stud Size (S)	Dimension		NylaKrimp™- Nylon Insulation			Lead-free
		Minimum Clearance (C)	Maximum Width (W)	Order No.		Maximum Length (L)	
				Loose Piece	Mylar Tape		
8 (7.96)	6	9.40 (.368)	9.90 (.389)			34.30 (1.352)	Yes
	8	9.40 (.368)	12.30 (.483)	19067-0003	19067-0005	35.50 (1.399)	
		9.40 (.368)	9.90 (.389)	19067-0037	19067-0038	34.30 (1.352)	
	10	9.40 (.368)	12.30 (.483)	19067-0006	19067-0007	35.50 (1.399)	
		11.00 (.433)	15.30 (.603)	19067-0016	19067-0017	38.60 (1.521)	
	1/4	9.40 (.368)	9.90 (.389)	19067-0039	19067-0040	34.30 (1.352)	
		9.40 (.368)	12.30 (.483)	19067-0008	19067-0011	35.50 (1.399)	
		11.00 (.433)	15.30 (.603)	19067-0018	19067-0019	38.60 (1.521)	
		9.30 (.368)	9.90 (.389)	19067-0041	19067-0042	34.30 (1.352)	
	5/16	9.40 (.368)	12.30 (.483)	19067-0012	19067-0013	35.50 (1.399)	
		11.00 (.433)	15.30 (.603)	19067-0025	19067-0026	38.60 (1.521)	
	3/8	11.00 (.433)	15.30 (.603)	19067-0022	19067-0024	38.60 (1.521)	
		15.60 (.616)	21.00 (.825)	19067-0030		46.20 (1.818)	
	7/16	11.00 (.433)	15.30 (.603)	19067-0128	19067-0027	38.60 (1.521)	
		15.60 (.616)	21.00 (.825)	19067-0031		46.20 (1.818)	
	1/2	15.60 (.616)	21.00 (.825)	19067-0028		46.20 (1.818)	
		25.20 (.993)	29.00 (1.140)	19067-0032		59.80 (2.353)	
	5/8	15.60 (.616)	21.00 (.825)	19067-0129		46.20 (1.818)	
25.20 (.993)		29.00 (1.140)	19067-0034		59.80 (2.353)		
3/4	25.20 (.993)	29.00 (1.140)	19067-0033		59.80 (2.353)		
6 (13.48)	8	13.20 (.518)	12.30 (.485)	19067-0067	19067-0068	41.20 (1.623)	
	10	13.20 (.518)	16.40 (.645)	19067-0045	19067-0046	43.30 (1.703)	
		13.20 (.518)	12.30 (.485)	19067-0069	19067-0070	41.20 (1.623)	
	1/4	13.20 (.518)	16.40 (.645)	19067-0047	19067-0048	43.30 (1.703)	
		13.20 (.518)	12.30 (.485)	19067-0071	19067-0072	41.20 (1.623)	
	5/16	13.20 (.518)	16.40 (.645)	19067-0055	19067-0056	43.30 (1.703)	
		13.20 (.518)	12.30 (.485)	19067-0073	19067-0074	41.20 (1.623)	
	3/8	13.20 (.518)	16.40 (.645)	19067-0052	19067-0053	43.30 (1.703)	
		15.50 (.610)	21.30 (.837)	19067-0063		48.00 (1.891)	
	7/16	13.20 (.518)	16.40 (.645)	19067-0059	19067-0060	43.30 (1.703)	
		15.50 (.610)	21.30 (.837)	19067-0065		36.20 (1.426)	
	1/2	15.50 (.610)	21.30 (.837)	19067-0061		36.20 (1.426)	
5/8	15.50 (.610)	21.30 (.837)					
4 (21.28)	10	13.40 (.527)	17.30 (.680)				
		13.40 (.527)	12.40 (.490)	19067-0081		46.50 (1.832)	
	1/4	13.40 (.527)	17.30 (.680)	19067-0077		49.00 (1.928)	
		13.40 (.527)	12.40 (.490)	19067-0082		46.50 (1.832)	
	5/16	13.40 (.527)	17.30 (.680)	19067-0079	19067-0141	49.00 (1.928)	
		13.40 (.527)	12.40 (.490)	19067-0084		46.50 (1.832)	
	3/8	13.40 (.527)	17.30 (.680)	19067-0078		49.00 (1.928)	
	7/16	13.40 (.527)	17.30 (.680)	19067-0080		49.00 (1.928)	
		13.40 (.527)	17.30 (.680)	19067-0076		49.00 (1.928)	
	1/2	25.30 (.996)	22.90 (.900)	19067-0085		63.70 (2.506)	
		25.30 (.996)	22.90 (.900)	19067-0087		63.70 (2.506)	
	5/8	25.30 (.996)	32.40 (1.275)	19067-0089		68.40 (2.694)	
25.30 (.996)		32.40 (1.275)	19067-0088		68.40 (2.694)		

Ring Tongue Terminals



Physical
Material: Copper

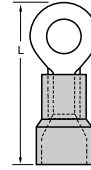
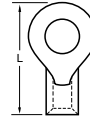
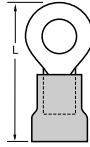
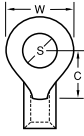

A
Solderless Terminals

Wire Range AWG (mm ²)	Stud Size (S)	Dimension		InsulKrimp™ - PVC Insulation		VersaKrimp™		Funnel Entry NylaKrimp™ - Nylon Insulation		Lead-free
		Minimum Clearance (C)	Maximum Width (W)	Loose Piece Order No.	Maximum Length (L)	Loose Piece Order No.	Maximum Length (L)	Loose Piece Order No.	Maximum Length (L)	
2 (33.70)	10	17.90 (.703)	16.40 (.645)	19071-0279	53.20 (2.093)	19193-0303	40.20 (1.583)	19067-0095	55.50 (2.186)	Yes
	1/4	17.90 (.703)	22.30 (.879)	19071-0273	56.10 (2.210)	19193-0297	43.20 (1.700)			
		17.90 (.703)	16.40 (.645)	19071-0281	53.20 (2.093)	19193-0305	40.20 (1.583)	19067-0096	55.50 (2.186)	
	5/16	17.90 (.703)	22.30 (.879)			19193-0299	43.20 (1.700)	19067-0093	58.50 (2.303)	
		17.90 (.703)	16.40 (.645)	19071-0285	53.20 (2.093)	19193-0309	40.20 (1.583)	19067-0098	55.50 (2.186)	
	3/8	17.90 (.703)	22.30 (.879)			19193-0298	43.20 (1.700)	19067-0092	58.50 (2.303)	
		17.90 (.703)	16.40 (.645)	19071-0283	53.20 (2.093)	19193-0307	40.20 (1.583)	19067-0097	55.50 (2.186)	
	7/16	17.90 (.703)	22.30 (.879)			19193-0302	43.20 (1.700)	19067-0094	58.50 (2.303)	
	1/2	17.90 (.703)	22.30 (.879)	19071-0272	56.10 (2.210)	19193-0296	43.20 (1.700)	19067-0090	58.50 (2.303)	
	5/8	17.90 (.703)	22.30 (.879)	19071-0277	56.10 (2.210)	19193-0301	43.20 (1.700)	19067-0130	58.50 (2.303)	
25.10 (.990)		32.30 (1.270)			19193-0611	55.40 (2.183)	19067-0100	70.80 (2.786)		
3/4	25.10 (.990)	32.30 (1.270)			19193-0320	55.40 (2.183)	19067-0099	70.80 (2.786)		
1/0 (52.95)	1/4	19.10 (.750)	21.30 (.840)	19071-0303	66.80 (2.630)	19193-0330	48.80 (1.920)			
	5/16	19.10 (.750)	21.30 (.840)	19071-0306	66.80 (2.630)	19193-0333	48.80 (1.920)	19067-0104	66.80 (2.628)	
		19.10 (.750)	21.30 (.840)	19071-0305	66.80 (2.630)	19193-0331	48.80 (1.920)			
	3/8	19.10 (.750)	22.90 (.902)			19193-0612	49.60 (1.951)	19067-0101	67.50 (2.659)	
		32.60 (1.282)	32.40 (1.277)					19067-0107	85.80 (3.379)	
	7/16	19.10 (.750)	22.90 (.902)	19071-0302	67.60 (2.661)	19193-0329	49.60 (1.951)	19067-0102	67.50 (2.659)	
	1/2	19.10 (.750)	22.90 (.902)			19193-0325	49.60 (1.951)			
		32.60 (1.282)	32.40 (1.277)					19067-0105	67.50 (2.659)	
	5/8	32.60 (1.282)	32.40 (1.277)					19067-0108	67.50 (2.659)	
	3/4	32.60 (1.282)	32.40 (1.277)					19067-0106	67.50 (2.659)	
2/0 (67.39)	1/4	19.60 (.770)	24.10 (.948)			19193-0342	51.30 (2.019)	19067-0110	69.30 (2.727)	
	5/16	19.60 (.770)	24.10 (.948)	19071-0312	67.40 (2.654)	19193-0346	51.30 (2.019)	19067-0112	69.30 (2.727)	
	3/8	19.60 (.770)	24.10 (.948)	19071-0311	67.40 (2.654)	19193-0345	51.30 (2.019)	19067-0111	69.30 (2.727)	
	7/16	19.60 (.770)	24.10 (.948)	19071-0313	67.40 (2.654)	19193-0348	51.30 (2.019)			
		19.60 (.770)	24.10 (.948)			19193-0341	51.30 (2.019)	19067-0109	69.30 (2.727)	
	1/2	32.40 (1.275)	32.40 (1.275)	19071-0314	84.40 (3.322)	19193-0350	68.20 (2.687)	19067-0114	86.20 (3.395)	
		32.40 (1.275)	32.40 (1.275)	19071-0340	84.40 (3.322)	19193-0352	68.20 (2.687)			
	3/4	32.40 (1.275)	32.40 (1.275)	19071-0339	84.40 (3.322)	19193-0351	68.20 (2.687)			
3/0 (84.72)	5/16	20.40 (.805)	27.10 (1.067)			19193-0360	54.70 (2.154)			
	3/8	20.40 (.805)	27.10 (1.067)			19193-0358	54.70 (2.154)			
	7/16	20.40 (.805)	27.10 (1.067)							
	1/2	20.40 (.805)	27.10 (1.067)	19071-0315	76.90 (3.029)	19193-0354	54.70 (2.154)			
	5/8	20.40 (.805)	27.10 (1.067)	19071-0319	76.90 (3.029)	19193-0362	54.70 (2.154)	19067-0120	76.40 (3.008)	
3/4	32.40 (1.274)	32.00 (1.260)	19071-0352	91.30 (3.594)						
4/0 (107.76)	5/16	21.10 (.830)	28.80 (1.135)			19193-0569	52.30 (2.215)	19067-0369	78.30 (3.08)	
	3/8	21.10 (.830)	28.80 (1.135)			19193-0375	52.30 (2.215)	19067-0124	78.30 (3.08)	
	7/16	21.10 (.830)	28.80 (1.135)			19193-0379	52.30 (2.215)	19067-0125	78.30 (3.08)	
	1/2	21.10 (.830)	28.80 (1.135)			19193-0372	52.30 (2.215)	19067-0123	78.30 (3.08)	
	5/8	21.10 (.830)	28.80 (1.135)			19193-0377	52.30 (2.215)	19067-0131	78.30 (3.08)	

Krimptite™ Ring Tongue (offset)

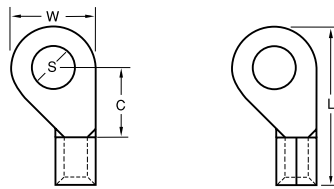

Physical
Material: Copper

Wire Range AWG (mm ²)	Stud Size (S)	Order No.	Dimension			Lead-free
			Minimum Clearance (C)	Maximum Length (L)	Maximum Width (W)	
12-14 (3.09-1.94)	10	19069-0380	9.4 (.370)	20.4 (.804)	10.8 (.425)	Yes

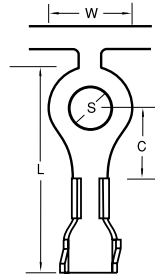

Metal Strip Open Barrel Rings with Vibration Support

Wire Range AWG (mm ²)	Stud Size (S)	Order No.	Diameter			Lead-free
			Minimum Clearance (C)	Maximum Width (W)	Maximum Length (L)	
14-18 (1.94-0.96) Brass	6	19085-0001	6.99 (.275)	9.98 (.385)	24.1 (.949)	Yes
	8	19085-0002				
	10	19085-0003				
14-18 (1.94-0.96) Tin-Plated Brass	6	19085-0004				
	8	19085-0005				
	10	19085-0006				
14-18 (1.94-0.96) Tin-Plated Steel	6	19085-0007				
	8	19085-0008				
	10	19085-0009				

Note: 14-18 part will accept 12 gauge wire

Star Ring Terminals

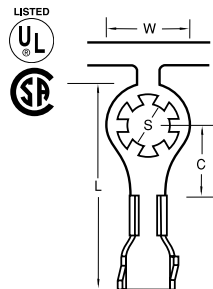

Metal Strip Open Barrel Star Rings with Vibration Support

Wire Range AWG (mm ²)	Stud Size (S)	Order No.	Dimension			Lead-free
			Minimum Clearance (C)	Maximum Width (W)	Maximum Length (L)	
14-18 (1.94-0.96) Brass	6	19084-0001	6.99 (.275)	9.98 (.385)	.949	Yes
	8	19084-0002				
	10	19084-0003				
14-18 (1.94-0.96) Tin-Plated Brass	6	19084-0004				
	8	19084-0005				
	10	19084-0006				
14-18 (1.94-0.96) Tin-Plated Steel	6	19084-0007				
	8	19084-0008				
	10	19084-0009				

Note: 14-18 part will accept 12 gauge wire

Star Ring Terminals



The Star Ring is a serrated ring that is mainly used for grounding. Unlike a ring terminal, when you tighten down on a star ring, the "star blades", or serrated edges, actually pierce through paint or other coatings, and bite into the metal to insure a good connection or ground. The product may also eliminate the need for lock washers.

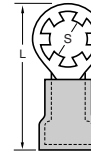
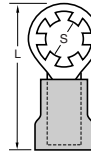
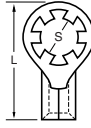
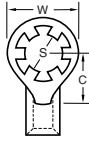

Wire Range AWG (mm ²)	Stud Size (S)	Dimension		Krimptite™			InsulKrimp™ – PVC Insulation			Avikrimp™ – Nylon Insulation			Lead-free
		Minimum Clearance (C)	Maximum Width (W)	Order No.		Maximum Length (L)	Order No.		Maximum Length (L)	Order No.		Maximum Length (L)	
				Loose Piece	Mylar Tape		Loose Piece	Mylar Tape		Loose Piece	Mylar Tape		
18-22 (0.96-0.38) Brass	6	6.99 (.275)	9.98 (.385)	19074-0001	19074-0002	17.8 (.70)	19075-0001	19075-0002	23.6 (.93)	19077-0001	19077-0002	23.6 (.93)	Yes
	8			19074-0004	19074-0006		19075-0003	19075-0004		19077-0005	19077-0006		
	10			19074-0007	19074-0008		19075-0005	19075-0006		19077-0007	19077-0008		
18-22 (0.96-0.38) Steel	6			19074-0009	19074-0010		19075-0007	19075-0008		19077-0009	19077-0010		
	8			19074-0011	19074-0012		19075-0009	19075-0010		19077-0011	19077-0012		
	10			19074-0013	19074-0014		19075-0011	19075-0012		19077-0013	19077-0014		
14-16 (1.94-1.23) Brass	6			19074-0015	19074-0016		19075-0013	19075-0014		19077-0015	19077-0016		
	8			19074-0017	19074-0018		19075-0015	19075-0016		19077-0017	19077-0018		
	10			19074-0019	19074-0020		19075-0017	19075-0018		19077-0019	19077-0020		
14-16 (1.94-1.23) Brass Steel	6			19074-0021	19074-0022		19075-0019	19075-0020		19077-0021	19077-0022		
	8			19074-0023	19074-0024		19075-0021	19075-0022		19077-0023	19077-0024		
	10			19074-0025	19074-0026		19075-0023	19075-0024		19077-0025	19077-0026		

Multi-Stud Rings

Features and Benefits

- One terminal mates with a range of stud sizes
- Consolidates inventory by reducing the number of part numbers required for purchase
- Available in loose piece and tape mounted format

Physical

Material: Copper

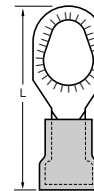
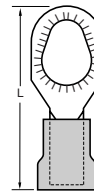
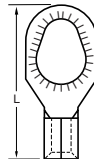
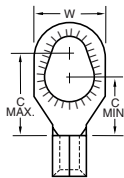

Wire Range AWG (mm ²)	Stud Size (S)	Dimension		Krimptite™			InsulKrimp™ – PVC Insulation			Avikrimp™ – Nylon Insulation			Lead-free
		Minimum Clearance (C)	Maximum Width (W)	Order No.		Maximum Length (L)	Order No.		Maximum Length (L)	Order No.		Maximum Length (L)	
				Loose Piece	Mylar Tape		Loose Piece	Mylar Tape		Loose Piece	Mylar Tape		
18-22 (0.96-0.38)	6 - 8 - 10	11.4 (.447)/ 8.4 (.330)	8.84 (.348)	19079-0004	19079-0005	22.0 (.866)	19080-0001	19080-0002	29.8 (1.172)	19081-0001	19081-0002	29.2 (1.148)	Yes
14-16 (1.94-1.23)	6 - 8 - 10		9.19 (.362)	19079-0007	19079-0009	22.0 (.866)	19080-0003	19080-0004	29.8 (1.172)	19081-0003	19081-0004	29.2 (1.148)	
10-12 (5.01-3.09)	6 - 8 - 10		10.4 (.410)	19079-0011	19079-0012	22.6 (.890)	19080-0005	19080-0006	30.3 (1.191)	19081-0005	19081-0006	32.9 (1.295)	

Spade Tongue Terminals



Physical
Material: Copper

A
Solderless Terminals

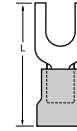
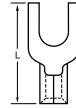
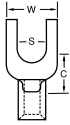

Wire Range AWG (mm ²)	Stud Size (S)	Minimum Clearance (C)	Maximum Width (W)	Krimptite™			InsulKrimp™ – PVC Insulation			Lead-free
				Order No.		Maximum Length (L)	Order No.		Maximum Length (L)	
				Loose Piece	Mylar Tape		Loose Piece	Mylar Tape		
18-22 (0.96-0.38)	5-6	7.70 (.303)	8.30 (.326)	19141-0020	19141-0021	17.50 (.690)	19144-0001	19144-0002	23.20 (.915)	Yes
	8	7.70 (.303)	8.30 (.326)	19141-0022	19141-0023	17.50 (.690)	19144-0003	19144-0004	23.20 (.915)	
	10	7.70 (.303)	8.30 (.326)	19141-0024	19141-0025	17.50 (.690)	19144-0005	19144-0006	23.20 (.915)	
14-16 (1.94-1.23)	3-4	5.30 (.209)	6.50 (.255)	19141-0050		14.40 (.565)	19144-0013	19144-0014	20.10 (.790)	
		5.30 (.209)	6.50 (.255)	19141-0052	19141-0053	14.40 (.565)	19144-0015	19144-0016	20.10 (.790)	
	5-6	5.40 (.211)	7.70 (.305)	19141-0056	19141-0057	14.30 (.564)	19144-0018	19144-0019	20.00 (.789)	
		5.40 (.211)	7.70 (.305)	19141-0058	19141-0059	14.30 (.564)	19144-0020	19144-0021	20.00 (.789)	
	8	6.80 (.269)	9.40 (.372)	19141-0063	19141-0064	17.40 (.687)	19144-0024	19144-0025	23.20 (.912)	
		6.80 (.269)	9.40 (.372)	19141-0065	19141-0066	17.40 (.687)	19144-0026	19144-0027	23.20 (.912)	
10-12 (5.01-3.09)	5-6	7.60 (.301)	9.80 (.385)	19141-0081	19141-0082	20.60 (.812)	19144-0037	19144-0038	28.00 (1.103)	
	8	7.60 (.301)	9.80 (.385)	19141-0083	19141-0084	20.60 (.812)	19144-0039	19144-0041	28.00 (1.103)	
	10	7.60 (.301)	9.80 (.385)	19141-0085	19141-0086	20.60 (.812)	19144-0042	19144-0043	28.00 (1.103)	

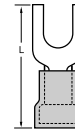

Wire Range AWG (mm ²)	Stud Size (S)	Minimum Clearance (C)	Maximum Width (W)	Avikrimp™ – Nylon Insulation				Lead-free	
				Order No.					Maximum Length (L)
				Loose Piece	Mylar Tape	Expanded Flare	Expanded Flare on Mylar Tape		
18-22 (0.96-0.38)	5-6	7.70 (.303)	8.30 (.326)	19198-0070	19198-0071			23.20 (.915)	Yes
	8	7.70 (.303)	8.30 (.326)	19198-0004	19198-0005			23.20 (.915)	
	10	7.70 (.303)	8.30 (.326)	19198-0006	19198-0007			23.20 (.915)	
14-16 (1.94-1.23)	5-6	5.30 (.209)	6.50 (.255)	19198-0012	19198-0013			20.50 (.805)	
		5.40 (.211)	7.70 (.305)	19198-0016	19198-0018			20.40 (.804)	
	8	5.40 (.211)	7.70 (.305)	19198-0019	19198-0020			20.40 (.804)	
		6.80 (.269)	9.40 (.372)	19198-0025	19198-0026			23.60 (.927)	
10-12 (5.01-3.09)	5-6	7.60 (.301)	9.80 (.385)	19198-0044	19198-0045		19198-0046	28.40 (1.118)	
	8	7.60 (.301)	9.80 (.385)	19198-0047	19198-0048		19198-0049	28.40 (1.118)	
	10	7.60 (.301)	9.80 (.385)	19198-0050	19198-0051		19198-0052	28.40 (1.118)	

Snap Spade Terminals



Physical
Material: Copper

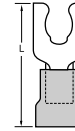
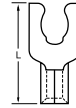
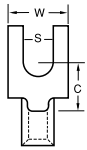

Wire Range AWG (mm ²)	Stud Size (S)	Minimum Clearance (C)	Maximum Width (W)	Krimptite™			InsulKrimp™ – PVC Insulation			Lead-free
				Order No.		Maximum Length (L)	Order No.		Maximum Length (L)	
				Loose Piece	Mylar Tape		Loose Piece	Mylar Tape		
18-22 (0.96-0.38)	5	5.80 (.230)	6.60 (.260)	19098-0017	19098-0077	14.80 (.585)	19099-0007	19099-0008	20.60 (.810)	Yes
	5-6	5.80 (.230)	6.60 (.260)	19098-0018	19098-0019	14.80 (.585)	19099-0009	19099-0010	20.60 (.810)	
	8	6.60 (.261)	8.10 (.320)	19098-0023	19098-0080	16.40 (.646)	19099-0013	19099-0014	22.10 (.871)	
	10	6.60 (.261)	8.60 (.340)	19098-0024	19098-0081	17.60 (.694)	19099-0015	19099-0016	23.30 (.919)	
14-16 (1.94-1.23)	5	5.80 (.230)	6.60 (.260)	19098-0041	19098-0042	14.80 (.585)	19099-0025	19099-0026	20.60 (.810)	
	5-6	5.80 (.230)	6.60 (.260)	19098-0043	19098-0044	14.80 (.585)	19099-0027	19099-0028	20.60 (.810)	
	8	6.60 (.261)	8.10 (.320)	19098-0047	19098-0048	16.40 (.646)	19099-0032	19099-0033	22.10 (.871)	
	10	6.60 (.261)	8.60 (.340)	19098-0049	19098-0050	17.60 (.694)	19099-0034	19099-0035	23.30 (.919)	
10-12 (5.01-3.09)	5-6	5.80 (.230)	6.60 (.260)	19098-0069	19098-0070	16.90 (.664)	19099-0044	19099-0045	24.30 (.995)	
	8	6.60 (.261)	8.10 (.320)	19098-0073	19098-0091	18.40 (.725)	19099-0048	19099-0049	25.70 (1.016)	
	10	6.60 (.261)	8.60 (.340)	19098-0074	19098-0075	19.60 (.773)	19099-0050	19099-0051	27.00 (1.064)	

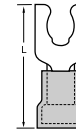

Wire Range AWG (mm ²)	Stud Size (S)	Minimum Clearance (C)	Maximum Width (W)	Avikrimp™ – Nylon Insulation			Lead-free
				Order No.		Maximum Length (L)	
				Loose Piece	Mylar Tape		
18-22 (0.96-0.38)	5	5.80 (.230)	6.60 (.260)	19115-0007	19115-0008	20.60 (.810)	Yes
	5-6	5.80 (.230)	6.60 (.260)	19115-0009	19115-0010	20.60 (.810)	
	8	6.60 (.261)	8.10 (.320)	19115-0012	19115-0013	22.10 (.871)	
	10	6.60 (.261)	8.60 (.340)	19115-0014	19115-0015	23.30 (.919)	
14-16 (1.94-1.23)	5	5.80 (.230)	6.60 (.260)	19115-0022	19115-0023	21.00 (.825)	
	5-6	5.80 (.230)	6.60 (.260)	19115-0024	19115-0025	21.00 (.825)	
	8	6.60 (.261)	8.10 (.320)	19115-0079	19115-0030	22.50 (.886)	
	10	6.60 (.261)	8.60 (.340)	19115-0031	19115-0032	23.70 (.934)	
10-12 (5.01-3.09)	5	5.80 (.230)	6.60 (.260)	19115-0041	19115-0057	24.60 (.970)	
	5-6	5.80 (.230)	6.60 (.260)	19115-0042	19115-0043	24.60 (.970)	
	8	6.60 (.261)	8.10 (.320)	19115-0046	19115-0047	26.20 (1.031)	
	10	6.60 (.261)	8.60 (.340)	19115-0048	19115-0049	27.40 (1.079)	

Block Spade Terminals



Physical
Material: Copper

A
Solderless Terminals

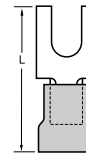
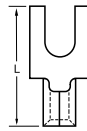
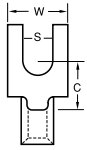

Wire Range AWG (mm ²)	Stud Size (S)	Minimum Clearance (C)	Maximum Width (W)	Krimptite™			InsulKrimp™ – PVC Insulation			Lead-free
				Order No.		Maximum Length (L)	Order No.		Maximum Length (L)	
				Loose Piece	Mylar Tape		Loose Piece	Mylar Tape		
18-22 (0.96-0.38)	1-2	4.60 (.183)	5.00 (.192)	19129-0055	19129-0054	12.80 (.502)	19131-0047	19131-0046	18.40 (.727)	Yes
	3-4	4.60 (.183)	5.00 (.192)	19129-0053	19129-0052	12.80 (.502)	19131-0045	19131-0044	18.40 (.727)	
		5.30 (.207)	6.50 (.255)	19129-0041	19129-0040	14.20 (.560)				
	5-6	5.30 (.207)	6.50 (.255)	19129-0039	19129-0038	14.20 (.560)	19131-0031	19131-0030	19.90 (.785)	
		7.70 (.305)	6.50 (.260)	19129-0051	19129-0050	17.00 (.670)	19131-0042	19131-0041	22.70 (.895)	
		5.30 (.207)	7.60 (.301)	19129-0047	19129-0046	14.20 (.560)	19131-0038	19131-0037	19.90 (.785)	
	8	5.30 (.207)	7.60 (.301)	19129-0045	19129-0044	14.20 (.560)	19131-0036	19131-0035	19.90 (.785)	
10	5.30 (.207)	7.60 (.301)	19129-0043	19129-0042	14.20 (.560)	19131-0034		19.90 (.785)		
14-16 (1.94-1.23)	3-4	5.30 (.209)	6.40 (.255)	19129-0032		14.20 (.560)	19131-0025	19131-0024	19.90 (.784)	
	5-6	5.30 (.209)	6.40 (.255)	19129-0030	19129-0028	14.20 (.560)	19131-0023	19131-0022	19.90 (.784)	
		5.40 (.211)	7.70 (.305)	19129-0024	19129-0069	14.20 (.560)	19131-0020	19131-0019	19.90 (.784)	
	8	5.40 (.211)	7.70 (.305)	19129-0022	19129-0021	14.10 (.556)	19131-0018	19131-0016	19.90 (.784)	
	10	5.40 (.211)	7.70 (.305)	19129-0020	19129-0019	14.10 (.556)	19131-0014	19131-0012	19.80 (.781)	
10-12 (5.01-3.09)	5-6	7.80 (.305)	8.40 (.330)	19129-0008	19141-0080	19.90 (.784)	19131-0006	19131-0005	27.30 (1.075)	
	8	7.80 (.305)	8.40 (.330)	19129-0007	19129-0006	19.90 (.784)	19131-0004	19131-0003	27.30 (1.075)	
	10	7.80 (.305)	8.40 (.330)	19129-0005		19.90 (.784)	19131-0002	19131-0059	27.30 (1.075)	

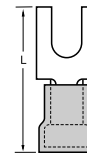

Wire Range AWG (mm ²)	Stud Size (S)	Minimum Clearance (C)	Maximum Width (W)	Avikrimp™ – Nylon Insulation			Lead-free
				Order No.		Maximum Length (L)	
				Loose Piece	Mylar Tape		
18-22 (0.96-0.38)	1-2	4.60 (.183)	5.00 (.192)	19139-0001	19139-0002	18.40 (.727)	Yes
	3-4	4.60 (.183)	5.00 (.192)	19139-0003	19139-0004	18.40 (.727)	
		5.30 (.207)	6.50 (.255)	19139-0016	19139-0017	19.90 (.785)	
	5-6	5.30 (.207)	6.50 (.255)	19139-0018	19139-0019	19.90 (.785)	
		7.70 (.305)	6.50 (.260)	19139-0006	19139-0007	22.70 (.895)	
		5.30 (.207)	7.60 (.301)	19139-0011	19139-0012	19.90 (.785)	
	8	5.30 (.207)	7.60 (.301)	19139-0013	19139-0014	19.90 (.785)	
10	5.30 (.207)	7.60 (.301)	19139-0015		19.90 (.785)		
14-16 (1.94-3.09)	3-4	5.30 (.209)	6.40 (.255)	19139-0038		20.30 (.799)	
	5-6	5.40 (.211)	7.70 (.305)	19139-0042	19139-0043	20.20 (.796)	
	8	5.40 (.211)	7.70 (.305)	19139-0044		20.20 (.796)	
	10	5.40 (.211)	7.70 (.305)	19139-0045	19193-0068	20.20 (.796)	
10-12 (5.01-3.09)	5-6	7.80 (.305)	8.40 (.330)	19198-0039	19198-0040	27.70 (1.090)	
	8	7.80 (.305)	8.40 (.330)	19139-0060	19198-0042	27.70 (1.090)	
	10	7.80 (.305)	8.40 (.330)	19139-0061	19198-0043	27.70 (1.090)	

Flanged Spade Terminals

Physical
Material: Brass or Steel

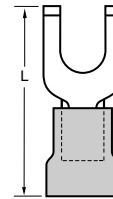
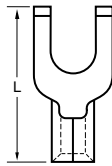
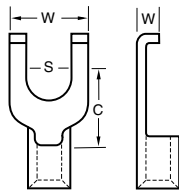

Wire Range AWG (mm ²)	Stud Size (S)	Minimum Clearance (C)	Maximum Width (W)	Krimptite™			InsulKrimp™			Lead-free
				Order No.		Maximum Length (L)	Order No.		Maximum Length (L)	
				Loose Piece	Mylar Tape		Loose Piece	Mylar Tape		
18-22 (0.96-0.38)	6	5.3 (.207)	7.6 (.301)	19118-0021	19118-0022	14.1 (.556)	19121-0005	19121-0006	19.8 (.781)	Yes
	8	5.3 (.207)	7.6 (.301)	19118-0023	19118-0024	14.1 (.556)	19121-0007	19121-0008	19.8 (.781)	
	10	5.3 (.207)	7.6 (.301)	19118-0025	19118-0099	14.1 (.556)	19121-0009	19121-0010	19.8 (.781)	
14-16 (1.94-1.23)	6	5.3 (.209)	7.6 (.301)	19118-0054	19118-0055	14.4 (.570)	19121-0026	19121-0027	20.2 (.795)	
	8	5.3 (.209)	7.6 (.301)	19118-0056	19118-0057	14.4 (.570)	19121-0028	19121-0029	20.2 (.795)	
	10	5.3 (.209)	7.6 (.301)	19118-0058	19118-0059	14.4 (.570)	19121-0030	19121-0031	20.2 (.795)	
10-12 (5.01-3.09)	6	7.8 (.305)	8.4 (.330)				19121-0046	19121-0085	27.3 (1.075)	
		7.7 (.301)	9.8 (.385)	19118-0084	19118-0130	19.6 (.770)	19121-0051	19121-0052	27.0 (1.061)	
	8	7.8 (.305)	8.4 (.330)	19118-0080	19118-0081	19.9 (.784)	19121-0047	19121-0048	27.3 (1.075)	
		7.7 (.301)	9.8 (.385)	19118-0086	19118-0087	19.6 (.770)	19121-0053	19121-0054	1.061 (.270)	
	10	7.8 (.305)	8.4 (.330)	19118-0082	19118-0083	19.9 (.784)	19121-0049	19121-0050	27.3 (1.075)	
		7.7 (.301)	9.8 (.385)	19118-0088	19118-0090	19.6 (.770)	19121-0056	19121-0057	27.0 (1.061)	

Physical
Material: Copper

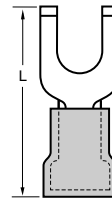
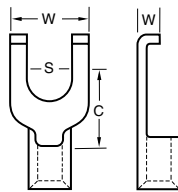

Wire Range AWG (mm ²)	Stud Size (S)	Minimum Clearance (C)	Maximum Width (W)	Avikrimp™			Lead-free
				Order No.		Maximum Length (L)	
				Loose Piece	Mylar Tape		
22-18 (0.96-0.38)	5-6	5.3 (.207)	7.6 (.301)	19127-0007	19127-0009	19.8 (.781)	Yes
	8	5.3 (.207)	7.6 (.301)	19127-0010	19127-0011	19.8 (.781)	
	10	5.3 (.207)	7.6 (.301)	19127-0012	19127-0013	19.8 (.781)	
14-16 (1.94-1.23)	5-6	5.3 (.209)	7.6 (.301)	19127-0039	19127-0041	20.6 (.810)	
	8	5.3 (.209)	7.6 (.301)	19127-0042	19127-0044	20.6 (.810)	
	10	5.3 (.209)	7.6 (.301)	19127-0099	19127-0045	20.6 (.810)	
10-12 (5.01-3.09)	8	7.7 (.301)	9.8 (.385)	19127-0086	19127-0087	27.3 (1.076)	
	10	7.7 (.301)	9.8 (.385)	19127-0089	19127-0090	27.3 (1.076)	

A

Solderless Terminals

Hook Tongue Terminals



Physical
Material: Copper

A

Solderless Terminals

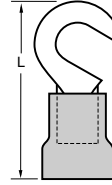
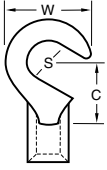

Wire Range AWG (mm ²)	Stud Size (S)	Minimum Clearance (C)	Maximum Width (W)	Krimptite™			InsulKrimp™			Lead-free
				Order No.		Maximum Length (L)	Order No.		Maximum Length (L)	
				Loose Piece	Mylar Tape		Loose Piece	Mylar Tape		
14-16 (1.94-1.23)	5-6	6.9 (.271)	9.1 (.360)	19178-0008	19178-0009	16.8 (.660)	19179-0008	19179-0009	22.5 (.885)	Yes
	8			19178-0010	19178-0011		19179-0010	19179-0011		
	10			19178-0012	19178-0013		19179-0012	19179-0013		
10-12 (5.01-3.09)	5-6	7.7 (.303)	9.7 (.382)				19179-0014	19179-0015	27.3 (1.074)	
	10			19178-0018	19178-0019	19.9 (.783)	19179-0019	19179-0020		

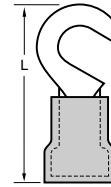

Wire Range AWG (mm ²)	Stud Size (S)	Minimum Clearance (C)	Maximum Width (W)	Avikrimp™				Lead-free
				Order No.			Maximum Length (L)	
				Loose Piece	Mylar Tape	Expanded Flare on Mylar Tape		
14-16 (1.94-1.23)	8	6.9 (.271)	9.1 (.360)	19183-0009	19183-0010		22.9 (.900)	Yes
	10	6.9 (.271)	9.1 (.360)	19183-0011	19183-0012		22.9 (.900)	
10-12 (5.01-3.09)	10	7.7 (.303)	9.7 (.382)	19183-0019	19183-0020	19183-0021	27.7 (1.089)	

Copper Lugs 250 MCM to 8 Wire Range Heavy Duty for 600V Applications



Features and Benefits

- Crimps in industry standard tooling
- Seamless barrel design
- Can be easily soldered or crimped
- Flared barrel entry for easy wire insertion
- AWG wire size identification on barrel
- Made of CDA-110 Copper stock offering 100% conductivity

Physical

Material: Copper
Plating: Tin

A

Solderless Terminals

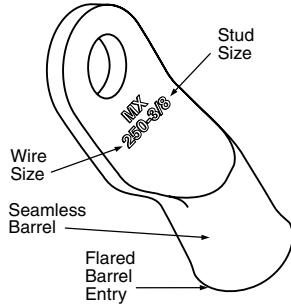

Wire Range AWG (mm ²)	Stud Size	Order No.		Dimension		Wire Entry Inside Diameter (ID)	Lead-free
		Plated	Unplated	Length	Width		
8 (7.96)	10	19221-0223	19221-0408	1.19 (30.15)	11.13 (0.438)	4.70 (0.185)	Yes
	1/4	19221-0224	19221-0409	1.19 (30.15)	11.13 (0.438)	4.70 (0.185)	
	5/16	19221-0225	19221-0411	1.19 (30.15)	11.13 (0.438)	4.70 (0.185)	
	5/16 Wide	19221-0483	19221-0482	1.31 (33.35)	15.09 (0.594)	4.70 (0.185)	
	3/8 Wide	19221-0226	19221-0410	1.31 (33.35)	15.09 (0.594)	4.70 (0.185)	
	3/8 Xwide	19221-0484	19221-0481	1.47 (37.31)	9.46 (0.766)	4.70 (0.185)	
6 (13.48)	1/2	19221-0414	19221-0415	1.47 (37.31)	9.46 (0.766)	4.70 (0.185)	
	10	19221-0424	19221-0425	1.28 (32.54)	11.13 (0.438)	5.89 (0.232)	
	1/4	19221-0495	19221-0494	1.28 (32.54)	11.13 (0.438)	5.89 (0.232)	
	1/4 Wide	19221-0227	19221-0406	1.41 (35.72)	15.09 (0.594)	5.89 (0.232)	
	5/16	19221-0492	19221-0493	1.28 (32.54)	11.13 (0.438)	5.89 (0.232)	
	5/16 Wide	19221-0228	19221-0407	1.41 (35.72)	15.09 (0.594)	5.89 (0.232)	
4 (21.28)	3/8 Wide	19221-0229	19221-0384	1.41 (35.72)	15.09 (0.594)	5.89 (0.232)	
	1/2	19221-0416	19221-0417	1.56 (39.71)	19.46 (0.766)	5.89 (0.232)	
	10	19221-0452	19221-0451	1.50 (38.10)	13.49 (0.531)	7.26 (0.286)	
	1/4	19221-0230	19221-0404	1.50 (38.10)	13.49 (0.531)	7.26 (0.286)	
	5/16	19221-0231	19221-0405	1.50 (38.10)	13.49 (0.531)	7.26 (0.286)	
	5/16 Wide	19221-0460	19221-0461	1.53 (38.89)	15.88 (0.628)	7.26 (0.286)	
2 (33.70)	3/8	19221-0232	19221-0383	1.50 (38.10)	13.49 (0.531)	7.26 (0.286)	
	3/8 Wide	19221-0456	19221-0458	1.53 (38.89)	15.88 (0.628)	7.26 (0.286)	
	1/2 Xwide	19221-0454	19221-0453	1.69 (42.88)	19.46 (0.766)	7.26 (0.286)	
	1/4	19221-0418	19221-0419	1.62 (41.28)	15.88 (0.625)	8.53 (0.336)	
	5/16	19221-0233	19221-0400	1.62 (41.28)	15.88 (0.625)	8.53 (0.336)	
	3/8	19221-0235	19221-0380	1.62 (41.28)	15.88 (0.625)	8.53 (0.336)	
1	1/2 Wide	19221-0236	19221-0399	1.75 (44.45)	19.05 (0.750)	8.53 (0.336)	
	1/4	19221-0420	19221-0421	1.72 (43.64)	16.66 (0.656)	9.14 (0.360)	
	5/16	19221-0237	19221-0396	1.72 (43.64)	16.66 (0.656)	9.14 (0.360)	
	3/8	19221-0238	19221-0378	1.72 (43.64)	16.66 (0.656)	9.14 (0.360)	
1/0 (52.95)	1/2 Wide	19221-0239	19221-0395	1.84 (46.48)	19.05 (0.750)	9.14 (0.360)	
	1/4	19221-0422	19221-0423	1.84 (46.48)	18.24 (0.718)	10.16 (0.400)	
	5/16	19221-0240	19221-0394	1.84 (46.48)	18.24 (0.718)	10.16 (0.400)	
	3/8	19221-0241	19221-0377	1.84 (46.48)	18.24 (0.718)	10.16 (0.400)	
2/0 (67.39)	1/2	19221-0242	19221-0393	1.84 (46.48)	18.24 (0.718)	10.16 (0.400)	
	1/4	19221-0234	19221-0249	2.06 (52.37)	20.65 (0.813)	11.71 (0.461)	
	5/16	19221-0243	19221-0398	2.06 (52.37)	20.65 (0.813)	11.71 (0.461)	
	3/8	19221-0244	19221-0379	2.06 (52.37)	20.65 (0.813)	11.71 (0.461)	
3/0 (84.72)	1/2	19221-0245	19221-0397	2.06 (52.37)	20.65 (0.813)	11.71 (0.461)	
	5/16	19221-0246	19221-0402	2.16 (54.76)	23.01 (0.906)	12.98 (0.511)	
	3/8	19221-0247	19221-0381	2.16 (54.76)	23.01 (0.906)	12.98 (0.511)	
	1/2	19221-0248	19221-0401	2.16 (54.76)	23.01 (0.906)	12.98 (0.511)	
4/0 (107.76)	5/16	19221-0412	19221-0413	2.34 (59.54)	24.99 (0.984)	14.20 (0.559)	
	3/8	19221-0250	19221-0382	2.34 (59.54)	24.99 (0.984)	14.20 (0.559)	
	1/2	19221-0251	19221-0403	2.34 (59.54)	24.99 (0.984)	14.20 (0.559)	
	5/16 Weld	19221-0503	19221-0502	2.69 (68.28)	27.78 (1.094)	15.88 (0.625)	
	3/8 Weld	19221-0371	19221-0374	2.69 (68.28)	27.78 (1.094)	15.88 (0.625)	
250 MCM	3/8	19221-0372	19221-0375	2.69 (68.28)	27.78 (1.094)	15.88 (0.625)	
		19221-0447	19221-0446	2.66 (67.46)	30.56 (1.203)	17.40 (0.685)	

Snap Plugs

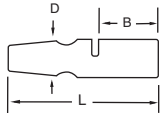

Features and Benefits

- Quality one-piece design
- Most economical style and has the greatest variety of uses where special features are not required
- Designed to SAE specifications
- Can be connected and disconnected repeatedly

Physical

Material: Copper Alloy
Plating: Tin

Krimptite™

Wire Range AWG (mm ²)	Loose Piece Order No.	Dimension			Lead-free
		Barrel Length (B)	Diameter (D)	Max. Length (L)	
18-22 (0.96-0.38)	19033-0001	6.45 (.254)	4.57 (.180)	19.2 (.754)	Yes
	19033-0003	6.45 (.254)	3.96 (.156)	17.6 (.694)	
14-16 (1.94-1.23)	19033-0005	6.45 (.254)	4.57 (.180)	19.2 (.754)	
	19033-0007	6.45 (.254)	3.96 (.156)	17.6 (.694)	

Note: For open barrel strip products, please contact Molex.

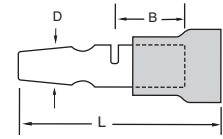

Features and Benefits

- Funnel entrance into the electrical barrel eliminates wire strand fold back and increases crimping rates
- Features a PVC sleeve to protect against vibration damage by preventing wire flex at the crimp point
- Designed to SAE specifications
- Can be connected and disconnected repeatedly

Physical

Material: Terminal—Copper Alloy
Insulation—PVC
Plating: Terminal—Tin

InsulKrimp™

Wire Range AWG (mm ²)	Loose Piece Order No.	Dimension			Max. Wire Insul. Dia.	Lead-free
		Barrel Length (B)	Diameter (D)	Max. Length (L)		
18-22 (0.96-0.38)	19034-0002	6.45 (.254)	4.57 (.180)	24.10 (.950)	3.60 (.140)	Yes
	19034-0005	6.45 (.254)	3.96 (.156)	22.60 (.890)	3.60 (.140)	
14-16 (1.94-1.23)	19034-0007	6.45 (.254)	4.57 (.180)	24.10 (.950)	4.40 (.175)	
	19034-0009	6.45 (.254)	3.96 (.156)	22.60 (.890)	4.40 (.175)	

Note: For open barrel strip products, please contact Molex.

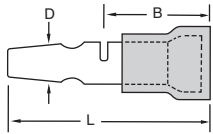

Features and Benefits

- Avikrimp provides a metal conductor sleeve for superior strain relief
- Fulfills the double crimp (support) requirements of VDE and others DIN Specifications
- Designed to SAE specifications
- Can be connected and disconnected repeatedly

Physical

Material: Terminal—Copper Alloy
Ferrule—Brass
Insulation—Nylon
Plating: Terminal—Tin
Ferrule—Tin

Avikrimp™

Molded Nylon Insulation

Wire Range AWG (mm ²)	Order No.		Dimension			Max. Wire Insulation Dia.	Lead-free
	Loose Piece	Mylar Tape	Barrel Length (B)	Diameter (D)	Max. Length (L)		
18-22 (0.96-0.38)	19035-0001	19035-0002	6.45 (.254)	4.57 (.180)	24.10 (.948)	3.60 (.140)	Yes
	19035-0003	19035-0004	6.45 (.254)	3.96 (.156)	22.60 (.888)	3.60 (.140)	
14-16 (1.94-1.23)	19035-0005	19035-0008	6.45 (.254)	4.57 (.180)	24.10 (.948)	4.30 (.170)	
	19035-0009	19035-0012	6.45 (.254)	3.96 (.156)	22.60 (.888)	4.30 (.170)	

Note: For open barrel strip products, please contact Molex.

Avikrimp™

Extruded Nylon Insulation

Wire Range AWG (mm ²)	Order No.		Dimension			Max. Wire Insulation Dia.	Lead-free
	Loose Piece	Mylar Tape	Barrel Length (B)	Diameter (D)	Max. Length (L)		
18-22 (0.96-0.38)	19036-0001	19036-0002	6.45 (.254)	4.57 (.180)	24.30 (.957)	3.60 (.140)	Yes
	19036-0003	19036-0005	6.45 (.254)	3.96 (.156)	22.80 (.897)	3.60 (.140)	
14-16 (1.94-1.23)	19036-0006	19036-0007	6.45 (.254)	4.57 (.180)	24.30 (.957)	4.30 (.140)	
	19036-0008	19036-0009	6.45 (.254)	3.96 (.156)	22.80 (.897)	4.30 (.140)	

Note: For open barrel strip products, please contact Molex.

Snap Receptacles

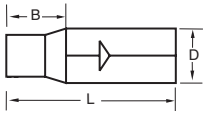

Features and Benefits

- Quality one-piece design
- Most economical style and has the greatest variety of uses where special features are not required

Physical

Material: Brass
Plating: Tin

Krimptite™

Wire Range AWG (mm ²)	Loose Piece Order No.	Dimension			Lead-free
		Barrel Length (B)	Snap Plug Diameter (D)	Maximum Length (L)	
18-22 (0.96-0.38)	19037-0002	5.10 (.200)	3.90 (.156)	16.20 (.640)	Yes
14-16 (1.94-1.23)	19037-0004	5.10 (.200)		16.20 (.640)	
18-22	19037-0015	5.10 (.200)	4.60 (.180)	17.80 (.700)	
14-16	19037-0006	5.10 (.200)		17.80 (.700)	

Note: For open barrel strip products, please contact Molex.

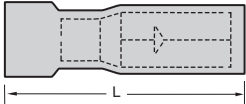

Features and Benefits

- Funnel entrance into the electrical barrel eliminates wire strand fold back and increases crimping rates
- Features a PVC sleeve to protect against vibration damage by preventing wire flex at the crimp point

Physical

Material: Brass
Plating: Tin

InsulKrimp™

Insulated with Funnel Entry

Wire Range AWG (mm ²)	Insulated with Funnel Entry					Maximum Wire Insulation Dia.	Lead-free
	Order No.		Dimension				
	PVC Insulation	Nylon Insulation	Barrel Length (B)	Snap Plug Diameter (D)	Maximum Length (L)		
18-22 (0.96-0.38)	19038-0037		10.60 (.420)	3.90 (.156)	25.60 (1.010)	Yes	
14-16 (1.94-1.23)	19038-0007	19038-0009	10.60 (.420)		25.60 (1.010)		
18-22 (0.96-0.38)	19038-0004	19038-0006	10.60 (.420)	4.60 (.180)	25.60 (1.010)		
14-16 (1.94-1.23)	19038-0011	19038-0013	10.60 (.420)		25.60 (1.010)		4.30 (.170)

Note: For open barrel strip products, please contact Molex.

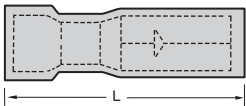

Features and Benefits

- Avikrimp provides a metal conductor support sleeve for superior strain relief
- Fulfills the double crimp (support) requirements of VDE and other DIN specifications

Physical

Material: Brass
Plating: Tin

Avikrimp™

Insulated with Vibration Support

Wire Range AWG (mm ²)	Insulated with Vibration Support						Maximum Wire Insulation Dia.	Lead-free
	Order No.			Dimension				
	PVC Insulation	Nylon Insulation	Nylon Insulation on Tape	Barrel Length (B)	Snap Plug Diameter (D)	Maximum Length (L)		
18-22 (0.96-0.38)	19039-0001	19039-0002	19039-0015	10.60 (.420)	3.90 (.156)	25.60 (1.010)	Yes	
14-16 (1.94-1.23)	19039-0006	19039-0007	19039-0016	10.60 (.420)		25.60 (1.010)		
18-22 (0.96-0.38)	19039-0004	19039-0005	19039-0017	10.60 (.420)	4.60 (.180)	25.60 (1.010)		
14-16 (1.94-1.23)	19039-0009	19039-0010	19039-0018	10.60 (.420)		25.60 (1.010)		3.80 (.150)

Note: For open barrel strip products, please contact Molex.

Vital Relay Terminals

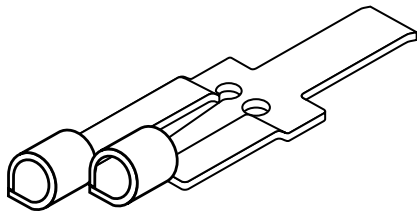

Features and Benefits

- Made from Phosphor Bronze material to provide durability and maximum conductivity.
- Brazed seams add strength to each barrel to prevent opening under conditions of stress or wire pull.
- Silver plated to provide corrosion resistance, solderability, and excellent conductivity.
- Manufactured to Exceed AAR Specifications.
- High quality Relay Terminals to fit GRS/Safetran Relay Bases

Physical

Material: Phosphor Bronze
Plating: Silver

Wire Range	Order No.	Maximum Length	Maximum Terminal Width	Maximum Contact Width	Barrel Inside Diameter	Maximum Locking Tab Width	Lead-free
16-20 AWG	19702-4101	41.28 (1.625)	11.68 (.460)	5.84 (.230)	3.30 (.130)	4.32 (.170)	Yes
10-14 AWG	19702-4001	42.42 (1.670)					

Mil Spec Approved Product

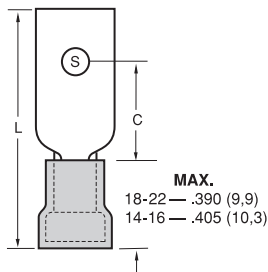

Molex solderless terminals and splices have long contributed to our nation's defense as high-quality components in a wide variety of weapons systems and defense equipment.

MIL-T-7928 is the specification most commonly used by the various government agencies, military prime and ordinance contractors and many original-equipment-manufacturers (OEM) as well as the aircraft and aerospace industries. This specification encompasses and governs several Mil Spec standards: MS/AS-20659, Uninsulated Ring Terminals; MS/AS-25036, Insulated Ring Terminals; and MS/AS-17143, Insulated Rectangular Terminals. The following quick-reference charts indicate the Molex Mil Spec terminals and splices that are manufactured to meet the above specifications.

QUALIFIED PRODUCTS LIST (QPL) APPROVALS

Class 1 approved terminals and splices conform to all dimensional requirements and meet all performance standards of the Mil Spec when crimped with QPL-approved crimping tools.

Class 2 approved terminals and splices meet all performance standards of the Mil Specs when crimped with the manufacturer's QPL-recognized crimping tools.

Types I and II further classify Mil Spec terminals and splices as noninsulated and insulated. Type I indicates "uninsulated" while Type II refers to "insulated" terminals and splices. Contact your Molex customer service representative for additional information and military cross-references.

Features and Benefits

- Rectangular tongue insulated terminals are covered by MS/AS-17143 (ships).

MS/AS-17143 Type II Insulated

Mil-Spec Dash No.	Order No.	Class	Lead-free	Mil-Spec Dash No.	Order No.	Class	Lead-free
-1	19095-0022	1 and 2	Yes	-11	19095-0076	1 and 2	Yes
-2	19095-0133			-13	19095-0030		
-4	19095-0024			-14	19095-0136		
-5	19095-0134			-16	19095-0032		
-7	19095-0026			-17	19095-0137		
-8	19095-0074			-19	19095-0034		
-10	19095-0028			-20	19095-0139		

Mil Spec Ring Tongue Terminals

A

Solderless Terminals

MS/AS-20659 Type I Noninsulated

MS/AS-20659 Dash No.	Order No.	Class	Lead-free
-101	19072-0010	2	Yes
-102	19072-0016		
-103	19072-0069		
-104	19072-0073		
-105	19193-0109	1 and 2	
-106	19193-0120		
-107	19193-0202		
-108	19193-0171		
-109	19193-0248		
-110	19193-0216		
-111	19193-0275		
-112	19193-0264		
-113	19193-0305		
-114	19193-0307		
-117	19193-0330		
-118	19193-0331		
-119	19193-0346		
-120	19193-0345		
-121	19193-0358		

MS/AS-20659 Dash No.	Order No.	Class	Lead-free
-122	19193-0354	2	Yes
-123	19193-0375		
-124	19193-0372		
-125			
-126	19072-0057		
-127	19072-0048		
-128	19193-0137	1 and 2	
-129	19193-0167		
-130	19193-0245		
-131	19193-0219		
-132	19193-0267		
-133	19193-0296		
-135	19193-0325		
-136	19193-0341		
-137			
-138	19072-0008		
-139	19072-0055		
-140	19193-0200		
-141	19193-0152		

MS/AS-20659 Dash No.	Order No.	Class	Lead-free
-142	19193-0179	2	Yes
-143	19193-0226		
-144	19193-0273		
-145	19193-0281		
-146	19193-0303		
-147	19193-0309		
-148	19193-0302		
-151	19193-0333		
-152	19193-0329		
-153	19193-0342		
-154	19193-0348		
-155	19193-0360		
-159			
-161			
-163	19072-0051		
-165	19193-0128		
-166	19193-0094		

MS/AS-25036 Type II Insulated

MS/AS-25036 Dash No.	Order No.	Class	Lead-free
-101	19073-0009	1 and 2	Yes
-102	19073-0038		
-103	19073-0017		
-104	19073-0027		
-105	19073-0032		
-106	19073-0067		
-107	19073-0083		
-108	19073-0087		
-109	19073-0079		
-110	19073-0059		
-111	19073-0160		
-112	19073-0170		
-113	19073-0200		
-114	19073-0236		
-115	19067-0006		
-116	19067-0008		
-117	19067-0025		

MS/AS-25036 Dash No.	Order No.	Class	Lead-free
-118	19067-0022	2	Yes
-119	19067-0069		
-120	19067-0071		
-121	19067-0055		
-122	19067-0052		
-123	19067-0082		
-124	19067-0079		
-125	19067-0078		
-126	19067-0096		
-127	19067-0097		
-128	19067-0090		
-132	19067-0103		
-133	19067-0359		
-134	19067-0315		
-135	19067-0112		
-136	19067-0111		
-138	19067-0118		

MS/AS-25036 Dash No.	Order No.	Class	Lead-free
-139	19067-0117	2	Yes
-141			
-143	19073-0253		
-144	19073-0248		
-148	19073-0007		
-149	19073-0013		
-150	19073-0024		
-152	19073-0065		
-153	19073-0085		
-154	19073-0076		
-156	19073-0165		
-157	19073-0188		
-159	19073-0005		

Wire Pin Terminals

Wire Pin Terminals offer quick and easy connections in applications where set screws or clamps are used to make electrical contact with the wire. Wire Pins simplify the insertion of stranded wire into European style terminal blocks and other components, by preventing wire strand foldback, assuring a proper electrical contact and a stronger connection than just wire alone.

Features and Benefits

- Fits all popular pin-type (European) terminal blocks
- Available in wire sizes 10 to 22 AWG noninsulated, PVC insulated and nylon insulated
- Provides a reliable, vibration-proof connection
- Allows for quick wire connects and disconnects from components
- Can be used/clamped repeatedly without damaging the wire
- Made of pure electrolytic Copper
- Electro Tin plated per Mil-T-10727
- Conveniently allows for multiple wires to be inserted into 1 terminal block contact

Physical

Material: Copper
Plating: Tin



Krimptite™

Wire Range AWG (mm ²)	Order No.		Insulation Color	Max. Insul. Dia. (in.)	Dimension			Lead-free
	Loose Piece	Mylar Tape			Overall Length (in.)	Pin Length (in.)	Pin Dia. (in.)	
18-22 (0.96-0.38)	19211-0003	19211-0004	N/A	N/A	17.0 (.670)	9.40 (.370)	2.03 (.080)	
14-16 (1.94-1.23)	19211-0005	19211-0006						
10-12 (5.01-3.09)	19211-0001	19211-0002						



Physical

Material: Terminal—Copper
Insulation—PVC
Plating: Tin

InsulKrimp™

Wire Range AWG (mm ²)	Order No.		Insulation Color	Max. Insul. Dia. (in.)	Dimension			Lead-free
	Loose Piece	Mylar Tape			Overall Length (in.)	Pin Length (in.)	Pin Dia. (in.)	
18-22 (0.96-0.38)	19212-0003	19212-0004	Red	3.68 (.145)	22.6 (0.890)	9.40 (.370)	2.03 (.080)	
14-16 (1.94-1.23)	19212-0005	19212-0006	Blue	4.45 (.175)				
10-12 (5.01-3.09)	19212-0001	19212-0002	Yellow	6.35 (.250)				29.0 (1.140)



Physical

Material: Terminal—Copper
Ferrule—Brass
Insulation—Nylon
Plating: Terminal—Tin
Ferrule—Tin

Avikrimp™

Wire Range AWG (mm ²)	Order No.		Insulation Color	Max. Insul. Dia. (in.)	Dimension			Lead-free
	Loose Piece	Mylar Tape			Overall Length (in.)	Pin Length (in.)	Pin Dia. (in.)	
18-22 (0.96-0.38)	19213-0009	19213-0010	Red	3.56 (.140)	21.8 (0.860)	9.40 (.370)	2.03 (.080)	
14-16 (1.94-1.23)	19213-0011	19213-0012	Blue	4.32 (.170)	23.6 (0.930)	9.40 (.370)	2.03 (.080)	
10-12 (5.01-3.09)	19213-0007	19213-0008	Yellow	5.72 (.225)	28.7 (1.130)	11.7 (.460)	3.05 (.120)	



Features and Benefits

- For aluminum and copper magnet wire
- Insulation piercing
- Open barrel design allows for easy placement of square bar stock into barrel
- Accommodates round, rectangular and square magnet wire
- Tin plated to delay corrosion
- Penetrates all types of insulation, varnish, etc.

Reference Information

Packaging: Box
UL File No. E32244
Designed In: inches

Electrical

Voltage: 2000V AC
Current: Contact Molex (wire size dependent)

Mechanical

Wire Pullout: Contact Molex (wire size dependent)

Physical

Material: Copper Alloy
Plating: Tin
Operating Temperature: -40°C to + 110°C

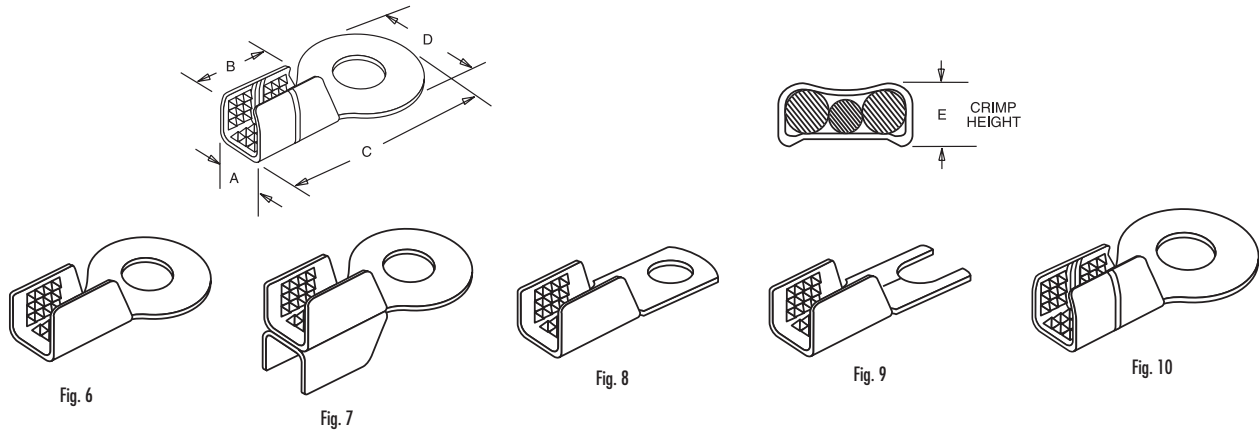

Order No.	Figure	Stud Size	Dimensions					Circular Mil Area	Round Wire Range, AWG (mm ²)	Rectangular Wire Range		Lead-free
			A	B	C	D	E*			Thickness	Width	
19195-1022	8	8	9.65 (.38)	14.2 (.56)	31.0 (1.22)	10.4 (0.41)	4.3 (0.17)	4,110-20,760	10-14(a) (5.01-1.94)	2.0-2.3 (.08-.09)	2.0-4.6 (.08-.18)	Yes
19195-1006		10			31.0 (1.22)							
19195-1012		1/4			35.8 (1.41)							
19195-1115	9	10	9.65 (.38)	14.2 (.56)	31.0 (1.22)	10.4 (0.41)	4.3 (0.17)	4,110-20,760	10-14(a) (5.01-1.94)	2.0-2.3 (.08-.09)	2.0-4.6 (.08-.18)	
19195-1019	8	10	13.5 (.53)	15.5 (.61)	40.1 (1.58)	12.7 (0.50)	6.35 (0.25)	10,380-52,480	2(c)-12(b) (33.70-3.09)	2.5-4.1 (.10-.16)	2.5-6.6 (.10-.26)	
19195-1011		1/4										
19195-1007	6	1/4	13.5 (.53)	15.5 (.61)	40.1 (1.58)	20.6 (0.81)	6.35 (0.25)	10,380-52,480	2(c)-12(b) (33.70-3.09)	2.5-4.1 (.10-.16)	2.5-6.6 (.10-.26)	
19195-1035		5/16										
19195-1021		3/8										
19195-1037		1/2										
19195-1085	7	1/4	13.5 (.53)	15.5 (.61)	40.1 (1.58)	20.6 (0.81)	12.7 (0.50)	20,760-104,960(e)	2(c)-12(b) (33.70-3.09)	2.5-4.1 (.10-.16)	2.5-6.6 (.10-.26)	
19195-1056		3/8										
19195-1034	10	3/8	22.4 (.88)	38.1 (1.50)	70.1 (2.76)	26.9 (1.06)	(d)	50,000-115,000		2.54-4.45 (.100-.175)	7.62-15.88 (.300-.625)	
19195-1040		1/2										
19195-1031		3/8										
19195-1047		1/2										

Note: Wire sizes and combinations shown have been tested to and meet or exceed Molex specification. Connectors may be suitable for other wire sizes or combinations but should be tested for specific applications.

* Not recommended for aluminum magnet wire finer than 21 gauge.
* Dimension for reference only. See crimp die illustration for gauging.

- (a) 4 wires maximum.
- (b) 6 wires maximum.
- (c) 3 wires maximum each barrel.
- (d) 6 wires maximum each barrel.
- (e) Crimping dies may not bottom. Connector height will depend on number and size of wires in barr Pump must deliver 9800 psi minimum.

Splices

MagKrimp™	B-2
Temp-Terms (High-Temperature Splices)	B-3
Parallel Splices	B-4
Butt Splices	B-5 to B-7
3 and 4 Way Connectors	B-7
IDC Multi-Lock/Ultimate Wire Tap	B-8

Features and Benefits

- For aluminum and copper magnet wire
- Insulation piercing
- Open barrel design allows for easy placement of square bar stock into barrel
- Accommodates round, rectangular and square magnet wire
- Tin plated to delay corrosion
- Penetrates all types of insulation, varnish

Reference Information

Packaging: Box
UL File No. E32244
Designed In: Inches

Electrical

Voltage: 2000V AC
Current: Contact Molex (wire size dependent)

Mechanical

Wire Pullout: Contact Molex (wire size dependent)

Physical

Material: Copper Alloy
Plating: Tin
Operating Temperature: -40°C to + 110°C

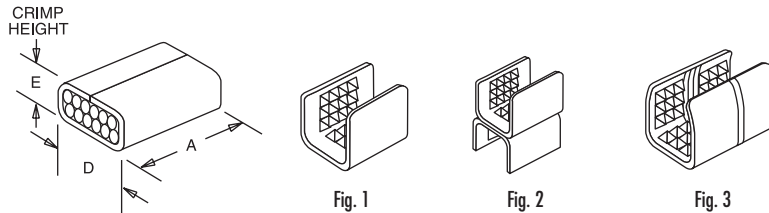

Order No.	Fig	Dimensions			Circular Mil Area	Round Wire Range, AWG (mm ²)	Rectangular Wire Range		Lead-free
		Length (A)	Width (D)	Crimp Height (D*)			Thickness	Width	
19195-1002	1	16.0 (.63)	9.7 (.38)	43.2 (1.70)	4,110-20,760	10-14(a) (5.01-1.94)	2.0-2.3 (.08-.09)	2.0-4.6 (.08-.18)	Yes
19195-1004	1	17.5 (.69)	13.5 (.53)	6.35 (.25)	10,380-52,480	2-12(b) (33.70-3.09)	2.5-4.1 (.10-.16)	2.5-6.6 (.10-.26)	
19195-1027	2	17.5 (.69)	13.5 (.53)	12.7 (.50)	20,760-104,960(e)	2-12(c) (33.70-3.09)	2.5-4.1 (.10-.16)	2.5-6.6 (.10-.26)	
19195-1023	3	38.1 (1.50)	22.4 (.88)	(d)	50,000-115,000		2.54-4.45 (.100-.175)	7.62-15.9 (.300-.625)	
19195-1041	3	38.1 (1.50)	22.4 (.88)	(d)	110,000-175,000		4.45-6.35 (.175-.250)	7.62-15.9 (.300-.625)	
19195-1044	3	44.5 (1.75)	22.4 (.88)	(d)	165,000-230,000		4.45-8.26 (.175-.325)	7.62-15.9 (.300-.625)	

Note: Wire sizes and combinations shown have been tested to and meet or exceed Molex specifications. Connectors may be suitable for other wire sizes or combinations but should be tested for specific applications.

* Not recommended for aluminum magnet wire finer than 21 gauge.

* Dimension for reference only. See crimp die illustration for gauging.

(a) 4 wires maximum.

(b) 6 wires maximum.

(c) 6 wires maximum each barrel.

(d) Crimping dies may not bottom. Connector height will depend on number and size of wires in barrel. Pump must deliver 9800 psi minimum.

(e) CMA is total for both sides.

Parallel Splices



343°C (650°F) VersaKrimp™

Wire Range	Order No.	Minimum Inside Diameter	Maximum Outside Diameter	Maximum Length (L)	Stock Thickness	Lead-free
18-22 (0.96-0.38)	19203-0165	1.5 (.060)	3.3 (.130)	8.4 (.330)	0.8 (.032)	Yes
14-16 (1.94-1.23)	19203-0172	2.3 (.091)	4.1 (.160)			
10-12 (5.01-3.09)	19203-0169	3.3 (.130)	5.7 (.225)			

Butt Splices

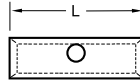

343°C (650°F) VersaKrimp™

Wire Range	Order No.	Minimum Inside Diameter	Maximum Outside Diameter	Maximum Length (L)	Stock Thickness	Lead-free
18-22 (0.96-0.38)	19203-0166	1.50 (0.59)	3.30 (.130)	17.1 (.675)	0.8 (.032)	Yes
14-16 (1.94-1.23)	19203-0171	2.31 (0.91)	4.06 (.160)			
10-12 (5.01-3.09)	19203-0183	3.50 (.138)	5.92 (.233)			

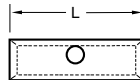

483°C (900°F) Krimptite™

Wire Range	Order No.	Minimum Inside Diameter	Maximum Outside Diameter	Maximum Length (L)	Stock Thickness	Lead-free
18-22 (0.96-0.38)	19203-0384	1.27 (.05)	3.56 (.140)	14.7 (.580)	0.8 (.032)	Yes
14-16 (1.94-1.23)	19203-0385	1.78 (.07)	4.32 (.17)			
10-12 (5.01-3.09)	19203-0386	3.05 (.12)	5.84 (.23)	14.9 (.585)	1.0 (.040)	

Parallel Splices

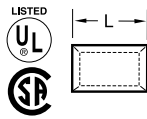

Physical
Material: Copper
Plating: Tin

Krimptite™

Wire Range AWG (mm ²)	Order No.	Minimum Inside Diameter (ID)	Maximum Outside Diameter (OD)	Maximum Length (L)	Lead-free
14-16 (1.94-1.23)	19208-0001	2.10 (.084)	4.20 (.165)	8.60 (.340)	Yes
10-12 (5.01-3.09)	19208-0002	3.30 (.128)	5.80 (.230)	8.40 (.330)	

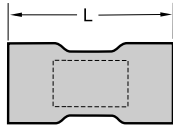

Physical
Material: Splice—Copper
Insulation—PVC
Plating: Tin

InsulKrimp™

Wire Range AWG (mm ²)	Order No.	Maximum Length (L)	Lead-free
18-22 (0.96-0.38)	19206-0002*	18.10 (.712)	Yes
14-16 (1.94-1.23)	19206-0004	18.70 (.735)	
	19206-0005*	18.70 (.735)	
10-12 (5.01-3.09)	19206-0008	12.10 (.831)	
	19206-0010*	12.10 (.831)	



Physical
Material: Copper
Plating: Tin

VersaKrimp™

Wire Range AWG (mm ²)	Order No.	Minimum Inside Diameter (ID)	Maximum Outside Diameter (OD)	Maximum Length (L)	Lead-free
18-22 (0.96-0.38)	19207-0001*	1.50 (.060)	3.30 (.130)	8.40 (.332)	Yes
14-16 (1.94-1.23)	19205-0001*	2.30 (.091)	4.10 (.160)	8.40 (.330)	
10-12 (5.01-3.09)	19205-0003*	3.30 (.130)	5.70 (.225)	8.40 (.330)	
8 (7.96)	19205-0004	4.20 (.165)	7.50 (.295)	10.40 (.408)	
6 (13.48)	19205-0006	5.80 (.230)	9.50 (.374)	12.10 (.477)	
4 (21.28)	19205-0007	7.00 (.277)	11.60 (.457)	13.90 (.547)	
2 (33.70)	19205-0008	9.00 (.357)	13.70 (.538)	17.20 (.680)	
1/0 (52.95)	19205-0009	11.20 (.439)	15.70 (.620)	20.10 (.790)	
2/0 (67.39)	19205-0010	12.60 (.496)	17.70 (.697)	19.80 (.779)	
3/0 (84.72)	19215-0049	13.80 (.545)	19.30 (.760)	20.30 (.800)	
4/0 (107.76)	19215-0050	15.80 (.621)	21.80 (.860)	20.80 (.820)	

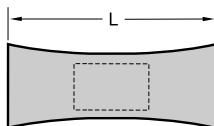

Physical
Material: Splice—Copper
Insulation—Nylon
Plating: Tin

NylaKrimp™ – Nylon Insulation

Wire Range AWG (mm ²)	Order No.	Maximum Length (L)	Lead-free
18-22 (0.96-0.38)	19207-0002*	17.00 (.670)	Yes
14-16 (1.94-1.23)	19207-0004*	16.40 (.645)	
10-12 (5.01-3.09)	19207-0005*	17.50 (.688)	

*Part has seamless barrel instead of butted seam

Step Down Butt Splices



Features and Benefits

- The Step Down Butt Splice is the perfect solution when 2 wires need to be inserted in one end of a splice and a single wire in the other end

Physical

Material: Splice—Copper
Insulation—PVC
Plating: Tin

NON-INSULATED

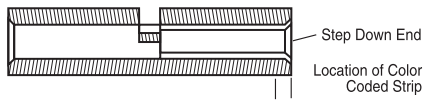

INSULATED

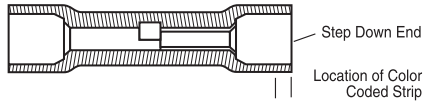

Wire Size AWG (mm ²)	CMA Range	Order No.		Insulation Color	Lead-free
		Loose Piece	Mylar Tape		
14-16 to 18-22 (1.94-1.23 to 0.96-0.38)	2050-5180 to 509-2600	19215-0013	19215-0017	Noninsulated	Yes
10-12 to 14-16 (5.01-3.09 to 1.94-1.23)	5180-13100 to 2050-5180	19215-0023	19215-0027		
8 to 10-12 (7.96 to 5.01-3.09)	13100-20800 to 5180-13100	19215-0037			
6 to 8 (13.48 to 7.96)	20800-33100 to 13100-20800	19215-0042			
14-16 to 18-22 (1.94-1.23 to 0.96-0.38)	2050-5180 to 509-2600	19154-0022	19154-0057	Blue with red stripe	
10-12 to 14-16 (5.01-3.09 to 1.94-1.23)	5180-13100 to 2050-5180	19154-0035	19154-0036	Yellow with blue stripe	
8 to 10-12 (7.96 to 5.01-3.09)	13100-20800 to 5180-13100	19154-0044		Red with yellow stripe	
6 to 8 (13.48 to 7.96)	20800-33100 to 13100-20800	19154-0047		Blue with red stripe	

Window Butt Splices

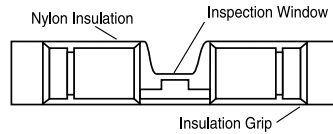

Physical

Material: Splice—Copper
Ferrule—Brass
Insulation—Nylon
Plating: Splice—Tin
Ferrule—Tin

Wire Size AWG (mm ²)	Mil Spec	Order No.		Maximum Length (L)	Maximum Wire Insulation Diameter	Insulation Color	Lead-free
		Loose Piece	Mylar Tape				
18-22 (0.96-0.38)	M7928/5-3	19199-0007	19199-0008	32.0 (1.260)	3.56 (.140)	Red	Yes
14-16 (1.94-1.23)	M7928/5-4	19199-0009	19199-0010	32.0 (1.260)	4.32 (.170)	Blue	
10-12 (5.01-3.09)	M7928/5-5	19199-0011	19199-0012	41.1 (1.620)	5.79 (.228)	Yellow	

Funnel Entry Nylon Butt Splices

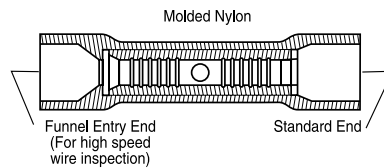

Physical

Material: Splice—Copper
Insulation—Nylon
Plating: Tin

Wire Range AWG (mm ²)	Order No.		Maximum Length (in.) (L)	Maximum Wire Insulation Diameter (in.)		Seam Type	Lead-free
	Loose Piece	Mylar Tape		Funnel End	Standard End		
18-22 (0.96-0.38)	19202-0011	19202-0012	27.2 (1.070)	3.73 (.147)	4.09 (.161)	Seamless	Yes
14-16 (1.94-1.23)	19202-0027	19202-0029	27.2 (1.070)	4.70 (.185)	5.05 (.199)		
10-12 (5.01-3.09)	19202-0046	19202-0047	29.2 (1.150)	6.65 (.262)	7.01 (.276)		
18-22 (0.96-0.38)	19202-0063	19202-0007	27.2 (1.070)	3.73 (.147)	4.09 (.161)	Butted	
14-16 (1.94-1.23)	19202-0019	19202-0021	27.2 (1.070)	4.70 (.185)	5.05 (.199)		
10-12 (5.01-3.09)	19202-0039	19202-0041	29.2 (1.150)	6.65 (.262)	7.01 (.276)		

Seamless Barrel Butt Splices

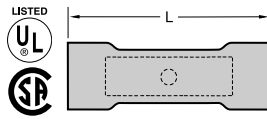

Physical
Material: Terminal—Copper
Insulation—PVC
Plating: Tin

Splices

InsulKrimp™

Wire Size AWG (mm ²)	Order No.		Maximum Length (L)	Maximum Wire Insulation Diameter	Lead-free
	Loose Piece	Mylar Tape			
8 (7.96)	19154-0041	19154-0042	38.40 (1.510)	9.80 (.385)	Yes
6 (13.48)	19154-0045		47.10 (1.855)	11.20 (.440)	
4 (21.28)	19154-0048		51.80 (2.036)	15.40 (.605)	
2 (33.70)	19154-0049		32.40 (1.277)	16.50 (.650)	

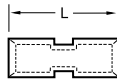

Physical
Material: Copper

VersaKrimp™

Wire Size AWG (mm ²)	Order No.		Minimum Inside Diameter	Maximum Outside Diameter	Maximum Length (L)	Lead-free
	Loose Piece	Mylar Tape				
8 (7.96)	19215-0034	19215-0035	4.20 (.165)	7.50 (.295)	21.90 (.864)	Yes
6 (13.48)	19215-0040		5.80 (.230)	9.50 (.374)	26.50 (1.045)	
4 (21.28)	19215-0045		7.00 (.277)	11.60 (.457)	29.30 (1.155)	
2 (33.70)	19215-0046		9.10 (.357)	13.70 (.538)	32.50 (1.280)	
1/0 (52.95)	19215-0047*		11.20 (.439)	15.70 (.620)	36.60 (1.440)	
2/0 (67.39)	19215-0048*		12.60 (.496)	17.70 (.697)	36.60 (1.440)	
3/0 (84.72)	19205-0012*		13.80 (.545)	19.30 (.760)	39.10 (1.540)	
4/0 (107.76)	19205-0013*		15.80 (.621)	21.80 (.860)	39.10 (1.540)	

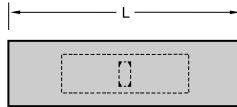

Physical
Material: Terminal—Copper
Insulation—Nylon
Plating: Tin

NylaKrimp™

Wire Size AWG (mm ²)	Loose Piece Order No.	Maximum Length (L)	Maximum Wire Insulation Diameter	Lead-free
8 (7.96)	19202-0054	36.60 (1.440)	6.70 (.265)	Yes
6 (13.48)	19202-0055	45.50 (1.790)	8.70 (.342)	
4 (21.28)	19202-0056	51.80 (2.040)	10.90 (.429)	

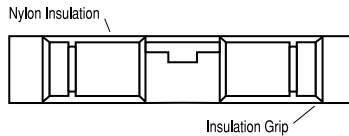

Physical
Material: Terminal—Copper
Ferrule—Brass
Insulation—Nylon
Plating: Terminal—Tin
Ferrule—Tin

Avikrimp™

Wire Range AWG (mm ²)	Order No.		Maximum Length (L)	Maximum Wire Insulation Diameter	Insulation Color	Lead-free
	Loose Piece	Mylar Tape				
18-22 (0.96-0.38)	19199-0013	19199-0002	32.0 (1.260)	3.60 (.140)	Red	Yes
14-16 (1.94-1.23)	19199-0003	19199-0004	32.0 (1.260)	4.30 (.170)	Blue	
10-12 (5.01-3.09)	19199-0005	19199-0006	41.2 (1.620)	5.80 (.228)	Yellow	

Butt Splices

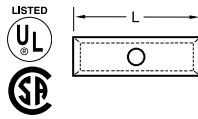

Physical
Material: Terminal—Copper
Plating: Tin

Krimptite™

Wire Range AWG	Order No.		Inside Diameter	Outside Diameter	Maximum Length (L)	Lead-free
	Loose Piece	Mylar Tape				
18-22 (0.96-0.38)	19189-0002	19189-0004	1.40 (.055)	3.34 (.131)	14.70 (.580)	Yes
14-16 (1.94-1.23)	19189-0008	19189-0010	1.98 (.078)	5.71 (.225)	14.70 (.580)	
10-12 (5.01-3.09)	19189-0015	19189-0017	3.15 (.124)	4.14 (.163)	14.90 (.585)	

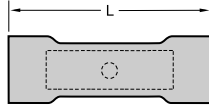

Physical
Material: Terminal—Copper
Insulation—PVC
Plating: Tin

InsulKrimp™

Wire Range AWG (mm ²)	Order No.		Maximum Length (L)	Maximum Wire Insulation Diameter	Lead-free
	Loose Piece	Mylar Tape			
18-22 (0.96-0.38)	19154-0004	19154-0006	24.40 (.960)	4.10 (.160)	Yes
	19154-0011*	19154-0012*	26.30 (1.035)	3.70 (.145)	
14-16 (1.94-1.23)	19154-0015	19154-0017	25.90 (1.020)	4.60 (.180)	
	19154-0023*	19154-0024*	27.40 (1.080)	4.30 (.170)	
10-12 (5.01-3.09)	19154-0028	19154-0030	28.80 (1.135)	6.70 (.265)	
	19154-0037*	19154-0038*	33.10 (1.305)	6.60 (.260)	

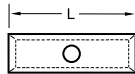

Physical
Material: Copper
Plating: Tin

VersaKrimp™

Wire Range AWG (mm ²)	Order No.		Inside Diameter	Outside Diameter	Maximum Length (L)	Lead-free
	Loose Piece	Mylar Tape				
18-22 (0.96-0.38)	19215-0009*	19215-0011*	1.50 (.059)	3.30 (.130)	17.10 (.675)	Yes
14-16 (1.94-1.23)	19215-0018*	19215-0115*	2.30 (.091)	4.10 (.160)	17.10 (.675)	
10-12 (5.01-3.09)	19215-0028*	19215-0030*	3.50 (.138)	5.70 (.223)	21.00 (.827)	

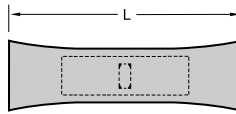

Physical
Material: Terminal—Copper
Insulation—Nylon
Plating: Tin

NylaKrimp™

Wire Range AWG (mm ²)	Order No.		Maximum Length (L)	Maximum Wire Insulation Diameter	Lead-free
	Loose Piece	Mylar Tape			
18-22 (0.96-0.38)	19202-0013*	19202-0016*	26.30 (1.035)	3.30 (.130)	Yes
14-16 (1.94-1.23)	19202-0031*	19202-0035*	27.40 (1.080)	3.60 (.140)	
10-12 (5.01-3.09)	19202-0049*	19202-0051*	33.00 (1.300)	5.70 (.223)	

*Part has seamless barrel instead of butted seam.

3 and 4 Way Connectors

Physical
Material: Copper

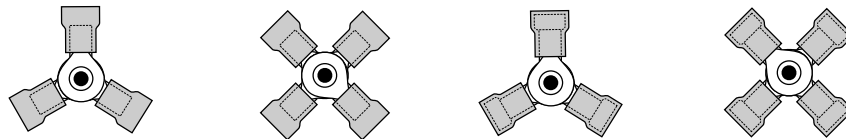

Wire Range AWG (mm ²)	InsulKrimp™ – PVC Insulation	InsulKrimp™ – PVC Insulation	Avikrimp™ – Nylon Insulation	Avikrimp™ – Nylon Insulation	Lead-free
	Order No.				
18-22 (0.96-0.38)	19204-0004	19204-0003	19204-0009	19204-0008	Yes
14-16 (1.94-1.23)	19204-0014	19204-0013	19204-0018	19204-0017	
10-12 (5.01-3.09)	19204-0026	19204-0025	19204-0030	19204-0029	

Insulation Displacement Connectors (IDC) Multi-Lock

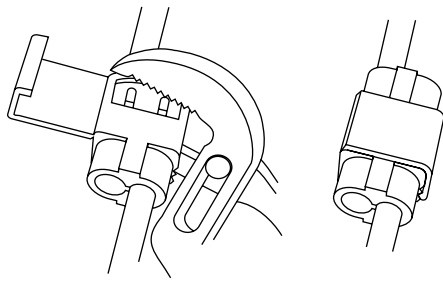

The quick, convenient Multi-Lock connectors have many uses. Using only ordinary channel-lock pliers, these color-coded connectors make quick, reliable, pre-insulated splices without stripping, twisting, soldering or the need for special tools.

They will tap-splice, pigtail-splice, parallel splice or in-line splice insulated Copper wire conductors for a wide range of applications.

Physical

Material: Barb—Brass
 Housing—Polypropylene
 Plating: Tin

Applications:

- Automotive
 - Lights
 - Gauges
 - Speakers
 - Horn
- Non-Automotive transportation
 - Marine
 - Truck and bus
 - RV
 - ATVs
- Home and Office
 - Shop equipment
 - Burglar alarms
 - Security systems

Self-tapping (IDC) Tap-And-Run Connectors

Wire Range AWG (mm ²)	Order No.	Possible Layouts					Lead-free
18-22 (0.96-0.38)	19216-0005						Yes
14-18 (1.94-1.23)	19216-0004						
	19216-0003						
10-12 (5.01-3.09)	19216-0002						

Ultimate Wire Tap

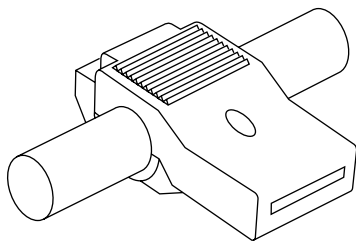

The Wire Tap makes tapping into an existing wire quick, easy and reliable. This Tap-And-Run splice is actually a fully insulated female quick disconnect that can be spliced onto a wire and then mated with a fully insulated* male quick disconnect, all without stripping, twisting, soldering or the need for special tools. The dual barb insulation piercing design ensures reliable contact.

Physical

Material: Terminal—Copper Alloy
 Housing—Nylon
 Plating: Tin

Wire Range AWG (mm ²)	Order No.	Insulation Color	Lead-free
18-22 (0.96-0.38)	19216-0011	Red	Yes
14-16 (1.94-1.23)	19216-0010	Blue	
12 (3.09)	19216-0009	Yellow	

* Also mates with partially or noninsulated quick disconnects

Quick Disconnects

Fully Insulated Quick Disconnects	C-2 to C-4
Piggyback Terminals/Tab Adapters	C-5 to C-6
Uninsulated Flag Terminals/Temp-Terms Quick Disconnects	C-7
Tape-Fed and Loose Piece Quick Disconnects	C-8 to C-11
Metal Strip Quick Disconnects	C-11 to C-13
PCB Tabs	C-14 to C-15

InsulKrimp™ Fully Insulated Quick Disconnects



Features and Benefits

- Designed for dense packaging requirements; the profile height is lower than other competing products on the market
- Integrity of mechanical/electrical performance is assured for wire secureness, operating temperatures, tensile strength, dielectric parameters and insertion/extraction forces by meeting UL 310 standards (Listed under UL File No. E79133)
- Color-coded translucent insulator allows easy identification of terminal size and wire gauge:

- Red—18 to 22 AWG
- Blue—14 to 16 AWG
- Yellow—24 to 26 AWG and 10 to 12 AWG

- Translucent “see-through” insulator provides fast, on-line quality control inspection by allowing a quick visual check of the wire/terminal assembly
- Funnel entrance is designed for increased crimping rates by speeding wire delivery into the crimp section and eliminating wire strand fold back
- A wire stop stamped into the crimp barrel prevents insertion of over-stripped wires

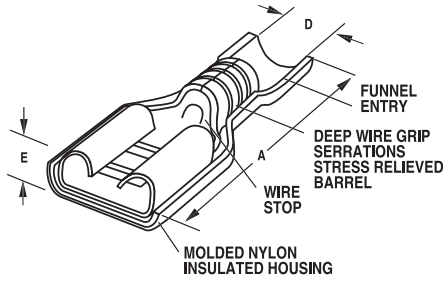

Female—Standard Flare

Wire Range AWG (mm ²)	Accepts Tab Size	Order No.			Color	Stock	Dimension			Lead-free
		Loose Piece	Mylar Tape	Molded Strip			Length (A)	Maximum Wire Insulation Diameter (D)	Height (E)	
24-26 (0.22-0.13)	6.35 by 0.81 (.250 by .032)	19003-0071	19003-0073	19003-0106	Yellow	0.81 (.032)	21.8 (.860)	1.91 (.075)	4.57 (.180)	Yes
	4.75 by 0.81 (.187 by .032)	19003-0068	19003-0070	19003-0104			19.8 (.780)	1.91 (.075)	4.06 (.160)	
	4.75 by 0.51 (.187 by .020)	19003-0064	19003-0067	19003-0103			19.8 (.780)	1.91 (.075)	4.06 (.160)	
18-22 (0.96-0.38)	6.35 by 0.81 (.250 by .032)	19003-0001	19003-0003	19003-0105	Red	0.41 (.016)	21.8 (.860)	3.43 (.135)	4.57 (.180)	
	4.75 by 0.51 (.187 by .020)	19003-0011	19003-0013	19003-0107			19.8 (.780)	3.43 (.135)	4.06 (.160)	
	4.75 by 0.81 (.187 by .032)	19003-0017	19003-0020	19003-0108			19.8 (.780)	3.43 (.135)	4.06 (.160)	
	5.21 by 0.51 (.205 by .020)	19003-0036	19003-0074	19003-0109			19.8 (.780)	3.43 (.135)	4.06 (.160)	
	6.35 by 0.81 (.250 by .032)	19003-0038	19003-0075	19003-0110			19.8 (.780)	3.43 (.135)	4.06 (.160)	
	2.79 by 0.51 (.110 by .020)	19003-0024	19003-0026	19003-0097			19.8 (.780)	3.43 (.135)	3.81 (.150)	
	2.79 by 0.81 (.110 by .032)	19003-0030	19003-0032	19003-0098			19.8 (.780)	3.43 (.135)	3.81 (.150)	
14-16 (1.94-1.23)	6.35 by 0.81 (.250 by .032)	19003-0040	19003-0042	19003-0041	Blue	0.41 (.016)	21.8 (.860)	4.06 (.160)	4.57 (.180)	
	4.75 by 0.51 (.187 by .020)	19003-0050	19003-0052	19003-0051			19.8 (.780)	4.06 (.160)	4.32 (.170)	
	4.75 by 0.81 (.187 by .032)	19003-0056	19003-0058	19003-0057			19.8 (.780)	4.06 (.160)	4.32 (.170)	
	5.21 by 0.51 (.205 by .020)	19003-0062	19003-0077	19003-0085			19.8 (.780)	4.06 (.160)	4.32 (.170)	
10-12 (5.01-3.09)	6.35 by 0.81 (.250 by .032)	19606-0002	19606-0003	19606-0001	Yellow	0.81 (.032)	26.1 (1.030)	6.10 (.240)	5.59 (.220)	

Female—Expanded Flare

Wire Range AWG (mm ²)	Accepts Tab Size	Order No.			Color	Stock	Dimension			Lead-free
		Loose Piece	Mylar Tape	Molded Strip			Length (A)	Maximum Wire Insulation Diameter (D)	Height (E)	
18-22 (0.96-0.38)	6.35 by 0.81 (.250 by .032)	19003-0008	19003-0010	19003-0009	Red	0.41 (.016)	23.7 (.935)	5.84 (.230)	4.57 (.180)	Yes
	4.75 by 0.51 (.187 by .020)	19003-0014	19003-0016	19003-0015			21.8 (.860)	5.84 (.230)	4.06 (.160)	
	4.75 by 0.81 (.187 by .032)	19003-0021	19003-0023	19003-0022			21.8 (.860)	5.84 (.230)	4.06 (.160)	
	2.79 by 0.51 (.110 by .020)	19003-0027	19003-0029	19003-0028			21.8 (.860)	5.84 (.230)	3.81 (.150)	
	2.79 by 0.81 (.110 by .032)	19003-0033	19003-0035	19003-0034			21.8 (.860)	5.84 (.230)	3.81 (.150)	
14-16 (1.96-1.23)	6.35 by 0.81 (.250 by .032)	19003-0047	19003-0049	19003-0048	Blue	0.41 (.016)	23.7 (.935)	6.60 (.260)	4.57 (.180)	
	4.75 by 0.51 (.187 by .020)	19003-0053	19003-0055	19003-0054			21.8 (.860)	6.60 (.260)	4.32 (.170)	
	4.75 by 0.81 (.187 by .032)	19003-0059	19003-0061	19003-0060			21.8 (.860)	6.60 (.260)	4.32 (.170)	
10-12 (5.01-3.09)	6.35 by 0.81 (.250 by .032)	19005-0010	19005-0015	19005-0014	Yellow	0.46 (.018)	26.4 (1.040)	6.99 (.275)	7.37 (.290)	

Female, UL 94V-0 Nylon



Wire Range AWG (mm ²)	Accepts Tab Size	Order No.			Color	Stock	Dimension			Lead-free
		Loose Piece	Molded Strip	Mylar Tape			Length (A)	Maximum Wire Insulation Diameter (D)	Height (E)	
18-22 (0.96-0.38)	6.35 by 0.81 (.250 by .032)	19003-0005	19003-0111	19003-0007	Red	0.41 (.016)	21.8 (.860)	3.43 (.135)	4.57 (.180)	Yes
14-16 (1.96-1.23)	6.35 by 0.81 (.250 by .032)	19003-0044	19003-0045	19003-0080	Blue		21.8 (.860)	3.68 (.145)	4.57 (.180)	
10-12 (5.01-3.09)	6.35 by 0.81 (.250 by .032)	19005-0016	19005-0017	19003-0018	Yellow		26.4 (1.040)	6.99 (.275)	7.37 (.290)	
24-26 (0.22-0.13)	4.75 by 0.51 (.187 by .020)	19003-0138	19003-0140	19003-0139			19.8 (.780)	1.91 (.075)	4.06 (.160)	
	4.75 by 0.81 (.187 by .032)	19003-0141	19003-0143	19003-0142			19.8 (.780)	1.91 (.075)	4.06 (.160)	
18-22 (0.96-0.38)	4.75 by 0.51 (.187 by .020)	19003-0126	19003-0128	19003-0127	Red		19.8 (.780)	3.43 (.135)	4.06 (.160)	
	4.75 by 0.81 (.187 by .032)	19003-0129	19003-0131	19003-0130			19.8 (.780)	3.43 (.135)	4.06 (.160)	
14-16 (1.96-1.23)	4.75 by 0.51 (.187 by .020)	19003-0132	19003-0134	19003-0133	Blue		19.8 (.780)	4.06 (.160)	4.32 (.170)	
	4.75 by 0.81 (.187 by .032)	19003-0135	19003-0137	19003-0136			19.8 (.780)	4.06 (.160)	4.32 (.170)	

Avikrimp™ Fully Insulated Quick Disconnects

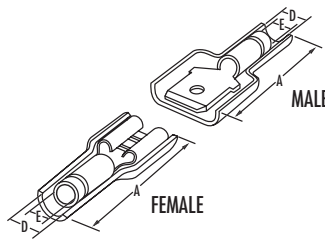

Features and Benefits

- Avikrimp provides a metal insulation support sleeve for superior strain relief
- Fulfills the double crimp (support) requirements of VDE and other DIN specifications

Male—Standard Flare

Wire Range AWG (mm ²)	Male Tab Size	Order No.		Color	Stock	Dimension			Lead-free
		Loose Piece	Mylar Tape			Length (A)	Maximum Wire Insulation Diameter (D)	Barrel Dia. (E)	
18-22 (0.96-0.38)	6.35 by 0.81 (.250 by .032)	19001-0001	19001-0002	Red	0.79 (.031)	24.4 (.960)	3.56 (.140)	1.42 (.056)	Yes
	4.75 by 0.51 (.187 by .020)	19001-0003	19001-0005			22.9 (.900)	3.56 (.140)	1.42 (.056)	
14-16 (1.94-1.23)	6.35 by 0.81 (.250 by .032)	19001-0006	19001-0007	Blue	0.79 (.031)	24.4 (.960)	4.32 (.170)	2.13 (.084)	
	4.75 by 0.51 (.187 by .020)	19001-0008	19001-0009			22.9 (.900)	4.32 (.170)	2.13 (.084)	
10-12 (5.01-3.09)	6.35 by 0.81 (.250 by .032)	19001-0010	19001-0011	Yellow	0.79 (.031)	27.4 (1.080)	5.84 (.230)	3.58 (.141)	

Female—Standard Flare

Wire Range AWG (mm ²)	Accepts Tab Size	Order No.			Color	Stock	Dimension			Lead-free
		Loose Piece	Mylar Tape	Metal Strip			Length (A)	Maximum Wire Insulation Diameter (D)	Barrel Dia. (E)	
18-22 (0.96-0.38)	6.35 by 0.81 (.250 by .032)	19002-0001	19002-0002	19002-0004	Red	0.41 (.016)	22.6 (.890)	3.05 (.120)	1.42 (.056)	Yes
	4.75 by 0.51 (.187 by .020)	19002-0005	19002-0007	19002-0008			20.3 (.800)	3.05 (.120)	1.42 (.056)	
	4.75 by 0.81 (.187 by .032)	19002-0009	19002-0010	19002-0012			20.3 (.800)	3.05 (.120)	1.42 (.056)	
	5.21 by 0.51 (.205 by .020)	19002-0019	19002-0020	19002-0059			20.3 (.800)	3.05 (.120)	1.42 (.056)	
	6.35 by 0.81 (.250 by .032)	19002-0021	19002-0022	19002-0023			20.3 (.800)	3.05 (.120)	1.42 (.056)	
	2.79 by 0.51 (.110 by .020)	19002-0013	19002-0014	19002-0015			20.3 (.800)	3.05 (.120)	1.42 (.056)	
14-16 (1.94-1.23)	2.79 by 0.81 (.110 by .032)	19002-0016	19002-0017	19002-0018	Blue	0.30 (.012)	20.3 (.800)	3.05 (.120)	1.42 (.056)	
	6.35 by 0.81 (.250 by .032)	19002-0024	19002-0025	19002-0027			22.6 (.890)	3.94 (.155)	2.08 (.082)	
	4.75 by 0.51 (.187 by .020)	19002-0028	19002-0029	19002-0030			20.3 (.800)	3.94 (.155)	2.08 (.082)	
	4.75 by 0.81 (.187 by .032)	19002-0031	19002-0032	19002-0033			20.3 (.800)	3.94 (.155)	2.08 (.082)	
	5.21 by 0.51 (.205 by .020)	19002-0040	19002-0048	19002-0041			20.3 (.800)	3.94 (.155)	2.08 (.082)	
	6.35 by 0.81 (.250 by .032)	19002-0042	19002-0043	19002-0061			20.3 (.800)	3.94 (.155)	2.08 (.082)	
	10-12 (5.01-3.09)	2.79 by 0.51 (.110 by .020)	19002-0034	19002-0035	19002-0036	Yellow	0.79 (.031)	20.3 (.800)	3.94 (.155)	2.08 (.082)
		2.79 by 0.81 (.110 by .032)	19002-0037	19002-0038	19002-0039			20.3 (.800)	3.94 (.155)	2.08 (.082)
		6.35 by 0.81 (.250 by .032)	19606-0005	19606-0006	19606-0004			25.7 (1.01)	5.84 (.230)	3.05 (.120)

Female—Expanded Flare/Oval Barrel

Wire Range AWG (mm ²)	Accepts Tab Size	Order No.			Color	Barrel	Stock	Dimension			Lead-free
		Loose Piece	Mylar Tape	Metal Strip				Length (A)	Maximum Wire Insulation Diameter (D)	Barrel Dia. (E)	
16 + 16 (1.23) 18 + 18 (0.96) 20 + 20 (0.62) 22 + 22 (0.38)	6.35 by 0.81 (.250 by .032)	*19600-1300	19600-1306	Yellow	Oval	0.79 (.031)	23.9 (.940)	6.86/4.32 (.27/.17)	2.90 (.114)	Yes	
	4.75 by 0.51 (.187 by .020)	*19600-1302	19600-1307				21.8 (.860)	6.86/4.32 (.27/.17)	2.90 (.114)		
	4.75 by 0.81 (.187 by .032)	*19600-1304	19600-1308				21.8 (.860)	6.86/4.32 (.27/.17)	2.90 (.114)		
10-12 (5.00-3.30)	6.35 by 0.81 (.250 by .032)	19002-0044	19002-0045	19002-0046	Expanded Flare	0.46 (.018)	26.4 (1.04)	6.22 (.245)	3.66 (.144)		

*Note: MWID is oval for dual wire insertion

Fully Insulated Quick Disconnects Couplers

Features and Benefits

- Available 18 to 22 AWG through 10 to 12 AWG
- Splice can be connected and disconnected without damage to the nylon
- Fully insulated nylon couplers are precision engineered to allow male and female terminal to fit precisely together for a fully insulated in-line splice.

Male

Wire Range AWG (mm ²)	Tab Size	Order No.		Color	Stock	Dimension			Lead-free
		Loose Piece	Mylar Tape			Length (A)	Maximum Wire Insulation Diameter (D)	Barrel Dia. (E)	
18-22 (0.96-0.38)	6.35 by 0.81 (.250 by .032)	19004-0001	19004-0004	Red	0.79 (.031)	24.6 (.970)	3.68 (.145)	1.42 (.056)	Yes
14-16 (1.94-1.23)		19004-0005	19004-0008	Blue		24.6 (.970)	4.32 (.170)	2.11 (.083)	
10-12 (5.01-3.09)		19004-0009	19004-0012	Yellow		28.4 (1.120)	6.48 (.255)	3.68 (.145)	

Female

Wire Range AWG (mm ²)	Accepts Tab Size	Order No.			Color	Stock	Dimension			Lead-free
		Loose Piece	Mylar Tape	Molded Strip			Length (A)	Maximum Wire Insulation Diameter (D)	Barrel Dia. (E)	
18-22 (0.96-0.38)	6.35 by 0.81 (.250 by .032)	19005-0001	19005-0004	19005-0003	Red	0.46 (.018)	22.61 (.890)	4.19 (.165)	2.11 (.083)	Yes
14-16 (1.94-1.23)		19005-0005	19005-0009	19005-0008	Blue		22.61 (.890)	4.19 (.165)	2.11 (.083)	
10-12 (5.01-3.09)		19005-0010	19005-0015	19005-0014	Yellow		26.416 (1.040)	6.99 (.275)	3.81 (.150)	

Quick Disconnects Fully Insulated Flag Terminals

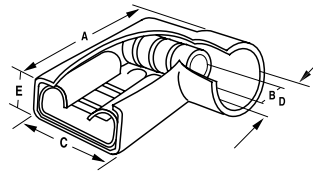
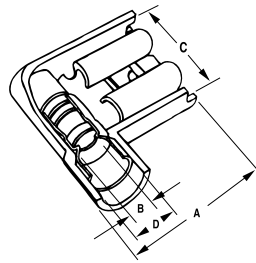

Physical
Material: Terminal—Brass
Insulation—Nylon
Plating: Tin

Features and Benefits

- Space saving design
- Available in insulated and uninsulated versions
- Because of the width, mylar mounted tape parts are double spaced



Wire Range AWG (mm ²)	Accepts Tab Size	Order No.			Color	Stock	Dimension				Lead-free
		Loose Piece	Mylar Tape	Metal Strip			Length (A)	Barrel Inside Diameter (B)	Width (C)	Maximum Wire Insulation Diameter (D)	
18-22 (0.96-0.38)	6.35 by 0.81 (.250 by .032)	19006-0001	19006-0003	19006-0004	Red	0.41 (.016)	15.75 (.620)	1.70 (.067)	9.91 (.390)	3.81 (.150)	Yes
14-16 (1.94-1.23)		19006-0011	19006-0013	19006-0014	Blue		15.75 (.620)	2.13 (.084)		4.32 (.170)	
10-12 (5.01-3.09)		19006-0019	19006-0020	19006-0070	Yellow		16.94 (.667)	3.25 (.128)		6.22 (.245)	
18-22 (0.96-0.38)	4.75 by 0.81 (.187 by .032)	19006-0008	19006-0009	19006-0010	Red		15.75 (.620)	1.70 (.067)		3.81 (.150)	
14-16 (1.94-1.23)		19006-0017	19006-0018	19006-0024	Blue		15.75 (.620)	2.13 (.084)		4.32 (.170)	
18-22 (0.96-0.38)		19006-0005	19006-0006	19006-0007	Red		15.75 (.620)	1.70 (.067)		3.81 (.150)	
14-16 (1.94-1.23)	4.75 by 0.51 (.187 by .020)	19006-0015	19006-0016	19006-0023	Blue		15.75 (.620)	2.13 (.084)		4.32 (.170)	

InsulKrimp™

Wire Range AWG (mm ²)	Accepts Tab Size	Order No.			Color	Stock	Dimension					Lead-free
		Loose Piece	Mylar Tape	Metal Strip			Length (A)	Barrel Inside Diameter (B)	Width (C)	Maximum Wire Insulation Diameter (D)	Height (E)	
18-22 (0.96-0.38)	6.35 by 0.81 (.250 by .032)	19007-0001	19007-0004	19007-0008	Red	0.41 (.016)	16.0 (.630)	1.70 (.067)	9.91 (.390)	4.45 (.175)	5.08 (.200)	Yes
14-16 (1.94-1.23)		19007-0021	19007-0024	19007-0028	Blue		16.0 (.630)	2.26 (.089)	9.91 (.390)	5.08 (.200)	5.08 (.200)	
10-12 (5.01-3.09)		19007-0040	19007-0053	19007-0041	Yellow		16.94 (.667)	3.23 (.127)	9.91 (.390)	6.65 (.262)	6.32 (.249)	
18-22 (0.96-0.38)	4.75 by 0.81 (.187 by .032)	19007-0015	19007-0016	19007-0020	Red		16.0 (.630)	1.70 (.067)	9.91 (.390)	4.45 (.175)	5.08 (.200)	
14-16 (1.94-1.23)		19007-0035	19007-0036	19007-0039	Blue		16.0 (.630)	2.26 (.089)	9.91 (.390)	5.08 (.200)	5.08 (.200)	
18-22 (0.96-0.38)		19007-0009	19007-0010	19007-0014	Red		16.0 (.630)	1.70 (.067)	9.91 (.390)	4.45 (.175)	5.08 (.200)	
14-16 (1.94-1.23)	4.75 by 0.51 (.187 by .020)	19007-0029	19007-0030	19007-0034	Blue		16.0 (.630)	2.26 (.089)	9.91 (.390)	5.08 (.200)	5.08 (.200)	

Expanded Flare

Wire Range AWG (mm ²)	Accepts Tab Size	Order No.			Color	Stock	Dimension				Lead-free
		Loose Piece	Mylar Tape	Metal Strip			Length (A)	Barrel Inside Diameter (B)	Width (C)	Maximum Wire Insulation Diameter (D)	
18-22 (0.96-0.38)	6.35 by 0.81 (.250 by .032)	19007-0005	19007-0006	19007-0007	Red	0.41 (.016)	16.8 (.660)	1.70 (.067)	9.91 (.390)	6.10 (.240)	Yes
14-16 (1.94-1.23)		19007-0025	19007-0026	19007-0027	Blue			2.26 (.089)		6.73 (.265)	
18-22 (0.96-0.38)		19007-0017	19007-0018	19007-0019	Red			1.70 (.067)		6.10 (.240)	
14-16 (1.94-1.23)	19007-0037	19007-0038	19007-0060	Blue	2.26 (.089)			6.73 (.265)			
18-22 (0.96-0.38)	4.75 by 0.51 (.187 by .020)	19007-0011	19007-0012	19007-0013	Red			1.70 (.067)		6.10 (.240)	
14-16 (1.94-1.23)		19007-0031	19007-0032	19007-0033	Blue			2.26 (.089)		6.73 (.265)	

Note: Expanded flare not illustrated.

Standard Flare with 94V-0 Nylon

Wire Range AWG (mm ²)	Accepts Tab Size	Order No.			Color	Stock	Dimension					Lead-free	
		Loose Piece	Mylar Tape	Metal Strip			Length (A)	Barrel Inside Diameter (B)	Width (C)	Maximum Wire Insulation Diameter (D)	Height (E)		
18-22 (0.96-0.38)	6.35 by 0.81 (.250 by .032)	19007-0064	19007-0065	19007-0066	Red	0.41 (.016)	16.00 (.630)	1.70 (.067)	9.91 (.390)	4.47 (.176)	5.00 (.197)	Yes	
	4.75 by 0.51 (.187 by .020)	19007-0067	19007-0068	19007-0069				1.70 (.067)		4.47 (.176)	4.98 (.196)		
	4.75 by 0.51 (.187 by .020)	19007-0070	19007-0071	19007-0072				1.70 (.067)		4.47 (.176)	4.98 (.196)		
14-16 (1.94-1.23)	6.35 by 0.81 (.250 by .032)	19007-0073	19007-0074	19007-0075	Blue			16.00 (.630)		2.26 (.089)	5.08 (.200)		5.00 (.197)
	4.75 by 0.51 (.187 by .020)	19007-0076	19007-0077	19007-0078				16.00 (.630)		2.26 (.089)	5.08 (.200)		4.98 (.196)
	4.75 by 0.51 (.187 by .020)	19007-0079	19007-0080	19007-0081				16.00 (.630)		2.26 (.089)	5.08 (.200)		4.98 (.196)
10-12 (5.01-3.09)	6.35 by 0.81 (.250 by .032)	19007-0082	19007-0083	19007-0084	Yellow			17.3 (.682)		3.23 (.127)	6.60 (.260)		

Fully Insulated Quick Disconnects Piggyback

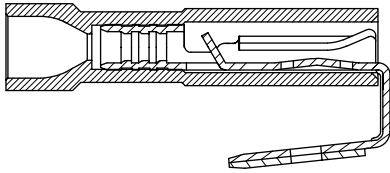

Features and Benefits

- Funnel entrance into electrical barrel eliminates wire strand fold back and increase crimping rates
- Nylon sleeve protects against vibration damage by preventing wire flex at the crimp point

Physical

Material: Terminal—Brass
Insulation—Nylon
Plating: Tin

InsulKrimp™ Standard Flare

Wire Range AWG (mm ²)	Tab Size	Order No.		Maximum Wire Insulation Diameter	Width	Length	Lead-free
		Loose Piece	Mylar Tape				
18-22 AWG (0.96-0.38)	6.35 by 0.81 (.250 by .032)	19013-0025	19013-0026	3.50 (.138)	9.65 (.380)	21.84 (.860)	Yes
14-16 AWG (1.94-1.23)		19013-0029	19013-0030	4.04 (.159)		21.84 (.860)	
10-12 AWG (5.01-3.09)		19013-0033	19013-0034	7.03 (.277)		26.16 (1.030)	

InsulKrimp™ Expanded Flare

Wire Range AWG (mm ²)	Tab Size	Order No.		Maximum Wire Insulation Diameter	Width	Length	Lead-free
		Loose Piece	Mylar Tape				
18-22 AWG (0.96-0.38)	6.35 by 0.81 (.250 by .032)	19013-0027	19013-0028	5.82 (.229)	9.65 (.380)	23.88 (0.94)	Yes
14-16 AWG (1.94-1.23)		19013-0031	19013-0032	6.58 (.259)		23.88 (0.94)	
10-12 AWG (5.01-3.09)		19013-0033	19013-0034	7.03 (.277)		1.030 (26.16)	

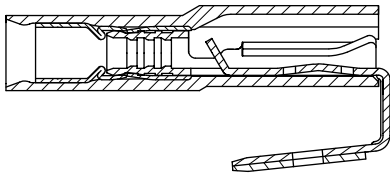

Features and Benefits

- Avikrimp provides a metal insulation support sleeve for superior strain relief
- Fulfills the double crimp (support) requirements of VDE and other DIN specifications

Physical

Material: Terminal—Brass
Ferrule—Brass
Insulation—Nylon
Plating: Terminal—Tin
Ferrule—Tin

Avikrimp™

Wire Range AWG (mm ²)	Tab Size	Order No.		Maximum Wire Insulation Diameter	Width	Length	Lead-free
		Loose Piece	Mylar Tape				
18-22 AWG (0.96-0.38)	6.35 by 0.81 (.250 by .032)	19602-0004	19602-0010	2.95 (.116)	9.65 (.380)	22.35 (0.88)	Yes
14-16 AWG (1.94-1.23)		19602-0005	19602-0011	3.53 (.139)		22.35 (0.88)	
10-12 AWG (5.01-3.09)		19602-0006	19602-0012	5.87 (.231)		25.91 (1.02)	

Quick Disconnects Piggyback

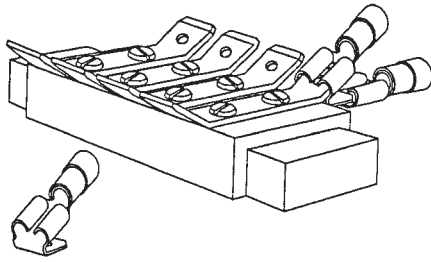

Features and Benefits

- Allows another quick disconnect to be connected to the tab
- Use when multiple connections are required and there is a limited number of male tabs
- Funnel entrance into electrical barrel eliminates wire strand fold back and increases crimping rates
- PVC sleeve protects against vibration damage by preventing wire flex at the crimp point

Physical

Material: Terminal—Brass
Insulation—PVC
Plating: Tin

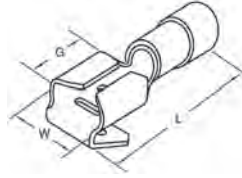

Quick Disconnects

InsulKrimp™

Wire Range AWG (mm ²)	Tab Size	Order No.		Maximum Wire Insulation Diameter	Dimension			Lead-free
		Loose Piece	Mylar Tape		Tab Length (G)	Overall Length (L)	Width (W)	
18-22 (0.96-0.38)	6.35 by 0.81 (.250 by .032)	19011-0035	19011-0036	2.79 (.110)	7.90 (.310)	22.10 (.870)	7.60 (.301)	Yes
14-16 (1.94-1.23)		19011-0037	19011-0038	3.56 (.140)				
10-12 (5.01-3.09)		19011-0039	19011-0040	5.71 (.225)		25.65 (1.010)		

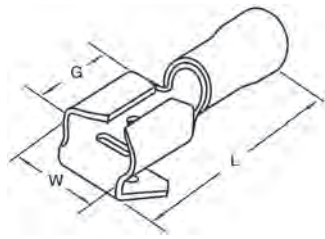

Features and Benefits

- Allows another quick disconnect to be connected to the tab
- Use when multiple connections are required and there is a limited number of male tabs
- Avikrimp provides a metal conductor support sleeve for superior strain relief
- Fulfills the double crimp (support) requirements of VDE and other DIN specifications

Physical

Material: Terminal—Brass
Ferrule—Brass
Insulation—Nylon
Plating: Terminal—Tin
Ferrule—Tin

Avikrimp™

Wire Range AWG (mm ²)	Tab Size	Order No.		Maximum Wire Insulation Diameter	Dimension			Lead-free
		Loose Piece	Mylar Tape		Tab Length (G)	Overall Length (L)	Width (W)	
18-22 (0.96-0.38)	6.35 by 0.81 (.250 by .032)	19012-0029	19012-0030	2.79 (.110)	7.90 (.310)	22.10 (.870)	7.60 (.301)	Yes
14-16 (1.94-1.23)		19012-0031	19012-0032	3.56 (.140)				
10-12 (5.01-3.09)		19012-0033	19012-0034	5.71 (.225)		26.16 (1.030)		

Tab Adapters

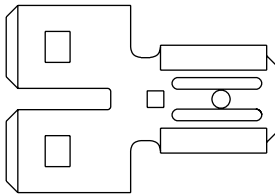

Features and Benefits

- Make two tabs from one when an add-on circuit is needed

Physical

Material: Brass
Plating: See table

Tab Size	Order No.		Lead-free
	Unplated	Tin-Plated	
6.35 (.250) x .813 (.032)	19043-0001	19043-0020	Yes
4.75 (.187) x .508 (.020)	19043-0009		

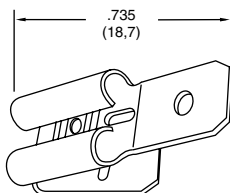

Features and Benefits

- Two male blade angles: 10° bend-up; 120° bend-back
- 6.35mm (.250") tab size converts one Power Block 6.35mm (.250") tab to two tabs

Physical

Material: Brass

Tab Size	Order No.	Lead-free
6.35 (.250) x .813 (.032)	19043-0010	Yes

Quick Disconnects Uninsulated Flag Terminals

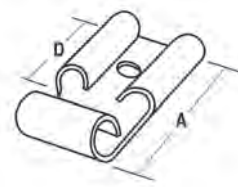

Physical
Material: Brass
Plating: Tin

Krimptite™

Wire Range AWG (mm ²)	Accepts Tab Size	Order No.		Dimension		Lead-free
		Loose Piece	Mylar Tape	Overall Length (A)	Tab Length (D)	
18-22 (0.96-0.38)	6.35 by 0.81 (.250 by .032)	19008-0006	19008-0007	13.69 (.539)	7.92 (.312)	Yes
14-16 (1.94-1.23)		19008-0024	19008-0027	13.69 (.539)	7.92 (.312)	
18-22 (0.96-0.38)	4.75 by 0.81 (.187 by .032)	19008-0002		13.69 (.539)	6.53 (.257)	
14-16 (1.94-1.23)		19008-0020		13.69 (.539)	6.53 (.257)	
18-22 (0.96-0.38)	4.75 by 0.51 (.187 by .020)	19008-0001	19008-0004	13.69 (.539)	6.53 (.257)	
14-16 (1.94-1.23)		19008-0019	19008-0022	13.69 (.539)	6.53 (.257)	



VibraKrimp™ with Wire Grip

Wire Range AWG (mm ²)	Accepts Tab Size	Order No.		Dimension		Maximum Wire Insulation Diameter	Lead-free
		Loose Piece	Mylar Tape	Overall Length (A)	Tab Length (D)		
18-22 (0.96-0.38)	6.35 by 0.81 (.250 by .032)	19009-0001	19009-0002	14.27 (.562)	7.75 (.305)	3.43 (.135)	Yes
14-16 (1.94-1.23)		19009-0010	19009-0011	14.27 (.562)	7.75 (.305)	3.68 (.145)	
18-22 (0.96-0.38)	4.75 by 0.81 (.187 by .032)	19009-0004		14.27 (.562)	6.35 (.250)	3.43 (.135)	
14-16 (1.94-1.23)		19009-0013	19009-0014	14.27 (.562)	6.35 (.250)	3.68 (.145)	
18-22 (0.96-0.38)	4.75 by 0.51 (.187 by .020)	19009-0003	19009-0006	14.27 (.562)	6.35 (.250)	3.43 (.135)	
14-16 (1.94-1.23)		19009-0012	19009-0015	14.27 (.562)	6.35 (.250)	3.68 (.145)	

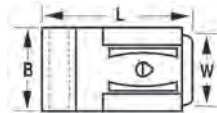

Krimptite™ Economical, No Vibration Support

Wire Range AWG (mm ²)	Tab Size	Order No.		Dimension		Lead-free
		Loose Piece	Mylar Tape	Overall Length (L)	Width (W)	
12-14 (3.09-1.94)	6.35 by 0.81 (.250 by .032)	19008-0038	19008-0039	15.59 (.614)	7.77 (.306)	Yes

Note: Fits hermetic tabs

Temp-Terms Quick Disconnects

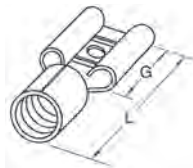

Physical
Material: Steel
Plating: Nickel

483°C (900°F)—Female

Wire Range AWG (mm ²)	Accepts Tab Size	Order No.	Tab Length (G)	Overall Length (L)	Width (W)
14-16 (1.94-1.23)	4.75 by 0.51 (.187 by .020)	19203-0373	6.40 (.252)	14.92 (.587)	6.06 (.239)
	6.35 by 0.81 (.250 by .032)	19203-0390	7.80 (.307)	16.92 (.666)	7.66 (.302)
		19203-0375	8.40 (.331)	14.92 (.587)	
10-12 (5.01-3.09)	6.35 by 0.51 (.250 by .020)	19203-0380		15.72 (.619)	
	6.35 by 0.81 (.250 by .032)	19203-0379	7.80 (.307)	17.92 (.706)	

483°C (900°F)—Male

Wire Range AWG (mm ²)	Tab Size	Order No.	Tab Length (G)	Overall Length (L)	Width (W)
14-16 (1.94-1.23)	6.35 by 0.81 (.250 by .032)	19203-0374		18.32 (.721)	

Tape-Fed and Loose Piece Female Quick Disconnects

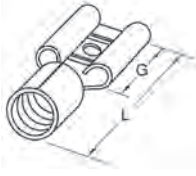

You can order the Quick Disconnect terminals charted here in either loose piece or tape-mounted form. Loose piece versions are individually fed into the dies of manual and powered hand crimping tools. Tape-fed versions are the same terminals mounted on mylar tape for automatic feeding into air- or electric-powered bench crimping presses. Tape-fed terminals are ideal for applications where there are too many terminals for hand tool crimping and too few for strip press crimping. All loose piece and tape-fed terminals have a fully Tin-plated Brass construction with closed electrical barrels.

Features and Benefits

- Quality, one-piece design
- Most economical style and has the greatest variety of uses when special features are not required

Physical

Material: Brass
Plating: Tin

Krimptite™ Butted Seam

Wire Range AWG (mm ²)	Accepts Tab Size	Order No.		Dimension		Lead-free
		Loose Piece	Mylar Tape	Tab Length (G)	Overall Length (L)	
18-22 (0.96-0.38)	6.35 by 0.81 (.250 by .032)	19016-0009	19016-0010	7.87 (.310)	16.70 (.658)	Yes
14-16 (1.94-1.23)		19016-0111	19016-0043		16.26 (.640)	
12-14 (3.09-1.94)		19016-0085	19016-0086		16.70 (.658)	
10-12 (5.01-3.09)		19016-0069	19016-0070		17.80 (.700)	
24-26 (0.22-0.13)	4.75 by 0.81 (.187 by .032)	19016-0099		6.35 (.250)	13.97 (.550)	
18-22 (0.96-0.38)		19016-0006	19016-0007		14.73 (.580)	
14-16 (1.94-1.23)		19016-0040	19016-0041		14.73 (.580)	
12-14 (3.09-1.94)		19016-0082	19016-0083		14.73 (.580)	
24-26 (0.22-0.13)	4.75 by 0.51 (.187 by .020)	19016-0098	19016-0100	6.35 (.250)	13.97 (.550)	
18-22 (0.96-0.38)		19016-0005	19016-0008		14.73 (.580)	
14-16 (1.94-1.23)		19016-0039	19016-0042		14.73 (.580)	
12-14 (3.09-1.94)		19016-0081	19016-0084		14.73 (.580)	
14-16 (1.94-1.23)	5.21 by 0.81 (.205 by .032)	19016-0046	19016-0096	6.35 (.250)	13.97 (.550)	
18-22 (0.96-0.38)		19016-0110	19016-0013		13.97 (.550)	
14-16 (1.94-1.23)		19016-0045	19016-0047		13.97 (.550)	
24-26 (0.22-0.13)		19016-0112	19016-0097		13.46 (.530)	
18-22 (0.96-0.38)	2.79 by 0.81 (.110 by .032)	19016-0003	19016-0004	6.35 (.250)	14.48 (.570)	
14-16 (1.94-1.23)		19016-0037	19016-0038		14.48 (.570)	
24-26 (0.22-0.13)		19016-0075	19016-0076		13.46 (.530)	
18-22 (0.96-0.38)		19016-0001	19016-0002		14.48 (.570)	
14-16 (1.94-1.23)	2.79 by 0.51 (.110 by .020)	19016-0035	19016-0036	6.35 (.250)	14.48 (.570)	

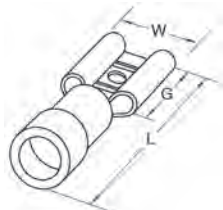

Features and Benefits

- Funnel entrance into electrical barrel eliminates wire strand fold back and increases crimping rates
- PVC sleeve protects against vibration damage by preventing wire flex at the crimp point

Physical

Material: Terminal—Brass
Insulation—PVC
Plating: Tin

InsulKrimp™

Wire Range AWG (mm ²)	Tab Size	Order No.		Dimension		Maximum Wire Insulation Diameter	Lead-free
		Loose Piece	Mylar Tape	Tab Length (G)	Overall Length (L)		
18-22 (0.96-0.38)	6.35 by 0.81 (.250 by .032)	19017-0014	19017-0017	7.90 (.310)	22.35 (.880)	3.40 (.135)	Yes
14-16 (1.94-1.23)		19017-0037	19017-0041		22.35 (.880)	3.70 (.145)	
12-14 (3.09-1.94)		19017-0055	19017-0057		22.35 (.880)	4.40 (.175)	
10-12 (5.01-3.09)		19017-0047	19017-0050		25.40 (1.000)	5.60 (.225)	
18-22 (0.96-0.38)	4.75 by 0.81 (.187 by .032)	19017-0008	19017-0009	6.35 (.250)	20.00 (.789)	3.40 (.135)	
14-16 (1.94-1.23)		19017-0032	19017-0033		20.00 (.789)	3.70 (.145)	
12-14 (3.09-1.94)		19017-0052	19017-0025		20.00 (.789)	4.40 (.175)	
18-22 (0.96-0.38)		19017-0007	19017-0012		20.00 (.789)	3.40 (.135)	
14-16 (1.94-1.23)	4.75 by 0.51 (.187 by .020)	19017-0031	19017-0035	6.35 (.250)	20.00 (.789)	3.70 (.145)	
12-14 (3.09-1.94)		19017-0051	19017-0054		20.00 (.789)	4.40 (.175)	
14-16 (1.94-1.23)		19017-0044	19017-0016		20.00 (.789)	3.70 (.145)	
18-22 (0.96-0.38)		19017-0018	19017-0003		20.00 (.789)	3.40 (.135)	
14-16 (1.94-1.23)	5.21 by 0.51 (.205 by .020)	19017-0043	19017-0046	6.35 (.250)	20.00 (.789)	3.70 (.145)	
18-22 (0.96-0.38)		19017-0005	19017-0006		20.00 (.789)	3.40 (.135)	
14-16 (1.94-1.23)	2.79 by 0.81 (.110 by .032)	19017-0028	19017-0029	6.35 (.250)	20.00 (.789)	3.70 (.145)	

Tape-Fed and Loose Piece Female Quick Disconnects



Features and Benefits

- Vibrakrimp provides a metal insulation support sleeve for strain relief
- Butted seam adds vibration support

Physical
Material: Brass
Plating: Tin

VibraKrimp™

Wire Range AWG (mm ²)	Accepts Tab Size	Order No.		Dimension		Insulation Diameter Range	Lead-free
		Loose Piece	Mylar Tape	Tab Length (G)	Overall Length (L)		
18-22 (0.96-0.38)	6.35 by 0.81 (.250 by .032)	19018-0005	19018-0006	7.90 (.310)	20.40 (.802)	1.50/3.20 (.060/.125)	Yes
14-16 (1.94-1.23)		19018-0014	19018-0015		20.40 (.802)	2.10/3.70 (.085/.145)	
12-14 (3.09-1.94)		19018-0024	19018-0025		20.40 (.802)	2.50/4.40 (.100/.175)	
24-26 (0.22-0.13)	4.75 by 0.81 (.187 by .032)	19018-0045	19018-0046	6.30 (.250)	16.60 (.655)	1.00/2.40 (.040/.095)	
18-22 (0.96-0.38)		19018-0002	19018-0003		17.30 (.682)	1.50/3.20 (.060/.125)	
12-14 (3.09-1.94)		19018-0022	19018-0023		17.30 (.682)	2.50/4.40 (.100/.175)	
24-26 (0.22-0.13)	4.75 by 0.51 (.187 by .020)	19018-0044	19018-0047	6.30 (.250)	16.60 (.655)	1.00/2.40 (.040/.095)	
18-22 (0.96-0.38)		19018-0001	19018-0004		17.30 (.682)	1.50/3.20 (.060/.125)	
14-16 (1.94-1.23)		19018-0011	19018-0013		17.30 (.682)	2.20/3.70 (.085/.145)	
24-26 (0.22-0.13)	2.79 by 0.81 (.110 by .032)	19018-0020	19018-0048	6.30 (.250)	16.60 (.655)	1.00/2.40 (.040/.095)	
18-22 (0.96-0.38)		19018-0008	19018-0009		17.30 (.682)	1.50/3.20 (.060/.125)	
14-16 (1.94-1.23)		19018-0017	19018-0018		17.30 (.682)	2.20/3.70 (.085/.145)	
24-26 (0.22-0.13)	2.79 by 0.51 (.110 by .020)	19018-0019		6.30 (.250)	16.60 (.655)	1.00/2.40 (.040/.095)	
18-22 (0.96-0.38)		19018-0007	19018-0010		17.30 (.682)	1.50/3.20 (.060/.125)	
14-16 (1.94-1.23)		19018-0016			17.30 (.682)	2.20/3.70 (.085/.145)	

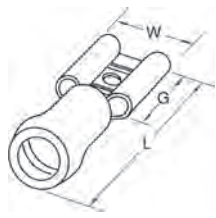

Features and Benefits

- Avikrimp provides a metal insulation support sleeve for superior strain relief
- Fulfills the double crimp (support) requirements of VDE and other DIN specifications

Physical
Material: Terminal—Brass
Ferrule—Brass
Insulation—Nylon
Plating: Terminal—Tin
Ferrule—Tin

AviKrimp™

Wire Range AWG (mm ²)	Tab Size	Order No.		Dimension		Maximum Wire Insulation Diameter	Lead-free
		Loose Piece	Mylar Tape	Tab Length (G)	Overall Length (L)		
18-22 (0.96-0.38)	6.35 by 0.81 (.250 by .032)	19019-0012	19019-0013	7.90 (.310)	22.00 (.865)	2.90 (.115)	Yes
14-16 (1.94-1.23)		19019-0031	19019-0033		22.00 (.865)	3.50 (.138)	
12-14 (3.09-1.94)		19019-0052	19019-0054		22.00 (.865)	4.30 (.170)	
10-12 (5.01-3.09)		19019-0037	19019-0038		25.70 (1.011)	5.70 (.225)	
24-26 (0.22-0.13)	4.75 by 0.81 (.187 by .032)	19019-0044	19019-0045	6.30 (.250)	17.60 (.694)	1.80 (.072)	
18-22 (0.96-0.38)		19019-0008	19019-0009		20.00 (.789)	2.90 (.115)	
14-16 (1.94-1.23)		19019-0028	19019-0029		20.00 (.789)	3.50 (.138)	
12-14 (3.09-1.94)		19019-0049	19019-0050		20.00 (.789)	4.30 (.170)	
24-26 (0.22-0.13)	4.75 by 0.51 (.187 by .020)	19019-0043	19019-0046	6.30 (.250)	17.60 (.694)	1.80 (.072)	
18-22 (0.96-0.38)		19019-0006	19019-0011		20.00 (.789)	2.90 (.115)	
14-16 (1.94-1.23)		19019-0027	19019-0030		20.00 (.789)	3.50 (.138)	
12-14 (3.09-1.94)		19019-0048	19019-0051		20.00 (.789)	4.30 (.170)	
18-22 (0.96-0.38)	5.21 by 0.81 (.205 by .032)	19019-0015	19019-0058	6.30 (.250)	20.00 (.789)	2.90 (.115)	
14-16 (1.94-1.23)		19019-0035	19019-0063		20.00 (.789)	3.50 (.138)	
18-22 (0.96-0.38)	5.21 by 0.51 (.205 by .020)	19019-0014	19019-0016	6.30 (.250)	20.00 (.789)	2.90 (.115)	
14-16 (1.94-1.23)		19019-0034	19019-0064		20.00 (.789)	3.50 (.138)	
24-26 (0.22-0.13)	2.79 by 0.81 (.110 by .032)	19019-0041	19019-0042	6.30 (.250)	17.60 (.694)	1.80 (.072)	
18-22 (0.96-0.38)		19019-0004	19019-0005		20.00 (.789)	2.90 (.115)	
14-16 (1.94-1.23)	2.79 by 0.51 (.110 by .020)	19019-0025	19019-0026	6.30 (.250)	20.00 (.789)	3.50 (.138)	
24-26 (0.22-0.13)		19019-0039	19019-0040		17.60 (.694)	1.80 (.072)	
18-22 (0.96-0.38)	2.79 by 0.51 (.110 by .020)	19019-0001	19019-0003	6.30 (.250)	20.00 (.789)	2.90 (.115)	
14-16 (1.94-1.23)		19019-0022	19019-0024		20.00 (.789)	3.50 (.138)	

Tape-Fed and Loose Piece Male Quick Disconnects



Features and Benefits

- Quality one-piece design
- Most economical style and has the greatest variety of uses where special features are not required

Physical

Material: Copper Alloy
Plating: Zinc Chromate

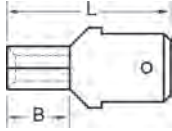

Krimptite™ Economical, No Vibration Support

Wire Range AWG (mm ²)	Tab Size	Order No.		Dimension		Lead-free
		Loose Piece	Mylar Tape	Barrel Length (B)	Overall Length (L)	
18-22 (0.96-0.38)	6.35 by 0.81 (.250 by .032)	19022-0004	19022-0010	6.22 (.245)	18.34 (.722)	Yes
14-16 (1.94-1.23)		19022-0018	19022-0026	6.50 (.254)	17.91 (.705)	
10-12 (5.01-3.09)		19022-0015	19022-0017	6.50 (.254)	19.05 (.750)	
18-22 (0.96-0.38)	4.75 by 0.51 (.187 by .020)	19022-0006	19022-0009	6.50 (.254)	16.00 (.630)	
14-16 (1.94-1.23)		19022-0022	19022-0024	6.50 (.254)	16.00 (.630)	

Features and Benefits

- VibraKrimp™ provides a metal insulation support sleeve for strain relief.

Physical

Material: Terminal—Copper Alloy
Ferrule—Brass
Plating: Terminal—Tin
Ferrule—Tin

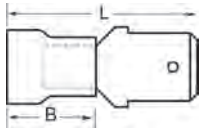

VibraKrimp™

Wire Range AWG (mm ²)	Tab Size	Order No.		Dimension		Maximum Wire Insulation Diameter	Lead-free
		Loose Piece	Mylar Tape	Barrel Length (B)	Overall Length (L)		
18-22 (0.96-0.38)	6.35 by 0.81 (.250 by .032)	19024-0001	19024-0004	10.20 (.402)	21.77 (.857)	3.60 (.140)	Yes
14-16 (1.94-1.23)		19024-0007	19024-0009	10.20 (.402)	21.77 (.857)	4.30 (.170)	
14-16 (1.94-1.23)	4.75 by 0.51 (.187 by .020)	19024-0008		10.20 (.402)	19.25 (.758)	4.30 (.170)	



Features and Benefits

- Funnel entrance into electrical barrel eliminates wire strand fold back and increases crimping rates
- PVC sleeve protects against vibration damage by preventing wire flex at the crimp point

Physical

Material: Terminal—Copper Alloy
Insulation—PVC
Plating: Tin

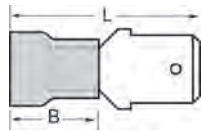

InsulKrimp™

Wire Range AWG (mm ²)	Tab Size	Order No.		Dimension		Maximum Wire Insulation Diameter	Lead-free
		Loose Piece	Mylar Tape	Barrell Length (B)	Overall Length (L)		
18-22 (0.96-0.38)	6.30 by 0.81 (.250 by .032)	19023-0005	19023-0006	11.40 (.450)	23.20 (.915)	3.70 (.145)	Yes
14-16 (1.94-1.23)		19023-0012	19023-0014	11.40 (.450)	23.20 (.915)	4.40 (.175)	
10-12 (5.01-3.09)		19023-0008	19023-0009	13.80 (.545)	27.90 (1.10)	6.40 (.250)	
18-22 (0.96-0.38)	4.75 by 0.51 (.187 by .020)	19023-0003	19023-0004	11.40 (.450)	20.80 (.820)	3.70 (.145)	
14-16 (1.94-1.23)		19023-0010	19023-0011	11.40 (.450)	20.80 (.820)	4.40 (.175)	

Tape-Fed and Loose Piece Male Quick Disconnects



Features and Benefits

- Avikrimp provides a metal insulation support sleeve for superior strain relief
- Fulfills the double crimp (support) requirements of VDE and other DIN specifications

Physical

Material: Terminal—Copper Alloy
 Ferrule—Brass
 Insulation—Nylon
 Plating: Terminal—Zinc Chromate
 Ferrule—Tin

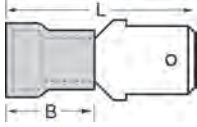

Avikrimp™

Wire Range AWG (mm ²)	Tab Size	Order No.		Dimension		Maximum Wire Insulation Diameter	Lead-free
		Loose Piece	Mylar Tape	Barrel Length (B)	Overall Length (L)		
18-22 (0.96-0.38)	6.35 by 0.81 (.250 by .032)	19025-0001	19025-0004	13.87 (.546)	25.40 (1.00)	6.30 (.140)	Yes
14-16 (1.94-1.23)		19025-0007	19025-0010	13.87 (.546)	25.40 (1.00)	4.30 (.170)	
10-12 (5.01-3.09)		19025-0005	19025-0006	16.99 (.669)	29.97 (1.18)	5.70 (.225)	
18-22 (0.96-0.38)	4.75 by 0.51 (.187 by .020)	19025-0002	19025-0003	13.87 (.546)	20.83 (.820)	6.30 (.140)	
14-16 (1.94-1.23)		19025-0008	19025-0009	13.87 (.546)	20.83 (.820)	4.30 (.170)	

Quick Disconnects

Metal Strip Female Quick Disconnects



Features and Benefits

- T-shape carrier links each terminal and automatically delivers them into crimping press dies to boost production rates
- Funnel entrance into electrical barrel eliminates wire strand fold back and increase crimping rates
- PVC sleeve protects against vibration damage by preventing wire flex at the crimp point

Physical

Material: Brass
 Material: Terminal—Brass
 Insulation—PVC
 Plating: Tin

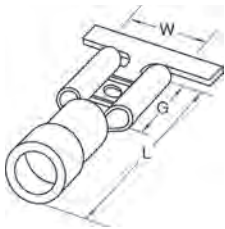

InsulKrimp™

Wire Range AWG (mm ²)	Tab Size	Tin-Plated Order No.	Dimension		Maximum Wire Insulation Diameter	Lead-free
			Tab Length (G)	Overall Length (L)		
14-16 (1.94-1.23)	6.35 by 0.81 (.250 by .032)	19017-0074	7.90 (.310)	22.40 (.880)	3.70 (.145)	Yes
12-14 (3.09-1.94)		19017-0107			4.40 (.175)	
14-16 (1.94-1.23)	4.75 by 0.81 (.187 by .032)	19017-0073	6.30 (.250)	19.80 (.780)	3.70 (.145)	
12-14 (3.09-1.94)		19017-0059			4.40 (.175)	
14-16 (1.94-1.23)	4.75 by 0.51 (.187 by .020)	19017-0072	6.30 (.250)	19.80 (.780)	3.70 (.145)	
12-14 (3.09-1.94)		19017-0083			4.40 (.175)	
14-16 (1.94-1.23)	2.79 by 0.81 (.110 by .032)	19017-0071	6.30 (.250)	19.80 (.780)	3.70 (.145)	
14-16 (1.94-1.23)	2.79 by 0.51 (.110 by .020)	19017-0070			3.70 (.145)	

Metal Strip Female Quick Disconnects



Features and Benefits

- Avikrimp provides a metal insulation support sleeve for superior strain relief
- Fulfills the double crimp (support) requirements of VDE and other DIN specifications

Physical

Material: Terminal—Brass
 Ferrule—Brass
 Insulation—Nylon
 Plating: Terminal—Tin
 Ferrule—Tin

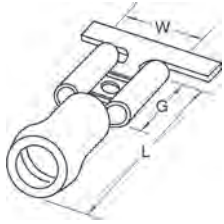

Avikrimp™

Wire Range AWG (mm ²)	Tab Size	Tin-Plated Order No.	Dimension		Maximum Wire Insulation Diameter	Lead-free
			Tab Length (G)	Overall Length (L)		
18-22 (0.96-0.38)	6.35 by 0.81 (.250 by .032)	19019-0020	7.90 (.310)	22.00 (.865)	2.90 (.115)	Yes
14-16 (1.94-1.23)		19019-0036		22.00 (.865)	3.50 (.138)	
12-14 (3.09-1.94)		19019-0057		22.00 (.865)	4.30 (.170)	
24-26 (0.22-0.13)	4.75 by 0.81 (.187 by .032)	19019-0083	6.30 (.250)	17.60 (.694)	1.80 (.072)	
18-22 (0.96-0.38)		19019-0019		20.00 (.789)	2.90 (.115)	
14-16 (1.94-1.23)		19019-0080		20.00 (.789)	3.50 (.138)	
12-14 (3.09-1.94)		19019-0056		20.00 (.789)	4.30 (.170)	
24-26 (0.22-0.13)	4.75 by 0.51 (.187 by .020)	19019-0082	6.30 (.250)	17.60 (.694)	1.80 (.072)	
14-16 (1.94-1.23)		19019-0079		20.00 (.789)	3.50 (.138)	
12-14 (3.09-1.94)		19019-0055		20.00 (.789)	4.30 (.170)	
24-26 (0.22-0.13)	2.79 by 0.81 (.110 by .032)	19019-0081	6.30 (.250)	17.60 (.694)	1.80 (.072)	
18-22 (0.96-0.38)		19019-0075		20.00 (.789)	2.90 (.115)	
24-26 (0.22-0.13)	2.79 by 0.51 (.110 by .020)	19019-0047	6.30 (.250)	17.60 (.694)	1.80 (.072)	

Quick Disconnects

Metal Strip Quick Disconnects Uninsulated Female Flag Terminals



Features and Benefits

- Quality, one-piece design
- The most economical style has the greatest variety of uses where special features are not required

Physical

Material: Brass
 Plating: Tin

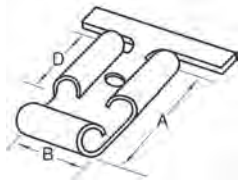

Krimptite™

Wire Range AWG (mm ²)	Tab Size	Order No.	Dimension			Lead-free
			Overall Length (A)	Barrel Length (B)	Tab Length (D)	
18-22 (0.96-0.38)	6.30 by 0.80 (.250 by .032)	19008-0013	13.70 (.539)	7.90 (.312)	7.90 (.312)	Yes
	4.70 by 0.80 (.187 by .032)	19008-0009			7.90 (.312)	
	4.70 by 0.50 (.187 by .020)	19008-0008			6.50 (.257)	
14-16 (1.94-1.23)	6.30 by 0.80 (.250 by .032)	19008-0031			7.90 (.312)	
	4.70 by 0.80 (.187 by .032)	19008-0029			6.50 (.257)	
	4.70 by 0.50 (.187 by .020)	19008-0028			6.50 (.257)	

Flag Terminal Quick Disconnects



Features and Benefits

- VibraKrimp™ provides a metal insulation support sleeve for strain relief

Physical

Material: Brass
Plating: Tin

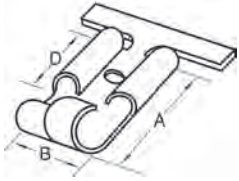

VibraKrimp™

Wire Range AWG (mm ²)	Tab Size	Order No.	Dimension			Maximum Wire Insulation Diameter	Lead-free
			Overall Length (A)	Barrel Length (B)	Tab Length (D)		
18-22 (0.80-0.35)	6.35 by 0.81 (.250 by .032)	19009-0007	14.30 (.562)	9.80 (.385)	7.70 (.305)	3.40 (.135)	Yes
	4.75 by 0.81 (.187 by .032)	19009-0009			6.30 (.250)	3.40 (.135)	
	4.75 by 0.51 (.187 by .020)	19009-0008			6.30 (.250)	3.40 (.135)	
14-16 (2.00-1.30)	6.35 by 0.81 (.250 by .032)	19009-0016			7.70 (.305)	3.70 (.145)	
	4.75 by 0.81 (.187 by .032)	19009-0018			6.30 (.250)	3.70 (.145)	
	4.75 by 0.51 (.187 by .020)	19009-0017			6.30 (.250)	3.70 (.145)	

Quick Disconnect Terminals For PC Board



Molex PC Board Quick Disconnect terminals are available in tab sizes ranging from 2.79 by 0.51mm (.110 by .020") to 6.35 by 0.81mm (.250 by .032.") Products are available in both vertical and right angle mounting configurations. All products are manufactured to NEMA specifications and are UL and CSA recognized.

Physical

Material: Brass
 Thickness: 0.813mm (.032")
 Plating: Tin 3.81µm (150µ") over 1.27µm (50µ") Nickel min. thickness

Molex offers a large selection of Standard Printed Circuit Board-Mountable quick disconnect terminals. Some products offer a tab support mounting feature providing increased mounting reliability and terminal strength. Products are available as strip applied and loose piece. All products can be easily inserted into printed circuit boards using widely available, industry standard bench-type, and fully-automated XY insertion tooling.

Quick Disconnects

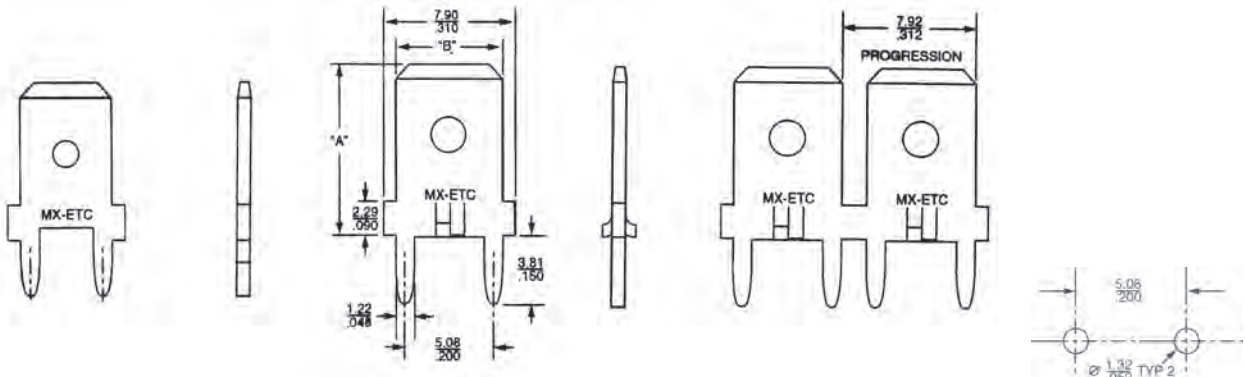

Recommended PCB Hole Layout

Order No.	Carrier	Tab Support	Dimension		Tab Thickness	Lead-free
			Mounted Height (A)	Tab Size (B)		
19705-4001	Loose	Yes	14.20 (.560)	6.35 (.250)	0.81 (.032)	Yes
19705-4003	Strip					
19705-4201	Loose					
19705-4203	Strip					
19705-4301	Loose	No	10.30 (.405)	4.75 (.187)	0.51 (.020)	
19705-4303	Strip		10.30 (.405)			
19705-4101	Loose	Yes	14.20 (.560)	4.75 (.187)	0.81 (.032)	
19705-4103	Strip					
19708-4001	Loose	No	9.14 (.360)	.345 (8.77)	0.51 (.020)	
19708-4003	Strip					
19708-4011	Loose					
19708-4013	Strip					
19708-4023	Strip	Yes				
19708-4033						

Quick Disconnect Terminals For PC Board

Vertical
 Tab Size—2.79mm (.110")

Physical

Material: Brass
 Thickness: 0.51mm (.020")
 Plating: Tin 3.81µm (150µ") over 1.27µm (50µ") Nickel min. thickness

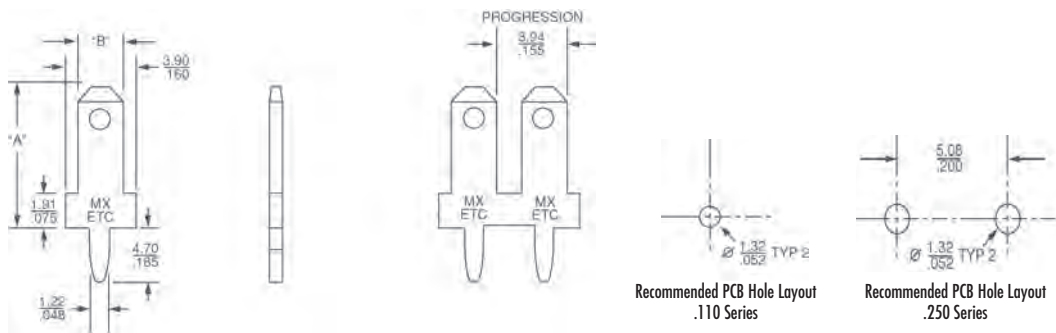

Recommended PCB Hole Layout
.110 Series

Recommended PCB Hole Layout
.250 Series

Order No.	Carrier	Dimension		Lead-free
		Mounted Height (A)	Tab Size (B)	
19712-4001	Loose	9.19 (.362)	2.79 (.110)	Yes
19712-4003	Strip			



Quick Disconnect Terminals for PC Board Right Angle Tab Size—6.35mm (.250")

Physical
Material: Brass
Thickness: 0.813mm (.032")
Plating: Tin 3.81µm (150µ")
over Nickel 1.27µm (50µ")

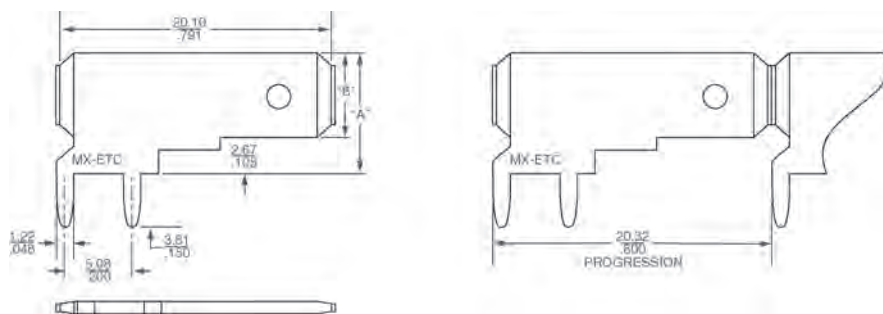

Order No.	Carrier	Dimension		Lead-free
		Mounted Height (A)	Tab Size (B)	
19713-4001	Loose	9.02 (.355)	6.35 (.250)	Yes
19713-4003	Strip			

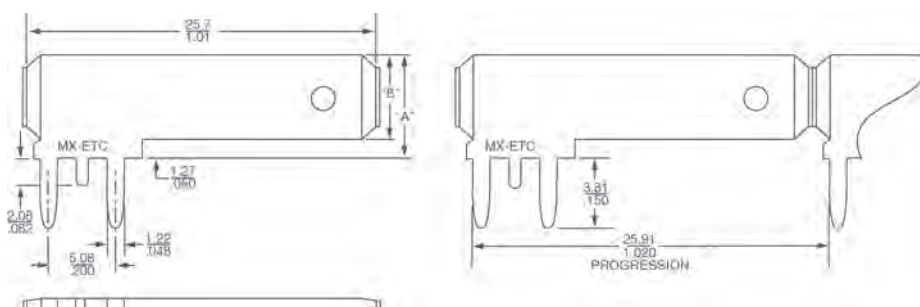

Physical
Material: Brass
Thickness: 0.813mm (.032")
Plating: Tin 3.81µm (150µ") over Nickel 127µm (50µ") min. thickness

Order No.	Carrier	Dimension		Lead-free
		Mounted Height (A)	Tab Size (B)	
19711-4201	Loose	7.62 (.300)	6.35 (.250)	Yes
19711-4203	Strip			

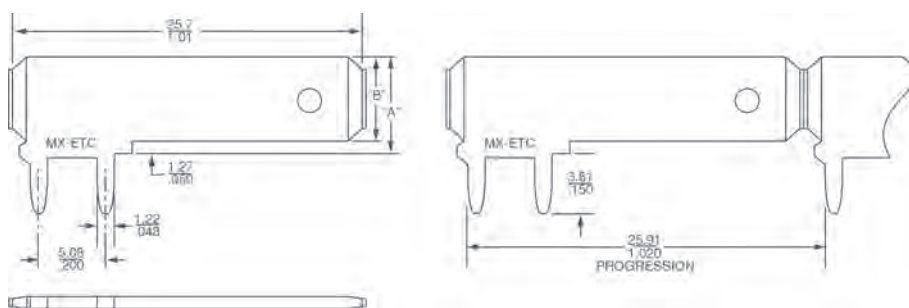

Physical
Material: Brass
Thickness: 0.813mm (.032")
Plating: Tin 5.00µm (200µ") over Copper

Special Plating

Order No.	Carrier	Dimension		Hole	Lead-free
		Mounted Height (A)	Tab Size (B)		
19711-4001	Loose	7.62 (.300)	6.35 (.250)	Yes	Yes
19711-4003	Strip				
19711-4005	Loose			No	
19711-4007	Strip				

Wire Management

Wire Connectors	D-3 to D-4
Cable Ties and Mounting Pads	D-5
PermaFit™ Heat Shrink Tubing	D-6 to D-16

Wire Management Products



Closed-End Connectors

Molex nylon closed-end connectors feature two-piece construction. A translucent nylon insulator is adhered to the pure electrolytic, copper insert. Closed-end connectors are used in a wide variety of situations to "pigtail" two or more wires together, and can be used as a dead end splice or one power line and multiple lead offs.

Wire Connectors

Molex Wire Connectors offer a cost effective way to produce safe and secure wire connections. The tough, thermoplastic shell provides UL-94V2 flame retardant protection while the fixed square-wire spring construction offers a secure connection that will not relax over time.

Standard Twist Locks feature a threaded funnel entry to easily guide wires into the connector.

Wing Locks offer deep gripping ribs and swept-back wings that permit a higher torque.

High Temp Wire Connectors are used in applications that require continued exposure to heat.

Cable Ties

Molex offers a full line of standard cable ties as well as selected mounting and identification ties. Our cable ties are constructed from durable nylon 6/6 and offer a compact, one piece design. These industry standard products are designed to meet or exceed the MIL-S-23190E tensile strength requirements.

Heat Shrink Tubing

Molex offers a wide variety of heat shrink tubing including thin-wall, adhesive-lined dual-wall and heavy-wall polyolefin tubing as well as heat shrinkable PVC.

Thin (single) wall is high quality tubing with a wide variety of uses. It is made from flame retardant polyolefin, giving it excellent physical, chemical and electrical properties that meet industrial and military requirements for highly reliable, general-purpose tubing.

Dual-wall tubing is adhesive lined, and manufactured using fully flame retardant polyolefin tubing which offers superior strain relief as well as environmental sealing capabilities.

Heavy-wall tubing is UL rated for direct burial applications. This tubing is chemically cross linked during manufacturing which ensures that it will not split or rupture during installation, even if overheated.

Our economical PVC tubing has a longitudinal shrinkage of approximately 20% allowing ripple free conformance around sharp bends such as appliance handles and bus bars.

Nylon Insulated, Closed-End Connectors



Molex Nylon Closed-End Connectors feature a 2-piece construction. A translucent nylon-molded insulation is adhered to the metal connector insert. The connector's insert is annealed, Tin-plated, seamless, pure electrolytic, tough pitch Copper. Individual design and performance requirements dictate the use of Copper inserts.

Physical
 Material: Insert—Copper
 Insulation—Nylon
 Plating: Tin

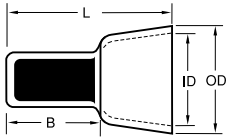

Wire Range AWG (mm ²)	Circular Mil Area	Order No.		Barrel Length (B)	Overall Length (L)	Outside Diameter (OD)	Inside Diameter (ID)	Lead-free
		Loose Piece	Mylar Tape					
14-22 (1.94-0.38)	3831-754	19160-0012	19160-0070	10.92 (.430)	15.50 (.610)	7.80 (.310)	6.60 (.260)	Yes
12-22 (3.09-0.38)	6008-754	19160-0009	19160-0071	9.40 (.370)	21.84 (.860)	8.90 (.350)	7.10 (.280)	
10-16 (5.01-1.23)	9880-2426	19160-0002	19160-0083	9.91 (.390)	22.86 (.900)	11.20 (.440)	9.60 (.380)	
8 (7.96)	15700	19160-0024	19160-0028	10.90 (.430)	27.70 (1.090)	14.20 (.560)	12.70 (.500)	

D

Wire Management

Connector Inserts

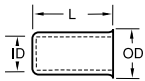

Molex Connector Inserts are the same annealed, Tin-plated, seamless pieces used in the nylon-insulated, closed-end connectors above. These inserts are used in applications where insulation is not essential.

Physical
 Material: Copper
 Plating: Tin

Wire Range AWG (mm ²)	Circular Mil Area	Order No.	Overall Length (L)	Outside Diameter (OD)	Inside Diameter (ID)	Lead-free
14-22 (1.94-0.38)	3831-754	19160-0025	7.92 (.314)	3.61 (.142)	2.29 (.090)	Yes
12-22 (3.09-0.38)	6008-754	19160-0022	8.05 (.317)	4.22 (.166)	2.64 (.104)	
10-16 (5.01-1.23)	9880-2426	19160-0014	7.47 (.294)	5.56 (.219)	3.84 (.151)	
8 (7.96)	15700	19160-0029	11.05 (.435)	7.67 (.302)	5.59 (.220)	

Twist Lock Wire Connectors



A cone shaped, plated steel spring conforms to the inside contour of the insulating shell, which supports the spring as the conductor is driven up into the cone. Requiring no pretwisting, the wires are automatically twisted together for a secure connection and maximum contact. Fixed spring wire connectors may be used to make branch circuit or fixture wire connections on numerous combinations of solid and/or stranded wire.

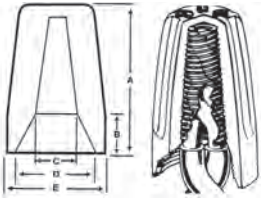

Copper Wire Only			Order No.	Length (A)	Dimensions			Width (E)	Lead-free
Wire Range AWG (mm ²)	Minimum	Maximum			B	C	D		
16-22 (1.23-0.38)	1 #22 and 1 #20	2 #16	19160-0039	14.7 (.578)	4.37 (.172)	3.18 (.125)	6.35 (.250)	8.33 (.328)	Yes
16-22 (1.23-0.38)	3 #22	3 #16	19160-0040	17.9 (.703)	4.37 (.172)	4.76 (.188)	7.94 (.313)	9.92 (.391)	
14-22 (1.94-0.38)	3 #20	4 #16 and 1 #20	19160-0041	21.4 (.844)	8.33 (.328)	5.16 (.203)	8.73 (.344)	11.1 (.438)	
10-18 (5.01-0.96)	1 #14 and 1 #18	4 #14	19160-0042	23.8 (.938)	6.75 (.266)	5.95 (.234)	11.1 (.438)	13.9 (.547)	
10-18 (5.01-0.96)	2 #14	2 #10 and 2 #12	19160-0043	27.0 (1.06)	6.75 (.266)	8.33 (.328)	13.5 (.531)	16.7 (.656)	

Wing Lock Wire Connectors

A square wire, coiled spring expands freely within the tough plastic shell and can accommodate a wide range of wire combinations. The angled edges of the spring attach to the conductor as the connector is twisted on for an easily secured joint. The spring applies even pressure over the entire contact area and provides a low resistance connection and mechanical strength against pull and vibration.

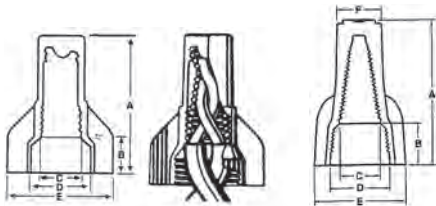

19160-0046
(with through-hole for grounding)

Copper Wire Only			Order No.	Dimensions						Lead-free
Wire Range AWG (mm ²)	Minimum	Maximum		Length (A)	B	C	D	Width (E)	F	
10-22 (5.01-0.38)	2 #18	3 #12	19160-0044	26.2 (1.03)	7.94 (.313)	5.57 (.219)	6.35 (.250)	18.3 (.719)		Yes
10-18 (5.01-0.96)	2 #14	5 #12	19160-0045	31.8 (1.25)	7.94 (.313)	7.14 (.281)	11.1 (.438)	23.0 (.906)		
6-22 (13.48-0.38)	3 #22	4 #12 and 2 #18	19160-0046	18.7 (.734)	14.3 (.563)	7.94 (.313)	8.33 (.328)	29.4 (1.16)	7.94 (.313)	
6-14 (13.48-1.94)	1 #10 and 1 #12	1 #6 and 2 #8STR	19160-0047	38.1 (1.50)	11.1 (.438)	9.53 (.375)	19.1 (.750)	31.8 (1.25)		

Note: Molex connectors must withstand extreme dielectric voltage tests to determine performance. All connectors are UL listed and CSA certified as Pressure-Type wire connectors for 600V max., building wire; 1000V max., signs or fixtures and comply with Federal Specification W-S-610d. Temperature rating 105°C (221°F) max.

General Purpose Cable Ties

Features and Benefits

- Bundle cables and wires to easily organize and identify
- Cable ties exceed minimum tensile strength

Physical

Material: Nylon

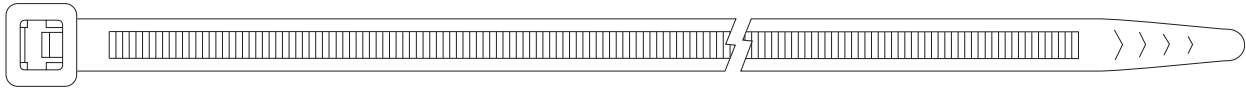

Style	Minimum Tensile Strength	Order No.	Length	Width	Maximum Bundle Diameter	Color
Miniature	80.10 (18 lb)	19252-0124	101.6 (4.00)	2.54 (.100)	2.49 (.980)	Natural
		19252-0129				Natural
		19252-0130				UV Black
		19252-0131				UV Black
		19252-0132	154.94 (6.10)		H.R. Black	
		19252-0125			Natural	
		19252-0133	UV Black			
		19252-0134	195.58 (7.70)		Natural	
19252-0135	UV Black					
Intermediate	177.93N (40 lb)	19252-0136	149.86 (5.90)	3.56 (.140)	38.1 (1.5)	Natural
		19252-0137				Natural
		19252-0138				UV Black
		19252-0139	203.2 (8.00)		57.15 (2.25)	Natural
		19252-0140			UV Black	
		19252-0141	299.72 (11.80)		87.12 (3.43)	Natural
		19252-0142			UV Black	
		19252-0143	368.3 (14.50)		109.98 (4.33)	Natural
		19252-0144			UV Black	
		Standard	222.41N (50 lb)		19252-0145	185.42 (7.30)
19252-0146	Natural					
19252-0147	UV Black					
19252-0148	UV Black					
19252-0149	287.02 (11.30)			82.80 (3.26)	Natural	
19252-0150					Natural	
19252-0151					UV Black	
19252-0152					UV Black	
19252-0153	368.30 (14.50)			108.97 (4.29)	Natural	
19252-0154					UV Black	
19252-0155					UV Black	
19252-0156					Natural	
Heavy Duty	533.79N (120 lb)	19252-0157	368.30 (14.50)	7.62 (.300)	107.95 (4.25)	UV Black

D

Wire Management

Mounting Hole Cable Ties

Features and Benefits

- Bundling and mounting are done with on unit
- Cable ties exceed minimum tensile strength

Physical

Material: Nylon

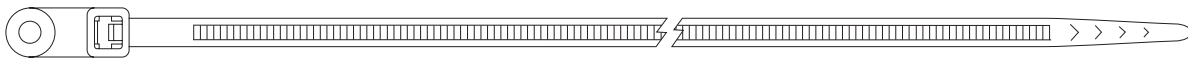

Mounting Stud Size	Minimum Tensile Strength	Order No.	Length	Width	Maximum Bundle Diameter	Color
8	133.45N (30 lb)	19252-0158	149.86(5.90)	3.56 (.140)	35.05 (1.38)	Natural
10		19252-0159				Natural
10	222.41(50 lb)	19252-0160	203.2 (8.00)	4.83 (.190)	55.88 (2.20)	UV Black
1/4		19252-0161				368.30 (14.50)

Mounting Bases

Features and Benefits

- Adhesive backing makes mounting the base simple and fast

Physical

Material: Nylon

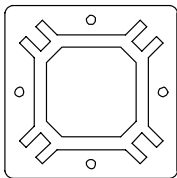

Order No.	Size	Mounted Height	Slot Height
19252-0162	19.05 by 19.05 (.75 by .75)	2.54 (.10)	4.06 (.160)
19252-0163	25.40 by 25.40 (1.00 by 1.00)	5.08 (.20)	5.08 (.200)

Perma-Fit™ Polyolefin Multi-Purpose Heat Shrink Tubing

19267
Thin Wall

Features and Benefits

- High-quality tubing with a wide variety of uses
- Made from flame-retardant Polyolefin
- Excellent physical, chemical, and electrical properties
- Meets industrial and military requirements for highly reliable, general purpose tubing

Mechanical

Shrink Ratio 2:1
Minimum Shrink Temperature: 90°C (all other colors)

Physical

Material: Polyolefin
Continuous Operating Temperature: -55 to +135°C

Reference Information

Colors: Black and clear (all sizes); White, Red, Blue, and Yellow

Meets Mil-1-23053/5 Class 1 (colors), Class 2 (clear)
UL recognized and CSA certified (colors only)

Wire Management

D

Order No.	Size (Diameter)	Minimum Expanded	Maximum Recovery	Nominal Recovery Wall Thickness	Length m (ft)	Package Quantity	Color	Lead-free
19267-0015	1.194 (0.047)	1.626 (0.064)	0.584 (0.023)	0.457 (0.018)	1.22 (4.00)	25/pkg	Black	Yes
19267-0016							White	
19267-0017							Red	
19267-0018							Blue	
19267-0019							Clear	
19267-0020							Yellow	
19267-0021					0.15 (.500)	200/pkg	Black	
19267-0022							White	
19267-0023							Red	
19267-0024							Blue	
19267-0025							Clear	
19267-0026							Yellow	
19267-0027					0.30 (1.00)	100/pkg	Black	
19267-0028							White	
19267-0029							Red	
19267-0030							Blue	
19267-0031							Clear	
19267-0032							Yellow	
19267-0033					304.8 (1000)	Spool	Black	
19267-0034							White	
19267-0035							Red	
19267-0036							Blue	
19267-0037							Clear	
19267-0038							Yellow	
19267-0039	30.48 (100)	Spool	Black					
19267-0040			White					
19267-0041			Red					
19267-0042			Blue					
19267-0043			Clear					
19267-0044			Yellow					
19267-0045	1.600 (0.063)	1.600 (0.063)	0.787 (0.031)	0.457 (0.018)	1.22 (4.00)	25/pkg	Black	
19267-0046							White	
19267-0047							Red	
19267-0048							Blue	
19267-0049							Clear	
19267-0050							Yellow	
19267-0051					0.15 (.500)	200/pkg	Black	
19267-0052							White	
19267-0053							Red	
19267-0054							Blue	
19267-0055							Clear	
19267-0056							Yellow	
19267-0057					0.30 (1.00)	100/pkg	Black	
19267-0058							White	
19267-0059							Red	
19267-0060							Blue	
19267-0061							Clear	
19267-0062							Yellow	
19267-0063					304.8 (1000)	Spool	Black	
19267-0064							White	
19267-0065							Red	
19267-0066							Blue	
19267-0067							Clear	
19267-0068							Yellow	

Perma-Fit™ Polyolefin Multi-Purpose Heat Shrink Tubing

19267
Thin Wall

Features and Benefits

- High-quality tubing with a wide variety of uses
- Made from flame-retardant Polyolefin
- Excellent physical, chemical, and electrical properties
- Meets industrial and military requirements for highly reliable, general purpose tubing

Reference Information

Colors: Black and clear (all sizes); White, Red, Blue, and Yellow
Meets Mil-1-23053/5 Class 1 (colors), Class 2 (clear)
UL recognized and CSA certified (colors only)

Mechanical

Shrink Ratio 2:1
Minimum Shrink Temperature: 90°C (all other colors)

Physical

Material: Polyolefin
Continuous Operating Temperature: -55 to +135°C

Order No.	Size (Diameter)	Minimum Expanded	Maximum Recovery	Nominal Recovery Wall Thickness	Length m (ft)	Package Quantity	Color	Lead-free			
19267-0069	1.600 (0.063)	1.600 (0.063)	0.787 (0.031)	0.457 (0.018)	30.48 (100)	Spool	Black	Yes			
19267-0070							White				
19267-0071							Red				
19267-0072							Blue				
19267-0073							Clear				
19267-0074							Yellow				
19267-0075	2.362 (0.093)	2.362 (0.093)	1.168 (0.046)	0.508 (0.020)	1.22 (4.00)	25/pkg	Black				
19267-0076							White				
19267-0077							Red				
19267-0078							Blue				
19267-0079							Clear				
19267-0080							Yellow				
19267-0081					0.15 (.500)	200/pkg	0.508 (0.020)		0.30 (1.00)	100/pkg	Black
19267-0082											White
19267-0083											Red
19267-0084											Blue
19267-0085											Clear
19267-0086											Yellow
19267-0087	304.8 (1000)	304.8 (1000)	0.508 (0.020)	0.30 (1.00)	Spool	Black					
19267-0088						White					
19267-0089						Red					
19267-0090						Blue					
19267-0091						Clear					
19267-0092						Yellow					
19267-0093						30.48 (100)	30.48 (100)	0.508 (0.020)	0.30 (1.00)	100/pkg	Black
19267-0094											White
19267-0095											Red
19267-0096											Blue
19267-0097											Clear
19267-0098											Yellow
19267-0099	3.175 (0.125)	3.175 (0.125)	1.575 (0.062)	0.508 (0.020)	1.22 (4.00)	25/pkg	Black				
19267-0100							White				
19267-0101							Red				
19267-0102							Blue				
19267-0103							Clear				
19267-0104							Yellow				
19267-0105					0.15 (.500)	200/pkg	0.508 (0.020)	0.30 (1.00)	100/pkg	Black	
19267-0106										White	
19267-0107										Red	
19267-0108										Blue	
19267-0109										Clear	
19267-0110										Yellow	
19267-0111	304.8 (1000)	304.8 (1000)	0.508 (0.020)	0.30 (1.00)	Spool	Black					
19267-0112						White					
19267-0113						Red					
19267-0114						Blue					
19267-0115						Clear					
19267-0116						Yellow					
19267-0117						30.48 (100)	30.48 (100)	0.508 (0.020)	0.30 (1.00)	100/pkg	Black
19267-0118											White
19267-0119											Red
19267-0120											Blue
19267-0121											Clear
19267-0122											Yellow
19267-0123	30.48 (100)	30.48 (100)	0.508 (0.020)	0.30 (1.00)	Spool	Black					
19267-0124						White					
19267-0125						Red					
19267-0126						Blue					
19267-0127						Clear					
19267-0128						Yellow					
19267-0129	30.48 (100)	30.48 (100)	0.508 (0.020)	0.30 (1.00)	Spool	Black					
19267-0130						White					

D

Wire Management

Perma-Fit™ Polyolefin Multi-Purpose Heat Shrink Tubing

19267
Thin Wall

Features and Benefits

- High-quality tubing with a wide variety of uses
- Made from flame-retardant Polyolefin
- Excellent physical, chemical, and electrical properties
- Meets industrial and military requirements for highly reliable, general purpose tubing

Mechanical

Shrink Ratio 2:1
Minimum Shrink Temperature: 90°C (all other colors)

Physical

Material: Polyolefin
Continuous Operating Temperature: -55 to +135°C

Reference Information

Colors: Black and clear (all sizes); White, Red, Blue, and Yellow

Meets Mil-1-23053/5 Class 1 (colors), Class 2 (clear)
UL recognized and CSA certified (colors only)

Wire Management

D

Order No.	Size (Diameter)	Minimum Expanded	Maximum Recovery	Nominal Recovery Wall Thickness	Length m (ft)	Package Quantity	Color	Lead-free
19267-0131	3.175 (0.125)	3.175 (0.125)	1.575 (0.062)	0.508 (0.020)	30.48 (100)	Spool	Red	Yes
19267-0132							Blue	
19267-0133							Clear	
19267-0134							Yellow	
19267-0135	4.750 (0.187)	4.750 (0.187)	2.362 (0.093)	0.508 (0.020)	1.22 (4.00)	25/pkg	Black	
19267-0136							White	
19267-0137							Red	
19267-0138							Blue	
19267-0139							Clear	
19267-0140							Yellow	
19267-0141					0.15 (.500)	200/pkg	Black	
19267-0142							White	
19267-0143							Red	
19267-0144							Blue	
19267-0145							Clear	
19267-0146							Yellow	
19267-0147	0.30 (1.00)	100/pkg	Black					
19267-0148			White					
19267-0149			Red					
19267-0150			Blue					
19267-0151			Clear					
19267-0152			Yellow					
19267-0153			304.8 (1000)	Spool	Black			
19267-0154					White			
19267-0155					Red			
19267-0156					Blue			
19267-0157					Clear			
19267-0158					Yellow			
19267-0159	30.48 (100)	Spool	Black					
19267-0160			White					
19267-0161			Red					
19267-0162			Blue					
19267-0163			Clear					
19267-0164			Yellow					
19267-0165	6.350 (0.250)	6.350 (0.250)	3.175 (0.125)	0.635 (0.025)	1.22 (4.00)	25/pkg	Black	
19267-0166							White	
19267-0167							Red	
19267-0168							Blue	
19267-0169							Clear	
19267-0170							Yellow	
19267-0171					0.15 (.500)	200/pkg	Black	
19267-0172							White	
19267-0173							Red	
19267-0174							Blue	
19267-0175							Clear	
19267-0176							Yellow	
19267-0177	0.30 (1.00)	100/pkg	Black					
19267-0178			White					
19267-0179			Red					
19267-0180			Blue					
19267-0181			Clear					
19267-0182			Yellow					
19267-0183	304.8 (1000)	Spool	Black					
19267-0184			White					
19267-0185			Red					
19267-0186			Blue					
19267-0187			Clear					
19267-0188			Yellow					

Perma-Fit™ Polyolefin Multi-Purpose Heat Shrink Tubing

19267
Thin Wall

Features and Benefits

- High-quality tubing with a wide variety of uses
- Made from flame-retardant Polyolefin
- Excellent physical, chemical, and electrical properties
- Meets industrial and military requirements for highly reliable, general purpose tubing

Reference Information

Colors: Black and clear (all sizes); White, Red, Blue, and Yellow
Meets Mil-1-23053/5 Class 1 (colors), Class 2 (clear)
UL recognized and CSA certified (colors only)

Mechanical

Shrink Ratio 2:1
Minimum Shrink Temperature: 90°C (all other colors)

Physical

Material: Polyolefin
Continuous Operating Temperature: -55 to +135°C

Order No.	Size (Diameter)	Minimum Expanded	Maximum Recovery	Nominal Recovery Wall Thickness	Length m (ft)	Package Quantity	Color	Lead-free
19267-0189	6.350 (0.250)	6.350 (0.250)	3.175 (0.125)	0.025	30.48 (100)	Spool	Black	Yes
19267-0190							White	
19267-0191							Red	
19267-0192							Blue	
19267-0193							Clear	
19267-0194							Yellow	
19267-0195	9.525 (0.375)	9.525 (0.375)	4.750 (0.187)	0.025	1.22 (4.00)	25/pkg	Black	
19267-0196							White	
19267-0197							Red	
19267-0198							Blue	
19267-0199							Clear	
19267-0200							Yellow	
19267-0201					0.15 (.500)	200/pkg	Black	
19267-0202							White	
19267-0203							Red	
19267-0204							Blue	
19267-0205							Clear	
19267-0206							Yellow	
19267-0207					0.30 (1.00)	100/pkg	Black	
19267-0208							White	
19267-0209							Red	
19267-0210							Blue	
19267-0211							Clear	
19267-0212							Yellow	
19267-0213					152.4 (500)	Spool	Black	
19267-0214							White	
19267-0215							Red	
19267-0216							Blue	
19267-0217							Clear	
19267-0218							Yellow	
19267-0219	30.48 (100)	Spool	Black					
19267-0220			White					
19267-0221			Red					
19267-0222			Blue					
19267-0223			Clear					
19267-0224			Yellow					
19267-0225	12.700 (0.500)	12.700 (0.500)	6.350 (0.250)	0.025	1.22 (4.00)	25/pkg	Black	
19267-0226							White	
19267-0227							Red	
19267-0228							Blue	
19267-0229							Clear	
19267-0230							Yellow	
19267-0231					0.15 (.500)	200/pkg	Black	
19267-0232							White	
19267-0233							Red	
19267-0234							Blue	
19267-0235							Clear	
19267-0236							Yellow	
19267-0237	0.30 (1.00)	100/pkg	Black					
19267-0238			White					
19267-0239			Red					
19267-0240			Blue					
19267-0241			Clear					
19267-0242			Yellow					
19267-0243	60.96 (200)	Spool	Black					
19267-0244			White					
19267-0245			Red					
19267-0246							Blue	

D

Wire Management

Perma-Fit™ Polyolefin Multi-Purpose Heat Shrink Tubing

19267
Thin Wall

Features and Benefits

- High-quality tubing with a wide variety of uses
- Made from flame-retardant Polyolefin
- Excellent physical, chemical, and electrical properties
- Meets industrial and military requirements for highly reliable, general purpose tubing

Mechanical

Shrink Ratio 2:1
Minimum Shrink Temperature: 90°C

Physical

Material: Polyolefin
Continuous Operating Temperature: -55 to +135°C

Reference Information

Colors: Black and clear (all sizes); White, Red, Blue, and Yellow
Meets Mil-1-23053/5 Class 1 (colors), Class 2 (clear)
UL recognized and CSA certified (colors only)

D

Wire Management

Order No.	Size (Diameter)	Minimum Expanded	Maximum Recovery	Nominal Recovery Wall Thickness	Length m (ft)	Package Quantity	Color	Lead-free
19267-0247	12.700 (0.500)	12.700 (0.500)	6.350 (0.250)	0.635 (0.025)	60.96 (200)	Spool	Clear	Yes
19267-0248							Yellow	
19267-0249	12.700 (0.500)	12.700 (0.500)	6.350 (0.250)	0.635 (0.025)	30.48 (100)	Spool	Black	
19267-0250							White	
19267-0251							Red	
19267-0252							Blue	
19267-0253							Clear	
19267-0254							Yellow	
19267-0255							Black	
19267-0256	White	1.22 (4.00)	25/pkg	Red				
19267-0257	Blue							
19267-0258	Clear							
19267-0259	Yellow							
19267-0260	Black			0.15 (.500)	200/pkg	White		
19267-0261	Red							
19267-0262	Blue							
19267-0263	Clear							
19267-0264	Yellow							
19267-0265	Black							
19267-0266	White	0.30 (1.00)	100/pkg			Red		
19267-0267	Blue							
19267-0268	Clear							
19267-0269	Yellow							
19267-0270	Black			30.48 (100)	Spool	White		
19267-0271	Red							
19267-0272	Blue							
19267-0273	Clear							
19267-0274	Yellow							
19267-0275	Black							
19267-0276	White	1.22 (4.00)	25/pkg			Red		
19267-0277	Blue							
19267-0278	Clear							
19267-0285	Yellow							
19267-0286	Black			0.15 (.500)	200/pkg	White		
19267-0287	Red							
19267-0288	Blue							
19267-0289	Clear							
19267-0290	Yellow							
19267-0291	Black							
19267-0292	White	0.30 (1.00)	100/pkg			Red		
19267-0293	Blue							
19267-0294	Clear							
19267-0295	Yellow							
19267-0296	Black							
19267-0297	White			30.48 (100)	Spool	Red		
19267-0298	Blue							
19267-0299	Clear							
19267-0300	Yellow							
19267-0301	Black							
19267-0302	White							
19267-0303	Red							
19267-0304	Blue							

Perma-Fit™ Polyolefin Multi-Purpose Heat Shrink Tubing

19267
Thin Wall

Features and Benefits

- High-quality tubing with a wide variety of uses
- Made from flame-retardant Polyolefin
- Excellent physical, chemical, and electrical properties
- Meets industrial and military requirements for highly reliable, general purpose tubing

Reference Information

Colors: Black and clear (all sizes); White, Red, Blue, and Yellow
Meets Mil-1-23053/5 Class 1 (colors), Class 2 (clear)
UL recognized and CSA certified (colors only)

Mechanical

Shrink Ratio 2:1
Minimum Shrink Temperature: 90°C

Physical

Material: Polyolefin
Continuous Operating Temperature: -55 to +135°C

Order No.	Size (Diameter)	Minimum Expanded	Maximum Recovery	Nominal Recovery Wall Thickness	Length m (ft)	Package Quantity	Color	Lead-free		
19267-0305	25.400 (1.000)	25.400 (1.000)	12.700 (0.500)	0.889 (0.035)	30.48 (100)	Spool	Red	Yes		
19267-0306							Blue			
19267-0307							Clear			
19267-0308							Yellow			
19267-0315	38.100 (1.500)	38.100 (1.500)	19.050 (0.750)	1.016 (0.040)	1.22 (4.00)	25/pkg	Black			
19267-0316							White			
19267-0317							Red			
19267-0318							Blue			
19267-0319						Clear				
19267-0320						Yellow				
19267-0321						Black				
19267-0322						White				
19267-0323					Red	200/pkg				
19267-0324					Blue					
19267-0325					Clear					
19267-0326					Yellow					
19267-0327					Black	0.30 (1.00)	100/pkg			
19267-0328					White					
19267-0329					Red					
19267-0330					Blue					
19267-0331					Clear					
19267-0332					Yellow					
19267-0333					Black					
19267-0334					White		Spool			
19267-0335	Red									
19267-0336	Blue									
19267-0337	Clear									
19267-0338	Yellow	50.800 (2.000)	50.800 (2.000)	25.400 (1.000)	1.22 (4.00)	25/pkg	Black			
19267-0345	White									
19267-0346	Red									
19267-0347	Blue									
19267-0348	Clear									
19267-0349	Yellow									
19267-0350	Black					200/pkg				
19267-0351	White									
19267-0352	Red									
19267-0353	Blue									
19267-0354	Clear				0.30 (1.00)	100/pkg				
19267-0355	Yellow									
19267-0356	Black									
19267-0357	White									
19267-0358	Red									
19267-0359	Blue									
19267-0360	Clear									
19267-0361	Yellow									
19267-0362										

D

Wire Management

Perma-Fit™ Polyolefin Multi-Purpose Heat Shrink Tubing

19267
Thin-Wall

Features and Benefits

- High-quality tubing with a wide variety of uses
- Made from flame-retardant Polyolefin
- Excellent physical, chemical, and electrical properties
- Meets industrial and military requirements for highly reliable, general purpose tubing

Reference Information

Colors: Black and clear (all sizes); White, Red, Blue, and Yellow
Meets Mil-1-23053/5 Class 1 (colors), Class 2 (clear)
UL recognized and CSA certified (colors only)

Mechanical

Shrink Ratio 2:1
Minimum Shrink Temperature: 90°C

Physical

Material: Polyolefin
Continuous Operating Temperature: -55 to +135°C

Wire Management

D

Order No.	Size (Diameter)	Minimum Expanded	Maximum Recovery	Nominal Recovery Wall Thickness	Length m (ft)	Package Quantity	Color	Lead-free			
19267-0363	50.800 (2.000)	50.800 (2.000)	25.400 (1.000)	1.143 (0.045)	30.48 (100)	Spool	Black	Yes			
19267-0364							White				
19267-0365							Red				
19267-0366							Blue				
19267-0367							Clear				
19267-0368							Yellow				
19267-0375	76.200 (3.000)	76.200 (3.000)	38.100 (1.500)	1.270 (0.050)	1.22 (4.00)	25/pkg	Black				
19267-0376							White				
19267-0377							Red				
19267-0378							Blue				
19267-0380							Yellow				
19267-0381							Black				
19267-0382					White						
19267-0383					Red						
19267-0384					Blue						
19267-0386					Yellow						
19267-0387					Black						
19267-0388					White						
19267-0389					Red						
19267-0390					Blue						
19267-0392					Yellow						
19267-0393					Black						
19267-0394					White						
19267-0395					Red						
19267-0396					Blue						
19267-0398					Yellow						
19267-0405					101.600 (4.000)	101.600 (4.000)	50.800 (2.000)	1.397 (0.055)	1.22 (4.00)	25/pkg	Black
19267-0411									0.15 (.500)	200/pkg	Black
19267-0417									0.30 (1.00)	100/pkg	Black
19267-0423									15.24 (50)	Spool	Black

Perma-Fit™ Polyolefin Heat Shrink Tubing with Adhesive Melt Liner

19269
Dual Wall

Features and Benefits

- Tough but flexible radiation cross-linked Polyolefin heat shrinkable tubing
- Excellent resistance to vibration, abrasion and corrosion
- Provides superior strain relief
- As it shrinks, the adhesive melt liner melts and flows to seal and encapsulate components or splices contained within

Reference Information

Colors: Black, Clear, Red
Meets Mil-1-23053/4* Class 3 (Black)
Meets UL 224 requirements (jacket only)
UL recognized on black only

Mechanical

Shrink ratio 3:1
Minimum shrink temperature: 120°C

Physical

Material: Polyolefin
Continuous Operating Temperature: -55 to +125°C

Order No.	Size (Diameter)	Minimum Expanded	Maximum Recovery	Nominal Recovery Wall Thickness	Length m (ft)	Package Quantity	Color	Lead-free				
19269-0008	3.175 (0.125)	3.175 (0.125)	1.016 (0.040)	0.965 (0.038)	1.22 (4.00)	25/pkg.	Black	Yes				
19269-0009					0.15 (.500)	200/pkg.	Black					
19269-0010					0.30 (1.00)	100/pkg.	Black					
19269-0155					1.22 (4.00)	25/pkg.	Red					
19269-0013	4.750 (0.187)	4.750 (0.187)	1.524 (0.060)	1.143 (0.045)	1.22 (4.00)	25/pkg.	Black					
19269-0014					0.15 (.500)	200/pkg.	Black					
19269-0238					1.22 (4.00)	25/pkg.	Red					
19269-0015					0.30 (1.00)	100/pkg.	Black					
19269-0043					5.715 (0.225)	1.270 (0.050)	1.194 (0.047)		1.22 (4.00)	25/pkg.	Clear	
19269-0044									0.15 (.500)	200/pkg.	Clear	
19269-0045									0.30 (1.00)	100/pkg.	Clear	
19269-0018									1.22 (4.00)	25/pkg.	Black	
19269-0019	6.350 (0.250)	6.350 (0.250)	2.032 (0.080)	1.194 (0.047)	0.15 (.500)	200/pkg.	Black					
19269-0020					0.30 (1.00)	100/pkg.	Black					
19269-0164					7.442 (0.293)	1.651 (0.065)	1.397 (0.055)		1.22 (4.00)	25/pkg.	Red	
19269-0048									1.22 (4.00)	25/pkg.	Clear	
19269-0049									0.15 (.500)	200/pkg.	Clear	
19269-0050									0.30 (1.00)	100/pkg.	Clear	
19269-0023	9.525 (.375)	9.525 (0.375)	3.048 (0.120)	12.700 (0.050)	1.22 (4.00)	25/pkg.	Black					
19269-0143					0.15 (.500)	200/pkg.	Red					
19269-0024							Black					
19269-0115					0.30 (1.00)	100/pkg.	Red					
19269-0025							Black					
19269-0118					10.846 (0.427)	2.413 (0.095)	1.397 (0.055)		1.22 (4.00)	25/pkg.	Clear	
19269-0053									0.15 (.500)	200/pkg.	Clear	
19269-0054									0.30 (1.00)	100/pkg.	Clear	
19269-0055									12.700 (0.500)	12.700 (0.500)	3.988 (0.157)	1.397 (0.055)
19269-0028					0.15 (.500)	200/pkg.	Red					
19269-0131	Black											
19269-0029	0.30 (1.00)	100/pkg.	Red									
19269-0071			Black									
19269-0030	17.780 (0.700)	4.445 (0.175)	1.397 (0.055)	1.397 (0.055)	1.22 (4.00)	25/pkg.	Clear					
19269-0074					0.15 (.500)	200/pkg.	Clear					
19269-0058					0.30 (1.00)	100/pkg.	Clear					
19269-0059					19.050 (0.750)	19.050 (0.750)	5.842 (0.230)	1.651 (0.065)	1.22 (4.00)	25/pkg.	Black	
19269-0033	0.15 (.500)	200/pkg.	Red									
19269-0142			Black									
19269-0034	0.30 (1.00)	100/pkg.	Red									
19269-0104			Black									
19269-0035	25.400 (1.000)	25.400 (1.000)	8.128 (0.320)	1.905 (0.075)					1.22 (4.00)	25/pkg.	Black	
19269-0110					0.15 (.500)	200/pkg.	Red					
19269-0038							Black					
19269-0138					0.30 (1.00)	100/pkg.	Red					
19269-0039	Black											
19269-0063	0.15 (.500)	200/pkg.	1.905 (0.075)	1.905 (0.075)	Red							
19269-0040					Black							
19269-0067	0.30 (1.00)	100/pkg.	Black									

D

Wire Management

Perma-Fit™ PVC Heat Shrink Tubing

19268
Standard Wall

Features and Benefits

- Heat shrinkable PVC
- Longitudinal shrinkage of approximately 20% allows ripple-free conformance around sharp bends such as appliance handles and bus bars.
- Resists most chemicals and oils as well as sunlight, moisture, and fungus.
- Highly flame retardant

Reference Information

Colors: Black, White, Red, Yellow, and Clear (others available)
Meets UL VW-1 and CSA C22.2

Mechanical

Shrink Ratio: 2:1
Minimum Shrink Temperature: 110°C

D
Wire Management

Order No.	Size (Diameter)	Minimum Expanded	Maximum Recovery	Nominal Recovery Wall Thickness	Length m (ft)	Package Quantity	Color	Lead-free
19268-0033	1.194 (0.047)	1.168 (0.046)	0.584 (0.023)	0.457 (0.018)	304.8 (1000)	Spool	Black	Yes
19268-0034							White	
19268-0035							Red	
19268-0036							Clear	
19268-0037							Yellow	
19268-0038					Black			
19268-0039					White			
19268-0040					Red			
19268-0041					Clear			
19268-0042					Yellow			
19268-0058	1.600 (0.063)	1.600 (0.063)	0.813 (0.032)	0.457 (0.018)	304.8 (1000)	Spool	Black	
19268-0059							White	
19268-0060							Red	
19268-0061							Clear	
19268-0062							Yellow	
19268-0063					Black			
19268-0064					White			
19268-0065					Red			
19268-0066					Clear			
19268-0067					Yellow			
19268-0083	2.388 (0.094)	2.362 (0.093)	1.168 (0.046)	0.508 (0.020)	304.8 (1000)	Spool	Black	
19268-0084							White	
19268-0085							Red	
19268-0086							Clear	
19268-0087							Yellow	
19268-0088					Black			
19268-0089					White			
19268-0090					Red			
19268-0091					Clear			
19268-0092					Yellow			
19268-0108	3.175 (0.125)	3.175 (0.125)	1.600 (0.063)	0.508 (0.020)	304.8 (1000)	Spool	Black	
19268-0109							White	
19268-0110							Red	
19268-0111							Clear	
19268-0112							Yellow	
19268-0113					Black			
19268-0114					White			
19268-0115					Red			
19268-0116					Clear			
19268-0117					Yellow			
19268-0133	4.750 (0.187)	4.750 (0.187)	2.362 (0.093)	0.508 (0.020)	304.8 (1000)	Spool	Black	
19268-0134							White	
19268-0135							Red	
19268-0136							Clear	
19268-0137							Yellow	
19268-0138					Black			
19268-0139					White			
19268-0140					Red			
19268-0141					Clear			
19268-0142					Yellow			
19268-0158	6.350 (0.250)	6.350 (0.250)	3.175 (0.125)	0.635 (0.025)	304.8 (1000)	Spool	Black	
19268-0159							White	
19268-0160							Red	
19268-0161							Clear	
19268-0162							Yellow	
19268-0163					Black			
19268-0164					White			
19268-0165					Red			
19268-0166					Clear			
19268-0167					Yellow			
19268-0208	9.525 (0.375)	9.525 (0.375)	4.750 (0.187)	0.635 (0.025)	60.96 (200)	Spool	Black	
19268-0209							White	

Perma-Fit™ PVC Heat Shrink Tubing 19268 Standard Wall

Features and Benefits

- Heat shrinkable PVC
- Longitudinal shrinkage of approximately 20% allows ripple-free conformance around sharp bends such as appliance handles and bus bars.
- Resists most chemicals and oils as well as sunlight, moisture, and fungus.
- Highly flame retardant

Reference Information

Colors: Black, White, Red, Yellow, and Clear (others available)
Meets UL VW-1 and CSA C22.2

Mechanical

Shrink Ratio: 2:1
Minimum Shrink Temperature: 110°C

Order No.	Size (Diameter)	Minimum Expanded	Maximum Recovery	Nominal Recovery Wall Thickness	Length m (ft)	Package Quantity	Color	Lead-free			
19268-0210	9.525 (0.375)	9.525 (0.375)	4.750 (0.187)	0.635 (0.025)	60.96 (200)	Spool	Red	Yes			
19268-0211							Clear				
19268-0212							Yellow				
19268-0213							Black				
19268-0214							White				
19268-0215							Red				
19268-0216							Clear				
19268-0217	Yellow										
19268-0233	12.700 (0.500)	12.700 (0.500)	6.350 (0.250)		60.96 (200)		Black				
19268-0234							White				
19268-0235							Red				
19268-0236							Clear				
19268-0237							Yellow				
19268-0238							Black				
19268-0239				White							
19268-0240	Red										
19268-0241	Clear										
19268-0242	Yellow										
19268-0258	15.875 (0.625)	15.875 (0.625)	7.950 (0.313)	60.96 (200)	Black						
19268-0259					White						
19268-0260					Red						
19268-0261					Clear						
19268-0262					Yellow						
19268-0263					Black						
19268-0264					White						
19268-0265	Red										
19268-0266	Clear										
19268-0267	Yellow										
19268-0283	19.050 (0.750)	19.050 (0.750)	9.525 (0.375)	0.035	30.48 (100)	Black					
19268-0284						White					
19268-0285						Red					
19268-0286						Clear					
19268-0287						Yellow					
19268-0308						25.400 (1.000)	25.400 (1.000)		12.700 (0.500)	30.48 (100)	Black
19268-0309											White
19268-0310	Red										
19268-0311	Clear										
19268-0312	Yellow										
19268-0333	31.750 (1.250)	31.750 (1.250)	16.002 (0.630)		0.889 (0.035)						Black
19268-0334											White
19268-0335						Red					
19268-0336						Clear					
19268-0337				Yellow							
19268-0358				38.100 (1.500)		38.100 (1.500)	19.050 (0.750)	1.016 (0.040)	Black		
19268-0359									White		
19268-0360	Red										
19268-0361	Clear										
19268-0362	Yellow										
19268-0383	50.800 (2.000)	50.800 (2.000)	25.400 (1.000)		1.143 (0.045)				Black		
19268-0384									White		
19268-0385				Red							
19268-0386				Clear							
19268-0387				Yellow							
19268-0408				76.200 (3.000)		76.200 (3.000)	38.100 (1.500)	1.270 (0.050)	Black		
19268-0409									White		
19268-0410	Red										
19268-0411	Clear										
19268-0412	Yellow										
19268-0433	101.600 (4.000)	101.600 (4.000)	50.800 (2.000)		1.397 (0.055)				Black		
19268-0434									White		
19268-0435				Red							
19268-0436				Clear							
19268-0437				Yellow							

D

Wire Management

Perma-Fit™ Battery Cable Heat Shrink Tubing

19270
Heavy Wall

Features and Benefits

- Heavy wall tubing (dual wall)
- Thermally stabilized and modified Polyolefin heat shrinkable tubing made especially for battery terminals and cable
- Provides a more positive sealing method which offers greater protection under the most adverse environmental conditions
- Seals may be made over lead, steel, copper, aluminum, and all standard plastic and elastomeric insulating materials
- Can withstand submersible and direct burial installation
- Thick-wall insulation and abrasion protection

Reference Information

Colors: Red, black
Meets Mil-1-23053/15 Class 1
Meets UL 486 D and CSA C22.2 No.198.2

Mechanical

Shrink Ratio 3:1
Shrink Temperature: 120°C

Physical

Material: Polyolefin
Continuous Operating Temperature: 55°C to 110°C
Rated 600V, 90°C continuous use

Wire Management

D

Order No.	Size (Diameter)	Minimum Expanded	Maximum Recovery	Nominal Recovery Wall Thickness	Length m (ft)	Package Quantity	Color	Recommended Cable Range for 600V Cable	Lead-free
19270-0008	10.160 (0.400)	10.160 (0.400)	3.810 (0.150)	1.524 (0.060)	1.22 (4.00)	40/pkg.	Black	10-14 AWG	
19270-0009					.15 (.500)	200/pkg.	Black		
19270-0010					.30 (1.00)	100/pkg.	Black		
19270-0013					1.22 (4.00)	40/pkg.	Red		
19270-0014					.15 (.500)	200/pkg.	Red		
19270-0015					.30 (1.00)	100/pkg.	Red		
19270-0018	19.050 (0.750)	19.050 (0.750)	5.588 (0.220)	2.413 (0.095)	1.22 (4.00)	25/pkg.	Black	2-6 AWG	
19270-0019					.15 (.500)	200/pkg.	Black		
19270-0020					.30 (1.00)	100/pkg.	Black		
19270-0023					1.22 (4.00)	25/pkg.	Red		
19270-0024					.15 (.500)	200/pkg.	Red		
19270-0025					.30 (1.00)	100/pkg.	Red		
19270-0028	27.940 (1.100)	27.940 (1.100)	9.525 (0.375)	3.048 (0.120)	1.22 (4.00)	25/pkg.	Black	1-3/0 AWG	
19270-0029					.15 (.500)	200/pkg.	Black		
19270-0030					.30 (1.00)	100/pkg.	Black		
19270-0033					1.22 (4.00)	25/pkg.	Red		
19270-0034					.15 (.500)	200/pkg.	Red		
19270-0035					.30 (1.00)	100/pkg.	Red		
19270-0038	38.100 (1.500)	38.100 (1.500)	12.700 (0.500)	3.556 (0.140)	1.22 (4.00)	25/pkg.	Black	2/0 AWG-350 MCM	Yes
19270-0039					.15 (.500)	200/pkg.	Black		
19270-0040					.30 (1.00)	100/pkg.	Black		
19270-0043					1.22 (4.00)	25/pkg.	Red		
19270-0044					.15 (.500)	200/pkg.	Red		
19270-0045					.30 (1.00)	100/pkg.	Red		
19270-0048	50.800 (2.000)	50.800 (2.000)	19.050 (0.750)	3.937 (0.155)	1.22 (4.00)	25/pkg.	Black	250-500 MCM	
19270-0049					.15 (.500)	200/pkg.	Black		
19270-0050					.30 (1.00)	100/pkg.	Black		
19270-0053					1.22 (4.00)	25/pkg.	Red		
19270-0054					.15 (.500)	200/pkg.	Red		
19270-0055					.30 (1.00)	100/pkg.	Red		
19270-0058	89.916 (3.540)	89.916 (3.540)	29.972 (1.180)	3.937 (0.155)	1.22 (4.00)	25/pkg.	Black	900-1500 MCM	
19270-0059					.15 (.500)	200/pkg.	Black		
19270-0060					.30 (1.00)	100/pkg.	Black		
19270-0063					1.22 (4.00)	25/pkg.	Red		
19270-0064					.15 (.500)	200/pkg.	Red		
19270-0065					.30 (1.00)	100/pkg.	Red		
19270-0068	119.888 (4.720)	119.888 (4.720)	39.878 (1.570)	18.034 (0.170)	1.22 (4.00)	25/pkg.	Black	1500-2500 MCM	
19270-0069					.15 (.500)	200/pkg.	Black		
19270-0070					.30 (1.00)	100/pkg.	Black		
19270-0073					1.22 (4.00)	25/pkg.	Red		
19270-0074					.15 (.500)	200/pkg.	Red		
19270-0075					.30 (1.00)	100/pkg.	Red		

Pluggable (2-piece) Eurostyle™ PCB Terminal Blocks	E-2 to E-32
Fixed Mount (1-Piece) Eurostyle™ PCB Terminal Blocks	E-33 to E-49
Two-Screw Panel Mount Terminal Strips (“Eurostrips”)	E-50 to E-51
Single Row Barrier Terminal Strips	E-52 to E-72
Double Row Barrier Terminal Strips	E-72 to E-73
Barrier Terminal Strips Accessories	E-74

3.50mm (.138") Pitch ESE Pluggable PCB Terminal Blocks

39503 Vertical Plug

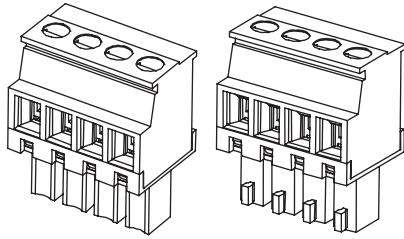

Rear Wire Entry

Front Wire Entry

Features and Benefits

- Smallest pitch Eurostyle terminal block provides higher density
- Two optional styles of imprinting make identifying, testing and wiring easier in the field

Reference Information

Packaging: Tray
UL File No.: E48521
Mates With: 39501 and 39502
Designed In: Millimeters

Electrical

Voltage: 300V
Current: 8.0A
Insulation Resistance: 500 Megohms min.

Mechanical

Recommended Tightening Torque: 0.23Nm (2 in.-lb)

Physical

Housing: Polyamide 6/6, black
Terminal: Phosphor Bronze
Cage Clamp: Brass
Screw: Steel, M2
Plating: Terminal Area—Tin
Cage Clamp—Nickel
Screw—Zinc
Wire Range: 16 to 30 AWG
Operating Temperature: -40°C to +115°C

Circuits	Order No.		Lead-free
	Front Wire Entry	Rear Wire Entry	
2	39503-3002	39503-2002	Yes
3	39503-3003	39503-2003	
4	39503-3004	39503-2004	
5	39503-3005	39503-2005	
6	39503-3006	39503-2006	
7	39503-3007	39503-2007	
8	39503-3008	39503-2008	
9	39503-3009	39503-2009	
10	39503-3010	39503-2010	
11	39503-3011	39503-2011	

Note: Standard 10A (1, 2, 3...) and reverse 11A (3, 2, 1...) imprinting available.
Please refer to sales drawing for additional order numbers (available on the web).

Circuits	Order No.		Lead-free
	Front Wire Entry	Rear Wire Entry	
12	39503-3012	39503-2012	Yes
13	39503-3013	39503-2013	
14	39503-3014	39503-2014	
15	39503-3015	39503-2015	
16	39503-3016	39503-2016	
17	39503-3017	39503-2017	
18	39503-3018	39503-2018	
19	39503-3019	39503-2019	
20	39503-3020	39503-2020	

3.50mm (.138") Pitch ESE Pluggable PCB Terminal Blocks

39500 Horizontal Plug

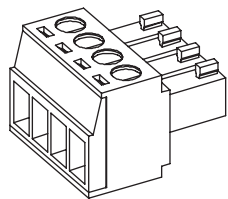

Features and Benefits

- Smallest pitch Eurostyle terminal block provides higher density
- Two optional styles of imprinting make identifying, testing and wiring easier in the field
- Polarized to prevent mismatching

Reference Information

Packaging: Tray
UL File No.: E48521
Mates With: 39501 and 39502
Designed In: Millimeters

Electrical

Voltage: 300V
Current: 8.0A
Insulation Resistance: 500 Megohms min.

Mechanical

Recommended Tightening Torque: 0.23Nm (2 in.-lb)

Physical

Housing: Polyamide 6/6, black
Terminal: Phosphor Bronze
Cage Clamp: Brass
Screw: Steel, M2
Plating: Terminal Area—Tin
Cage Clamp—Nickel
Screw—Zinc
Wire Range: 16 to 30 AWG
Operating Temperature: -40°C to +115°C

Circuits	Order No.	Lead-free
2	39500-0002	Yes
3	39500-0003	
4	39500-0004	
5	39500-0005	
6	39500-0006	
7	39500-0007	
8	39500-0008	

Circuits	Order No.	Lead-free
9	39500-0009	Yes
10	39500-0010	
11	39500-0011	
12	39500-0012	
13	39500-0013	
14	39500-0014	
15	39500-0015	

Circuits	Order No.	Lead-free
16	39500-0016	Yes
17	39500-0017	
18	39500-0018	
19	39500-0019	
20	39500-0020	

Note: Standard 10A (1, 2, 3...) and reverse 11A (3, 2, 1...) imprinting available.
Please refer to sales drawing for additional order numbers (available on the web).

3.50mm (.138") Pitch ESE Pluggable PCB Terminal Blocks

39501

Vertical PCB Header

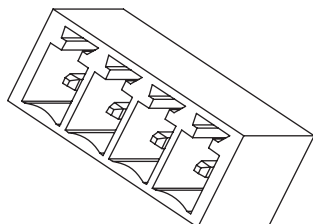

Features and Benefits

- Smallest footprint available in Eurostyle terminal blocks conserves PCB real estate and provides higher density
- Two optional styles of imprinting make identifying, testing and wiring easier in the field

Reference Information

Packaging: Tray
UL File No.: E48521
Mates With: 39500 and 39503
Designed In: Millimeters

Electrical

Voltage: 300V
Current: 8.0A
Insulation Resistance: 500 Megohms min.

Physical

Housing: Polyamide 6/6, black
Terminal: Brass
Plating: Terminal Area—Tin
Operating Temperature: -40°C to +115°C

Circuits	Order No.	Lead-free
2	39501-1002	Yes
3	39501-1003	
4	39501-1004	
5	39501-1005	
6	39501-1006	
7	39501-1007	
8	39501-1008	

Circuits	Order No.	Lead-free
9	39501-1009	Yes
10	39501-1010	
11	39501-1011	
12	39501-1012	
13	39501-1013	
14	39501-1014	
15	39501-1015	

Circuits	Order No.	Lead-free
16	39501-1016	Yes
17	39501-1017	
18	39501-1018	
19	39501-1019	
20	39501-1020	

Note: Standard 10A (1, 2, 3...) and reverse 11A (3, 2, 1...) imprinting available. Please refer to sales drawing for additional order numbers (available on the web).

3.50mm (.138") Pitch ESE Pluggable PCB Terminal Blocks

39502

Horizontal PCB Header

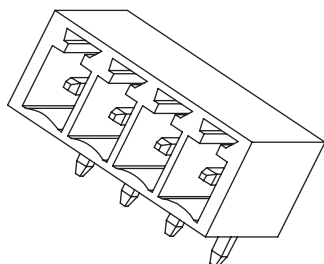

Features and Benefits

- Smallest footprint available in Eurostyle terminal blocks conserves PCB real estate and provides higher density
- Two optional styles of imprinting make identifying, testing and wiring easier in the field

Reference Information

Packaging: Tray
UL File No.: E48521
Mates With: 39500 and 39503
Designed In: Millimeters

Electrical

Voltage: 300V
Current: 8.0A
Insulation Resistance: 500 Megohms min.

Physical

Housing: Polyamide 6/6, black
Terminal: Brass
Plating: Terminal Area—Tin
Operating Temperature: -40°C to +115°C

Circuits	Order No.	Lead-free
2	39502-1002	Yes
3	39502-1003	
4	39502-1004	
5	39502-1005	
6	39502-1006	
7	39502-1007	
8	39502-1008	

Circuits	Order No.	Lead-free
9	39502-1009	Yes
10	39502-1010	
11	39502-1011	
12	39502-1012	
13	39502-1013	
14	39502-1014	
15	39502-1015	

Circuits	Order No.	Lead-free
16	39502-1016	Yes
17	39502-1017	
18	39502-1018	
19	39502-1019	
20	39502-1020	

Note: Standard 10A (1, 2, 3...) and reverse 11A (3, 2, 1...) imprinting available. Please refer to sales drawing for additional order numbers (available on the web).

3.50mm (.138") Pitch ESE Pluggable PCB Terminal Blocks

39507 Vertical Plug with Retention Screws

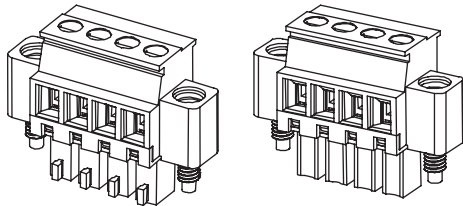

Front Wire Entry

Rear Wire Entry

Features and Benefits

- Smallest pitch Eurostyle terminal block provides higher density
- Two optional styles of imprinting make identifying, testing and wiring easier in the field
- Polarized to prevent mismatching

Reference Information

Packaging: Tray
UL File No.: E48521
Mates With: 39505 and 39506
Designed In: Millimeters

Electrical

Voltage: 300V
Current: 8.0A
Insulation Resistance: 500 Megohms min.

Mechanical

Recommended Tightening Torque: 0.23Nm (2 in.-lb)

Physical

Housing: Polyamide 6/6, black
Terminal: Phosphor Bronze
Cage Clamp: Brass
Screw: Steel, M2
Plating: Terminal Area—Tin
Cage Clamp—Nickel
Screw—Zinc
Wire Range: 16 to 30 AWG
Operating Temperature: -40°C to +115°C

Circuits	Order No.		Lead-free
	Front Wire Entry	Rear Wire Entry	
2	39507-3002	39507-2002	Yes
3	39507-3003	39507-2003	
4	39507-3004	39507-2004	
5	39507-3005	39507-2005	
6	39507-3006	39507-2006	
7	39507-3007	39507-2007	
8	39507-3008	39507-2008	
9	39507-3009	39507-2009	
10	39507-3010	39507-2010	
11	39507-3011	39507-2011	

Note: Standard 10A (1, 2, 3...) and reverse 11A (3, 2, 1...) imprinting available.
Please refer to sales drawing for additional order numbers (available on the web).

Circuits	Order No.		Lead-free
	Front Wire Entry	Rear Wire Entry	
12	39507-3012	39507-2012	Yes
13	39507-3013	39507-2013	
14	39507-3014	39507-2014	
15	39507-3015	39507-2015	
16	39507-3016	39507-2016	
17	39507-3017	39507-2017	
18	39507-3018	39507-2018	
19	39507-3019	39507-2019	
20	39507-3020	39507-2020	

3.50mm (.138") Pitch ESE Pluggable PCB Terminal Blocks

39504 Horizontal Plug with Retention Screws

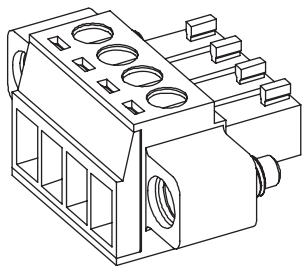

Features and Benefits

- Smallest pitch Eurostyle terminal block provides higher density
- Two optional styles of imprinting make identifying, testing and wiring easier in the field
- Polarized to prevent mismatching

Reference Information

Packaging: Tray
UL File No.: E48521
Mates With: 39505 and 39506
Designed In: Millimeters

Electrical

Voltage: 300V
Current: 8.0A
Insulation Resistance: 500 Megohms min.

Mechanical

Recommended Tightening Torque: 0.23Nm (2 in.-lb)

Physical

Housing: Polyamide 6/6, black
Terminal: Phosphor Bronze
Cage Clamp: Brass
Screw: Steel, M2
Plating: Terminal Area—Tin
Cage Clamp—Nickel
Screw—Zinc
Wire Range: 16 to 30 AWG
Operating Temperature: -40°C to +115°C

Circuits	Order No.	Lead-free
2	39504-0002	Yes
3	39504-0003	
4	39504-0004	
5	39504-0005	
6	39504-0006	
7	39504-0007	
8	39504-0008	

Circuits	Order No.	Lead-free
9	39504-0009	Yes
10	39504-0010	
11	39504-0011	
12	39504-0012	
13	39504-0013	
14	39504-0014	
15	39504-0015	

Circuits	Order No.	Lead-free
16	39504-0016	Yes
17	39504-0017	
18	39504-0018	
19	39504-0019	
20	39504-0020	

Note: Standard 10A (1, 2, 3...) and reverse 11A (3, 2, 1...) imprinting available.
Please refer to sales drawing for additional order numbers (available on the web).

3.50mm (.138") Pitch ESE Pluggable PCB Terminal Blocks

39505

Vertical PCB Header with Threaded Retention Inserts

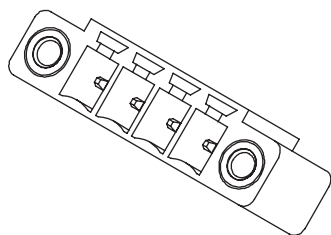

Features and Benefits

- Smallest footprint available in Eurostyle terminal blocks conserves PCB real estate and provides higher density
- Two optional styles of imprinting make identifying, testing and wiring easier in the field

Reference Information

Packaging: Tray
UL File No.: E48521
Mates With: 39504 and 39507
Designed In: Millimeters

Electrical

Voltage: 300V
Current: 8.0A
Insulation Resistance: 500 Megohms min.

Physical

Housing: Polyamide 6/6, black
Terminal: Brass
Plating: Terminal Area—Tin
Operating Temperature: -40°C to +115°C

Circuits	Order No	Lead-free
2	39505-1002	Yes
3	39505-1003	
4	39505-1004	
5	39505-1005	
6	39505-1006	
7	39505-1007	
8	39505-1008	

Circuits	Order No	Lead-free
9	39505-1009	Yes
10	39505-1010	
11	39505-1011	
12	39505-1012	
13	39505-1013	
14	39505-1014	
15	39505-1015	

Circuits	Order No	Lead-free
16	39505-1016	Yes
17	39505-1017	
18	39505-1018	
19	39505-1019	
20	39505-1020	

Note: Standard 10A (1, 2, 3...) and reverse 11A (3, 2, 1...) imprinting available. Please refer to sales drawing for additional order numbers (available on the web).

3.50mm (.138") Pitch ESE Pluggable PCB Terminal Blocks

39506

Horizontal PCB Header with Threaded Retention Inserts

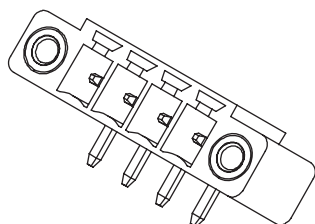

Features and Benefits

- Smallest footprint available in Eurostyle terminal blocks conserves PCB real estate and provides higher density
- Two optional styles of imprinting make identifying, testing and wiring easier in the field

Reference Information

Packaging: Tray
UL File No.: E48521
Mates With: 39504 and 39507
Designed In: Millimeters

Electrical

Voltage: 300V
Current: 8.0A
Insulation Resistance: 500 Megohms min.

Physical

Housing: Polyamide 6/6, black
Terminal: Brass
Plating: Terminal Area—Tin
Operating Temperature: -40°C to +115°C

Circuits	Order No.	Lead-free
2	39506-1002	Yes
3	39506-1003	
4	39506-1004	
5	39506-1005	
6	39506-1006	
7	39506-1007	
8	39506-1008	

Circuits	Order No.	Lead-free
9	39506-1009	Yes
10	39506-1010	
11	39506-1011	
12	39506-1012	
13	39506-1013	
14	39506-1014	
15	39506-1015	

Circuits	Order No.	Lead-free
16	39506-1016	Yes
17	39506-1017	
18	39506-1018	
19	39506-1019	
20	39506-1020	

Note: Standard 10A (1, 2, 3...) and reverse 11A (3, 2, 1...) imprinting available. Please refer to sales drawing for additional order numbers (available on the web).

3.81 mm (.150") Pitch Beau™ EuroMate™ Pluggable PCB Terminal Blocks

39930

Vertical Plug Rear and Front Wire Entry

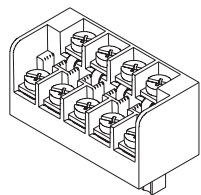

Features and Benefits

- Pluggable barrier strip combines the benefits of pluggable Eurostyle design and the flexibility of barrier terminal strips
- Wiring terminals are staggered and offset vertically to facilitate easier wiring access
- Rear barrier prevents over-insertion of wire into terminal block
- Single row of female contacts interface with industry standard Eurostyle PCB headers, which produces twice the pitch at the wiring terminal

Reference Information

Packaging: Tray
UL File: E48521
Flammability: UL 94V-0
Mates With: Most industry standard
3.81 mm (.150") pitch PCB headers

Electrical

Voltage: 300V
Current: 12.0A
Insulation Resistance: 3000 Megohms min.

Mechanical

Recommended Tightening Torque: 0.79Nm (7.0 in.-lb.)

Physical

Housing: Polyamide 6/6, black
Terminal: Copper
Screw with Square Washer: Steel, M3
Plating: Terminal—Tin
Screw—Zinc with clear Chromate
Wire Range: 14 to 22 AWG
Operating Temperature: -40°C to +120°C

Circuits	Order No.		Lead-free
	Rear Wire Entry	Front Wire Entry	
3	39930-0203	39930-0303	Yes
4	39930-0204	39930-0304	
5	39930-0205	39930-0305	
6	39930-0206	39930-0306	
7	39930-0207	39930-0307	
8	39930-0208	39930-0308	
9	39930-0209	39930-0309	
10	39930-0210	39930-0310	
11	39930-0211	39930-0311	
12	39930-0212	39930-0312	

Note: Gold plating available. Contact your local Molex sales representative or distributor for order number.

Circuits	Order No.		Lead-free
	Rear Wire Entry	Front Wire Entry	
13	39930-0213	39930-0313	Yes
14	39930-0214	39930-0314	
15	39930-0215	39930-0315	
16	39930-0216	39930-0316	
17	39930-0217	39930-0317	
18	39930-0218	39930-0318	
19	39930-0219	39930-0319	
20	39930-0220	39930-0320	
21	39930-0221	39930-0321	

3.81 mm (.150") Pitch Beau™ EuroMate™ Pluggable PCB Terminal Blocks

39930

Vertical Plug with Mounting Ends Rear and Front Wire Entry

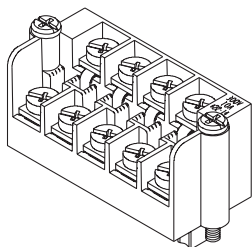

Features and Benefits

- Pluggable barrier strip combines the benefits of pluggable Eurostyle design and the flexibility of barrier terminal strips
- Wiring terminals are staggered and offset vertically to facilitate easier wiring access
- Rear barrier prevents over-insertion of wire into terminal block
- Single row of female contacts interface with industry standard Eurostyle PCB headers, which produces twice the pitch at the wiring terminal

Reference Information

Packaging: Tray
UL File No.: E48521
Flammability: UL 94V-0
Mates With: Most industry standard
3.81 mm (.150") pitch PCB headers

Electrical

Voltage: 300V
Current: 12.0A
Insulation Resistance: 3000 Megohms min.

Mechanical

Recommended Tightening Torque: 0.79Nm (7.0 in.-lb.)

Physical

Housing: Polyamide 6/6, black
Terminal: Bronze
Screw With Square Washer: Steel, M3
Plating: Terminal—Tin
Screw—Zinc with yellow chromate
Wire Range: 14 to 22 AWG
Operating Temperature: -40°C to +120°C

Circuits	Order No.		Lead-free
	Rear Wire Entry	Front Wire Entry	
3	39930-0403	39930-0503	Yes
4	39930-0404	39930-0504	
5	39930-0405	39930-0505	
6	39930-0406	39930-0506	
7	39930-0407	39930-0507	
8	39930-0408	39930-0508	
9	39930-0409	39930-0509	
10	39930-0410	39930-0510	
11	39930-0411	39930-0511	
12	39930-0412	39930-0512	

Note: Gold plating available. Contact your local Molex sales representative or distributor for order number.

Circuits	Order No.		Lead-free
	Rear Wire Entry	Front Wire Entry	
13	39930-0413	39930-0513	Yes
14	39930-0414	39930-0514	
15	39930-0415	39930-0515	
16	39930-0416	39930-0516	
17	39930-0417	39930-0517	
18	39930-0418	39930-0518	
19	39930-0419	39930-0519	
20	39930-0420	39930-0520	
21	39930-0421	39930-0521	

3.81 mm (.150") Pitch ESE Pluggable PCB Terminal Blocks

39513 Vertical Plug

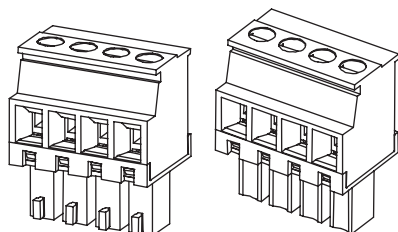

Front Wire Entry

Rear Wire Entry

Features and Benefits

- Two optional styles of imprinting make identifying, testing and wiring easier in the field
- Polarized to prevent mismatching

Reference Information

Packaging: Tray
UL File No.: E48521
Mates With: 39511 and 39512
Designed In: Inches

Electrical

Voltage: 300V
Current: 8.0A
Insulation Resistance: 500 Megohms min.

Mechanical

Recommended Tightening Torque: 0.23Nm (2 in.-lb)

Physical

Housing: Polyamide 6/6, black
Terminal: Phosphor Bronze
Cage Clamp: Brass
Screw: Steel, M2
Plating: Terminal Area—Tin
Cage Clamp—Nickel
Screw—Zinc
Wire Range: 16 to 30 AWG
Operating Temperature: -40 to +115°C

Circuits	Order No.		Lead-free
	Front Wire Entry	Rear Wire Entry	
2	39513-3002	39513-2002	Yes
3	39513-3003	39513-2003	
4	39513-3004	39513-2004	
5	39513-3005	39513-2005	
6	39513-3006	39513-2006	
7	39513-3007	39513-2007	
8	39513-3008	39513-2008	
9	39513-3009	39513-2009	
10	39513-3010	39513-2010	
11	39513-3011	39513-2011	

Note: Standard 10A (1, 2, 3...) and reverse 11A (3, 2, 1...) imprinting available.
Please refer to sales drawing for additional order numbers (available on the web).

Circuits	Order No.		Lead-free
	Front Wire Entry	Rear Wire Entry	
12	39513-3012	39513-2012	Yes
13	39513-3013	39513-2013	
14	39513-3014	39513-2014	
15	39513-3015	39513-2015	
16	39513-3016	39513-2016	
17	39513-3017	39513-2017	
18	39513-3018	39513-2018	
19	39513-3019	39513-2019	
20	39513-3020	39513-2020	

3.81 mm (.150") Pitch ESE Pluggable PCB Terminal Blocks

39510 Horizontal Plug

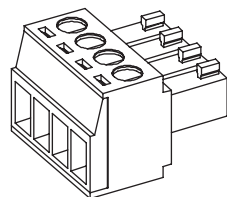

Features and Benefits

- Two optional styles of imprinting make identifying, testing and wiring easier in the field
- Polarized to prevent mismatching

Reference Information

Packaging: Tray
UL File No.: E48521
Mates With: 39511 and 39512
Designed In: Millimeters

Electrical

Voltage: 300V
Current: 8.0A
Insulation Resistance: 500 Megohms min.

Mechanical

Recommended Tightening Torque: 0.23Nm (2 in.-lb)

Physical

Housing: Polyamide 6/6, black
Terminal: Phosphor Bronze
Cage Clamp: Brass
Screw: Steel, M2
Plating: Terminal Area—Tin
Cage Clamp—Nickel
Screw—Zinc
Wire Range: 16 to 30 AWG
Operating Temperature: -40°C to +115°C

Circuits	Order No.	Lead-free
2	39510-0002	Yes
3	39510-0003	
4	39510-0004	
5	39510-0005	
6	39510-0006	
7	39510-0007	
8	39510-0008	

Circuits	Order No.	Lead-free
9	39510-0009	Yes
10	39510-0010	
11	39510-0011	
12	39510-0012	
13	39510-0013	
14	39510-0014	
15	39510-0015	

Circuits	Order No.	Lead-free
16	39510-0016	Yes
17	39510-0017	
18	39510-0018	
19	39510-0019	
20	39510-0020	

Note: Standard 10A (1, 2, 3...) and reverse 11A (3, 2, 1...) imprinting available.
Please refer to sales drawing for additional order numbers (available on the web).

3.81mm (.150") Pitch ESE Pluggable PCB Terminal Blocks

39511 Vertical PCB Header

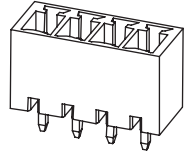

Features and Benefits

- Two optional styles of imprinting make identifying, testing and wiring easier in the field
- Polarized to prevent mismatching

Reference Information

Packaging: Tray
UL File No.: E48521
Mates With: 39510 and 39513
Designed In: Inches

Electrical

Voltage: 300V
Current: 8.0A
Insulation Resistance: 500 Megohms min.

Physical

Housing: Polyamide 6/6, black
Terminal: Brass
Plating: Terminal—Tin
Operating Temperature: -40 to +115°C

Circuits	Order No.	Lead-free
2	39511-1002	Yes
3	39511-1003	
4	39511-1004	
5	39511-1005	
6	39511-1006	
7	39511-1007	
8	39511-1008	

Circuits	Order No.	Lead-free
9	39511-1009	Yes
10	39511-1010	
11	39511-1011	
12	39511-1012	
13	39511-1013	
14	39511-1014	
15	39511-1015	

Circuits	Order No.	Lead-free
16	39511-1016	Yes
17	39511-1017	
18	39511-1018	
19	39511-1019	
20	39511-1020	

Note: Standard 10A (1, 2, 3...) and reverse 11A (3, 2, 1...) imprinting available. Please refer to sales drawing for additional order numbers (available on the web).

3.81mm (.150") Pitch ESE Pluggable PCB Terminal Blocks

39512 Horizontal PCB Header

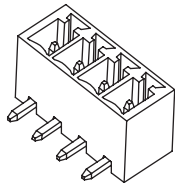

Features and Benefits

- Two optional styles of imprinting make identifying, testing and wiring easier in the field
- Polarized to prevent mismatching

Reference Information

Packaging: Tray
UL File No.: E48521
Mates With: 39510 and 39513
Designed In: Inches

Electrical

Voltage: 300V
Current: 8.0A
Insulation Resistance: 500 Megohms min.

Physical

Housing: Polyamide 6/6, black
Terminal: Brass
Plating: Terminal Area—Tin
Operating Temperature: -40 to +115°C

Circuits	Order No.	Lead-free
2	39512-1002	Yes
3	39512-1003	
4	39512-1004	
5	39512-1005	
6	39512-1006	
7	39512-1007	
8	39512-1008	

Circuits	Order No.	Lead-free
9	39512-1009	Yes
10	39512-1010	
11	39512-1011	
12	39512-1012	
13	39512-1013	
14	39512-1014	
15	39512-1015	

Circuits	Order No.	Lead-free
16	39512-1016	Yes
17	39512-1017	
18	39512-1018	
19	39512-1019	
20	39512-1020	

Note: Standard 10A (1, 2, 3...) and reverse 11A (3, 2, 1...) imprinting available. Please refer to sales drawing for additional order numbers (available on the web).

3.81 mm (.150") Pitch ESE Pluggable PCB Terminal Blocks

39517 Vertical Plug with Retention Screws

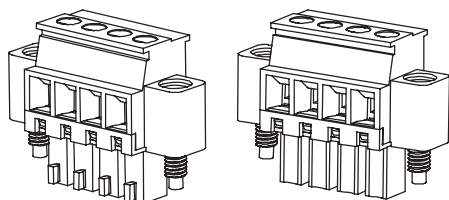

Front Wire Entry

Rear Wire Entry

Features and Benefits

- Two optional styles of imprinting make identifying, testing and wiring easier in the field
- Polarized to prevent mismatching

Reference Information

Packaging: Tray
UL File No.: E48521
Mates With:
39515 and 39516
Designed In: Inches

Electrical

Voltage: 300V
Current: 8.0A
Insulation Resistance: 500 Megohms min.

Mechanical

Recommended Tightening Torque: 0.23Nm (2 in.-lb)

Physical

Housing: Polyamide 6/6, black
Terminal: Phosphor Bronze
Cage Clamp: Brass
Screw: Steel, M2
Plating: Terminal Area—Tin
Cage Clamp—Nickel
Screw—Zinc
Wire Range: 16 to 30 AWG
Operating Temperature: -40 to +115°C

Circuits	Order No.		Lead-free
	Front Wire Entry	Rear Wire Entry	
2	39517-3002	39517-2002	Yes
3	39517-3003	39517-2003	
4	39517-3004	39517-2004	
5	39517-3005	39517-2005	
6	39517-3006	39517-2006	
7	39517-3007	39517-2007	
8	39517-3008	39517-2008	
9	39517-3009	39517-2009	
10	39517-3010	39517-2010	
11	39517-3011	39517-2011	

Circuits	Order No.		Lead-free
	Front Wire Entry	Rear Wire Entry	
12	39517-3012	39517-2012	Yes
13	39517-3013	39517-2013	
14	39517-3014	39517-2014	
15	39517-3015	39517-2015	
16	39517-3016	39517-2016	
17	39517-3017	39517-2017	
18	39517-3018	39517-2018	
19	39517-3019	39517-2019	
20	39517-3020	39517-2020	

Note: Standard 10A (1, 2, 3...) and reverse 11A (3, 2, 1...) imprinting available.
Please refer to sales drawing for additional order numbers (available on the web).

3.81 mm (.150") Pitch ESE Pluggable PCB Terminal Blocks

39514 Horizontal Plug with Retention Screws

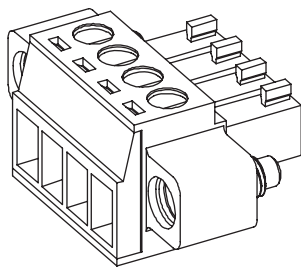

Features and Benefits

- Two optional styles of imprinting make identifying, testing and wiring easier in the field
- Polarized to prevent mismatching

Reference Information

Packaging: Tray
UL File No.: E48521
Mates With: 39515 and 39516
Designed In: Inches

Electrical

Voltage: 300V
Current: 8.0A
Insulation Resistance: 500 Megohms min.

Mechanical

Recommended Tightening Torque: 0.23Nm (2 in.-lb)

Physical

Housing: Polyamide 6/6, black
Terminal: Phosphor Bronze
Cage Clamp: Brass
Screw: Steel, M2
Plating: Terminal Area—Tin
Cage Clamp—Nickel
Screw—Zinc
Wire Range: 16 to 30 AWG
Operating Temperature: -40 to +115°C

Circuits	Order No.	Lead-free
2	39514-0002	Yes
3	39514-0003	
4	39514-0004	
5	39514-0005	
6	39514-0006	
7	39514-0007	
8	39514-0008	

Circuits	Order No.	Lead-free
9	39514-0009	Yes
10	39514-0010	
11	39514-0011	
12	39514-0012	
13	39514-0013	
14	39514-0014	
15	39514-0015	

Circuits	Order No.	Lead-free
16	39514-0016	Yes
17	39514-0017	
18	39514-0018	
19	39514-0019	
20	39514-0020	

Note: Standard 10A (1, 2, 3...) and reverse 11A (3, 2, 1...) imprinting available.
Please refer to sales drawing for additional order numbers (available on the web).

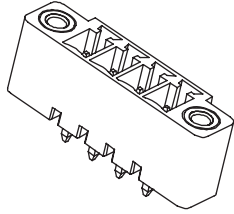
3.81mm (.150") Pitch**ESE
Pluggable PCB
Terminal Blocks****39515****Vertical PCB Header
with Threaded Retention Inserts****Features and Benefits**

- Two optional styles of imprinting make identifying, testing and wiring easier in the field
- Polarized to prevent mismatching

Reference Information

Packaging: Tray
 UL File No.: E48521
 Mates With: 39514 and 39517
 Designed In: Inches

Electrical

Voltage: 300V
 Current: 8.0A
 Insulation Resistance: 500 Megohms min.

Physical

Housing: Polyamide 6/6, black
 Terminal: Brass
 Plating: Terminal Area—Tin
 Operating Temperature: -40 to +115°C

Circuits	Order No.	Lead-free
2	39515-1002	Yes
3	39515-1003	
4	39515-1004	
5	39515-1005	
6	39515-1006	
7	39515-1007	
8	39515-1008	

Circuits	Order No.	Lead-free
9	39515-1009	Yes
10	39515-1010	
11	39515-1011	
12	39515-1012	
13	39515-1013	
14	39515-1014	
15	39515-1015	

Circuits	Order No.	Lead-free
16	39515-1016	Yes
17	39515-1017	
18	39515-1018	
19	39515-1019	
20	39515-1020	

Note: Standard 10A (1, 2, 3...) and reverse 11A (3, 2, 1...) imprinting available.
 Please refer to sales drawing for additional order numbers (available on the web).

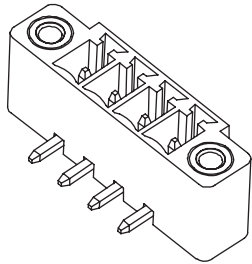
3.81mm (.150") Pitch**ESE
Pluggable PCB
Terminal Blocks****39516****Horizontal PCB Header
with Threaded Retention Inserts****Features and Benefits**

- Two optional styles of imprinting make identifying, testing and wiring easier in the field
- Polarized to prevent mismatching

Reference Information

Packaging: Tray
 UL File No.: E48521
 Mates With: 39514 and 39517
 Designed In: Inches

Electrical

Voltage: 300V
 Current: 8.0A
 Insulation Resistance: 500 Megohms min.

Physical

Housing: Polyamide 6/6, black
 Terminal: Brass
 Plating: Terminal Area—Tin
 Operating Temperature: -40 to +115°C

Circuits	Order No.	Lead-free
2	39516-1002	Yes
3	39516-1003	
4	39516-1004	
5	39516-1005	
6	39516-1006	
7	39516-1007	
8	39516-1008	

Circuits	Order No.	Lead-free
9	39516-1009	Yes
10	39516-1010	
11	39516-1011	
12	39516-1012	
13	39516-1013	
14	39516-1014	
15	39516-1015	

Circuits	Order No.	Lead-free
16	39516-1016	Yes
17	39516-1017	
18	39516-1018	
19	39516-1019	
20	39516-1020	

Note: Standard 10A (1, 2, 3...) and reverse 11A (3, 2, 1...) imprinting available.
 Please refer to sales drawing for additional order numbers (available on the web).

5.00mm (.197") Pitch Beau™ Eurostyle™ Pluggable PCB Terminal Blocks Positive Locking System

39990/39991
Vertical Plug

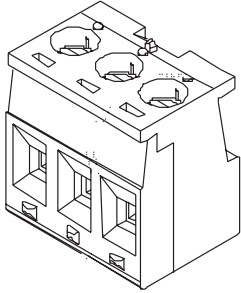

Features and Benefits

- Unique latching system resists vibration and provides audible and visual indication when mating
- Screwdriver required to unmate, preventing the accidental unmating of critical circuits
- Polarization feature eliminates the potential for mis-mating and facilitates blind mating
- Rising cage clamp holds wires for secure, reliable contact

Reference Information

Packaging: Tray
UL File No.: E48521
Flammability: UL 94V-0
Mates With: 39990 and 39991 PCB headers

Electrical

Voltage: 300V
Current: 10.0A
Insulation Resistance: 5000 Megohms min.

Mechanical

Recommended Tightening Torque: 0.56Nm (5.0 in.-lb.)

Physical

Housing: Polyamide 6/6, black
Terminal: Bronze
Screw: Steel, M3
Cage Clamp: Brass
Plating: Terminal—Tin or Gold
Screw—Zinc with clear chromate
Cage Clamp—Nickel
Wire Range: 14 to 24 AWG
Operating Temperature: -40°C to +105°C

Circuits	Order No.		Lead-free
	Tin Plated	Gold Plated	
2	39990-0302	39991-0302	Yes
3	39990-0303	39991-0303	
4	39990-0304	39991-0304	
5	39990-0305	39991-0305	
6	39990-0306	39991-0306	
7	39990-0307	39991-0307	
8	39990-0308	39991-0308	
9	39990-0309	39991-0309	
10	39990-0310	39991-0310	

Circuits	Order No.		Lead-free
	Tin Plated	Gold Plated	
11	39990-0311	39991-0311	Yes
12	39990-0312	39991-0312	
13	39990-0313	39991-0313	
14	39990-0314	39991-0314	
15	39990-0315	39991-0315	
16	39990-0316	39991-0316	
17	39990-0317	39991-0317	
18	39990-0318	39991-0318	

5.00mm (.197") Pitch Beau™ Eurostyle™ Pluggable PCB Terminal Blocks Positive Locking System

39990/39991
Vertical PCB Header

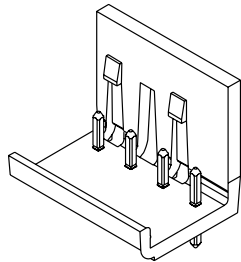

Features and Benefits

- Unique latching system resists vibration and provides audible and visual indication when mating
- Screwdriver required to unmate, preventing the accidental unmating of critical circuits
- Polarization feature eliminates the potential for mis-mating and facilitates blind mating

Reference Information

Packaging: Tray
UL File No.: E48521
Flammability: UL 94V-0
Mates With: 39990 and 39991 Plugs

Electrical

Voltage: 300V
Current: 10.0A
Insulation Resistance: 5000 Megohms min.

Physical

Housing: Polyamide 6/6, black
Terminal: Brass
Plating: Tin or Gold
Operating Temperature: -40°C to +105°C

Circuits	Order No.		Lead-free
	Tin Plated	Gold Plated	
2	39990-0402	39991-0402	
3	39990-0403	39991-0403	
4	39990-0404	39991-0404	
5	39990-0405	39991-0405	
6	39990-0406	39991-0406	
7	39990-0407	39991-0407	
8	39990-0408	39991-0408	
9	39990-0409	39991-0409	
10	39990-0410	39991-0410	

Circuits	Order No.		Lead-free
	Tin Plated	Gold Plated	
11	39990-0411	39991-0411	
12	39990-0412	39991-0412	
13	39990-0413	39991-0413	
14	39990-0414	39991-0414	
15	39990-0415	39991-0415	
16	39990-0416	39991-0416	
17	39990-0417	39991-0417	
18	39990-0418	39991-0418	

5.00mm (.197") Pitch ESE Pluggable PCB Terminal Blocks

39523 Vertical Plug

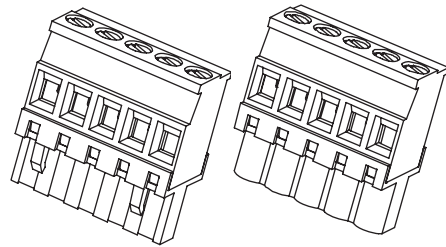

Front Wire Entry

Rear Wire Entry

Features and Benefits

- Two optional styles of imprinting make identifying, testing and wiring easier in the field
- Polarized to prevent mismatching

Reference Information

Packaging: Tray
UL File No.: E48521
Mates With: 39521, 39522 and 39528
Designed In: Inches

Electrical

Voltage: 300V
Current: 18.0A
Insulation Resistance: 500 Megohms min.

Mechanical

Recommended Tightening Torque: 0.45Nm (4 in.-lb)

Physical

Housing: Polyamide 6/6, black
Terminal: Phosphor Bronze
Cage Clamp: Brass
Screw: Steel, M3
Plating: Terminal Area—Tin
Cage Clamp—Nickel
Screw—Zinc
Wire Range: 12 to 30 AWG
Operating Temperature: -40 to +115°C

Circuits	Order No.		Lead-free
	Front Wire Entry	Rear Wire Entry	
2	39523-3002	39523-2002	Yes
3	39523-3003	39523-2003	
4	39523-3004	39523-2004	
5	39523-3005	39523-2005	
6	39523-3006	39523-2006	
7	39523-3007	39523-2007	
8	39523-3008	39523-2008	
9	39523-3009	39523-2009	
10	39523-3010	39523-2010	
11	39523-3011	39523-2011	
12	39523-3012	39523-2012	
13	39523-3013	39523-2013	

Note: Standard 10A (1, 2, 3...) and reverse 11A (3, 2, 1...) imprinting available. Please refer to sales drawing for additional order numbers (available on the web).

Circuits	Order No.		Lead-free
	Front Wire Entry	Rear Wire Entry	
14	39523-3014	39523-2014	Yes
15	39523-3015	39523-2015	
16	39523-3016	39523-2016	
17	39523-3017	39523-2017	
18	39523-3018	39523-2018	
19	39523-3019	39523-2019	
20	39523-3020	39523-2020	
21	39523-3021	39523-2021	
22	39523-3022	39523-2022	
23	39523-3023	39523-2023	
24	39523-3024	39523-2024	

5.00mm (.197") Pitch ESE Pluggable PCB Terminal Blocks

39520 Horizontal Plug

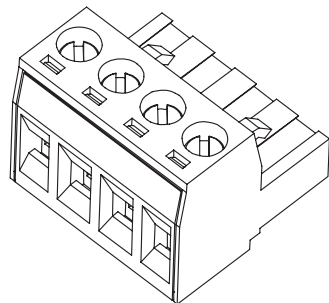

Features and Benefits

- Two optional styles of imprinting make identifying, testing and wiring easier in the field
- Polarized to prevent mismatching

Reference Information

Packaging: Tray
UL File No.: E48521
Mates With: 39521, 39522 and 39528
Designed In: Inches

Electrical

Voltage: 300V
Current: 18.0A
Insulation Resistance: 500 Megohms min.

Mechanical

Recommended Tightening Torque: 0.45Nm (4 in.-lb)

Physical

Housing: Polyamide 6/6, black
Terminal: Phosphor Bronze
Cage Clamp: Brass
Screw: Steel, M3
Plating: Terminal Area—Tin
Cage Clamp—Nickel
Screw—Zinc
Wire Range: 16 to 30 AWG
Operating Temperature: -40 to +115°C

Circuits	Order No.	Lead-free
2	39520-0002	Yes
3	39520-0003	
4	39520-0004	
5	39520-0005	
6	39520-0006	
7	39520-0007	
8	39520-0008	
9	39520-0009	

Circuits	Order No.	Lead-free
10	39520-0010	Yes
11	39520-0011	
12	39520-0012	
13	39520-0013	
14	39520-0014	
15	39520-0015	
16	39520-0016	
17	39520-0017	

Circuits	Order No.	Lead-free
18	39520-0018	Yes
19	39520-0019	
20	39520-0020	
21	39520-0021	
22	39520-0022	
23	39520-0023	
24	39520-0024	

Note: Standard 10A (1, 2, 3...) and reverse 11A (3, 2, 1...) imprinting available. Please refer to sales drawing for additional order numbers (available on the web).

5.00mm (.197") Pitch ESE Pluggable PCB Terminal Blocks

39521 Vertical PCB Header

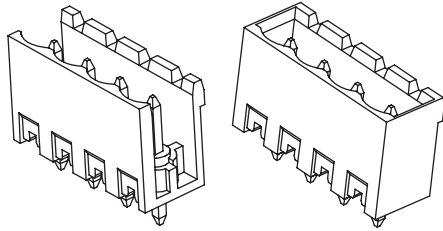

Open Ends

Closed Ends and SMC

Features and Benefits

- SMC PCB headers withstand reflow soldering temperatures
- Two optional styles of imprinting make identifying, testing and wiring easier in the field
- Polarized to prevent mismatching

Reference Information

Packaging: Tray
UL File No.: E48521
Mates With: 39520 and 39523
Designed In: Inches

Electrical

Voltage: 300V
Current: 18.0A
Insulating Resistance: 500 Megohms min.

Physical

Housing: Polyamide 6/6, black
SMC Headers—Polyamide 4/6, black
Terminal: Brass
Plating: Terminal Area—Tin
Operating Temperature: -40 to +115°C

Circuits	Order No.			Lead-free
	Open Ends	Closed Ends	Surface Mount Compatible	
2	39521-0002	39521-1002	39521-4002	Yes
3	39521-0003	39521-1003	39521-4003	
4	39521-0004	39521-1004	39521-4004	
5	39521-0005	39521-1005	39521-4005	
6	39521-0006	39521-1006	39521-4006	
7	39521-0007	39521-1007	39521-4007	
8	39521-0008	39521-1008	39521-4008	
9	39521-0009	39521-1009	39521-4009	
10	39521-0010	39521-1010	39521-4010	
11	39521-0011	39521-1011	39521-4011	
12	39521-0012	39521-1012	39521-4012	
13	39521-0013	39521-1013	39521-4013	

Circuits	Order No.			Lead-free
	Open Ends	Closed Ends	Surface Mount Compatible	
14	39521-0014	39521-1014	39521-4014	Yes
15	39521-0015	39521-1015	39521-4015	
16	39521-0016	39521-1016	39521-4016	
17	39521-0017	39521-1017	39521-4017	
18	39521-0018	39521-1018	39521-4018	
19	39521-0019	39521-1019	39521-4019	
20	39521-0020	39521-1020	39521-4020	
21	39521-0021	39521-1021	39521-4021	
22	39521-0022	39521-1022	39521-4022	
23	39521-0023	39521-1023	39521-4023	
24	39521-0024	39521-1024	39521-4024	

Note: Standard 10A (1, 2, 3...) and reverse 11A (3, 2, 1...) imprinting available.
Please refer to sales drawing for additional order numbers (available on the web).

5.00mm (.197") Pitch ESE Pluggable PCB Terminal Blocks

39522

Horizontal PCB Header Closed Ends, Open Ends and Surface Mount Compatible

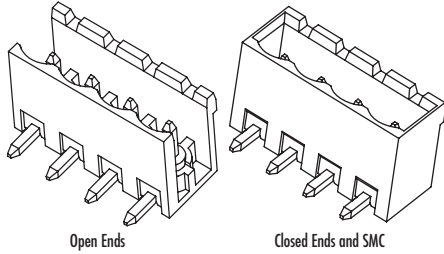

Open Ends

Closed Ends and SMC

Features and Benefits

- SMC PCB headers withstand reflow soldering temperatures
- Two optional styles of imprinting make identifying, testing and wiring easier in the field
- Polarized prevent mismatching

Reference Information

Packaging: Tray
UL File No.: E48521
Mates With: 39520 and 39523
Designed In: Inches

Electrical

Voltage: 300V
Current: 18.0A
Insulation Resistance: 500 Megohms min.

Physical

Housing: Polyamide 6/6, black
SMC Headers—Polyamide 4/6, black
Terminal: Brass
Plating: Terminal Area—Tin
Operating Temperature: -40 to +115°C

Circuits	Order No.			Lead-free
	Open Ends	Closed Ends	Surface Mount Compatible	
2	39522-0002	39522-1002	39522-4002	Yes
3	39522-0003	39522-1003	39522-4003	
4	39522-0004	39522-1004	39522-4004	
5	39522-0005	39522-1005	39522-4005	
6	39522-0006	39522-1006	39522-4006	
7	39522-0007	39522-1007	39522-4007	
8	39522-0008	39522-1008	39522-4008	
9	39522-0009	39522-1009	39522-4009	
10	39522-0010	39522-1010	39522-4010	
11	39522-0011	39522-1011	39522-4011	
12	39522-0012	39522-1012	39522-4012	
13	39522-0013	39522-1013	39522-4013	

Note: Standard 10A (1, 2, 3...) and reverse 11A (3, 2, 1...) imprinting available.
Please refer to sales drawing for additional order numbers (available on the web).

Circuits	Order No.			Lead-free
	Open Ends	Closed Ends	Surface Mount Compatible	
14	39522-0014	39522-1014	39522-4014	Yes
15	39522-0015	39522-1015	39522-4015	
16	39522-0016	39522-1016	39522-4016	
17	39522-0017	39522-1017	39522-4017	
18	39522-0018	39522-1018	39522-4018	
19	39522-0019	39522-1019	39522-4019	
20	39522-0020	39522-1020	39522-4020	
21	39522-0021	39522-1021	39522-4021	
22	39522-0022	39522-1022	39522-4022	
23	39522-0023	39522-1023	39522-4023	
24	39522-0024	39522-1024	39522-4024	

5.00mm (.197") Pitch ESE Pluggable PCB Terminal Blocks

39528

Dual Level Horizontal PCB Header

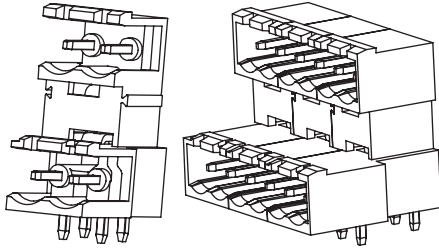

Open Ends

Closed Ends

Features and Benefits

- Offset dual level header allows easy access for wiring and testing on a crowded board
- Two optional styles of imprinting make identifying, testing and wiring easier in the field
- Polarized to prevent mismatching

Reference Information

Packaging: Tray
UL File No.: E48521
Mates With: 39520 and 39523
Designed In: Inches

Electrical

Voltage: 300V
Current: 18.0A
Insulation Resistance: 500 Megohms min.

Physical

Housing: Polyamide 6/6, black
Terminal: Brass
Plating: Terminal Area—Tin
Operating Temperature: -40 to +115°C

Circuits	Order No.		Lead-free
	Open Ends	Closed Ends	
4	39528-0004	39528-1004	Yes
6	39528-0006	39528-1006	
8	39528-0008	39528-1008	
10	39528-0010	39528-1010	
12	39528-0012	39528-1012	
14	39528-0014	39528-1014	
16	39528-0016	39528-1016	
18	39528-0018	39528-1018	
20	39528-0020	39528-1020	
22	39528-0022	39528-1022	
24	39528-0024	39528-1024	
26	39528-0026	39528-1026	

Circuits	Order No.		Lead-free
	Open Ends	Closed Ends	
28	39528-0028	39528-1028	Yes
30	39528-0030	39528-1030	
32	39528-0032	39528-1032	
34	39528-0034	39528-1034	
36	39528-0036	39528-1036	
38	39528-0038	39528-1038	
40	39528-0040	39528-1040	
42	39528-0042	39528-1042	
44	39528-0044	39528-1044	
46	39528-0046	39528-1046	
48	39528-0048	39528-1048	

Note: Standard 10A (1, 2, 3...) and reverse 11A (3, 2, 1...) imprinting available.
Please refer to sales drawing for additional order numbers (available on the web).

5.00mm (.197") Pitch

ESE

Pluggable PCB Terminal Blocks

39528

Dual Level Vertical PCB Header

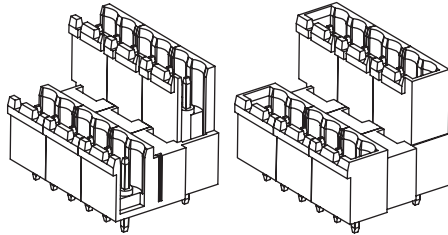

Open Ends

Closed Ends

Features and Benefits

- Offset dual level header allows easy access for wiring and testing on a crowded board
- Two optional styles of imprinting make identifying, testing and wiring easier in the field
- Polarized to prevent mismatching

Reference Information

Packaging: Tray
 UL File No.: E48521
 Mates With: 39520 and 39523
 Designed In: Inches

Electrical

Voltage: 300V
 Current: 18.0A
 Insulation Resistance: 500 Megohms min.

Physical

Housing: Polyamide 6/6, black
 Terminal: Brass
 Plating: Terminal Area—Tin
 Operating Temperature: -40 to +115°C

Circuits	Order No.		Lead-free
	Open Ends	Closed Ends	
4	39528-2004	39528-3004	Yes
6	39528-2006	39528-3006	
8	39528-2008	39528-3008	
10	39528-2010	39528-3010	
12	39528-2012	39528-3012	
14	39528-2014	39528-3014	
16	39528-2016	39528-3016	
18	39528-2018	39528-3018	
20	39528-2020	39528-3020	
22	39528-2022	39528-3022	
24	39528-2024	39528-3024	
26	39528-2026	39528-3026	

Note: Standard 10A (1, 2, 3...) and reverse 11A (3, 2, 1...) imprinting available.
 Please refer to sales drawing for additional order numbers (available on the web).

Circuits	Order No.		Lead-free
	Open Ends	Closed Ends	
28	39528-2028	39528-3028	Yes
30	39528-2030	39528-3030	
32	39528-2032	39528-3032	
34	39528-2034	39528-3034	
36	39528-2036	39528-3036	
38	39528-2038	39528-3038	
40	39528-2040	39528-3040	
42	39528-2042	39528-3042	
44	39528-2044	39528-3044	
46	39528-2046	39528-3046	
48	39528-2048	39528-3048	

5.00mm (.197") Pitch ESE Pluggable PCB Terminal Blocks

39527

Vertical Plug with Retention Screws

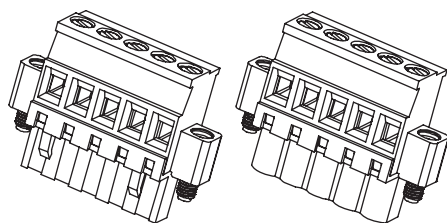

Front Wire Entry

Rear Wire Entry

Features and Benefits

- Two optional styles of imprinting make identifying, testing and wiring easier in the field
- Polarized to prevent mismatching

Reference Information

Packaging: Tray
UL File No.: E48521
Mates With: 39525 and 39526
Designed In: Inches

Electrical

Voltage: 300V
Current: 18.0A
Insulation Resistance: 500 Megohms min.

Mechanical

Recommended Tightening Torque: 0.45Nm (4 in.-lb)

Physical

Housing: Polyamide 6/6, black
Terminal: Phosphor Bronze
Cage Clamp: Brass
Screw: Steel, M3
Plating: Terminal Area—Tin
Cage Clamp—Nickel
Screw—Zinc
Wire Range: 12 to 30 AWG
Operating Temperature: -40 to +115°C

Circuits	Order No.		Lead-free
	Front Wire Entry	Rear Wire Entry	
2	39527-3002	39527-2002	Yes
3	39527-3003	39527-2003	
4	39527-3004	39527-2004	
5	39527-3005	39527-2005	
6	39527-3006	39527-2006	
7	39527-3007	39527-2007	
8	39527-3008	39527-2008	
9	39527-3009	39527-2009	
10	39527-3010	39527-2010	
11	39527-3011	39527-2011	
12	39527-3012	39527-2012	
13	39527-3013	39527-2013	

Circuits	Order No.		Lead-free
	Front Wire Entry	Rear Wire Entry	
14	39527-3014	39527-2014	Yes
15	39527-3015	39527-2015	
16	39527-3016	39527-2016	
17	39527-3017	39527-2017	
18	39527-3018	39527-2018	
19	39527-3019	39527-2019	
20	39527-3020	39527-2020	
21	39527-3021	39527-2021	
22	39527-3022	39527-2022	
23	39527-3023	39527-2023	
24	39527-3024	39527-2024	

Note: Standard 10A (1, 2, 3...) and reverse 11A (3, 2, 1...) imprinting available.
Please refer to sales drawing for additional order numbers (available on the web).

5.00mm (.197") Pitch ESE Pluggable PCB Terminal Blocks

39524

Horizontal Plug with Retention Screws

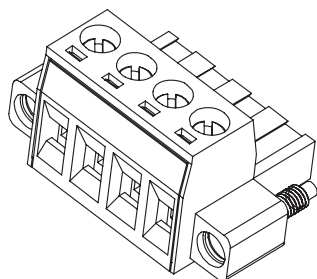

Features and Benefits

- Two optional styles of imprinting make identifying, testing and wiring easier in the field
- Polarized to prevent mismatching

Reference Information

Packaging: Tray
UL File No.: E48521
Mates With: 39525 and 39526
Designed In: Inches

Electrical

Voltage: 300V
Current: 18.0A
Insulation Resistance: 500 Megohms min.

Mechanical

Recommended Tightening Torque: 0.45Nm (4 in.-lb)

Physical

Housing: Polyamide 6/6, black
Terminal: Phosphor Bronze
Cage Clamp: Brass
Screw: Steel, M3
Plating: Terminal Area—Tin
Cage Clamp—Nickel
Screw—Zinc
Wire Range: 12 to 30 AWG
Operating Temperature: -40 to +115°C

Circuits	Order No.	Lead-free
2	39524-0002	Yes
3	39524-0003	
4	39524-0004	
5	39524-0005	
6	39524-0006	
7	39524-0007	
8	39524-0008	
9	39524-0009	

Circuits	Order No.	Lead-free
10	39524-0010	Yes
11	39524-0011	
12	39524-0012	
13	39524-0013	
14	39524-0014	
15	39524-0015	
16	39524-0016	
17	39524-0017	

Circuits	Order No.	Lead-free
18	39524-0018	Yes
19	39524-0019	
20	39524-0020	
21	39524-0021	
22	39524-0022	
23	39524-0023	
24	39524-0024	

Note: Standard 10A (1, 2, 3...) and reverse 11A (3, 2, 1...) imprinting available.
Please refer to sales drawing for additional order numbers (available on the web).

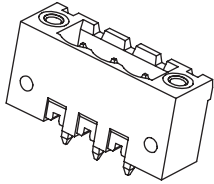
5.00mm (.197") Pitch**ESE
Pluggable PCB
Terminal Blocks****39525****Vertical PCB Header
with Threaded Retention Inserts****Features and Benefits**

- SMC PCB headers withstand reflow soldering temperatures
- Two optional styles of imprinting make identifying, testing and wiring easier in the field
- Polarized to prevent mismatching

Reference Information

Packaging: Tray
 UL File No.: E48521
 Mates With: 39524 and 39527
 Designed In: Inches

Electrical

Voltage: 300V
 Current: 18.0A
 Insulation Resistance: 500 Megohms min.

Physical

Housing: Polyamide 6/6, black
 SMC Headers—Polyamide 4/6, black
 Terminal: Brass
 Plating: Terminal Area—Tin
 Operating Temperature: -40 to +115°C

Circuits	Order No.		Lead-free
	Standard	Surface Mount Compatible	
2	39525-0002	39525-4002	Yes
3	39525-0003	39525-4003	
4	39525-0004	39525-4004	
5	39525-0005	39525-4005	
6	39525-0006	39525-4006	
7	39525-0007	39525-4007	
8	39525-0008	39525-4008	
9	39525-0009	39525-4009	
10	39525-0010	39525-4010	
11	39525-0011	39525-4011	
12	39525-0012	39525-4012	
13	39525-0013	39525-4013	

Note: Standard 10A (1, 2, 3...) and reverse 11A (3, 2, 1...) imprinting available. Contact Molex for order numbers. Please refer to sales drawing for additional order numbers (available on the web).

Circuits	Order No.		Lead-free
	Standard	Surface Mount Compatible	
14	39525-0014	39525-4014	Yes
15	39525-0015	39525-4015	
16	39525-0016	39525-4016	
17	39525-0017	39525-4017	
18	39525-0018	39525-4018	
19	39525-0019	39525-4019	
20	39525-0020	39525-4020	
21	39525-0021	39525-4021	
22	39525-0022	39525-4022	
23	39525-0023	39525-4023	
24	39525-0024	39525-4024	

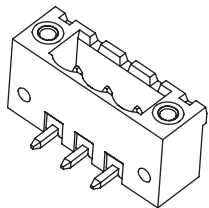
5.00mm (.197") Pitch**ESE
Pluggable PCB
Terminal Blocks****39526****Horizontal PCB Header
with Threaded Retention Inserts****Features and Benefits**

- SMC PCB headers withstand reflow soldering temperatures
- Two optional styles of imprinting make identifying, testing and wiring easier in the field
- Polarized to prevent mismatching

Reference Information

Packaging: Tray
 UL File No.: E48521
 Mates With: 39524 and 39527
 Designed In: Inches

Electrical

Voltage: 300V
 Current: 18.0A
 Insulation Resistance: 500 Megohms min.

Physical

Housing: Polyamide 6/6, black
 SMC Headers—Polyamide 4/6, black
 Terminal: Brass
 Plating: Terminal Area—Tin
 Operating Temperature: -40 to +115°C

Circuits	Order No.		Lead-free
	Standard	Surface Mount Compatible	
2	39526-0002	39526-4002	Yes
3	39526-0003	39526-4003	
4	39526-0004	39526-4004	
5	39526-0005	39526-4005	
6	39526-0006	39526-4006	
7	39526-0007	39526-4007	
8	39526-0008	39526-4008	
9	39526-0009	39526-4009	
10	39526-0010	39526-4010	
11	39526-0011	39526-4011	
12	39526-0012	39526-4012	
13	39526-0013	39526-4013	

Note: Standard 10A (1, 2, 3...) and reverse 11A (3, 2, 1...) imprinting available. Please refer to sales drawing for additional order numbers (available on the web).

Circuits	Order No.		Lead-free
	Standard	Surface Mount Compatible	
14	39526-0014	39526-4014	Yes
15	39526-0015	39526-4015	
16	39526-0016	39526-4016	
17	39526-0017	39526-4017	
18	39526-0018	39526-4018	
19	39526-0019	39526-4019	
20	39526-0020	39526-4020	
21	39526-0021	39526-4021	
22	39526-0022	39526-4022	
23	39526-0023	39526-4023	
24	39526-0024	39526-4024	

5.08mm (.200") Pitch Beau™ Eurostyle™ Pluggable PCB Terminal Blocks Positive Locking System

39980/39981
Vertical Plug

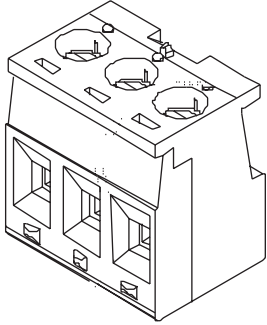

Features and Benefits

- Unique latching system resists vibration and provides audible and visual indication when mating
- Screwdriver required to unmate, preventing the accidental unmating of critical circuits
- Polarization feature eliminates the potential for mis-mating and facilitates blind mating
- Rising cage clamp holds wires for secure, reliable contact

Reference Information

Packaging: Tray
UL File No.: E48521
Flammability: UL 94V-0
Mates With: 39980 and 39981 PCB headers

Electrical

Voltage: 300V
Current: 10.0A
Insulation Resistance: 5000 Megohms min.

Mechanical

Recommended Tightening Torque: 0.56Nm (5.0 in.-lb.)

Physical

Housing: Polyamide 6/6, black
Terminal: Bronze
Screw: Steel, M3
Cage Clamp: Brass
Plating: Terminal—Tin or Gold
Screw—Zinc with clear chromate
Cage Clamp—Nickel
Wire Range: 14 to 24 AWG
Operating Temperature: -40°C to +105°C

Circuits	Order No.		Lead-free
	Tin Plated	Gold Plated	
2	39980-0302	39981-0302	Yes
3	39980-0303	39981-0303	
4	39980-0304	39981-0304	
5	39980-0305	39981-0305	
6	39980-0306	39981-0306	
7	39980-0307	39981-0307	
8	39980-0308	39981-0308	
9	39980-0309	39981-0309	
10	39980-0310	39981-0310	
11	39980-0311	39981-0311	
12	39980-0312	39981-0312	
13	39980-0313	39981-0313	

Circuits	Order No.		Lead-free
	Tin Plated	Gold Plated	
14	39980-0314	39981-0314	Yes
15	39980-0315	39981-0315	
16	39980-0316	39981-0316	
17	39980-0317	39981-0317	
18	39980-0318	39981-0318	
19	39980-0319	39981-0319	
20	39980-0320	39981-0320	
21	39980-0321	39981-0321	
22	39980-0322	39981-0322	
23	39980-0323	39981-0323	
24	39980-0324	39981-0324	

5.08mm (.200") Pitch Beau™ Eurostyle™ Pluggable PCB Terminal Blocks Positive Locking System

39980/39981

Vertical PCB Header

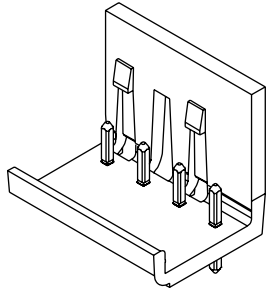

Features and Benefits

- Unique latching system resists vibration and provides audible and visual indication when mating
- Screwdriver required to unmate, preventing the accidental unmating of critical circuits
- Polarization feature eliminates the potential for mis-mating and facilitates blind mating

Reference Information

Packaging: Tray
UL File No.: E48521
Flammability: UL 94V-0
Mates With: 39980 and 39981 Plugs

Electrical

Voltage: 300V
Current: 10.0A
Insulation Resistance: 5,000 Megohms min.

Physical

Housing: Ployamide 6/6, black
Terminal: Brass
Plating: Tin or Gold
Operating Temperature: -40°C to +105°C

Circuits	Order No.		Lead-free
	Tin Plated	Gold Plated	
2	39980-0402	39981-0402	Yes
3	39980-0403	39981-0403	
4	39980-0404	39981-0404	
5	39980-0405	39981-0405	
6	39980-0406	39981-0406	
7	39980-0407	39981-0407	
8	39980-0408	39981-0408	
9	39980-0409	39981-0409	
10	39980-0410	39981-0410	
11	39980-0411	39981-0411	
12	39980-0412	39981-0412	
13	39980-0413	39981-0413	

Circuits	Order No.		Lead-free
	Tin Plated	Gold Plated	
14	39980-0414	39981-0414	Yes
15	39980-0415	39981-0415	
16	39980-0416	39981-0416	
17	39980-0417	39981-0417	
18	39980-0418	39981-0418	
19	39980-0419	39981-0419	
20	39980-0420	39981-0420	
21	39980-0421	39981-0421	
22	39980-0422	39981-0422	
23	39980-0423	39981-0423	
24	39980-0424	39981-0424	

5.08 mm (.200") Pitch Beau™ EuroMate™ Pluggable PCB Terminal Blocks

39940

Vertical Plug Rear and Front Wire Entry

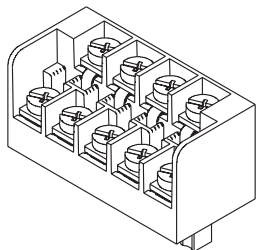

Features and Benefits

- Pluggable barrier strip combines the benefits of pluggable Eurostyle design and the flexibility of barrier terminal strips
- Wiring terminals are staggered and offset vertically to facilitate easier wiring access
- Rear barrier prevents over-insertion of wire into terminal block
- Single row of female contacts interface with industry standard Eurostyle PCB headers, which produces twice the pitch at the wiring terminal

Reference Information

Packaging: Tray
UL File No.: E48521
Flammability: UL 94V-0
Mates With: Most industry standard 5.08mm (.200") pitch PCB headers

Electrical

Voltage: 300V
Current: 15.0A
Insulation Resistance: 5000 Megohms min

Mechanical

Recommended Tightening Torque: 0.79Nm (7.0 in-lb.)

Physical

Housing: Polyamide 6/6, black
Terminal: Copper
Screw With Square Washer: Steel, M3.5
Plating: Terminal—Tin
Screw—Zinc with clear Chromate
Wire Range: 12 to 22 AWG
Operating Temperature: -40°C to +120°C

Circuits	Order No.		Lead-free
	Rear Wire Entry	Front Wire Entry	
3	39940-0203	39940-0303	Yes
4	39940-0204	39940-0304	
5	39940-0205	39940-0305	
6	39940-0206	39940-0306	
7	39940-0207	39940-0307	
8	39940-0208	39940-0308	
9	39940-0209	39940-0309	
10	39940-0210	39940-0310	
11	39940-0211	39940-0311	
12	39940-0212	39940-0312	
13	39940-0213	39940-0313	

Circuits	Order No.		Lead-free
	Rear Wire Entry	Front Wire Entry	
14	39940-0214	39940-0314	Yes
15	39940-0215	39940-0315	
16	39940-0216	39940-0316	
17	39940-0217	39940-0317	
18	39940-0218	39940-0318	
19	39940-0219	39940-0319	
20	39940-0220	39940-0320	
21	39940-0221	39940-0321	
22	39940-0222	39940-0322	
23	39940-0223	39940-0323	
24	39940-0224	39940-0324	

Note: Gold plating available. Contact your local Molex sales representative or distributor for order number.

5.08mm (.200") Pitch Beau™ EuroMate™ Pluggable PCB Terminal Blocks

39940

Vertical Plug with Mounting Ends Rear and Front Wire Entry

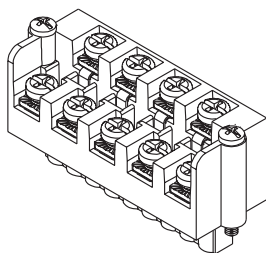

Features and Benefits

- Pluggable barrier strip combines the benefits of pluggable Eurostyle design and the flexibility of barrier terminal strips
- Wiring terminals are staggered and offset vertically to facilitate easier wiring access
- Rear barrier prevents over-insertion of wire into terminal block
- Single row of female contacts interface with industry standard Eurostyle PCB headers, which produces twice the pitch at the wiring terminal

Reference Information

Packaging: Tray
UL File No.: E48521
Flammability: UL 94V-0
Mates With: Most industry standard 5.08mm (.200") pitch PCB headers

Electrical

Voltage: 300V
Current: 15.0A
Insulation Resistance: 5000 Megohms min.

Mechanical

Recommended Tightening Torque: 0.79Nm (7.0 in-lb.)

Physical

Housing: Polyamide 6/6, black
Terminal: Bronze
Screw with Square Washer: Steel, M3.5
Plating: Terminal—Tin
Screw—Zinc with yellow chromate
Wire Range: 12 to 22 AWG
Operating Temperature: -40°C to +120°C

Circuits	Order No.		Lead-free
	Rear Wire Entry	Front Wire Entry	
3	39940-0403	39940-0503	
4	39940-0404	39940-0504	
5	39940-0405	39940-0505	
6	39940-0406	39940-0506	
7	39940-0407	39940-0507	
8	39940-0408	39940-0508	
9	39940-0409	39940-0509	
10	39940-0410	39940-0510	
11	39940-0411	39940-0511	
12	39940-0412	39940-0512	
13	39940-0413	39940-0513	

Circuits	Order No.		Lead-free
	Rear Wire Entry	Front Wire Entry	
14	39940-0414	39940-0514	
15	39940-0415	39940-0515	
16	39940-0416	39940-0516	
17	39940-0417	39940-0517	
18	39940-0418	39940-0518	
19	39940-0419	39940-0519	
20	39940-0420	39940-0520	
21	39940-0421	39940-0521	
22	39940-0422	39940-0522	
23	39940-0423	39940-0523	
24	39940-0424	39940-0524	

Note: Gold plating available. Contact your local Molex sales representative or distributor for order number.

5.08mm (.200") Pitch ESE Pluggable PCB Terminal Blocks

39533 Vertical Plug

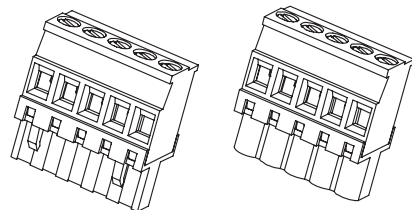

Front Wire Entry

Rear Wire Entry

Features and Benefits

- Two optional styles of imprinting make identifying, testing and wiring easier in the field
- Polarized to prevent mismatching

Reference Information

Packaging: Tray
UL File No.: E48521
Mates With:
39531, 39532 and 39538
Designed In: Inches

Electrical

Voltage: 300V
Current: 18.0A
Insulation Resistance: 500 Megohms min.

Mechanical

Recommended Tightening Torque: 0.45Nm (4 in.-lb)

Physical

Housing: Polyamide 6/6, black
Terminal: Phosphor Bronze
Cage Clamp: Brass
Screw: Steel, M3
Plating: Terminal Area—Tin
Cage Clamp—Nickel
Screw—Zinc
Wire Range: 12 to 30 AWG
Operating Temperature: -40 to +115°C

Circuits	Order No.		Lead-free
	Front Wire Entry	Rear Wire Entry	
2	39533-3002	39533-2002	Yes
3	39533-3003	39533-2003	
4	39533-3004	39533-2004	
5	39533-3005	39533-2005	
6	39533-3006	39533-2006	
7	39533-3007	39533-2007	
8	39533-3008	39533-2008	
9	39533-3009	39533-2009	
10	39533-3010	39533-2010	
11	39533-3011	39533-2011	
12	39533-3012	39533-2012	
13	39533-3013	39533-2013	

Note: Standard 10A (1, 2, 3...) and reverse 11A (3, 2, 1...) imprinting available.
Please refer to sales drawing for additional order numbers (available on the web).

Circuits	Order No.		Lead-free
	Front Wire Entry	Rear Wire Entry	
14	39533-3014	39533-2014	Yes
15	39533-3015	39533-2015	
16	39533-3016	39533-2016	
17	39533-3017	39533-2017	
18	39533-3018	39533-2018	
19	39533-3019	39533-2019	
20	39533-3020	39533-2020	
21	39533-3021	39533-2021	
22	39533-3022	39533-2022	
23	39533-3023	39533-2023	
24	39533-3024	39533-2024	

5.08mm (.200") Pitch ESE Pluggable PCB Terminal Blocks

39530 Horizontal Plug

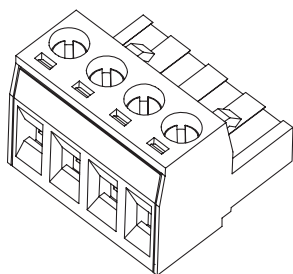

Features and Benefits

- Two optional styles of imprinting make identifying, testing and wiring easier in the field
- Polarized to prevent mismatching

Reference Information

Packaging: Tray
UL File No.: E48521
Mates With: 39531, 39532 and 39538
Designed In: Inches

Electrical

Voltage: 300V
Current: 18.0A
Insulation Resistance: 500 Megohms min.

Mechanical

Recommended Tightening Torque: 0.45Nm (4 in.-lb)

Physical

Housing: Polyamide 6/6, black
Terminal: Phosphor Bronze
Cage Clamp: Brass
Screw: Steel, M3
Plating: Terminal Area—Tin
Cage Clamp—Nickel
Screw—Zinc
Wire Range: 12 to 30 AWG
Operating Temperature: -40 to +115°C

Circuits	Order No.	Lead-free
2	39530-0002	Yes
3	39530-0003	
4	39530-0004	
5	39530-0005	
6	39530-0006	
7	39530-0007	
8	39530-0008	
9	39530-0009	

Circuits	Order No.	Lead-free
10	39530-0010	Yes
11	39530-0011	
12	39530-0012	
13	39530-0013	
14	39530-0014	
15	39530-0015	
16	39530-0016	
17	39530-0017	

Circuits	Order No.	Lead-free
18	39530-0018	Yes
19	39530-0019	
20	39530-0020	
21	39530-0021	
22	39530-0022	
23	39530-0023	
24	39530-0024	

Note: Standard 10A (1, 2, 3...) and reverse 11A (3, 2, 1...) imprinting available.
Please refer to sales drawing for additional order numbers (available on the web).

5.08mm (.200") Pitch ESE Pluggable PCB Terminal Blocks

39531

Vertical PCB Header

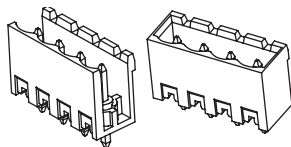

Open Ends

Closed Ends and SMC

Features and Benefits

- SMC PCB headers withstand reflow soldering temperatures
- Two optional styles of imprinting make identifying, testing and wiring easier in the field
- Polarized to prevent mismatching

Reference Information

Packaging: Tray
UL File No.: E48521
Mates With: 39530 and 39533
Designed In: Inches

Electrical

Voltage: 300V
Current: 18.0A
Insulation Resistance: 500 Megohms min.

Physical

Housing: Polyamide 6/6, black
SMC Headers—Polyamide 4/6, black
Terminal: Brass
Plating: Terminal Area—Tin
Operating Temperature: -40 to +115°C

Circuits	Order No.			Lead-free
	Open Ends	Closed Ends	Surface Mount Compatible	
2	39531-0002	39531-1002	39531-4002	Yes
3	39531-0003	39531-1003	39531-4003	
4	39531-0004	39531-1004	39531-4004	
5	39531-0005	39531-1005	39531-4005	
6	39531-0006	39531-1006	39531-4006	
7	39531-0007	39531-1007	39531-4007	
8	39531-0008	39531-1008	39531-4008	
9	39531-0009	39531-1009	39531-4009	
10	39531-0010	39531-1010	39531-4010	
11	39531-0011	39531-1011	39531-4011	
12	39531-0012	39531-1012	39531-4012	
13	39531-0013	39531-1013	39531-4013	

Note: Standard 10A (1, 2, 3...) and reverse 11A (3, 2, 1...) imprinting available.
Please refer to sales drawing for additional order numbers (available on the web).

Circuits	Order No.			Lead-free
	Open Ends	Closed Ends	Surface Mount Compatible	
14	39531-0014	39531-1014	39531-4014	Yes
15	39531-0015	39531-1015	39531-4015	
16	39531-0016	39531-1016	39531-4016	
17	39531-0017	39531-1017	39531-4017	
18	39531-0018	39531-1018	39531-4018	
19	39531-0019	39531-1019	39531-4019	
20	39531-0020	39531-1020	39531-4020	
21	39531-0021	39531-1021	39531-4021	
22	39531-0022	39531-1022	39531-4022	
23	39531-0023	39531-1023	39531-4023	
24	39531-0024	39531-1024	39531-4024	

5.08mm (.200") Pitch ESE Pluggable PCB Terminal Blocks

39532

Horizontal PCB Header

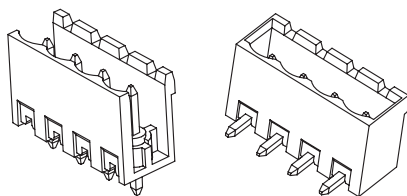

Open Ends

Closed Ends and SMC

Features and Benefits

- SMC PCB headers withstand reflow soldering temperatures
- Two optional styles of imprinting make identifying, testing and wiring easier in the field
- Polarized to prevent mismatching

Reference Information

Packaging: Tray
UL File No.: E48521
Mates With: 39530 and 39533
Designed In: Inches

Electrical

Voltage: 300V
Current: 18.0A
Insulation Resistance: 500 Megohms min.

Physical

Housing: Polyamide 6/6, black
SMC Headers—Polyamide 4/6, black
Terminal: Brass
Plating: Terminal Area—Tin
Operating Temperature: -40 to +115°C

Circuits	Order No.			Lead-free
	Open Ends	Closed Ends	Surface Mount Compatible	
2	39532-0002	39532-1002	39532-4002	Yes
3	39532-0003	39532-1003	39532-4003	
4	39532-0004	39532-1004	39532-4004	
5	39532-0005	39532-1005	39532-4005	
6	39532-0006	39532-1006	39532-4006	
7	39532-0007	39532-1007	39532-4007	
8	39532-0008	39532-1008	39532-4008	
9	39532-0009	39532-1009	39532-4009	
10	39532-0010	39532-1010	39532-4010	
11	39532-0011	39532-1011	39532-4011	
12	39532-0012	39532-1012	39532-4012	
13	39532-0013	39532-1013	39532-4013	

Note: Standard 10A (1, 2, 3...) and reverse 11A (3, 2, 1...) imprinting available.
Please refer to sales drawing for additional order numbers (available on the web).

Circuits	Order No.			Lead-free
	Open Ends	Closed Ends	Surface Mount Compatible	
14	39532-0014	39532-1014	39532-4014	Yes
15	39532-0015	39532-1015	39532-4015	
16	39532-0016	39532-1016	39532-4016	
17	39532-0017	39532-1017	39532-4017	
18	39532-0018	39532-1018	39532-4018	
19	39532-0019	39532-1019	39532-4019	
20	39532-0020	39532-1020	39532-4020	
21	39532-0021	39532-1021	39532-4021	
22	39532-0022	39532-1022	39532-4022	
23	39532-0023	39532-1023	39532-4023	
24	39532-0024	39532-1024	39532-4024	

5.08mm (.200") Pitch

ESE

Pluggable PCB Terminal Blocks

39538

Dual Level Horizontal PCB Header

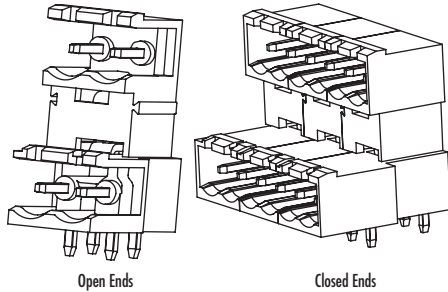

Open Ends

Closed Ends

Features and Benefits

- Offset dual level header allows easy access for wiring and testing on a crowded board
- Two optional styles of imprinting make identifying, testing and wiring easier in the field
- Polarized to prevent mismatching

Reference Information

Packaging: Tray
 UL File No.: E48521
 Mates With: 39530 and 39533
 Designed In: Inches

Electrical

Voltage: 300V
 Current: 18.0A
 Insulation Resistance: 500 Megohms min.

Physical

Housing: Polyamide 6/6, black
 Terminal: Brass
 Plating: Terminal Area—Tin
 Operating Temperature: -40 to +115°C

Circuits	Order No.		Lead-free
	Open Ends	Closed Ends	
4	39538-0004	39538-1004	Yes
6	39538-0006	39538-1006	
8	39538-0008	39538-1008	
10	39538-0010	39538-1010	
12	39538-0012	39538-1012	
14	39538-0014	39538-1014	
16	39538-0016	39538-1016	
18	39538-0018	39538-1018	
20	39538-0020	39538-1020	
22	39538-0022	39538-1022	
24	39538-0024	39538-1024	
26	39538-0026	39538-1026	

Circuits	Order No.		Lead-free
	Open Ends	Closed Ends	
28	39538-0028	39538-1028	Yes
30	39538-0030	39538-1030	
32	39538-0032	39538-1032	
34	39538-0034	39538-1034	
36	39538-0036	39538-1036	
38	39538-0038	39538-1038	
40	39538-0040	39538-1040	
42	39538-0042	39538-1042	
44	39538-0044	39538-1044	
46	39538-0046	39538-1046	
48	39538-0048	39538-1048	

Note: Standard 10A (1, 2, 3...) and reverse 11A (3, 2, 1...) imprinting available.
 Please refer to sales drawing for additional order numbers (available on the web).

5.08mm (.200") Pitch ESE Pluggable PCB Terminal Blocks

39538

Dual Level Vertical PCB Header

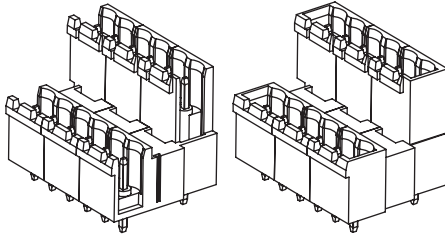

Open Ends

Closed Ends

Features and Benefits

- Offset dual level header allows easy access for wiring and testing on a crowded board
- Two optional styles of imprinting make identifying, testing and wiring easier in the field
- Polarized to prevent mismatching

Reference Information

Packaging: Tray
UL File No.: E48521
Mates With: 39530 and 39533
Designed In: Inches

Electrical

Voltage: 300V
Current: 18.0A
Insulation Resistance: 500 Megohms min.

Physical

Housing: Polyamide 6/6, black
Terminal: Brass
Plating: Terminal Area—Tin
Operating Temperature: -40 to +115°C

Circuits	Order No.		Lead-free
	Open Ends	Closed Ends	
4	39538-2004	39538-3004	Yes
6	39538-2006	39538-3006	
8	39538-2008	39538-3008	
10	39538-2010	39538-3010	
12	39538-2012	39538-3012	
14	39538-2014	39538-3014	
16	39538-2016	39538-3016	
18	39538-2018	39538-3018	
20	39538-2020	39538-3020	
22	39538-2022	39538-3022	
24	39538-2024	39538-3024	
26	39538-2026	39538-3026	

Circuits	Order No.		Lead-free
	Open Ends	Closed Ends	
28	39538-2028	39538-3028	Yes
30	39538-2030	39538-3030	
32	39538-2032	39538-3032	
34	39538-2034	39538-3034	
36	39538-2036	39538-3036	
38	39538-2038	39538-3038	
40	39538-2040	39538-3040	
42	39538-2042	39538-3042	
44	39538-2044	39538-3044	
46	39538-2046	39538-3046	
48	39538-2048	39538-3048	

Note: Standard 10A (1, 2, 3...) and reverse 11A (3, 2, 1...) imprinting available.
Please refer to sales drawing for additional order numbers (available on the web).

5.08mm (.200") Pitch ESE Pluggable PCB Terminal Blocks

39537 Vertical Plug with Retention Screws

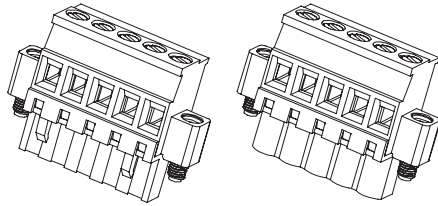

Front Wire Entry

Rear Wire Entry

Features and Benefits

- Two optional styles of imprinting make identifying, testing and wiring easier in the field
- Polarized to prevent mismatching

Reference Information

Packaging: Tray
UL File No.: E48521
Mates With: 39535 and 39536
Designed In: Inches

Electrical

Voltage: 300V
Current: 18.0A
Insulation Resistance: 500 Megohms min.

Mechanical

Recommended Tightening Torque: 0.45Nm (4 in.-lb)

Physical

Housing: Polyamide 6/6, black
Terminal: Phosphor Bronze
Cage Clamp: Brass
Screw: Steel, M3
Plating: Terminal Area—Tin
Cage Clamp—Nickel
Screw—Zinc
Wire Range: 12 to 30 AWG
Operating Temperature: -40 to +115°C

Circuits	Order No.		Lead-free
	Front Wire Entry	Rear Wire Entry	
2	39537-3002	39537-2002	Yes
3	39537-3003	39537-2003	
4	39537-3004	39537-2004	
5	39537-3005	39537-2005	
6	39537-3006	39537-2006	
7	39537-3007	39537-2007	
8	39537-3008	39537-2008	
9	39537-3009	39537-2009	
10	39537-3010	39537-2010	
11	39537-3011	39537-2011	
12	39537-3012	39537-2012	
13	39537-3013	39537-2013	

Note: Standard 10A (1, 2, 3...) and reverse 11A (3, 2, 1...) imprinting available.
Please refer to sales drawing for additional order numbers (available on the web).

Circuits	Order No.		Lead-free
	Front Wire Entry	Rear Wire Entry	
14	39537-3014	39537-2014	Yes
15	39537-3015	39537-2015	
16	39537-3016	39537-2016	
17	39537-3017	39537-2017	
18	39537-3018	39537-2018	
19	39537-3019	39537-2019	
20	39537-3020	39537-2020	
21	39537-3021	39537-2021	
22	39537-3022	39537-2022	
23	39537-3023	39537-2023	
24	39537-3024	39537-2024	

5.08mm (.200") Pitch ESE Pluggable PCB Terminal Blocks

39534 Horizontal Plug with Retention Screws

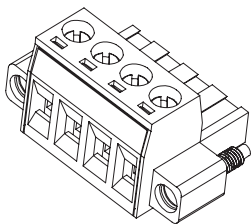

Features and Benefits

- Two optional styles of imprinting make identifying, testing and wiring easier in the field
- Polarized to prevent mismatching

Reference Information

Packaging: Tray
UL File No.: E48521
Mates With: 39535 and 39536
Designed In: Inches

Electrical

Voltage: 300V
Current: 18.0A
Insulation Resistance: 500 Megohms min.

Mechanical

Recommended Tightening Torque: 0.45Nm (4 in.-lb)

Physical

Housing: Polyamide 6/6, black
Terminal: Phosphor Bronze
Cage Clamp: Brass
Screw: Steel, M3
Plating: Terminal Area—Tin
Cage Clamp—Nickel
Screw—Zinc
Wire Range: 12 to 30 AWG
Operating Temperature: -40 to +115°C

Circuits	Order No.	Lead-free
2	39534-0002	Yes
3	39534-0003	
4	39534-0004	
5	39534-0005	
6	39534-0006	
7	39534-0007	
8	39534-0008	
9	39534-0009	

Circuits	Order No.	Lead-free
10	39534-0010	Yes
11	39534-0011	
12	39534-0012	
13	39534-0013	
14	39534-0014	
15	39534-0015	
16	39534-0016	
17	39534-0017	

Circuits	Order No.	Lead-free
18	39534-0018	Yes
19	39534-0019	
20	39534-0020	
21	39534-0021	
22	39534-0022	
23	39534-0023	
24	39534-0024	

Note: Standard 10A (1, 2, 3...) and reverse 11A (3, 2, 1...) imprinting available. Contact Molex for order numbers.
Please refer to sales drawing for additional order numbers (available on the web).

5.08mm (.200") Pitch ESE Pluggable PCB Terminal Blocks

39535

Vertical PCB Header with Threaded Retention Inserts

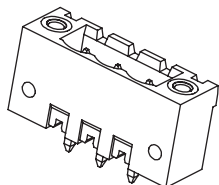

Features and Benefits

- SMC PCB headers withstand reflow soldering temperatures
- Two optional styles of imprinting make identifying, testing and wiring easier in the field
- Polarized to prevent mismatching

Reference Information

Packaging: Tray
UL File No.: E48521
Mates With: 39534 and 39537
Designed In: Inches

Electrical

Voltage: 300V
Current: 18.0A
Insulation Resistance: 500 Megohms min.

Physical

Housing: Polyamide 6/6, black
SMC Headers—Polyamide 4/6, black
Terminal: Brass
Plating: Terminal Area—Tin
Operating Temperature: -40 to +115°C

Circuits	Order No.		Lead-free
	Closed Ends	Surface Mount Compatible	
2	39535-0002	39535-4002	Yes
3	39535-0003	39535-4003	
4	39535-0004	39535-4004	
5	39535-0005	39535-4005	
6	39535-0006	39535-4006	
7	39535-0007	39535-4007	
8	39535-0008	39535-4008	
9	39535-0009	39535-4009	
10	39535-0010	39535-4010	
11	39535-0011	39535-4011	
12	39535-0012	39535-4012	
13	39535-0013	39535-4013	

Note: Standard 10A (1, 2, 3...) and reverse 11A (3, 2, 1...) imprinting available.
Please refer to sales drawing for additional order numbers (available on the web).

Circuits	Order No.		Lead-free
	Closed Ends	Surface Mount Compatible	
14	39535-0014	39535-4014	Yes
15	39535-0015	39535-4015	
16	39535-0016	39535-4016	
17	39535-0017	39535-4017	
18	39535-0018	39535-4018	
19	39535-0019	39535-4019	
20	39535-0020	39535-4020	
21	39535-0021	39535-4021	
22	39535-0022	39535-4022	
23	39535-0023	39535-4023	
24	39535-0024	39535-4024	

5.08mm (.200") Pitch ESE Pluggable PCB Terminal Blocks

39536

Horizontal PCB Header with Threaded Retention Inserts

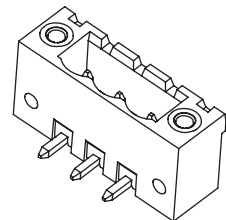

Features and Benefits

- SMC PCB headers withstand reflow soldering temperatures
- Two optional styles of imprinting make identifying, testing and wiring easier in the field
- Polarized to prevent mismatching

Reference Information

Packaging: Tray
UL File No.: E48521
Mates With: 39534 and 39537
Designed In: Inches

Electrical

Voltage: 300V
Current: 18.0A
Insulation Resistance: 500 Megohms min.

Physical

Housing: Polyamide 6/6, black
SMC Headers—Polyamide 4/6, black
Terminal: Brass
Plating: Terminal Area—Tin
Operating Temperature: -40 to +115°C

Circuits	Order No.		Lead-free
	Closed Ends	Surface Mount Compatible	
2	39536-0002	39536-4002	Yes
3	39536-0003	39536-4003	
4	39536-0004	39536-4004	
5	39536-0005	39536-4005	
6	39536-0006	39536-4006	
7	39536-0007	39536-4007	
8	39536-0008	39536-4008	
9	39536-0009	39536-4009	
10	39536-0010	39536-4010	
11	39536-0011	39536-4011	
12	39536-0012	39536-4012	
13	39536-0013	39536-4013	

Note: Standard 10A (1, 2, 3...) and reverse 11A (3, 2, 1...) imprinting available.
Please refer to sales drawing for additional order numbers (available on the web).

Circuits	Order No.		Lead-free
	Closed Ends	Surface Mount Compatible	
14	39536-0014	39536-4014	Yes
15	39536-0015	39536-4015	
16	39536-0016	39536-4016	
17	39536-0017	39536-4017	
18	39536-0018	39536-4018	
19	39536-0019	39536-4019	
20	39536-0020	39536-4020	
21	39536-0021	39536-4021	
22	39536-0022	39536-4022	
23	39536-0023	39536-4023	
24	39536-0024	39536-4024	

7.50mm (.295") Pitch Beau™ Eurostyle™ Pluggable PCB Terminal Blocks

39374

Vertical Plug Front and Rear Wire Entry

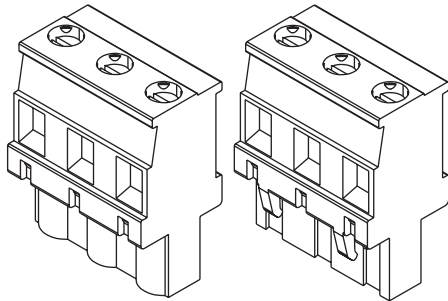

Rear Wire Entry

Front Wire Entry

Features and Benefits

- Latches secure plug to PCB header for a reliable connection
- Funnel entry housing provides easier wire insertion
- Rising cage clamp termination provides gas-tight connection without strand damage or intermittence

Reference Information

Packaging: Box
UL File No.: E48521
Flammability: UL 94V-0
Mates With: 39372 and 39373
Designed In: Millimeters

Electrical

Voltage: 300V
Current: 12.0A (15.0A with 12 AWG)
Insulation Resistance: 500 Megohms min.

Mechanical

Recommended Tightening Torque: 0.79Nm (7 in.-lb)

Physical

Housing: Polyamide 6/6
Terminal: Phosphor Bronze
Cage Clamp: Copper Alloy
Screw: Copper Alloy, M3
Plating: Terminal Area—Tin
Cage Clamp—Nickel
Screw—Nickel
Wire Range: 12 to 30 AWG
Operating Temperature: -40 to +105°C

Circuits	Order No.		Lead-free
	Front Wire Entry	Rear Wire Entry	
2	39374-0902	39374-0802	Yes
3	39374-0903	39374-0803	
4	39374-0904	39374-0804	
5	39374-0905	39374-0805	
6	39374-0906	39374-0806	
7	39374-0907	39374-0807	

Circuits	Order No.		Lead-free
	Front Wire Entry	Rear Wire Entry	
8	39374-0908	39374-0808	Yes
9	39374-0909	39374-0809	
10	39374-0910	39374-0810	
11	39374-0911	39374-0811	
12	39374-0912	39374-0812	

7.50mm (.295") Pitch Beau™ Eurostyle™ Pluggable PCB Terminal Blocks

39371

Horizontal Plug

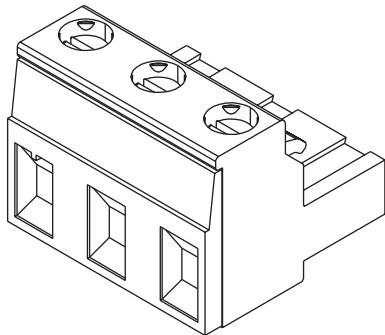

Features and Benefits

- Latches secure plug to PCB header for a reliable connection
- Funnel entry housing provides easier wire insertion
- Rising cage clamp termination provides gas-tight connection without strand damage or intermittence

Reference Information

Packaging: Box
UL File No.: E48521
Flammability: UL 94V-0
Mates With: 39372 and 39373
Designed In: Millimeters

Electrical

Voltage: 300V
Current: 12.0A (15.0A with 12AWG)
Insulation Resistance: 500 Megohms min.

Mechanical

Recommended Tightening Torque: 0.79Nm (7 in.-lb)

Physical

Housing: Polyamide 6/6
Terminal: Phosphor Bronze
Cage Clamp: Copper Alloy, M3
Screw: Copper Alloy
Plating: Terminal Area—Tin
Cage Clamp—Nickel
Screw—Nickel
Wire Range: 14 to 30 AWG
Operating Temperature: -40 to +105°C

Circuits	Order No.	Lead-free
2	39371-0002	Yes
3	39371-0003	
4	39371-0004	
5	39371-0005	

Circuits	Order No.	Lead-free
6	39371-0006	Yes
7	39371-0007	
8	39371-0008	
9	39371-0009	

Circuits	Order No.	Lead-free
10	39371-0010	Yes
11	39371-0011	
12	39371-0012	

7.50mm (.295") Pitch Beau™ Eurostyle™ Pluggable PCB Terminal Blocks

39372

Vertical PCB Header

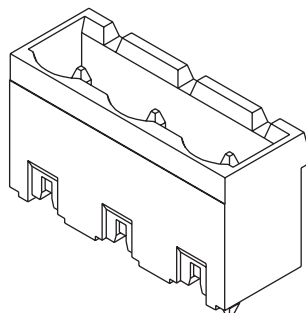

Features and Benefits

- Polarized PCB header prevents mis-mating
- Friction ramp secures PCB header to the plug for a reliable connection

Reference Information

Packaging: Box
UL File No.: E48521
Flammability: UL 94V-0
Mates With: 39371 and 39374
Designed In: Millimeters

Electrical

Voltage: 300V
Current: 15.0A
Insulation Resistance: 1000 Megohms min.

Physical

Housing: Polyamide 6/6
Terminal: Phosphor Bronze
Plating: Terminal Area—Tin
Operating Temperature: -40 to +105°C

Circuits	Order No.	Lead-free
2	39372-0002	Yes
3	39372-0003	
4	39372-0004	
5	39372-0005	

Circuits	Order No.	Lead-free
6	39372-0006	Yes
7	39372-0007	
8	39372-0008	
9	39372-0009	

Circuits	Order No.	Lead-free
10	39372-0010	Yes
11	39372-0011	
12	39372-0012	

7.50mm (.295") Pitch Beau™ Eurostyle™ Pluggable PCB Terminal Blocks

39373

Horizontal PCB Header

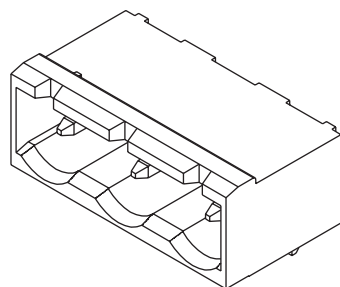

Features and Benefits

- Polarized PCB header prevents mis-mating
- Friction ramp secures PCB header to the plug for a reliable connection

Reference Information

Packaging: Box
UL File No.: E48521
Flammability: UL 94V-0
Mates With: 39371 and 39374
Designed In: Millimeters

Electrical

Voltage: 300V
Current: 15.0A
Insulation Resistance: 1000 Megohms min.

Physical

Housing: Polyamide 6/6
Terminal: Phosphor Bronze
Plating: Terminal Area—Tin
Operating Temperature: -40 to +105°C

Circuits	Order No.	Lead-free
2	39373-0002	Yes
3	39373-0003	
4	39373-0004	
5	39373-0005	

Circuits	Order No.	Lead-free
6	39373-0006	Yes
7	39373-0007	
8	39373-0008	
9	39373-0009	

Circuits	Order No.	Lead-free
10	39373-0010	Yes
11	39373-0011	
12	39373-0012	

12.00mm (.472") Pitch Beau™ EuroMax™ Pluggable PCB Terminal Blocks High-Power

39421 Horizontal Plug

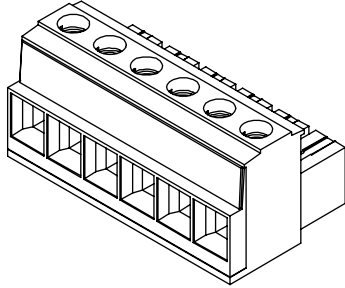

Features and Benefits

- EuroMax is Molex's highest power pluggable Eurostyle terminal block
- Unique high-power pluggable design only available from Molex
- Pluggable design allows for easy servicing and replacement in the field
- Rising cage clamp termination provides gas-tight connection without strand damage or intermittence

Reference Information

Packaging: Tray
 UL File No.: E48521
 Flammability: UL 94V-0
 Designed In: Inches
 Mates With: 39425 PCB headers

Electrical

Voltage: 600V
 Current: 85.0A
 Insulation Resistance: 5,000 Megohms min.

Mechanical

Recommended Tightening Torque: 2.70Nm (24 in.-lbs)

Physical

Housing: PBT, black
 Terminal: Copper Alloy
 Cage Clamp: Brass
 Screw: Stainless Steel, M5
 Plating: Terminal Area—Tin
 Cage Clamp—Nickel
 Screw—Tin
 Wire Range: 3 to 14 AWG
 Operating Temperature: -40 to +130°C

Circuits	Order No.	Lead-free
2	39421-0002	Yes
3	39421-0003	
4	39421-0004	
5	39421-0005	
6	39421-0006	
7	39421-0007	
8	39421-0008	
9	39421-0009	
10	39421-0010	

12.00mm (.472") Pitch Beau™ EuroMax™ Pluggable PCB Terminal Blocks High-Power

39425

Horizontal PCB Header

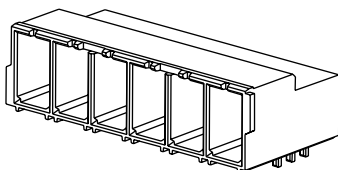

Features and Benefits

- EuroMax is Molex's highest power pluggable Eurostyle terminal block
- Unique high-power pluggable design only available from Molex
- Unique high-power pluggable design only available from Molex
- Pluggable design allows for easy servicing and replacement in the field
- Header blade has 3 PCB board tails which provide a robust connection to the PCB

Reference Information

Packaging: Tray
UL File No.: E48521
Flammability: UL 94V-0
Mates With: 39421
Designed In: Inches

Electrical

Voltage: 600V
Current: 85.0A
Insulation Resistance: 5,000 Megohms min.

Physical

Housing: PBT, black
Terminal: Brass
Plating: Terminal Area—Tin
Operating Temperature: -40 to +130°C

Circuits	Order No.	Lead-free
2	39425-0002	Yes
3	39425-0003	
4	39425-0004	
5	39425-0005	
6	39425-0006	
7	39425-0007	
8	39425-0008	
9	39425-0009	
10	39425-0010	

12.00mm (.472") Pitch Beau™ EuroMax™ Pluggable PCB Terminal Blocks High-Power

39422

Horizontal Plug With Retention Screws

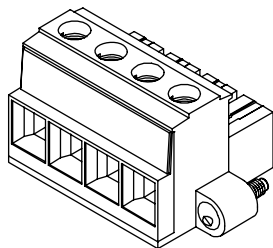

Features and Benefits

- EuroMax is Molex's highest power pluggable Eurostyle terminal block
- Unique high-power pluggable design only available from Molex
- Pluggable design allows for easy servicing and replacement in the field
- Rising cage clamp termination provides gas-tight connection without strand damage or intermittence

Reference Information

Packaging: Tray
UL File No.: E48521
Flammability: UL 94V-0
Designed In: Inches
Mates With: 39426

Electrical

Voltage: 600V
Current: 85.0A
Insulation Resistance: 5,000 Megohms min.

Mechanical

Recommended Tightening Torque: 2.70Nm (24 in.-lb)

Physical

Housing: PBT, black
Terminal: Copper Alloy
Cage Clamp: Brass
Screw: Stainless Steel, M5
Plating: Terminal Area—Tin
Cage Clamp—Nickel
Screw—Tin
Wire Range: 3 to 14 AWG
Operating Temperature: -40 to +130°C

Circuits	Order No.	Lead-free
2	39422-0002	Yes
3	39422-0003	
4	39422-0004	
5	39422-0005	
6	39422-0006	
7	39422-0007	
8	39422-0008	

12.00mm (.472") Pitch Beau™ EuroMax™ Pluggable PCB Terminal Blocks High-Power

39426

Horizontal PCB Header With Threaded Retention Inserts

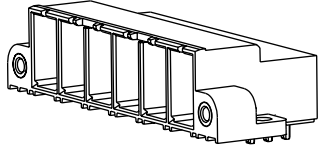

Circuits	Order No.	Lead-free
2	39426-0002	Yes
3	39426-0003	
4	39426-0004	
5	39426-0005	
6	39426-0006	
7	39426-0007	
8	39426-0008	

Features and Benefits

- EuroMax is Molex's highest power pluggable Eurostyle terminal block
- Unique high-power pluggable design only available from Molex
- Pluggable design allows for easy servicing and replacement in the field
- Header blade has three PC board tails which provide a robust connection to the PCB

Reference Information

Packaging: Tray
UL File No.: E48521
Flammability: UL 94V-0
Designed In: Inches
Mates With: 39422

Electrical

Voltage: 600V
Current: 85.0A
Insulation Resistance: 5,000 Megohms min.

Physical

Housing: PBT, black
Terminal: Brass
Plating: Terminal Area—Tin
Operating Temperature: -40 to +130°C

3.50mm (.138") Pitch Beau™ Eurostyle™ Fixed Mount PCB Terminal Blocks

39357

Vertical, Low Profile

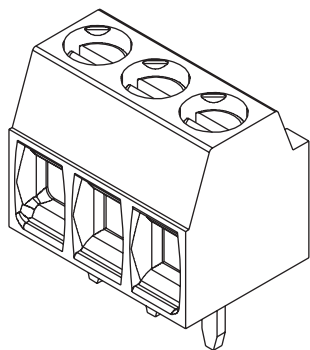

Features and Benefits

- Small footprint conserves PCB real estate and provides higher density
- Rising cage clamp termination provides gas-tight connection without strand damage or intermittence
- Molded to length design prevents awkward and time consuming dovetailing to configure larger circuits

Reference Information

Packaging: Box
UL File No.: E48521
Flammability: UL 94V-0
Designed In: Millimeters

Electrical

Voltage: 300V
Current: 12.0A
Insulation Resistance: 500 Megohms min.

Mechanical

Recommended Tightening Torque: 0.31 Nm (2.7 in.-lb)

Physical

Housing: Polyamide 6/6
Terminal: Copper Alloy
Cage Clamp: Copper Alloy
Screw: Copper Alloy, M2
Plating: Terminal Area—Tin
Cage Clamp—Nickel
Screw—Nickel
Wire Range: 16 to 18 AWG
Operating Temperature: -40 to +105°C

Circuits	Order No.	Lead-free
2	39357-0002	Yes
3	39357-0003	
4	39357-0004	
5	39357-0005	
6	39357-0006	
7	39357-0007	
8	39357-0008	
9	39357-0009	

Circuits	Order No.	Lead-free
10	39357-0010	Yes
11	39357-0011	
12	39357-0012	
13	39357-0013	
14	39357-0014	
15	39357-0015	
16	39357-0016	
17	39357-0017	

Circuits	Order No.	Lead-free
18	39357-0018	Yes
19	39357-0019	
20	39357-0020	
21	39357-0021	
22	39357-0022	
23	39357-0023	
24	39357-0024	
25	39357-0025	

5.00mm (.197") Pitch ESE Fixed Mount PCB Terminal Blocks

39543

Vertical with Rising Cage Clamp

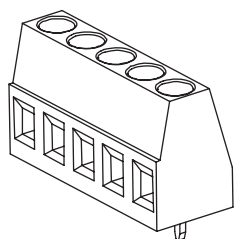

Features and Benefits

- Two optional styles of imprinting make identifying, testing and wiring easier in the field
- Captive screws mean that screws will not back out of housing

Reference Information

Packaging: Tray
UL File No.: E48521
Designed In: Inches

Electrical

Voltage: 300V
Current: 15.0A
Insulation Resistance: 500 Megohms min.

Mechanical

Recommended Tightening Torque: 0.45Nm (4 in.-lb)

Physical

Housing: Polyamide 6/6, black
Terminal: Brass
Cage Clamp: Brass
Screw: Steel, M3
Plating: Terminal Area—Tin
Cage Clamp—Nickel
Screw—Zinc
Wire Range: 12 to 30 AWG
Operating Temperature: -40 to +115°C

Circuits	Order No.	Lead-free
2	39543-3002	Yes
3	39543-3003	
4	39543-3004	
5	39543-3005	
6	39543-3006	
7	39543-3007	
8	39543-3008	
9	39543-3009	

Circuits	Order No.	Lead-free
10	39543-3010	Yes
11	39543-3011	
12	39543-3012	
13	39543-3013	
14	39543-3014	
15	39543-3015	
16	39543-3016	
17	39543-3017	

Circuits	Order No.	Lead-free
18	39543-3018	Yes
19	39543-3019	
20	39543-3020	
21	39543-3021	
22	39543-3022	
23	39543-3023	
24	39543-3024	

Note: Standard 10A (1, 2, 3...) and reverse 11A (3, 2, 1...) imprinting available.
Please refer to sales drawing for additional order numbers (available on the web).

5.00mm (.197") Pitch Beau™ Eurostyle™ Fixed Mount PCB Terminal Blocks Modular

39890

Vertical, Low Profile

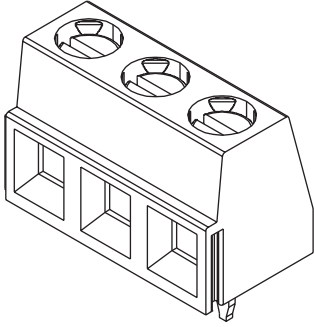

Features and Benefits

- Low profile design conserves space
- High reliability rising clamp ensures quality termination without strand damage
- Modular design allows multiple sections to be locked together to form larger assemblies to reduce inventory

Reference Information

Packaging: Box
UL File: E48521
Flammability: UL 94V-0
Designed In: Millimeters

Electrical

Voltage: 300V
Current: 13.5A
Insulation Resistance: 500 Megohms min.

Mechanical

Recommended Tightening Torque: 0.68Nm (6.0 in.-lb.)

Physical

Housing: Polyamide 6/6, black
Terminal: Copper Alloy
Screw: Copper Alloy, M3
Cage Clamp: Copper Alloy
Plating: Terminal—Tin
Screw—Nickel
Cage Clamp—Nickel
Wire Range: 16 to 30 AWG
Operating Temperature: -40°C to +105°C

Circuits	Order No.	Lead-free
2	39890-0302	Yes
3	39890-0303	
4	39890-0304	
5	39890-0305	
6	39890-0306	
7	39890-0307	
8	39890-0308	
9	39890-0309	
10	39890-0310	
11	39890-0311	
12	39890-0312	
13	39890-0313	

Circuits	Order No.	Lead-free
14	39890-0314	Yes
15	39890-0315	
16	39890-0316	
17	39890-0317	
18	39890-0318	
19	39890-0319	
20	39890-0320	
21	39890-0321	
22	39890-0322	
23	39890-0323	
24	39890-0324	
25	39890-0325	

5.00mm (.197") Pitch ESE Fixed Mount PCB Terminal Blocks

39543

Vertical with Pressure Clamp

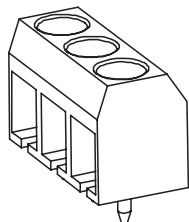

Features and Benefits

- Two optional styles of imprinting make identifying, testing and wiring easier in the field
- Captive screws mean that screws will not back out of housing

Reference Information

Packaging: Tray
UL File No.: E48521
Designed In: Inches

Electrical

Voltage: 300V
Current: 15.0A
Insulation Resistance: 500 Megohms min.

Mechanical

Recommended Tightening Torque: 0.23Nm (2 in.-lb)

Physical

Housing: Polyamide 6/6, black
Terminal: Brass
Screw: Steel, M3
Pressure Clamp: Brass
Plating: Terminal Area—Tin
Pressure Clamp—Nickel
Screw—Zinc
Wire Range: 14 to 22 AWG
Operating Temperature: -40 to +115°C

Circuits	Order No.	Lead-free
2	39543-0002	Yes
3	39543-0003	
4	39543-0004	
5	39543-0005	
6	39543-0006	
7	39543-0007	
8	39543-0008	
9	39543-0009	

Circuits	Order No.	Lead-free
10	39543-0010	Yes
11	39543-0011	
12	39543-0012	
13	39543-0013	
14	39543-0014	
15	39543-0015	
16	39543-0016	
17	39543-0017	

Circuits	Order No.	Lead-free
18	39543-0018	Yes
19	39543-0019	
20	39543-0020	
21	39543-0021	
22	39543-0022	
23	39543-0023	
24	39543-0024	

Note: Standard 10A (1, 2, 3...) and reverse 11A (3, 2, 1...) imprinting available.
Please refer to sales drawing for additional order numbers (available on the web).

5.00mm (.197") Pitch ESE Fixed Mount PCB Terminal Blocks

39543

Low Profile, Vertical with Pressure Clamp

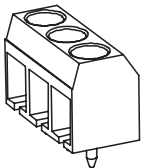

Features and Benefits

- Low profile design conserves space
- Two optional styles of imprinting make identifying, testing and wiring easier in the field
- Captive screws mean that screws will not back out of housing

Reference Information

Packaging: Tray
UL File No.: E48521
Designed In: Inches

Electrical

Voltage: 300V
Current: 15.0A
Insulation Resistance: 500 Megohms min.

Mechanical

Recommended Tightening Torque: 0.23Nm (2 in.-lb)

Physical

Housing: Polyamide 6/6, black
Terminal: Brass
Pressure Clamp: Brass
Screw: Steel, M2.5
Plating: Terminal Area—Tin
Pressure Clamp—Nickel
Screw—Zinc
Wire Range: 14 to 22 AWG
Operating Temperature: -40 to +115°C

Circuits	Order No.	Lead-free
2	39543-0602	Yes
3	39543-0603	
4	39543-0604	
5	39543-0605	
6	39543-0606	
7	39543-0607	
8	39543-0608	
9	39543-0609	

Circuits	Order No.	Lead-free
10	39543-0610	Yes
11	39543-0611	
12	39543-0612	
13	39543-0613	
14	39543-0614	
15	39543-0615	
16	39543-0616	
17	39543-0617	

Circuits	Order No.	Lead-free
18	39543-0618	Yes
19	39543-0619	
20	39543-0620	
21	39543-0621	
22	39543-0622	
23	39543-0623	
24	39543-0624	

Note: Standard 10A (1, 2, 3...) and reverse 11A (3, 2, 1...) imprinting available.
Please refer to sales drawing for additional order numbers (available on the web).

5.00mm (.197") Pitch ESE Fixed Mount PCB Terminal Blocks

39543

45° Angle with Rising Cage Clamp

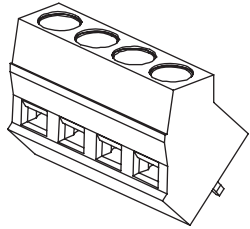

Features and Benefits

- Angled wire entry makes wiring more convenient on a crowded board
- Two optional styles of imprinting make identifying, testing and wiring easier in the field
- Captive screws mean that screws will not back out of housing

Reference Information

Packaging: Tray
UL File No.: E48521
Designed In: Inches

Electrical

Voltage: 300V
Current: 15.0A
Insulation Resistance: 500 Megohms min.

Mechanical

Recommended Tightening Torque: 0.23Nm (2 in.-lb)

Physical

Housing: Polyamide 6/6, black
Terminal: Brass
Cage Clamp: Brass
Screw: Steel, M3
Plating: Terminal Area—Tin
Cage Clamp—Nickel
Screw—Zinc
Wire Range: 14 to 22 AWG
Operating Temperature: -40 to +115°C

Circuits	Order No.	Lead-free
2	39543-4302	Yes
3	39543-4303	
4	39543-4304	
5	39543-4305	
6	39543-4306	
7	39543-4307	
8	39543-4308	
9	39543-4309	

Circuits	Order No.	Lead-free
10	39543-4310	Yes
11	39543-4311	
12	39543-4312	
13	39543-4313	
14	39543-4314	
15	39543-4315	
16	39543-4316	
17	39543-4317	

Circuits	Order No.	Lead-free
18	39543-4318	Yes
19	39543-4319	
20	39543-4320	
21	39543-4321	
22	39543-4322	
23	39543-4323	
24	39543-4324	

Note: Standard 10A (1, 2, 3...) and reverse 11A (3, 2, 1...) imprinting available. Please refer to sales drawing for additional order numbers (available on the web).

5.00mm (.197") Pitch ESE Fixed Mount PCB Terminal Blocks

39543

45° Angle, Modular with Pressure Clamp

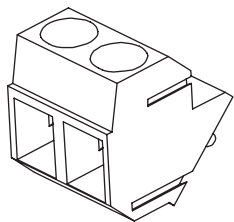

Features and Benefits

- Two optional styles of imprinting make identifying, testing and wiring easier in the field
- Captive screws mean that screws will not back out of housing

Reference Information

Packaging: Tray
UL File No.: E48521
Designed In: Inches

Electrical

Voltage: 300V
Current: 15.0A
Insulation Resistance: 500 Megohms min.

Mechanical

Recommended Tightening Torque: 0.23Nm (2 in.-lb)

Physical

Housing: Polyamide 6/6, black
Terminal: Brass
Pressure Clamp: Brass
Screw: Steel, M2.5
Plating: Terminal Area—Tin
Pressure Clamp—Nickel
Screw—Zinc
Wire Range: 14 to 22 AWG
Operating Temperature: -40 to +115°C

Circuits	Order No.	Lead-free
2	39543-0202	Yes
3	39543-0203	
4	39543-0204	
5	39543-0205	
6	39543-0206	
7	39543-0207	
8	39543-0208	
9	39543-0209	

Circuits	Order No.	Lead-free
10	39543-0210	Yes
11	39543-0211	
12	39543-0212	
13	39543-0213	
14	39543-0214	
15	39543-0215	
16	39543-0216	
17	39543-0217	

Circuits	Order No.	Lead-free
18	39543-0218	Yes
19	39543-0219	
20	39543-0220	
21	39543-0221	
22	39543-0222	
23	39543-0223	
24	39543-0224	

Note: Standard 10A (1, 2, 3...) and reverse 11A (3, 2, 1...) imprinting available. Please refer to sales drawing for additional order numbers (available on the web).

5.00mm (.197") Pitch ESE Fixed Mount PCB Terminal Blocks

39543

Horizontal, Modular

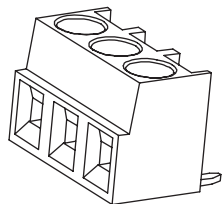

Features and Benefits

- Modular design allows multiple sections to be locked together to form larger assemblies to reduce inventory
- Two optional styles of imprinting make identifying, testing and wiring easier in the field
- Captive screws mean that screws will not back out of housing

Reference Information

Packaging: Tray
UL File No.: E48521
Designed In: Inches

Electrical

Voltage: 300V
Current: 15.0A
Insulation Resistance: 500 Megohms min.

Mechanical

Recommended Tightening Torque: 0.28Nm (2.5 in.-lb)

Physical

Housing: Polyamide 6/6, black
Terminal: Brass
Cage Clamp: Brass
Screw: Steel, M2.5
Plating: Terminal Area—Tin
Cage Clamp—Nickel
Screw—Zinc
Wire Range: 12 to 30 AWG
Operating Temperature: -40 to +115°C

Circuits	Order No.	Lead-free
2	39543-3102	Yes
3	39543-3103	
4	39543-3104	
5	39543-3105	
6	39543-3106	
7	39543-3107	
8	39543-3108	
9	39543-3109	

Circuits	Order No.	Lead-free
10	39543-3110	Yes
11	39543-3111	
12	39543-3112	
13	39543-3113	
14	39543-3114	
15	39543-3115	
16	39543-3116	
17	39543-3117	

Circuits	Order No.	Lead-free
18	39543-3118	Yes
19	39543-3119	
20	39543-3120	
21	39543-3121	
22	39543-3122	
23	39543-3123	
24	39543-3124	

Note: Standard 10A (1, 2, 3...) and reverse 11A (3, 2, 1...) imprinting available.
Please refer to sales drawing for additional order numbers (available on the web).

5.08mm (.200") Pitch ESE Fixed Mount PCB Terminal Blocks

39544

Vertical with Rising Cage Clamp

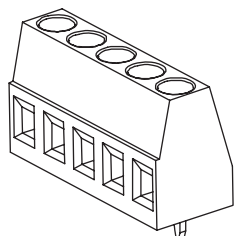

Features and Benefits

- Two optional styles of imprinting make identifying, testing and wiring easier in the field
- Captive screws mean that screws will not back out of housing

Reference Information

Packaging: Tray
UL File No.: E48521
Designed In: Inches

Electrical

Voltage: 300V
Current: 15.0A
Insulation Resistance: 500 Megohms min.

Mechanical

Recommended Tightening Torque: 0.45Nm (4 in.-lb)

Physical

Housing: Polyamide 6/6, black
Terminal: Brass
Cage Clamp: Brass
Screw: Steel, M3
Plating: Terminal Area—Tin
Cage Clamp—Nickel
Screw—Zinc
Wire Range: 12 to 30 AWG
Operating Temperature: -40 to +115°C

Circuits	Order No.	Lead-free
2	39544-3002	Yes
3	39544-3003	
4	39544-3004	
5	39544-3005	
6	39544-3006	
7	39544-3007	
8	39544-3008	
9	39544-3009	

Circuits	Order No.	Lead-free
10	39544-3010	Yes
11	39544-3011	
12	39544-3012	
13	39544-3013	
14	39544-3014	
15	39544-3015	
16	39544-3016	
17	39544-3017	

Circuits	Order No.	Lead-free
18	39544-3018	Yes
19	39544-3019	
20	39544-3020	
21	39544-3021	
22	39544-3022	
23	39544-3023	
24	39544-3024	

Note: Standard 10A (1, 2, 3...) and reverse 11A (3, 2, 1...) imprinting available.
Please refer to sales drawing for additional order numbers (available on the web).

5.08mm (.200") Pitch Beau™ Eurostyle™ Fixed Mount PCB Terminal Blocks Modular

39880
Vertical, Low Profile

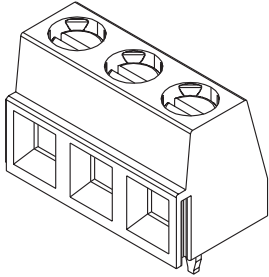

Features and Benefits

- Low profile design conserves space
- High reliability rising clamp ensures quality termination without strand damage
- Modular design allows multiple sections to be locked together to form larger assemblies to reduce inventory

Reference Information

Packaging: Box
UL File: E48521
Flammability: UL 94V-0
Designed In: Millimeters

Electrical

Voltage: 300V
Current: 13.5A
Insulation Resistance: 500 Megohms min.

Mechanical

Recommended Tightening Torque: 0.68Nm (6.0 in.-lb.)

Physical

Housing: Polyamide 6/6, black
Terminal: Copper Alloy
Screw: Copper Alloy, M3
Cage Clamp: Copper Alloy
Plating: Terminal—Tin
Screw—Nickel
Cage Clamp—Nickel
Wire Range: 16 to 30 AWG
Operating Temperature: -40°C to +105°C

Circuits	Order No.	Lead-free
2	39880-0302	Yes
3	39880-0303	
4	39880-0304	
5	39880-0305	
6	39880-0306	Yes
7	39880-0307	
8	39880-0308	
9	39880-0309	

Circuits	Order No.	Lead-free
10	39880-0310	
11	39880-0311	
12	39880-0312	
13	39880-0313	
14	39880-0314	Yes
15	39880-0315	
16	39880-0316	
17	39880-0317	

Circuits	Order No.	Lead-free
18	39880-0318	
19	39880-0319	
20	39880-0320	
21	39880-0321	
22	39880-0322	
23	39880-0323	
24	39880-0324	
25	39880-0325	

5.08mm (.200") Pitch Beau™ Eurostyle™ Fixed Mount PCB Terminal Blocks Modular

39880
35° Wire Entry

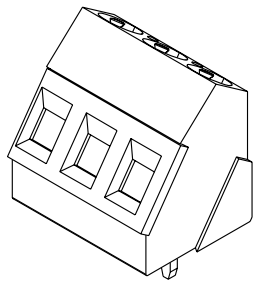

Features and Benefits

- High reliability rising clamp ensures quality termination without strand damage
- Modular design allows multiple sections to be locked together to form larger assemblies to reduce inventory
- Angled wire entry makes wiring more convenient on a crowded board

Reference Information

Packaging: Box
UL File: E48521
Flammability: UL 94V-0
Designed In: Millimeters

Electrical

Voltage: 300V
Maximum Current: 17.5A
Insulation Resistance: 500 Megohms min.

Mechanical

Recommended Tightening Torque: 0.79Nm (7.0 in.-lb.)

Physical

Housing: Polyamide 6/6, black
Terminal: Copper Alloy
Screw: Copper Alloy, M3
Cage Clamp: Copper Alloy
Plating: Terminal—Tin
Screw—Nickel
Cage Clamp—Nickel
Wire Range: 12 to 30 AWG
Operating Temperature: -40°C to +105°C

Circuits	Order No.	Lead-free
2	39880-0402	Yes
3	39880-0403	
4	39880-0404	
5	39880-0405	
6	39880-0406	
7	39880-0407	
8	39880-0408	
9	39880-0409	

Circuits	Order No.	Lead-free
10	39880-0410	
11	39880-0411	
12	39880-0412	
13	39880-0413	
14	39880-0414	Yes
15	39880-0415	
16	39880-0416	
17	39880-0417	

Circuits	Order No.	Lead-free
18	39880-0418	
19	39880-0419	
20	39880-0420	
21	39880-0421	
22	39880-0422	
23	39880-0423	
24	39880-0424	
25	39880-0425	

5.08mm (.200") Pitch Eurostyle Fixed Mount Terminal Block

39880
Horizontal

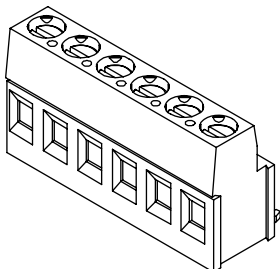

Features and Benefits

- One of our most popular pitch sizes
- Rising cage clamp termination provides gas-tight connection without strand damage or intermittence

Reference Information

Packaging: Bag
UL File No.: E48521
Designed In: Millimeters

Electrical

Voltage: 300V
Current: 17.5A
Insulation Resistance: 1000 Megohms min.

Mechanical

Recommended Tightening Torque: 0.50Nm (4.4 in. lb)

Physical

Housing: Polyamide 6/6
Terminal: Copper Alloy
Cage Clamp: Copper Alloy
Screw: Copper Alloy, M3
Plating: Terminal Area—Tin
Cage Clamp—Nickel
Screw—Nickel
Wire Range: 12 to 30 AWG
Operating Temperature: -40 to +105°C

Circuits	Order No.	Lead-free	Circuits	Order No.	Lead-free
2	39880-1202	Yes	14	39880-1214	Yes
3	39880-1203		15	39880-1215	
4	39880-1204		16	39880-1216	
5	39880-1205		17	39880-1217	
6	39880-1206		18	39880-1218	
7	39880-1207		19	39880-1219	
8	39880-1208		20	39880-1220	
9	39880-1209		21	39880-1221	
10	39880-1210		22	39880-1222	
11	39880-1211		23	39880-1223	
12	39880-1212		24	39880-1224	
13	39880-1213		25	39880-1225	

6.35mm (.250") Pitch Beau™ Eurostyle™ Fixed Mount PCB Terminal Blocks High Power

39380
Vertical

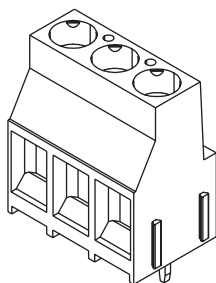

Features and Benefits

- Dovetail feature allows larger circuit sizes to be easily assembled
- Small footprint conserves PCB real estate and provides higher density
- Rising cage clamp termination provides gas-tight connection without strand damage or intermittence

Reference Information

Packaging: Box
UL File No.: E48521
Flammability: UL 94V-0
Designed In: Millimeters

Electrical

Voltage: 300V
Current: 30.0A
Insulation Resistance: 500 Megohms min.

Mechanical

Recommended Tightening Torque: 0.79Nm (7 in.-lb)

Physical

Housing: Polyamide 6/6
Terminal: Copper Alloy
Cage Clamp: Copper Alloy
Screw: Copper Alloy, M3.5
Plating: Terminal Area—Tin
Cage Clamp—Nickel
Screw—Nickel
Wire Range: 10 to 30 AWG
Operating Temperature: -40 to +105°C

Circuits	Order No.	Lead-free
2	39380-0102	Yes
3	39380-0103	

8.00 mm (.315") Pitch Beau™ Eurostyle™ Fixed Mount PCB Terminal Blocks High Power

39950 Vertical

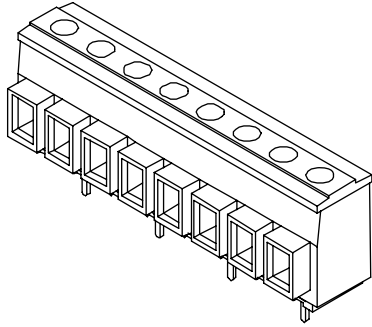

Features and Benefits

- 39950 and 39960 are the smallest pitch 600V rated Eurostyle terminal blocks available from Molex
- Extended wire entry funnel surrounds the wire insulator to eliminate exposed wire strands and reduce possible shorting
- Rising cage clamp holds wires for secure, reliable contact

Reference Information

UL File No.: E48521
Flammability: UL 94V-0

Electrical

Voltage: 600V
Current: 20.0A
Insulation Resistance: 5,000 Gigohms min.

Mechanical

Recommended Tightening Torque: 0.56Nm (5.0 in-lb.)

Physical

Housing: PBT, black
Terminal: Brass
Screw: Steel, M3
Cage Clamp: Brass
Plating: Terminal—Tin
Screw—Zinc with clear chromate
Cage Clamp—Nickel
Wire Range: 12 to 22 AWG
Operating Temperature: -40°C to +130°C

Circuit	Order No.	Lead-free
3	39950-0103	Yes
4	39950-0104	
5	39950-0105	
6	39950-0106	
7	39950-0107	

Circuit	Order No.	Lead-free
8	39950-0108	Yes
9	39950-0109	
10	39950-0110	
11	39950-0111	
12	39950-0112	

Circuit	Order No.	Lead-free
13	39950-0113	Yes
14	39950-0114	
15	39950-0115	
16	39950-0116	

8.00 mm (.315") Pitch Beau™ Eurostyle™ Fixed Mount PCB Terminal Blocks High Power

39960
Vertical

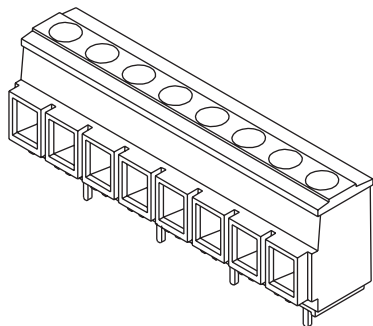

Features and Benefits

- 39960 and 39950 are the smallest pitch 600V rated Eurostyle terminal blocks available from Molex
- Extended wire entry funnel surrounds the wire insulator to eliminate exposed wire strands and reduce possible shorting
- Rising cage clamp holds wires for secure, reliable contact

Reference Information

Packaging: Tray
UL File No.: E48521
Flammability: UL 94V-0

Electrical

Voltage: 600V
Current: 30.0A
Insulation Resistance: 5,000 Gigohms min.

Mechanical

Recommended Tightening Torque: 0.79Nm (7.0 in.-lb.)

Physical

Housing: PBT, black
Terminal: Brass
Screw: Bronze, M3.5
Cage Clamp: Brass
Plating: Terminal—Tin
Screw—Tin
Cage Clamp—Nickel
Wire Range: 10 to 22 AWG
Operating Temperature: -40°C to +130°C

Circuit	Order No.	Lead-free
3	39960-0103	Yes
4	39960-0104	
5	39960-0105	
6	39960-0106	

Circuit	Order No.	Lead-free
7	39960-0107	Yes
8	39960-0108	
9	39960-0109	
10	39960-0110	

Circuit	Order No.	Lead-free
11	39960-0111	Yes
12	39960-0112	

8.00mm (.315") Pitch Beau™ Eurostyle™ Fixed Mount PCB Terminal Blocks High Power

39960
Horizontal

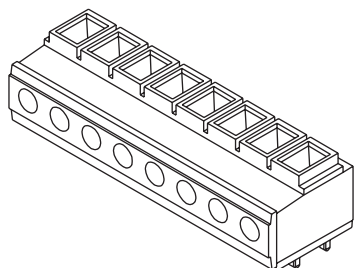

Features and Benefits

- Extended wire entry funnel surrounds the wire insulator, eliminating exposed wire strands and possible shorting
- Rising cage clamp termination provides gas-tight connection without strand damage or intermittence

Reference Information

Packaging: Tray
UL File No.: E48521
Flammability: UL 94V-0
Designed In: Inches

Electrical

Voltage: 300V
Current: 30.0A
Insulation Resistance: 5,000 Gigohms min.

Mechanical

Recommended Tightening Torque: 0.79Nm (7 in.-lb)

Physical

Housing: Polysulfone
Contact: Brass
Cage Clamp: Brass
Screw: Bronze, M3.5
Plating: Terminal Area—Tin
Cage Clamp—Nickel
Screw—Tin
Wire Range: 10 to 22 AWG
Operating Temperature: -40 to +130°C

Circuits	Order No.	Lead-free
2	39960-0202	Yes
3	39960-0203	
4	39960-0204	
5	39960-0205	
6	39960-0206	

Circuits	Order No.	Lead-free
7	39960-0207	Yes
8	39960-0208	
9	39960-0209	
10	39960-0210	
11	39960-0211	

Circuits	Order No.	Lead-free
12	39960-0212	Yes
13	39960-0213	
14	39960-0214	
15	39960-0215	
16	39960-0216	

9.53mm (.375") Pitch Beau™ Eurostyle™ Fixed Mount PCB Terminal Blocks High Power

39390
Vertical

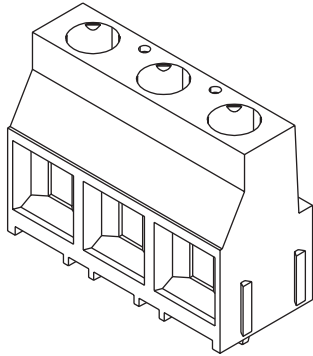

Circuits	Order No.	Lead-free
2	39390-0102	Yes
3	39390-0103	

Features and Benefits

- Dovetail feature allows larger circuit sizes to be easily assembled
- Rising cage clamp termination provides gas-tight connection without strand damage or intermittence

Reference Information

Packaging: Tray
UL File No.: E48521
Flammability: UL 94V-0
Designed In: Inches

Electrical

Voltage: 600V
Current: 30.0A
Insulation Resistance: 500 Megohms min.

Mechanical

Recommended Tightening Torque: 0.79Nm (7 in.-lbs)

Physical

Housing: Polyamide 6/6
Terminal: Copper Alloy
Cage Clamp: Copper Alloy
Screw: Copper Alloy, M3.5
Plating: Terminal Area—Tin
Cage Clamp—Nickel
Screw—Nickel
Wire Range: 10 to 30 AWG
Operating Temperature: -40 to +105°C

www.molex.com/product/euro_tb.html

10.16mm (.400") Pitch Beau™ Eurostyle™ Fixed Mount PCB Terminal Blocks High Power

39910
Vertical

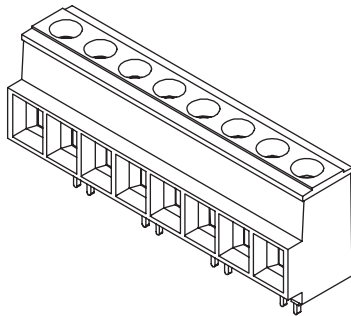

Circuits	Order No.		Lead-free
	60.0 Amp	40.0 Amp	
2	39910-0102	39910-0302	Yes
3	39910-0103	39910-0303	
4	39910-0104	39910-0304	
5	39910-0105	39910-0305	
6	39910-0106	39910-0306	
7	39910-0107	39910-0307	
8	39910-0108	39910-0308	

Features and Benefits

- Extended wire entry funnel surrounds the wire insulator to eliminate exposed wire strands and reduce possible shorting
- Highest power density of any Molex Eurostyle terminal block
- Two pins per circuit PCB terminals distribute power reducing hot spots
- Rising cage clamp holds wires for secure, reliable contact

Reference Information

Packaging: Tray
UL File No.: E48521
Flammability: UL 94V-0

Electrical

Voltage: 600V
Current: 60.0A—39910-01XX
40.0A—39910-03XX
Insulation Resistance: 50,000 Gigohms min.

Mechanical

Recommended Tightening Torque: 1.36Nm (12.0 in.-lb.)

Physical

Housing: PBT, black
Terminal: Copper
Screw: Bronze, M4
Cage Clamp: Brass
Plating: Terminal—Tin
Screw—Tin
Cage Clamp—Nickel
Wire Range: 6 to 18 AWG
Operating Temperature: -40°C to +130°C

Circuits	Order No.		Lead-free
	60.0 Amp	40.0 Amp	
9	39910-0109	39910-0309	Yes
10	39910-0110	39910-0310	
11	39910-0111	39910-0311	
12	39910-0112	39910-0312	
13	39910-0113	39910-0313	
14	39910-0114	39910-0314	

10.16 mm (.400") Pitch Beau™ Eurostyle™ Fixed Mount PCB Terminal Blocks High Power

39970
Vertical

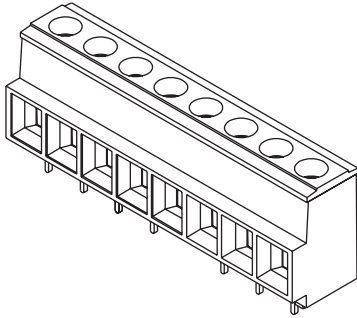

Features and Benefits

- Common pin layout for easy design in or drop-in replacement
- Extended wire entry funnel surrounds the wire insulator to eliminate exposed wire strands and reduce possible shorting
- Rising cage clamp holds wires for secure, reliable contact

Reference Information

Packaging: Tray
UL File No.: E48521
Flammability: UL 94V-0

Electrical

Voltage: 300V
Current: 60.0A—39970-01XX
40.0A—39970-03XX
Insulation Resistance: 5,000 Gigohms min.

Mechanical

Recommended Tightening Torque: 1.36Nm (12.0 in-lb.)

Physical

Housing: PBT, black
Terminal: Copper
Screw: Bronze, M4
Cage Clamp: Brass
Plating: Terminal—Tin
Screw—Tin
Cage Clamp—Nickel
Wire Range: 6 to 18 AWG
Operating Temperature: -40°C to +130°C

Circuits	Order No.		Lead-free
	60.0 Amp	40.0 Amp	
2	39970-0102	39970-0302	Yes
3	39970-0103	39970-0303	
4	39970-0104	39970-0304	
5	39970-0105	39970-0305	
6	39970-0106	39970-0306	
7	39970-0107	39970-0307	
8	39970-0108	39970-0308	

Circuits	Order No.		Lead-free
	60.0 Amp	40.0 Amp	
9	39970-0109	39970-0309	Yes
10	39970-0110	39970-0310	
11	39970-0111	39970-0311	
12	39970-0112	39970-0312	
13	39970-0113	39970-0313	
14	39970-0114	39970-0314	

15.00mm (.591") Pitch Beau™ Eurostyle™ Fixed Mount PCB Terminal Blocks High Power

39920
Vertical

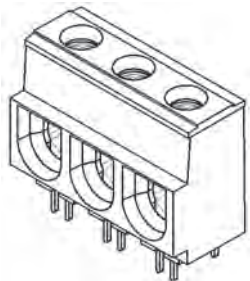

Features and Benefits

- 39920 has the highest current and voltage rating of any Molex Eurostyle terminal block
- Four pins per circuit PCB terminals distribute power reducing hot spots
- Extended wire entry funnel surrounds the wire insulator to eliminate exposed wire strands and reduce possible shorting
- Rising cage clamp holds wires for secure, reliable contact

Reference Information

Packaging: Tray
UL File: E48521
Flammability: UL 94V-0

Electrical

Voltage: 600V
Maximum Current: 115.0A
Insulation Resistance: 50,000 Gigohms min.

Mechanical

Recommended Tightening Torque: 3.95Nm (35.0 in.-lb.)

Physical

Housing: PBT, black
Terminal: Copper
Screw: Bronze, 1/4-28
Cage Clamp: Brass
Plating: Terminal—Tin
Screw—Tin
Cage Clamp—Nickel
Wire Range: 1 to 8 AWG
Operating Temperature: -40°C to +130°C

Circuits	Order No.	Lead-free
2	39920-0302	
3	39920-0303	
4	39920-0304	
5	39920-0305	

Circuits	Order No.	Lead-free
6	39920-0306	
7	39920-0307	
8	39920-0308	
9	39920-0309	

Circuits	Order No.	Lead-free
10	39920-0310	
11	39920-0311	
12	39920-0312	

15.00mm (.591") Pitch Beau™ Eurostyle™ Fixed Mount PCB Terminal Blocks High Power

39920
Vertical

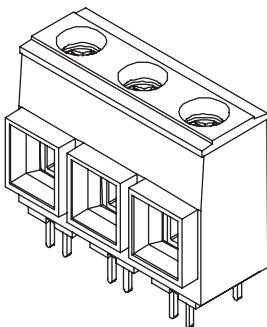

Features and Benefits

- 39920 has the highest current and voltage rating of any Molex Eurostyle terminal block
- Four pins per circuit PCB terminals distribute power reducing hot spots
- Extended wire entry funnel surrounds the wire insulator to eliminate exposed wire strands and reduce possible shorting
- Rising cage clamp holds wires for secure, reliable contact

Reference Information

Packaging: Tray
UL File: E48521
Flammability: UL 94V-0

Electrical

Voltage: 600V
Maximum Current: 100.0A
Insulation Resistance: 50,000 Gigohms min.

Mechanical

Recommended Tightening Torque: 2.71Nm (24.0 in.-lb.)

Physical

Housing: PBT, black
Terminal: Copper
Screw: Stainless Steel, M5
Cage Clamp: Brass
Plating: Terminal—Tin
Screw—Tin
Cage Clamp—Nickel
Wire Range: 3 to 14 AWG
Operating Temperature: -40°C to +130°C

Circuits	Order No.	Lead-free
2	39920-0502	Yes
3	39920-0503	
4	39920-0504	
5	39920-0505	

Circuits	Order No.	Lead-free
6	39920-0506	Yes
7	39920-0507	
8	39920-0508	
9	39920-0509	

Circuits	Order No.	Lead-free
10	39920-0510	Yes
11	39920-0511	
12	39920-0512	

5.00mm (.197") Pitch Beau™ Eurostyle™ Fixed Mount PCB Terminal Blocks Dual Level, Modular

39890

Vertical, Low Profile

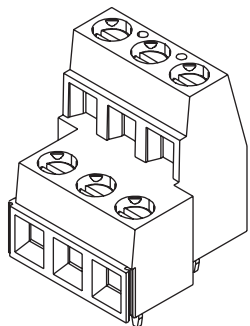

Features and Benefits

- Rising cage clamp holds wires for secure, reliable contact
- Modular design allows multiple sections to be locked together to form larger assemblies to reduce inventory
- Offset circuits provide easy accessibility and good visibility for wiring

Reference Information

Packaging: Box
UL File: E48521
Flammability: UL 94V-0
Designed In: Millimeters

Electrical

Voltage: 300V
Current: 13.5A
Insulation Resistance: 500 Megohms min.

Mechanical

Recommended Tightening Torque: 0.68Nm (6.0 in.-lb.)

Physical

Housing: Polyamide 6/6, black
Terminal: Copper Alloy
Screw: Copper Alloy, M3
Cage Clamp: Copper Alloy
Plating: Terminal—Tin
Screw—Nickel
Cage Clamp—Nickel
Wire Range: 16 to 30 AWG
Operating Temperature: -40°C to +105°C

Circuits	Order No.	Lead-free
4	39890-0504	Yes
6	39890-0506	
8	39890-0508	
10	39890-0510	
12	39890-0512	
14	39890-0514	
16	39890-0516	
18	39890-0518	

Circuits	Order No.	Lead-free
20	39890-0520	Yes
22	39890-0522	
24	39890-0524	
26	39890-0526	
28	39890-0528	
30	39890-0530	
32	39890-0532	
34	39890-0534	

Circuits	Order No.	Lead-free
36	39890-0536	Yes
38	39890-0538	
40	39890-0540	
42	39890-0542	
44	39890-0544	
46	39890-0546	
48	39890-0548	

5.00mm (.197") Pitch Beau™ Eurostyle™ Fixed Mount PCB Terminal Blocks Dual Level, Modular

39890

Vertical, Medium Profile

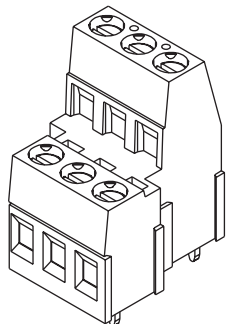

Features and Benefits

- Rising cage clamp holds wires for secure, reliable contact
- Modular design allows multiple sections to be locked together to form larger assemblies to reduce inventory
- Offset circuits provide easy accessibility and good visibility for wiring

Reference Information

Packaging: Box
UL File: E48521
Flammability: UL 94V-0
Designed In: Millimeters

Electrical

Voltage: 300V
Current: 17.5A
Insulation Resistance: 500 Megohms min.

Mechanical

Recommended Tightening Torque: 0.79Nm (7.0 in.-lb.)

Physical

Housing: Polyamide 6/6, black
Terminal: Copper Alloy
Screw: Copper Alloy, M3
Cage Clamp: Copper Alloy
Plating: Terminal—Tin
Screw—Nickel
Cage Clamp—Nickel
Wire Range: 12 to 30 AWG
Operating Temperature: -40°C to +105°C

Circuits	Order No.	Lead-free
4	39890-0604	Yes
6	39890-0606	
8	39890-0608	
10	39890-0610	
12	39890-0612	
14	39890-0614	
16	39890-0616	
18	39890-0618	

Circuits	Order No.	Lead-free
20	39890-0620	Yes
22	39890-0622	
24	39890-0624	
26	39890-0626	
28	39890-0628	
30	39890-0630	
32	39890-0632	
34	39890-0634	

Circuits	Order No.	Lead-free
36	39890-0636	Yes
38	39890-0638	
40	39890-0640	
42	39890-0642	
44	39890-0644	
46	39890-0646	
48	39890-0648	

5.00mm (.197") Pitch Beau™ Eurostyle™ Fixed Mount PCB Terminal Blocks Tri-Level, Modular

39890

Vertical, Low Profile

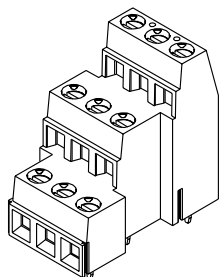

Features and Benefits

- Rising cage clamp holds wires for secure, reliable contact
- Modular design allows multiple sections to be locked together to form larger assemblies to reduce inventory
- Offset circuits provide easy accessibility and good visibility for wiring

Reference Information

Packaging: Box
UL File: E48521
Flammability: UL 94V-0
Designed In: Millimeters

Electrical

Voltage: 300V
Current: 13.5A
Insulation Resistance: 500 Megohms min.

Mechanical

Recommended Tightening Torque: 0.68Nm (6.0 in.-lb.)

Physical

Housing: Polyamide 6/6, black
Terminal: Copper Alloy
Screw: Copper Alloy, M3
Cage Clamp: Copper Alloy
Plating: Terminal—Tin
Screw—Nickel
Cage Clamp—Nickel
Wire Range: 16 to 30 AWG
Operating Temperature: -40°C to +105°C

Circuits	Order No.	Lead-free
6	39890-0806	Yes
9	39890-0809	
12	39890-0812	
15	39890-0815	
18	39890-0818	
21	39890-0821	
24	39890-0824	
27	39890-0827	

Circuits	Order No.	Lead-free
30	39890-0830	Yes
33	39890-0833	
36	39890-0836	
39	39890-0839	
42	39890-0842	
45	39890-0845	
48	39890-0848	
51	39890-0851	

Circuits	Order No.	Lead-free
54	39890-0854	Yes
57	39890-0857	
60	39890-0860	
63	39890-0863	
66	39890-0866	
69	39890-0869	
72	39890-0872	

5.00mm (.197") Pitch Beau™ Eurostyle™ Fixed Mount PCB Terminal Blocks Tri-Level, Modular

39890

Vertical, Medium Profile

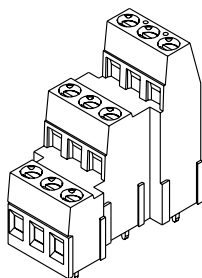

Features and Benefits

- Rising cage clamp holds wires for secure, reliable contact
- Modular design allows multiple sections to be locked together to form larger assemblies to reduce inventory
- Offset circuits provide easy accessibility and good visibility for wiring

Reference Information

Packaging: Box
UL File: E48521
Flammability: UL 94V-0
Designed In: Millimeters

Electrical

Voltage: 300V
Current: 17.5A
Insulation Resistance: 500 Megohms min.

Mechanical

Recommended Tightening Torque: 0.79Nm (7.0 in.-lb.)

Physical

Housing: Polyamide 6/6, black
Terminal: Copper Alloy
Screw: Copper Alloy, M3
Cage Clamp: Copper Alloy
Plating: Terminal—Tin
Screw—Nickel
Cage Clamp—Nickel
Wire Range: 12 to 30 AWG
Operating Temperature: -40°C to +105°C

Circuits	Order No.	Lead-free
6	39890-0906	Yes
9	39890-0909	
12	39890-0912	
15	39890-0915	
18	39890-0918	
21	39890-0921	
24	39890-0924	
27	39890-0927	

Circuits	Order No.	Lead-free
30	39890-0930	Yes
33	39890-0933	
36	39890-0936	
39	39890-0939	
42	39890-0942	
45	39890-0945	
48	39890-0948	
51	39890-0951	

Circuits	Order No.	Lead-free
54	39890-0954	Yes
57	39890-0957	
60	39890-0960	
63	39890-0963	
66	39890-0966	
69	39890-0969	
72	39890-0972	

5.08mm (.200") Pitch Beau™ Eurostyle™ Fixed Mount PCB Terminal Blocks Dual Level, Modular

39880

Vertical, Low Profile

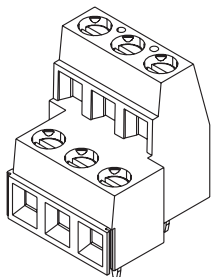

Features and Benefits

- Rising cage clamp holds wires for secure, reliable contact
- Modular design allows multiple sections to be locked together to form larger assemblies to reduce inventory
- Dual level design allows for higher density

Reference Information

Packaging: Box
UL File: E48521
Flammability: UL 94V-0
Designed In: Millimeters

Electrical

Voltage: 300V
Current: 13.5A
Insulation Resistance: 500 Megohms min.

Mechanical

Recommended Tightening Torque: 0.68Nm (6.0 in-lb.)

Physical

Housing: Polyamide 6/6, black
Terminal: Copper Alloy
Screw: Copper Alloy, M3
Cage Clamp: Copper Alloy
Plating: Terminal—Tin
Screw—Nickel
Cage Clamp—Nickel
Wire Range: 16 to 30 AWG
Operating Temperature: -40°C to +105°C

Circuits	Order No.	Lead-free
4	39880-0504	Yes
6	39880-0506	
8	39880-0508	
10	39880-0510	
12	39880-0512	
14	39880-0514	
16	39880-0516	
18	39880-0518	

Circuits	Order No.	Lead-free
20	39880-0520	Yes
22	39880-0522	
24	39880-0524	
26	39880-0526	
28	39880-0528	
30	39880-0530	
32	39880-0532	
34	39880-0534	

Circuits	Order No.	Lead-free
36	39880-0536	Yes
38	39880-0538	
40	39880-0540	
42	39880-0542	
44	39880-0544	
46	39880-0546	
48	39880-0548	

5.08mm (.200") Pitch Beau™ Eurostyle™ Fixed Mount PCB Terminal Blocks Dual Level, Modular

39880

Vertical, Medium Profile

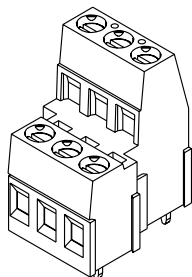

Features and Benefits

- Rising cage clamp holds wires for secure, reliable contact
- Modular design allows multiple sections to be locked together to form larger assemblies to reduce inventory
- Dual level design allows for higher density

Reference Information

Packaging: Box
UL File: E48521
Flammability: UL 94V-0
Designed In: Millimeters

Electrical

Voltage: 300V
Current: 17.5A
Insulation Resistance: 500 Megohms min.

Mechanical

Recommended Tightening Torque: 0.79Nm (7.0 in-lb.)

Physical

Housing: Polyamide 6/6, black
Terminal: Copper Alloy
Screw: Copper Alloy, M3
Cage Clamp: Copper Alloy
Plating: Terminal—Tin
Screw—Nickel
Cage Clamp—Nickel
Wire Range: 12 to 30 AWG
Operating Temperature: -40°C to +105°C

Circuits	Order No.	Lead-free
4	39880-0604	Yes
6	39880-0606	
8	39880-0608	
10	39880-0610	
12	39880-0612	
14	39880-0614	
16	39880-0616	
18	39880-0618	

Circuits	Order No.	Lead-free
20	39880-0620	Yes
22	39880-0622	
24	39880-0624	
26	39880-0626	
28	39880-0628	
30	39880-0630	
32	39880-0632	
34	39880-0634	

Circuits	Order No.	Lead-free
36	39880-0636	Yes
38	39880-0638	
40	39880-0640	
42	39880-0642	
44	39880-0644	
46	39880-0646	
48	39880-0648	

5.08mm (.200") Pitch Beau™ Eurostyle™ Fixed Mount PCB Terminal Blocks Dual Level, Modular

39880

Vertical, High Profile

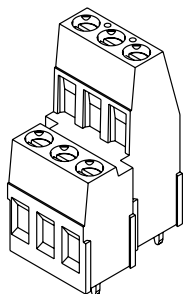

Features and Benefits

- Rising cage clamp holds wires for secure, reliable contact
- Modular design allows multiple sections to be locked together to form larger assemblies to reduce inventory
- Dual level design allows for higher density

Reference Information

Packaging: Box
UL File: E48521
Flammability: UL 94V-0
Designed In: Millimeters

Electrical

Voltage: 300V
Current: 24.0A
Insulation Resistance: 500 Megohms min.

Mechanical

Recommended Tightening Torque: 0.79Nm (7.0 in.-lb.)

Physical

Housing: Polyamide 6/6, black
Terminal: Copper Alloy
Screw: Copper Alloy, M3
Cage Clamp: Copper Alloy
Plating: Terminal—Tin
Screw—Nickel
Cage Clamp—Nickel
Wire Range: 12 to 30 AWG
Operating Temperature: -40°C to +105°C

Circuits	Order No.	Lead-free
4	39880-0704	Yes
6	39880-0706	
8	39880-0708	
10	39880-0710	
12	39880-0712	
14	39880-0714	
16	39880-0716	
18	39880-0718	

Circuits	Order No.	Lead-free
20	39880-0720	Yes
22	39880-0722	
24	39880-0724	
26	39880-0726	
28	39880-0728	
30	39880-0730	
32	39880-0732	
34	39880-0734	

Circuits	Order No.	Lead-free
36	39880-0736	Yes
38	39880-0738	
40	39880-0740	
42	39880-0742	
44	39880-0744	
46	39880-0746	
48	39880-0748	

5.08mm (.200") Pitch Beau™ Eurostyle™ Fixed Mount PCB Terminal Blocks Tri-Level, Modular

39880

Vertical, Low Profile

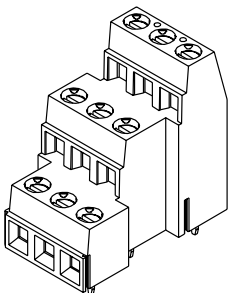

Features and Benefits

- Rising cage clamp holds wires for secure, reliable contact
- Modular design allows multiple sections to be locked together to form larger assemblies to reduce inventory
- Tri-level design allows for higher density

Reference Information

Packaging: Box
UL File: E48521
Flammability: UL 94V-0
Designed In: Millimeters

Electrical

Voltage: 300V
Current: 13.5A
Insulation Resistance: 500 Megohms min.

Mechanical

Recommended Tightening Torque: 0.68Nm (6.0 in.-lb.)

Physical

Housing: Polyamide 6/6, black
Terminal: Copper Alloy
Screw: Copper Alloy, M3
Cage Clamp: Copper Alloy
Plating: Terminal—Tin
Screw—Nickel
Cage Clamp—Nickel
Wire Range: 16 to 30 AWG
Operating Temperature: -40°C to +105°C

Circuits	Order No.	Lead-free
6	39880-0806	Yes
9	39880-0809	
12	39880-0812	
15	39880-0815	
18	39880-0818	
21	39880-0821	
24	39880-0824	
27	39880-0827	

Circuits	Order No.	Lead-free
30	39880-0830	Yes
33	39880-0833	
36	39880-0836	
39	39880-0839	
42	39880-0842	
45	39880-0845	
48	39880-0848	
51	39880-0851	

Circuits	Order No.	Lead-free
54	39880-0854	Yes
57	39880-0857	
60	39880-0860	
63	39880-0863	
66	39880-0866	
69	39880-0869	
72	39880-0872	

5.08mm (.200") Pitch Beau™ Eurostyle™ Fixed Mount PCB Terminal Blocks Tri-Level, Modular

39880

Vertical, Medium Profile

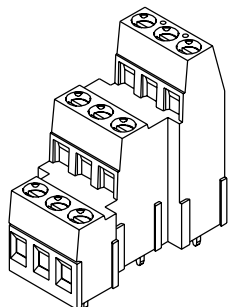

Features and Benefits

- Rising cage clamp holds wires for secure, reliable contact
- Modular design allows multiple sections to be locked together to form larger assemblies to reduce inventory
- Tri-level design allows for higher density

Reference Information

Packaging: B0x
UL File: E48521
Flammability: UL 94V-0
Designed In: Millimeters

Electrical

Voltage: 300V
Current: 17.5A
Insulation Resistance: 500 Megohms min.

Mechanical

Recommended Tightening Torque: 0.79Nm (7.0 in-lb.)

Physical

Housing: Polyamide 6/6, black
Terminal: Copper Alloy
Screw: Copper Alloy, M3
Cage Clamp: Copper Alloy
Plating: Terminal—Tin
Screw—Nickel
Cage Clamp—Nickel
Wire Range: 12 to 30 AWG
Operating Temperature: -40°C to +105°C

Circuits	Order No.	Lead-free
6	39880-0906	Yes
9	39880-0909	
12	39880-0912	
15	39880-0915	
18	39880-0918	
21	39880-0921	
24	39880-0924	
27	39880-0927	

Circuits	Order No.	Lead-free
30	39880-0930	Yes
33	39880-0933	
36	39880-0936	
39	39880-0939	
42	39880-0942	
45	39880-0945	
48	39880-0948	
51	39880-0951	

Circuits	Order No.	Lead-free
54	39880-0954	Yes
57	39880-0957	
60	39880-0960	
63	39880-0963	
66	39880-0966	
69	39880-0969	
72	39880-0972	

5.08mm (.200") Pitch Beau™ Eurostyle™ Fixed Mount PCB Terminal Blocks Tri-Level, Modular

39880

Vertical, High Profile

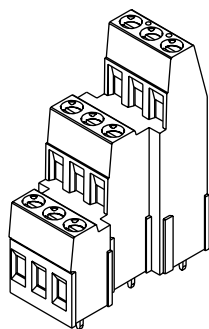

Features and Benefits

- Rising cage clamp holds wires for secure, reliable contact
- Modular design allows multiple sections to be locked together to form larger assemblies to reduce inventory
- Tri-level design allows for higher density

Reference Information

Packaging: Box
UL File: E48521
Flammability: UL 94V-0
Designed In: Millimeters

Electrical

Voltage: 300V
Current: 24.0A
Insulation Resistance: 500 Megohms min.

Mechanical

Recommended Tightening Torque: 0.79Nm (7.0 in-lb.)

Physical

Housing: Polyamide 6/6, black
Terminal: Copper Alloy
Screw: Copper Alloy, M3
Cage Clamp: Copper Alloy
Plating: Terminal—Tin
Screw—Nickel
Cage Clamp—Nickel
Wire Range: 12 to 30 AWG
Operating Temperature: -40°C to +105°C

Circuits	Order No.	Lead-free
6	39880-1006	Yes
9	39880-1009	
12	39880-1012	
15	39880-1015	
18	39880-1018	
21	39880-1021	
24	39880-1024	
27	39880-1027	

Circuits	Order No.	Lead-free
30	39880-1030	Yes
33	39880-1033	
36	39880-1036	
39	39880-1039	
42	39880-1042	
45	39880-1045	
48	39880-1048	
51	39880-1051	

Circuits	Order No.	Lead-free
54	39880-1054	Yes
57	39880-1057	
60	39880-1060	
63	39880-1063	
66	39880-1066	
69	39880-1069	
72	39880-1072	

8.00mm (.315") Pitch Two-Screw Terminal Strips

39100 Panel Mount

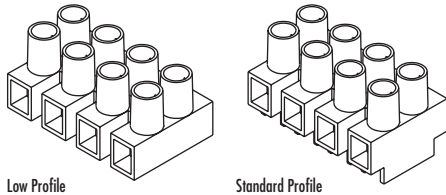

Low Profile

Standard Profile

Features and Benefits

- Modular design allows larger blocks to be easily cut to smaller circuit sizes
- Easy installation saves time and money
- Contacts and screws are recessed within the housing to help avoid short circuits
- Wire protectors prevent wire damage during connection
- Also known as "Eurostrips" or Europa Terminal blocks

Reference Information

Packaging: Bag
UL File No.: E48521
Flammability: UL 94V-2
Designed In: Millimeters

Electrical

Voltage: Standard Profile—600V
Low Profile—300V
Current: 20.0A
Insulation Resistance: 5000 Megohms min.

Mechanical

Recommended Tightening Torque: 0.50Nm (4.4 in.-lb)

Physical

Housing: Polyamide 6/6, natural color
Terminal: Brass
Wire Protector: Brass
Screw: Steel, M2
Plating: Terminal Area—Nickel
Wire Protector—Nickel
Screw—Zinc
Wire Range: 12 to 22 AWG
Operating Temperature: -40 to +105°C

Circuits	Order No.		Lead-free
	Standard Profile (with standoffs)	Low Profile (without standoffs)	
2	39100-0802	39100-0902	Yes
3	39100-0803	39100-0903	
4	39100-0804	39100-0904	
5	39100-0805	39100-0905	
6	39100-0806	39100-0906	
7	39100-0807	39100-0907	

Circuits	Order No.		Lead-free
	Standard Profile (with standoffs)	Low Profile (without standoffs)	
8	39100-0808	39100-0908	Yes
9	39100-0809	39100-0909	
10	39100-0810	39100-0910	
11	39100-0811	39100-0911	
12	39100-0812	39100-0912	

10.00mm (.394") Pitch Two-Screw Terminal Strips

39100 Panel Mount

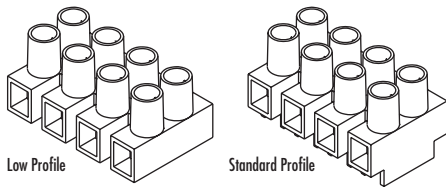

Low Profile

Standard Profile

Features and Benefits

- Modular design allows larger blocks to be easily cut to smaller circuit sizes
- Easy installation saves time and money
- Contacts and screws are recessed within the housing to help avoid short circuits
- Wire protectors prevent wire damage during connection
- Also known as "Eurostrips" or Europa Terminal blocks

Reference Information

Packaging: Bag
UL File No.: E48521
Flammability: UL 94V-2
Designed In: Millimeters

Electrical

Voltage: Standard Profile—600V
Low Profile—300V
Current: 30.0A
Insulation Resistance: 5000 Megohms min.

Mechanical

Recommended Tightening Torque: 0.79Nm (7 in.-lb)

Physical

Housing: Polyamide 6/6, natural color
Terminal: Brass
Wire Protector: Brass
Screw: Steel, M3
Plating: Terminal Area—Nickel
Wire Protector—Nickel
Screw—Zinc
Wire Range: 10 to 18 AWG
Operating Temperature: -40 to +105°C

Circuits	Order No.		Lead-free
	Standard Profile (with standoffs)	Low Profile (without standoffs)	
2	39100-1002	39100-1102	Yes
3	39100-1003	39100-1103	
4	39100-1004	39100-1104	
5	39100-1005	39100-1105	
6	39100-1006	39100-1106	
7	39100-1007	39100-1107	

Circuits	Order No.		Lead-free
	Standard Profile (with standoffs)	Low Profile (without standoffs)	
8	39100-1008	39100-1108	Yes
9	39100-1009	39100-1109	
10	39100-1010	39100-1110	
11	39100-1011	39100-1111	
12	39100-1012	39100-1112	

12.00mm (.472") Pitch Two-Screw Terminal Strips

39100
Panel Mount

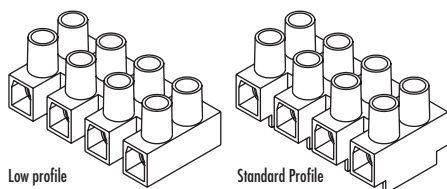

Low profile

Standard Profile

Features and Benefits

- Modular design allows larger blocks to be easily cut to smaller circuit sizes
- Easy installation saves time and money
- Contacts and screws are recessed within the housing to help avoid short circuits
- Wire protectors prevent wire damage during connection
- Also known as "Eurostrips" or Europa Terminal blocks

Reference Information

Packaging: Bag
UL File No.: E48521
Flammability: UL 94V-2
Designed In: Millimeters

Electrical

Voltage: Standard Profile—600V
Low Profile—300V
Current: 40.0A
Insulation Resistance: 5000 Megohms min.

Mechanical

Recommended Tightening Torque: 0.79Nm (7 in.-lbs)

Physical

Housing: Polyamide 6/6, natural color
Terminal: Brass
Wire Protector: Brass
Screw: Steel, M3.5
Plating: Terminal Area—Nickel
Wire Protector—Nickel
Screw—Zinc
Wire Range: 8 to 20 AWG
Operating Temperature: -40 to +105°C

Circuits	Order No.		Lead-free
	Standard Profile (with standoffs)	Low Profile (without standoffs)	
2	39100-1202	39100-1302	Yes
3	39100-1203	39100-1303	
4	39100-1204	39100-1304	
5	39100-1205	39100-1305	
6	39100-1206	39100-1306	
7	39100-1207	39100-1307	

Circuits	Order No.		Lead-free
	Standard Profile (with standoffs)	Low Profile (without standoffs)	
8	39100-1208	39100-1308	Yes
9	39100-1209	39100-1309	
10	39100-1210	39100-1310	
11	39100-1211	39100-1311	
12	39100-1212	39100-1312	

15.00mm (.591") Pitch Two-Screw Terminal Strip

39100
Panel Mount

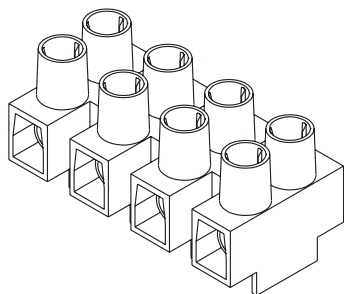

Features and Benefits

- Modular design allows larger blocks to be easily cut to smaller circuit sizes
- Easy installation saves time and money
- Contacts and screws are recessed within the housing to help avoid short circuits
- Wire protectors prevent wire damage during connection
- Also known as "Eurostrips" or Europa Terminal blocks

Reference Information

Packaging: Bag
UL File No.: E48521
Flammability: UL 94V-2
Designed In: Inches

Electrical

Voltage: 600V
Current: 63.0A
Insulation Resistance: 5000 Megohms min.

Mechanical

Recommended Tightening Torque: 2.26Nm (20 in.-lb)

Physical

Housing: Polyamide 6/6, natural color
Contact: Brass
Wire Protector: Brass
Screw: Steel, M5
Plating: Contact Area—Nickel
Wire Protector—Nickel
Screw—Zinc
Wire Range: 6 to 14 AWG
Operating Temperature: -40 to +105°C

Circuits	Order No.	Lead-free
2	39100-1502	Yes
3	39100-1503	
4	39100-1504	
5	39100-1505	
6	39100-1506	
7	39100-1507	

Circuits	Order No.	Lead-free
8	39100-1508	Yes
9	39100-1509	
10	39100-1510	
11	39100-1511	
12	39100-1512	

6.35mm (.250") Pitch Beau™ Barrier Terminal Strips

38610 PC Terminal

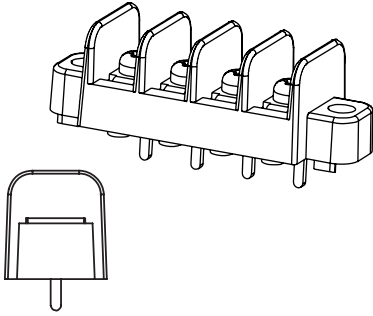

Features and Benefits

- Smallest footprint available conserves PCB real estate and provides higher density
- Molded from thermoplastic which is less brittle than Phenolic
- Phillips/slotted combo head screws mean these parts are easy to install and don't require any special tools

Reference Information

Packaging: Tray
UL File No.: E48521
Flammability: UL 94V-0
Designed In: Inches

Electrical

Voltage: 250V
Current: 10.0A
Dielectric Withstanding Voltage: 1600V AC
Insulation Resistance: 1000 Megohms min.

Mechanical

Recommended Tightening Torque: 0.34Nm (3 in.-lb)

Physical

Housing: PBT, black
Terminal: Brass
Screw: Brass, #3-48, Phillips/Slot combo head
Plating: Terminal Area—Tin
Screw—Nickel
Wire Range: 18 to 22 AWG
Operating Temperature: -40° to +130°C

Circuits	Order No.		Lead-free
	With Mounting Ends	Without Mounting Ends	
2	38610-6402	38610-6602	Yes
3	38610-6403	38610-6603	
4	38610-6404	38610-6604	
5	38610-6405	38610-6605	
6	38610-6406	38610-6606	
7	38610-6407	38610-6607	
8	38610-6408	38610-6608	
9	38610-6409	38610-6609	
10	38610-6410	38610-6610	
11	38610-6411	38610-6611	
12	38610-6412	38610-6612	
13	38610-6413	38610-6613	
14	38610-6414	38610-6614	
15	38610-6415	38610-6615	
16	38610-6416	38610-6616	

Circuits	Order No.		Lead-free
	With Mounting Ends	Without Mounting Ends	
17	38610-6417	38610-6617	Yes
18	38610-6418	38610-6618	
19	38610-6419	38610-6619	
20	38610-6420	38610-6620	
21	38610-6421	38610-6621	
22	38610-6422	38610-6622	
23	38610-6423	38610-6623	
24	38610-6424	38610-6624	
25	38610-6425	38610-6625	
26	38610-6426	38610-6626	
27	38610-6427	38610-6627	
28	38610-6428	38610-6628	
29	38610-6429	38610-6629	
30	38610-6430	38610-6630	
31	38610-6431	38610-6631	
32	38610-6432	38610-6632	

8.26mm (.325") Pitch Beau™ Barrier Terminal Strips

38700
PC Terminal

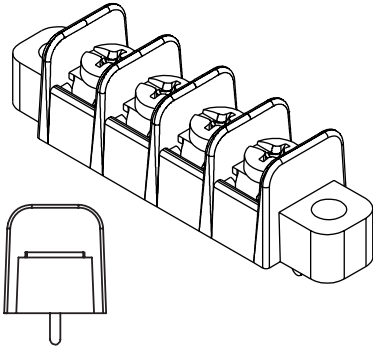

Features and Benefits

- Our most popular style of barrier strip, can be used in a wide variety of applications
- Molded from thermoplastic which is less brittle than Phenolic
- Optional Mounting ends ensure parts are securely mounted to the PCB
- Phillips/slotted combo head screws mean these parts are easy to install and don't require any special tooling

Reference Information

Packaging: Tray
UL File No.: E48521
Flammability: UL 94V-0
Designed In: Inches

Electrical

Voltage: 300V
Current: 15.0A
Dielectric Withstanding Voltage: 1600V AC
Insulation Resistance: 1000 Megohms min.

Mechanical

Recommended Tightening Torque: 1.36Nm (12 in.-lb)

Physical

Housing: PBT, black
Terminal: Brass
Screw: Steel, #6-32, Phillips/Slot combo head
Plating: Terminal Area—Tin
Screw—Zinc with clear chromate
Wire Range: 14 to 22 AWG
Operating Temperature: -40° to +110°C

Circuits	Order No.		Lead-free
	With Mounting Ends	Without Mounting Ends	
2	38700-6102	38700-6302	Yes
3	38700-6103	38700-6303	
4	38700-6104	38700-6304	
5	38700-6105	38700-6305	
6	38700-6106	38700-6306	
7	38700-6107	38700-6307	
8	38700-6108	38700-6308	
9	38700-6109	38700-6309	
10	38700-6110	38700-6310	
11	38700-6111	38700-6311	
12	38700-6112	38700-6312	
13	38700-6113	38700-6313	
14	38700-6114	38700-6314	

Circuits	Order No.		Lead-free
	With Mounting Ends	Without Mounting Ends	
15	38700-6115	38700-6315	Yes
16	38700-6116	38700-6316	
17	38700-6117	38700-6317	
18	38700-6118	38700-6318	
19	38700-6119	38700-6319	
20	38700-6120	38700-6320	
21	38700-6121	38700-6321	
22	38700-6122	38700-6322	
23	38700-6123	38700-6323	
24	38700-6124	38700-6324	
25	38700-6125	38700-6325	
26	38700-6126	38700-6326	

8.26mm (.325") Pitch Beau™ Tri-Barrier Terminal Strips 38704 PC Terminal

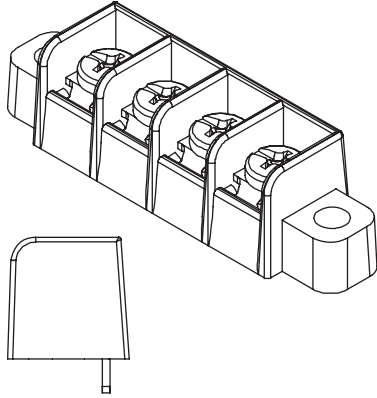

Features and Benefits

- One of our most popular pitch sizes
- Tri-barrier construction prevents short circuits and improves isolation allowing other components to be placed close to the strip to conserve board space
- Mounting ends ensure parts are securely mounted to the PCB
- Molded from thermoplastic which is less brittle than Phenolic
- Phillips/slotted combo head screws mean these parts are easy to install and don't require any special tooling

Reference Information

Packaging: Tray
UL File No.: E48521
Flammability: UL 94V-0
Designed In: Inches

Electrical

Voltage: 300V
Current: 15.0A
Dielectric Withstanding Voltage: 1600V AC
Insulation Resistance: 1000 Megohms min.

Mechanical

Recommended Tightening Torque: 1.36Nm (12 in.-lb)

Physical

Housing: PBT, black
Terminal: Brass
Screw: Steel, #6-32, Phillips/Slot combo head
Plating: Terminal Area—Tin
Screw—Zinc with clear chromate
Wire Range: 14 to 22 AWG
Operating Temperature: -40° to +110°C

Circuits	Order No.		Lead-free
	With Mounting Ends	Without Mounting Ends	
2	38704-4002	38704-4102	Yes
3	38704-4003	38704-4102	
4	38704-4004	38704-4102	
5	38704-4005	38704-4102	
6	38704-4006	38704-4102	
7	38704-4007	38704-4102	

Circuits	Order No.		Lead-free
	With Mounting Ends	Without Mounting Ends	
8	38704-4008	38704-4108	Yes
9	38704-4009	38704-4109	
10	38704-4010	38704-4110	
11	38704-4011	38704-4111	
12	38704-4012	38704-4112	

8.26mm (.325") Pitch Beau™ Barrier Terminal Strips

38701 Right Angle PC Terminal

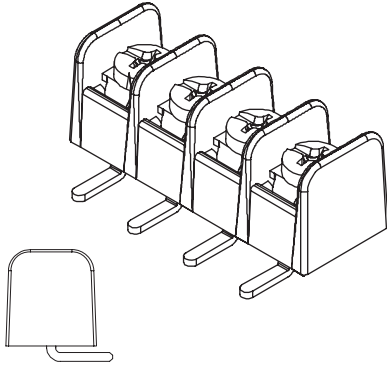

Features and Benefits

- Molded from thermoplastic which is less brittle than Phenolic resins
- One of our most popular pitch sizes

Reference Information

Packaging: Tray
UL File No.: E48521
Flammability: UL 94V-0
Designed In: Inches

Electrical

Voltage: 300V
Current: 15.0A
Dielectric Withstanding Voltage: 1600V AC
Insulation Resistance: 5000 Megohms min.

Mechanical

Recommended Tightening Torque: 1.36Nm (12 in.-lb)

Physical

Housing: PBT, black
Terminal: Brass
Screw: Steel, #6-32, Phillips/Slot combo head
Plating: Terminal Area—Tin
Screw—Zinc with clear chromate
Wire Range: 14 to 22 AWG
Operating Temperature: -40° to +110°C

Circuits	Order No.		Lead-free
	With Mounting Ends	Without Mounting Ends	
2	38701-5102	38701-5302	Yes
3	38701-5103	38701-5303	
4	38701-5104	38701-5304	
5	38701-5105	38701-5305	
6	38701-5106	38701-5306	
7	38701-5107	38701-5307	
8	38701-5108	38701-5308	
9	38701-5109	38701-5309	
10	38701-5110	38701-5310	
11	38701-5111	38701-5311	
12	38701-5112	38701-5312	
13	38701-5113	38701-5313	
14	38701-5114	38701-5314	
15	38701-5115	38701-5315	
16	38701-5116	38701-5316	
17	38701-5117	38701-5317	

Circuits	Order No.		Lead-free
	With Mounting Ends	Without Mounting Ends	
18	38701-5118	38701-5318	Yes
19	38701-5119	38701-5319	
20	38701-5120	38701-5320	
21	38701-5121	38701-5321	
22	38701-5122	38701-5322	
23	38701-5123	38701-5323	
24	38701-5124	38701-5324	
25	38701-5125	38701-5325	
26	38701-5126	38701-5326	
27	38701-5127	38701-5327	
28	38701-5128	38701-5328	
29	38701-5129	38701-5329	
30	38701-5130	38701-5330	
31	38701-5131	38701-5331	
32	38701-5132	38701-5332	

8.26mm (.325") Pitch Beau™ Barrier Terminal Strips

38701 Wire Wrap Terminal

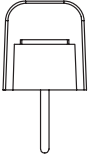
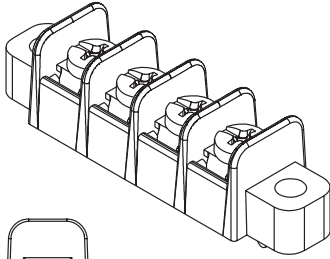

Features and Benefits

- Molded from thermoplastic which is less brittle than Phenolic resins
- One of our most popular pitch sizes

Reference Information

Packaging: Tray
UL File No.: E48521
Flammability: UL 94V-0
Designed In: Inches

Electrical

Voltage: 300V
Current: 15.0A
Dielectric Withstanding Voltage: 1600V AC
Insulation Resistance: 5000 Megohms min.

Mechanical

Recommended Tightening Torque: 1.36Nm (12 in.-lb)

Physical

Housing: PBT, black
Terminal: Brass
Screw: Steel, #6-32, Phillips/Slot combo head
Plating: Terminal Area—Tin
Screw—Zinc with clear chromate
Wire Range: 14 to 22 AWG
Operating Temperature: -40° to +110°C

Circuits	Order No.		Lead-free
	With Mounting Ends	Without Mounting Ends	
2	38701-2102	38701-2302	Yes
3	38701-2103	38701-2303	
4	38701-2104	38701-2304	
5	38701-2105	38701-2305	
6	38701-2106	38701-2306	
7	38701-2107	38701-2307	
8	38701-2108	38701-2308	
9	38701-2109	38701-2309	
10	38701-2110	38701-2310	
11	38701-2111	38701-2311	
12	38701-2112	38701-2312	
13	38701-2113	38701-2313	
14	38701-2114	38701-2314	
15	38701-2115	38701-2315	
16	38701-2116	38701-2316	
17	38701-2117	38701-2317	

Circuits	Order No.		Lead-free
	With Mounting Ends	Without Mounting Ends	
18	38701-2118	38701-2318	Yes
19	38701-2119	38701-2319	
20	38701-2120	38701-2320	
21	38701-2121	38701-2321	
22	38701-2122	38701-2322	
23	38701-2123	38701-2323	
24	38701-2124	38701-2324	
25	38701-2125	38701-2325	
26	38701-2126	38701-2326	
27	38701-2127	38701-2327	
28	38701-2128	38701-2328	
29	38701-2129	38701-2329	
30	38701-2130	38701-2330	
31	38701-2131	38701-2331	
32	38701-2132	38701-2332	

9.53mm (.375") Pitch Beau™ Barrier Terminal Strips

38710 Panel Mount

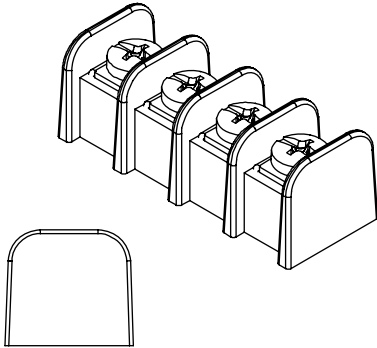

Features and Benefits

- Molded from thermoplastic which is less brittle than Phenolic resins
- Low profile design conserves space

Reference Information

Packaging: Tray
UL File No.: E48521
Flammability: UL 94V-0
Designed In: Inches

Electrical

Voltage: 300V
Current: 15.0A
Dielectric Withstanding Voltage: 1600V AC
Insulation Resistance: 5000 Megohms min.

Mechanical

Recommended Tightening Torque: 1.36Nm (12 in.-lb)

Physical

Housing: PBT, black
Terminal: Brass
Screw: Steel, #6-32, Phillips/Slot combo head
Plating: Terminal Area—Tin
Screw—Zinc with clear chromate
Wire Range: 14 to 22 AWG
Operating Temperature: -40° to +110°C

Circuits	Order No.		Lead-free
	With Mounting Ends	Without Mounting Ends	
2	38710-0202	38710-0302	Yes
3	38710-0203	38710-0303	
4	38710-0204	38710-0304	
5	38710-0205	38710-0305	
6	38710-0206	38710-0306	
7	38710-0207	38710-0307	
8	38710-0208	38710-0308	
9	38710-0209	38710-0309	
10	38710-0210	38710-0310	
11	38710-0211	38710-0311	
12	38710-0212	38710-0312	
13	38710-0213	38710-0313	
14	38710-0214	38710-0314	

Circuits	Order No.		Lead-free
	With Mounting Ends	Without Mounting Ends	
15	38710-0215	38710-0315	Yes
16	38710-0216	38710-0316	
17	38710-0217	38710-0317	
18	38710-0218	38710-0318	
19	38710-0219	38710-0319	
20	38710-0220	38710-0320	
21	38710-0221	38710-0321	
22	38710-0222	38710-0322	
23	38710-0223	38710-0323	
24	38710-0224	38710-0324	
25	38710-0225	38710-0325	
26	38710-0226	38710-0326	

9.53mm (.375") Pitch Beau™ Barrier Terminal Strips

38720 Panel Mount

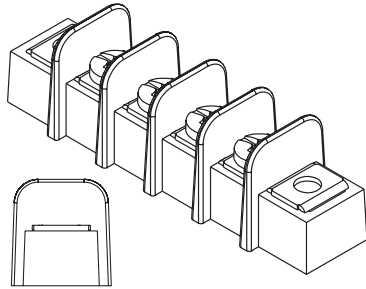

Features and Benefits

- Fast and easy to wire, no special tools required
- Molded from thermoplastic which is less brittle than Phenolic resins

Reference Information

Packaging: Tray
UL File No.: E48521
Flammability: UL 94V-0
Designed In: Inches

Electrical

Voltage: 300V
Current: 15.0A
Dielectric Withstanding Voltage: 1600V AC
Insulation Resistance: 5000 Megohms min.

Mechanical

Recommended Tightening Torque: 1.36Nm (12 in.-lb)

Physical

Housing: PBT, black
Terminal: Brass
Screw: Steel, #6-32, Phillips/Slot combo head
Plating: Terminal Area—Tin
Screw—Zinc with clear chromate
Wire Range: 14 to 22 AWG
Operating Temperature: -40° to +110°C

Circuits	Order No.		Lead-free
	With Mounting Ends	Without Mounting Ends	
2	38720-0202	38720-0302	Yes
3	38720-0203	38720-0303	
4	38720-0204	38720-0304	
5	38720-0205	38720-0305	
6	38720-0206	38720-0306	
7	38720-0207	38720-0307	
8	38720-0208	38720-0308	
9	38720-0209	38720-0309	
10	38720-0210	38720-0310	
11	38720-0211	38720-0311	
12	38720-0212	38720-0312	
13	38720-0213	38720-0313	
14	38720-0214	38720-0314	

Circuits	Order No.		Lead-free
	With Mounting Ends	Without Mounting Ends	
15	38720-0215	38720-0315	Yes
16	38720-0216	38720-0316	
17	38720-0217	38720-0317	
18	38720-0218	38720-0318	
19	38720-0219	38720-0319	
20	38720-0220	38720-0320	
21	38720-0221	38720-0321	
22	38720-0222	38720-0322	
23	38720-0223	38720-0323	
24	38720-0224	38720-0324	
25	38720-0225	38720-0325	
26	38720-0226	38720-0326	

9.53mm (.375") Pitch Beau™ Barrier Terminal Strips

38720 PC Terminal

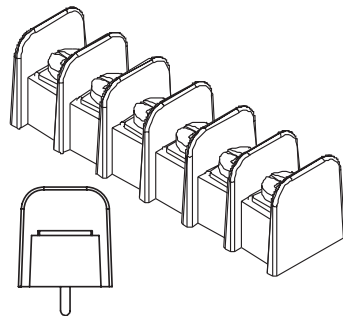

Features and Benefits

- One of our most popular pitch sizes
- Mounting ends ensure parts are securely mounted to the PCB
- Molded from thermoplastic which is less brittle than Phenolic
- Phillips/slotted combo head screws mean these parts are easy to install and don't require any special tooling

Reference Information

Packaging: Tray
UL File No.: E48521
Flammability: UL 94V-0
Designed In: Inches

Electrical

Voltage: 300V
Current: 15.0A
Dielectric Withstanding Voltage: 1600V AC
Insulation Resistance: 1000 Megohms min.

Mechanical

Recommended Tightening Torque: 1.36Nm (12 in.-lb)

Physical

Housing: PBT, black
Terminal: Brass
Screw: Steel, #6-32, Philips/Slot combo head
Plating: Terminal Area—Tin
Screw—Zinc with clear chromate
Wire Range: 14 to 22 AWG
Operating Temperature: -40° to +110°C

Circuits	Order No.		Lead-free
	With Mounting Ends	Without Mounting Ends	
2	38720-6202	38720-6302	Yes
3	38720-6203	38720-6303	
4	38720-6204	38720-6304	
5	38720-6205	38720-6305	
6	38720-6206	38720-6306	
7	38720-6207	38720-6307	
8	38720-6208	38720-6308	
9	38720-6209	38720-6309	
10	38720-6210	38720-6310	
11	38720-6211	38720-6311	
12	38720-6212	38720-6312	
13	38720-6213	38720-6313	
14	38720-6214	38720-6314	

Circuits	Order No.		Lead-free
	With Mounting Ends	Without Mounting Ends	
15	38720-6215	38720-6315	Yes
16	38720-6216	38720-6316	
17	38720-6217	38720-6317	
18	38720-6218	38720-6318	
19	38720-6219	38720-6319	
20	38720-6220	38720-6320	
21	38720-6221	38720-6321	
22	38720-6222	38720-6322	
23	38720-6223	38720-6323	
24	38720-6224	38720-6324	
25	38720-6225	38720-6325	
26	38720-6226	38720-6326	

9.53mm (.375") Pitch Beau™ Barrier Terminal Strips

38711 Right Angle PC Terminal

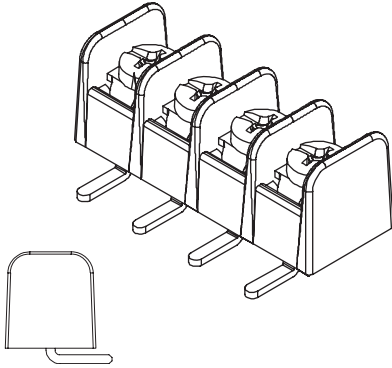

Features and Benefits

- Molded from thermoplastic which is less brittle than Phenolic resins
- Low profile design conserves space

Reference Information

Packaging: Tray
UL File No.: E48521
Flammability: UL 94V-0
Designed In: Inches

Electrical

Voltage: 300V
Current: 15.0A
Dielectric Withstanding Voltage: 1600V AC
Insulation Resistance: 5000 Megohms min.

Mechanical

Recommended Tightening Torque: 1.36Nm (12 in.-lb)

Physical

Housing: PBT, black
Terminal: Brass
Screw: Steel, #6-32, Phillips/Slot combo head
Plating: Terminal Area—Tin
Screw—Zinc with clear chromate
Wire Range: 14 to 22 AWG
Operating Temperature: -40° to +110°C

Circuits	Order No.		Lead-free
	With Mounting Ends	Without Mounting Ends	
2	38711-5202	38711-5302	Yes
3	38711-5203	38711-5303	
4	38711-5204	38711-5304	
5	38711-5205	38711-5305	
6	38711-5206	38711-5306	
7	38711-5207	38711-5307	
8	38711-5208	38711-5308	
9	38711-5209	38711-5309	
10	38711-5210	38711-5310	
11	38711-5211	38711-5311	
12	38711-5212	38711-5312	
13	38711-5213	38711-5313	
14	38711-5214	38711-5314	

Circuits	Order No.		Lead-free
	With Mounting Ends	Without Mounting Ends	
15	38711-5215	38711-5315	Yes
16	38711-5216	38711-5316	
17	38711-5217	38711-5317	
18	38711-5218	38711-5318	
19	38711-5219	38711-5319	
20	38711-5220	38711-5320	
21	38711-5221	38711-5321	
22	38711-5222	38711-5322	
23	38711-5223	38711-5323	
24	38711-5224	38711-5324	
25	38711-5225	38711-5325	
26	38711-5226	38711-5326	

9.53mm (.375") Pitch Beau™ Barrier Terminal Strips

38721 Right Angle PC Terminal

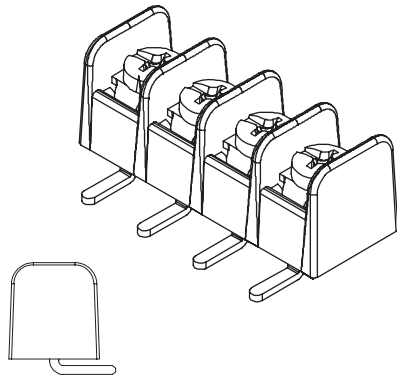

Features and Benefits

- Fast and easy to wire, no special tools required
- Molded from thermoplastic which is less brittle than Phenolic resins

Reference Information

Packaging: Tray
UL File No.: E48521
Flammability: UL 94V-0
Designed In: Inches

Electrical

Voltage: 300V
Current: 15.0A
Dielectric Withstanding Voltage: 1600V AC
Insulation Resistance: 5000 Megohms min.

Mechanical

Recommended Tightening Torque: 1.36Nm (12 in.-lb)

Physical

Housing: PBT, black
Terminal: Brass
Screw: Steel, #6-32, Phillips/Slot combo head
Plating: Terminal Area—Tin
Screw—Zinc with clear chromate
Wire Range: 14 to 22 AWG
Operating Temperature: -40° to +110°C

Circuits	Order No.		Lead-free
	With Mounting Ends	Without Mounting Ends	
2	38721-5202	38721-5302	Yes
3	38721-5203	38721-5303	
4	38721-5204	38721-5304	
5	38721-5205	38721-5305	
6	38721-5206	38721-5306	
7	38721-5207	38721-5307	
8	38721-5208	38721-5308	
9	38721-5209	38721-5309	
10	38721-5210	38721-5310	
11	38721-5211	38721-5311	
12	38721-5212	38721-5312	
13	38721-5213	38721-5313	
14	38721-5214	38721-5314	

Circuits	Order No.		Lead-free
	With Mounting Ends	Without Mounting Ends	
15	38721-5215	38721-5315	Yes
16	38721-5216	38721-5316	
17	38721-5217	38721-5317	
18	38721-5218	38721-5318	
19	38721-5219	38721-5319	
20	38721-5220	38721-5320	
21	38721-5221	38721-5321	
22	38721-5222	38721-5322	
23	38721-5223	38721-5323	
24	38721-5224	38721-5324	
25	38721-5225	38721-5325	
26	38721-5226	38721-5326	

9.53mm (.375") Pitch Beau™ Barrier Terminal Strips

38711 Wire Wrap Terminal

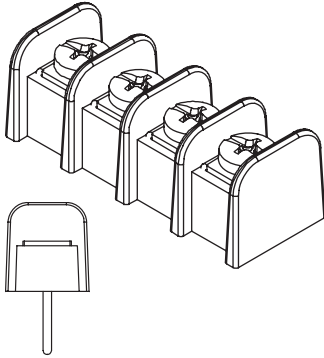

Features and Benefits

- Molded from thermoplastic which is less brittle than Phenolic resins
- Low profile design conserves space

Reference Information

Packaging: Tray
UL File No.: E48521
Flammability: UL 94V-0
Designed In: Inches

Electrical

Voltage: 300V
Current: 15.0A
Dielectric Withstanding Voltage: 1600V AC
Insulation Resistance: 5000 Megohms min.

Mechanical

Recommended Tightening Torque: 1.36Nm (12 in.-lb)

Physical

Housing: PBT, black
Terminal: Brass
Screw: Steel, #6-32, Phillips/Slot combo head
Plating: Terminal Area—Tin
Screw—Zinc with clear chromate
Wire Range: 14 to 22 AWG
Operating Temperature: -40° to +110°C

Circuits	Order No.		Lead-free
	With Mounting Ends	Without Mounting Ends	
2	38711-2202	38711-2302	Yes
3	38711-2203	38711-2303	
4	38711-2204	38711-2304	
5	38711-2205	38711-2305	
6	38711-2206	38711-2306	
7	38711-2207	38711-2307	
8	38711-2208	38711-2308	
9	38711-2209	38711-2309	
10	38711-2210	38711-2310	
11	38711-2211	38711-2311	
12	38711-2212	38711-2312	
13	38711-2213	38711-2313	
14	38711-2214	38711-2314	

Circuits	Order No.		Lead-free
	With Mounting Ends	Without Mounting Ends	
15	38711-2215	38711-2315	Yes
16	38711-2216	38711-2316	
17	38711-2217	38711-2317	
18	38711-2218	38711-2318	
19	38711-2219	38711-2319	
20	38711-2220	38711-2320	
21	38711-2221	38711-2321	
22	38711-2222	38711-2322	
23	38711-2223	38711-2323	
24	38711-2224	38711-2324	
25	38711-2225	38711-2325	
26	38711-2226	38711-2326	

9.53mm (.375") Pitch Beau™ Barrier Terminal Strips

38721 Wire Wrap Terminal

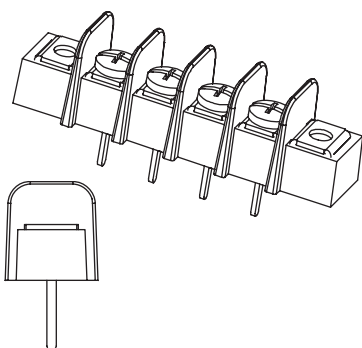

Features and Benefits

- Fast and easy to wire, no special tools required
- Molded from thermoplastic which is less brittle than Phenolic resins

Reference Information

Packaging: Tray
UL File No.: E48521
Flammability: UL 94V-0
Designed In: Inches

Electrical

Voltage: 300V
Current: 15.0A
Dielectric Withstanding Voltage: 1600V AC
Insulation Resistance: 5000 Megohms min.

Mechanical

Recommended Tightening Torque: 1.36Nm (12 in.-lb)

Physical

Housing: PBT, black
Terminal: Brass
Screw: Steel, #6-32, Phillips/Slot combo head
Plating: Terminal Area—Tin
Screw—Zinc with clear chromate
Wire Range: 14 to 22 AWG
Operating Temperature: -40° to +110°C

Circuits	Order No.		Lead-free
	With Mounting Ends	Without Mounting Ends	
2	38721-2202	38721-2302	Yes
3	38721-2203	38721-2303	
4	38721-2204	38721-2304	
5	38721-2205	38721-2305	
6	38721-2206	38721-2306	
7	38721-2207	38721-2307	
8	38721-2208	38721-2308	
9	38721-2209	38721-2309	
10	38721-2210	38721-2310	
11	38721-2211	38721-2311	
12	38721-2212	38721-2312	
13	38721-2213	38721-2313	
14	38721-2214	38721-2314	

Circuits	Order No.		Lead-free
	With Mounting Ends	Without Mounting Ends	
15	38721-2215	38721-2315	Yes
16	38721-2216	38721-2316	
17	38721-2217	38721-2317	
18	38721-2218	38721-2318	
19	38721-2219	38721-2319	
20	38721-2220	38721-2320	
21	38721-2221	38721-2321	
22	38721-2222	38721-2322	
23	38721-2223	38721-2323	
24	38721-2224	38721-2324	
25	38721-2225	38721-2325	
26	38721-2226	38721-2326	

9.53mm (.375") Pitch Beau™ Barrier Terminal Strips

38710 Insulated Solder Turret Terminal

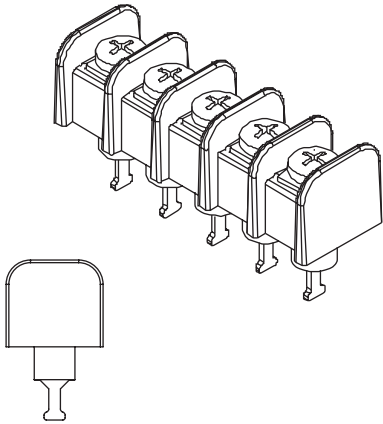

Features and Benefits

- Molded from thermoplastic which is less brittle than Phenolic resins
- Low profile design conserves space

Reference Information

Packaging: Tray
UL File No.: E48521
Flammability: UL 94V-0
Designed In: Inches

Electrical

Voltage: 300V
Current: 15.0A
Dielectric Withstanding Voltage: 1600V AC
Insulation Resistance: 5000 Megohms min.

Mechanical

Recommended Tightening Torque: 1.36Nm (12 in.-lb)

Physical

Housing: PBT, black
Terminal: Brass
Screw: Steel, #6-32, Phillips/Slot combo head
Plating: Terminal—Tin
Screw—Zinc with clear chromate
Wire Range: 14 to 22 AWG
Operating Temperature: -40° to +110°C

Circuits	Order No.		Lead-free
	With Mounting Ends	Without Mounting Ends	
2	38710-3202	38710-3302	Yes
3	38710-3203	38710-3303	
4	38710-3204	38710-3304	
5	38710-3205	38710-3305	
6	38710-3206	38710-3306	
7	38710-3207	38710-3307	
8	38710-3208	38710-3308	
9	38710-3209	38710-3309	
10	38710-3210	38710-3310	
11	38710-3211	38710-3311	
12	38710-3212	38710-3312	
13	38710-3213	38710-3313	
14	38710-3214	38710-3314	

Circuits	Order No.		Lead-free
	With Mounting Ends	Without Mounting Ends	
15	38710-3215	38710-3315	Yes
16	38710-3216	38710-3316	
17	38710-3217	38710-3317	
18	38710-3218	38710-3318	
19	38710-3219	38710-3319	
20	38710-3220	38710-3320	
21	38710-3221	38710-3321	
22	38710-3222	38710-3322	
23	38710-3223	38710-3323	
24	38710-3224	38710-3324	
25	38710-3225	38710-3325	
26	38710-3226	38710-3326	

9.53mm (.375") Pitch Beau™ Barrier Terminal Strips

38720

Insulated Solder Turret Terminal

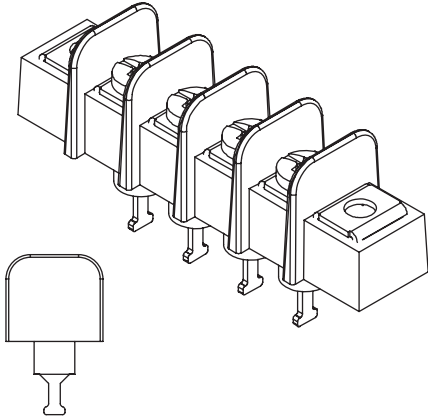

Features and Benefits

- Molded from thermoplastic which is less brittle than Phenolic resins

Reference Information

Packaging: Tray
UL File No.: E48521
Flammability: UL 94V-0
Designed In: Inches

Electrical

Voltage: 300V
Current: 25.0A
Dielectric Withstanding Voltage: 1600V AC
Insulation Resistance: 5000 Megohms min.

Mechanical

Recommended Tightening Torque: 1.36Nm (12 in.-lb)

Physical

Housing: PBT, black
Terminal: Brass
Screw: Steel, #6-32, Phillips/Slot combo head
Plating: Terminal—Tin
Screw—Zinc with clear chromate
Wire Range: 14 to 22 AWG
Operating Temperature: -40° to +110°C

Circuits	Order No.		Lead-free
	With Mounting Ends	Without Mounting Ends	
2	38720-3202	38720-3302	Yes
3	38720-3203	38720-3303	
4	38720-3204	38720-3304	
5	38720-3205	38720-3305	
6	38720-3206	38720-3306	
7	38720-3207	38720-3307	
8	38720-3208	38720-3308	
9	38720-3209	38720-3309	
10	38720-3210	38720-3310	
11	38720-3211	38720-3311	
12	38720-3212	38720-3312	
13	38720-3213	38720-3313	
14	38720-3214	38720-3314	

Circuits	Order No.		Lead-free
	With Mounting Ends	Without Mounting Ends	
15	38720-3215	38720-3315	Yes
16	38720-3216	38720-3316	
17	38720-3217	38720-3317	
18	38720-3218	38720-3318	
19	38720-3219	38720-3319	
20	38720-3220	38720-3320	
21	38720-3221	38720-3321	
22	38720-3222	38720-3322	
23	38720-3223	38720-3323	
24	38720-3224	38720-3324	
25	38720-3225	38720-3325	
26	38720-3226	38720-3326	

9.53mm (.375") Pitch Beau™ Barrier Terminal Strips

38711 Insulated Quick Connect Terminal

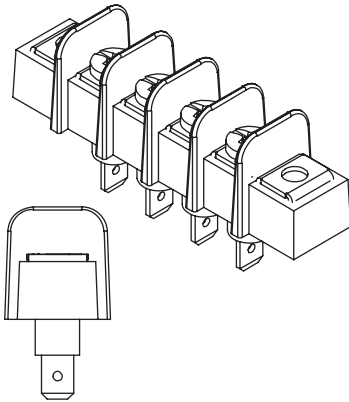

Features and Benefits

- Molded from thermoplastic which is less brittle than Phenolic resins
- Low profile design conserves space

Reference Information

Packaging: Tray
UL File No.: E48521
Flammability: UL 94V-0
Designed In: Inches

Electrical

Voltage: 300V
Current: 15.0A
Dielectric Withstanding Voltage: 1600V AC
Insulation Resistance: 5000 Megohms min.

Mechanical

Recommended Tightening Torque: 1.36Nm (12 in.-lb)

Physical

Housing: PBT, black
Terminal: Brass
Screw: Steel, #6-32, Phillips/Slot combo head
Plating: Terminal Area—Tin
Screw—Zinc with clear chromate
Wire Range: 14 to 22 AWG
Operating Temperature: -40° to +110°C

Circuits	Order No.		Lead-free
	With Mounting Ends	Without Mounting Ends	
2	38711-6702	38711-6802	Yes
3	38711-6703	38711-6803	
4	38711-6704	38711-6804	
5	38711-6705	38711-6805	
6	38711-6706	38711-6806	
7	38711-6707	38711-6807	
8	38711-6708	38711-6808	
9	38711-6709	38711-6809	
10	38711-6710	38711-6810	
11	38711-6711	38711-6811	
12	38711-6712	38711-6812	
13	38711-6713	38711-6813	
14	38711-6714	38711-6814	

Circuits	Order No.		Lead-free
	With Mounting Ends	Without Mounting Ends	
15	38711-6715	38711-6815	Yes
16	38711-6716	38711-6816	
17	38711-6717	38711-6817	
18	38711-6718	38711-6818	
19	38711-6719	38711-6819	
20	38711-6720	38711-6820	
21	38711-6721	38711-6821	
22	38711-6722	38711-6822	
23	38711-6723	38711-6823	
24	38711-6724	38711-6824	
25	38711-6725	38711-6825	
26	38711-6726	38711-6826	

9.53mm (.375") Pitch Beau™ Barrier Terminal Strips

38721 Insulated Quick Connect Terminal

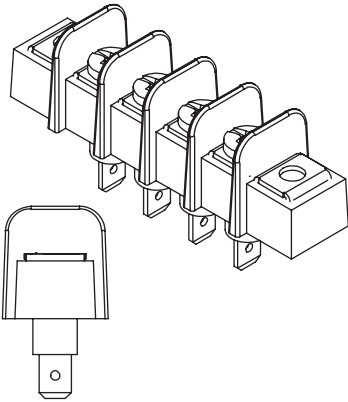

Features and Benefits

- Fast and easy to wire, no special tools required
- Molded from thermoplastic which is less brittle than Phenolic resins

Reference Information

Packaging: Tray
UL File No.: E48521
Flammability: UL 94V-0
Designed In: Inches

Electrical

Voltage: 300V
Current: 15.0A
Dielectric Withstanding Voltage: 1600V AC
Insulation Resistance: 5000 Megohms min.

Mechanical

Recommended Tightening Torque: 1.36Nm (12 in.-lb)

Physical

Housing: PBT, black
Terminal: Brass
Screw: Steel, #6-32, Phillips/Slot combo head
Plating: Terminal Area—Tin
Screw—Zinc with clear chromate
Wire Range: 14 to 22 AWG
Operating Temperature: -40° to +110°C

Circuits	Order No.		Lead-free
	With Mounting Ends	Without Mounting Ends	
2	38721-6702	38721-6802	Yes
3	38721-6703	38721-6803	
4	38721-6704	38721-6804	
5	38721-6705	38721-6805	
6	38721-6706	38721-6806	
7	38721-6707	38721-6807	
8	38721-6708	38721-6808	
9	38721-6709	38721-6809	
10	38721-6710	38721-6810	
11	38721-6711	38721-6811	
12	38721-6712	38721-6812	
13	38721-6713	38721-6813	
14	38721-6714	38721-6814	

Circuits	Order No.		Lead-free
	With Mounting Ends	Without Mounting Ends	
15	38721-6715	38721-6815	Yes
16	38721-6716	38721-6816	
17	38721-6717	38721-6817	
18	38721-6718	38721-6818	
19	38721-6719	38721-6819	
20	38721-6720	38721-6820	
21	38721-6721	38721-6821	
22	38721-6722	38721-6822	
23	38721-6723	38721-6823	
24	38721-6724	38721-6824	
25	38721-6725	38721-6825	
26	38721-6726	38721-6826	

11.11mm (.438") Pitch Beau™ Barrier Terminal Strips

38730 Panel Mount

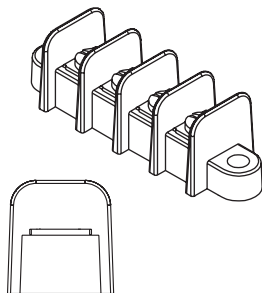

Features and Benefits

- Fast and easy to wire, no special tools required
- Molded from thermoplastic which is less brittle than Phenolic resins

Reference Information

Packaging: Tray
UL File No.: E48521
Flammability: UL 94V-0
Designed In: Inches

Electrical

Voltage: 300V
Current: 15.0A
Dielectric Withstanding Voltage: 1600V AC
Insulation Resistance: 5000 Megohms min.

Mechanical

Recommended Tightening Torque: 1.36Nm (12 in.-lb)

Physical

Housing: PBT, black
Terminal: Brass
Screw: Steel, #6-32, Phillips/Slot combo head
Plating: Terminal Area—Tin
Screw—Zinc Chromate
Wire Range: 14 to 22 AWG
Operating Temperature: -40° to +110°C

Circuits	Order No.	Lead-free
2	38730-0102	Yes
3	38730-0103	
4	38730-0104	
5	38730-0105	
6	38730-0106	
7	38730-0107	
8	38730-0108	
9	38730-0109	
10	38730-0110	

Circuits	Order No.	Lead-free
11	38730-0111	Yes
12	38730-0112	
13	38730-0113	
14	38730-0114	
15	38730-0115	
16	38730-0116	
17	38730-0117	
18	38730-0118	
19	38730-0119	

Circuits	Order No.	Lead-free
20	38730-0120	Yes
21	38730-0121	
22	38730-0122	
23	38730-0123	
24	38730-0124	
25	38730-0125	
26	38730-0126	

11.11mm (.438") Pitch Beau™ Barrier Terminal Strips

38630 Wire Wrap Terminal

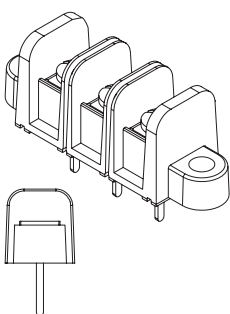

Features and Benefits

- Our smallest 600V barrier style terminal block provides high-voltage density
- Molded from thermoplastic which is less brittle than Phenolic resins

Reference Information

Packaging: Tray
UL File No.: E48521
Flammability: UL 94V-0
Designed In: Inches

Electrical

Voltage: 600V
Current: 15.0A
Dielectric Withstanding Voltage: 2200V AC
Insulation Resistance: 5000 Megohms min.

Mechanical

Recommended Tightening Torque: 1.36Nm (12 in.-lb)

Physical

Housing: PBT, black
Terminal: Brass
Screw: Steel, #6-32, Phillips/Slot combo head
Plating: Terminal Area—Tin
Screw—Bright zinc
Wire Range: 14 to 22 AWG
Operating Temperature: -40° to +110°C

Circuits	Order No.		Lead-free
	With Mounting Ends	Without Mounting Ends	
2	38631-2402	38631-2602	Yes
3	38631-2403	38631-2603	
4	38631-2404	38631-2604	
5	38631-2405	38631-2605	
6	38631-2406	38631-2606	
7	38631-2407	38631-2607	
8	38631-2408	38631-2608	
9	38631-2409	38631-2609	

Circuits	Order No.		Lead-free
	With Mounting Ends	Without Mounting Ends	
10	38631-2410	38631-2610	Yes
11	38631-2411	38631-2611	
12	38631-2412	38631-2612	
13	38631-2413	38631-2613	
14	38631-2414	38631-2614	
15	38631-2415	38631-2615	
16	38631-2416	38631-2616	

11.11mm (.438") Pitch Beau™ Barrier Terminal Strips

38730 Insulated Solder Turret Terminal

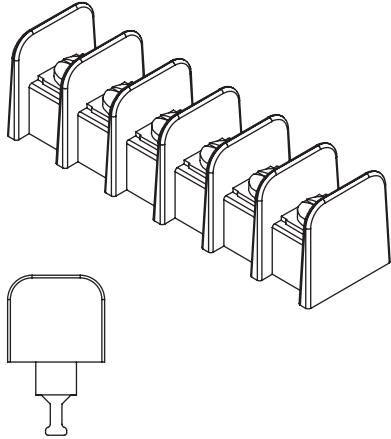

Features and Benefits

- Molded from thermoplastic which is less brittle than Phenolic resins

Reference Information

Packaging: Tray
UL File No.: E48521
Flammability: UL 94V-0
Designed In: Inches

Electrical

Voltage: 300V
Current: 15.0A
Dielectric Withstanding Voltage: 1600V AC
Insulation Resistance: 5000 Megohms min.

Mechanical

Recommended Tightening Torque: 1.36Nm (12 in.-lb)

Physical

Housing: PBT, black
Terminal: Brass
Screw: Steel, #6-32, Phillips/Slot combo head
Plating: Terminal—Tin
Screw—Zinc with clear chromate
Wire Range: 14 to 22 AWG
Operating Temperature: -40° to +110°C

Circuits	Order No.		Lead-free
	With Mounting Ends	Without Mounting Ends	
2	38730-3102	38730-3302	Yes
3	38730-3103	38730-3303	
4	38730-3104	38730-3304	
5	38730-3105	38730-3305	
6	38730-3106	38730-3306	
7	38730-3107	38730-3307	
8	38730-3108	38730-3308	
9	38730-3109	38730-3309	
10	38730-3110	38730-3310	
11	38730-3111	38730-3311	
12	38730-3112	38730-3312	
13	38730-3113	38730-3313	
14	38730-3114	38730-3314	
15	38730-3115	38730-3315	
16	38730-3116	38730-3316	

Circuits	Order No.		Lead-free
	With Mounting Ends	Without Mounting Ends	
17	38730-3117	38730-3317	Yes
18	38730-3118	38730-3318	
19	38730-3119	38730-3319	
20	38730-3120	38730-3320	
21	38730-3121	38730-3321	
22	38730-3122	38730-3322	
23	38730-3123	38730-3323	
24	38730-3124	38730-3324	
25	38730-3125	38730-3325	
26	38730-3126	38730-3326	
27	38730-3127	38730-3327	
28	38730-3128	38730-3328	
29	38730-3129	38730-3329	
30	38730-3130	38730-3330	

11.11mm (.438") Pitch Beau™ Barrier Terminal Strips

38740 Insulated Solder Turret Terminal

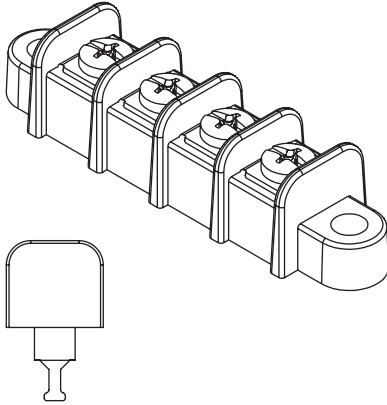

Features and Benefits

- Molded from thermoplastic which is less brittle than Phenolic resins
- Low profile design conserves space

Reference Information

Packaging: Tray
UL File No.: E48521
Flammability: UL 94V-0
Designed In: Inches

Electrical

Voltage: 300V
Current: 15.0A
Dielectric Withstanding Voltage: 1600V AC
Insulation Resistance: 5000 Megohms min.

Mechanical

Recommended Tightening Torque: 1.36Nm (12 in.-lb)

Physical

Housing: PBT, black
Terminal: Brass
Screw: Steel, #6-32, Phillips/Slot combo head
Plating: Terminal—Tin
Screw—Zinc with clear chromate
Wire Range: 14 to 22 AWG
Operating Temperature: -40° to +110°C

Circuits	Order No.		Lead-free
	With Mounting Ends	Without Mounting Ends	
2	38740-3102	38740-3302	Yes
3	38740-3103	38740-3303	
4	38740-3104	38740-3304	
5	38740-3105	38740-3305	
6	38740-3106	38740-3306	
7	38740-3107	38740-3307	
8	38740-3108	38740-3308	
9	38740-3109	38740-3309	
10	38740-3110	38740-3310	
11	38740-3111	38740-3311	
12	38740-3112	38740-3312	
13	38740-3113	38740-3313	
14	38740-3114	38740-3314	
15	38740-3115	38740-3315	
16	38740-3116	38740-3316	

Circuits	Order No.		Lead-free
	With Mounting Ends	Without Mounting Ends	
17	38740-3117	38740-3317	Yes
18	38740-3118	38740-3318	
19	38740-3119	38740-3319	
20	38740-3120	38740-3320	
21	38740-3121	38740-3321	
22	38740-3122	38740-3322	
23	38740-3123	38740-3323	
24	38740-3124	38740-3324	
25	38740-3125	38740-3325	
26	38740-3126	38740-3326	
27	38740-3127	38740-3327	
28	38740-3128	38740-3328	
29	38740-3129	38740-3329	
30	38740-3130	38740-3330	

11.11mm (.438") Pitch Beau™ Barrier Terminal Strips

38730 Insulated Quick Connect Terminal

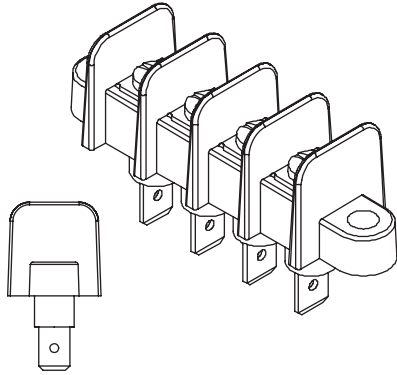

Features and Benefits

- Fast and easy to wire, no special tools required
- Molded from thermoplastic which is less brittle than Phenolic resins

Reference Information

Packaging: Tray
UL File No.: E48521
Flammability: UL 94V-0
Designed In: Inches

Electrical

Voltage: 300V
Current: 15.0A
Dielectric Withstanding Voltage: 1600V AC
Insulation Resistance: 5000 Megohms min.

Mechanical

Recommended Tightening Torque: 1.36Nm (12 in.-lb)

Physical

Housing: PBT, black
Terminal: Brass
Screw: Steel, #6-32, Phillips/Slot combo head
Plating: Terminal Area—Tin
Screw—Zinc with clear chromate
Wire Range: 14 to 22 AWG
Operating Temperature: -40° to +110°C

Circuits	Order No.		Lead-free
	With Mounting Ends	Without Mounting Ends	
2	38731-6602	38731-6802	Yes
3	38731-6603	38731-6803	
4	38731-6604	38731-6804	
5	38731-6605	38731-6805	
6	38731-6606	38731-6806	
7	38731-6607	38731-6807	
8	38731-6608	38731-6808	
9	38731-6609	38731-6809	
10	38731-6610	38731-6810	
11	38731-6611	38731-6811	
12	38731-6612	38731-6812	
13	38731-6613	38731-6813	
14	38731-6614	38731-6814	
15	38731-6615	38731-6815	
16	38731-6616	38731-6816	

Circuits	Order No.		Lead-free
	With Mounting Ends	Without Mounting Ends	
17	38731-6617	38731-6817	Yes
18	38731-6618	38731-6818	
19	38731-6619	38731-6819	
20	38731-6620	38731-6820	
21	38731-6621	38731-6821	
22	38731-6622	38731-6822	
23	38731-6623	38731-6823	
24	38731-6624	38731-6824	
25	38731-6625	38731-6825	
26	38731-6626	38731-6826	
27	38731-6627	38731-6827	
28	38731-6628	38731-6828	
29	38731-6629	38731-6829	
30	38731-6630	38731-6830	

11.11mm (.438") Pitch Beau™ Barrier Terminal Strips

38741 Insulated Quick Connect Terminal

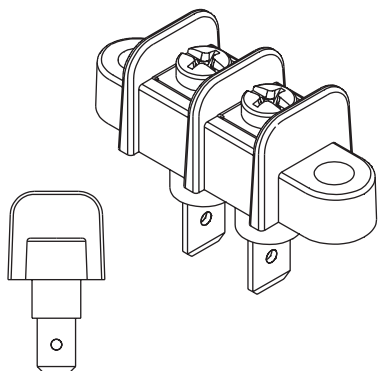

Circuits	Order No.	Lead-free
2	38741-6602	Yes
3	38741-6603	
4	38741-6604	
5	38741-6605	
6	38741-6606	
7	38741-6607	
8	38741-6608	

Features and Benefits

- Molded from thermoplastic which is less brittle than Phenolic resins
- Low profile design conserves space

Reference Information

Packaging: Tray
UL File No.: E48521
Flammability: UL 94V-0
Designed In: Inches

Electrical

Voltage: 300V
Current: 15.0A
Dielectric Withstanding Voltage: 1600V AC
Insulation Resistance: 5000 Megohms min.

Mechanical

Recommended Tightening Torque: 1.36Nm (12 in.-lb)

Physical

Housing: PBT, black
Terminal: Brass
Screw: Steel, #6-32, Phillips/Slot combo head
Plating: Terminal Area—Tin
Screw—Zinc with clear chromate
Wire Range: 14 to 22 AWG
Operating Temperature: -40° to +110°C

12.70mm (.500") Pitch TSE Tri-Barrier Terminal Strips

38969 PC Terminal

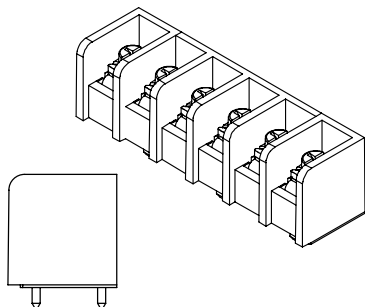

Circuits	Order No.	Lead-free
2	38969-0002	Yes
3	38969-0003	
4	38969-0004	
5	38969-0005	
6	38969-0006	
7	38969-0007	
8	38969-0008	

Features and Benefits

- Highest current and voltage rating of any Molex barrier terminal strip
- One of our most popular pitch sizes
- Tri-barrier construction prevents short circuits and improves isolation allowing other components to be placed close to the trip to conserve board space
- Molded from thermoplastic which is less brittle than Phenolic
- Phillips/slotted combo head screws mean these parts are easy to install and don't require any special tooling

Reference Information

Packaging: Tray
UL File No.: E48521
Flammability: UL 94V-0
Designed In: Inches

Electrical

Voltage: 600V
Current: 50.0A
Dielectric Withstanding Voltage: 2200V AC
Insulation Resistance: 500 Megohms min.

Mechanical

Recommended Tightening Torque: 1.81Nm (16 in. lb)

Physical

Housing: PBT, black
Terminal: Brass
Screw with Clamp Washer: Steel, M4, Phillips/Slot combo head
Plating: Terminal Area—Tin
Screw—Nickel
Wire Gauge: 8 to 20 AWG
Operating Temperature: -40° to +120°C

Circuits	Order No.	Lead-free
9	38969-0009	Yes
10	38969-0010	
11	38969-0011	
12	38969-0012	
13	38969-0013	
14	38969-0014	
15	38969-0015	

8.26mm (.325") Pitch Beau™ Barrier Terminal Strips

38706
Dual Level, PC Terminal

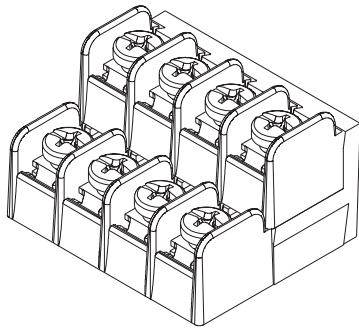

Features and Benefits

- High density barrier terminal strip exceeds 6 circuits per inch.
- Single unit construction provides the lowest installed costs.
- Low profile and small footprint conserve space.

Reference Information

Packaging: Tray
UL File No.: E48521
Flammability: UL 94V-0

Electrical

Voltage: 300V
Current: 15.0A
Insulation Resistance: 5000 Megohms min.
Dielectric Withstanding Voltage: 1600V AC

Mechanical

Recommended Tightening Torque: 1.36Nm (12 in.-lb.)
Wire Range: 14 to 22 AWG

Physical

Housing: Polysulfone, black
Terminal: Brass
Screw: Steel, #6-32, Phillips/Slot combo head
Plating: Terminal—Tin
Screw—Zinc with clear chromate
Operating Temperature: -40°C to +110°C

Circuits	Order No.	Lead-free
4	38706-0004	Yes
6	38706-0006	
8	38706-0008	
10	38706-0010	
12	38706-0012	
14	38706-0014	

Circuits	Order No.	Lead-free
16	38706-0016	Yes
18	38706-0018	
20	38706-0020	
22	38706-0022	
24	38706-0024	

9.53mm (.375") Pitch TSE Double Row Barrier Terminal Strips

38760/38770
Panel Mount

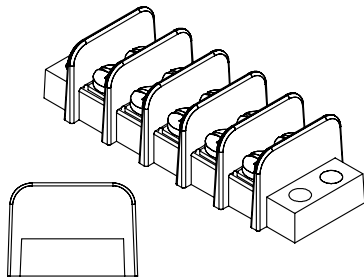

Features and Benefits

- Double row design makes wire-to-wire connections fast and easy
- Closed-bottom design allows the part to be mounted directly on a sheet metal panel or placed over a panel cutout
- Molded from thermoplastic which is less brittle than Phenolic

Reference Information

Packaging: Tray
UL File No.: E48521
Flammability: UL 94V-0
Designed In: Inches

Electrical

Voltage: 300V
Current: 15.0A
Dielectric Withstanding Voltage: 1600V AC
Insulation Resistance: 1000 Megohms min.

Mechanical

Recommended Tightening Torque: 1.26Nm (12 in.-lb.)

Physical

Housing: PBT, black
Terminal: Brass
Screw: Steel, #6-32, Phillips/Slot combo head
Plating: Terminal Area—Tin
Screw—Zinc with clear chromate
Wire Range: 14 to 22 AWG
Operating Temperature: -40° to +110°C

Circuits	Order No.		Lead-free
	Low Profile	Standard	
2	38770-0102	38760-0102	Yes
3	38770-0103	38760-0103	
4	38770-0104	38760-0104	
5	38770-0105	38760-0105	
6	38770-0106	38760-0106	
7	38770-0107	38760-0107	
8	38770-0108	38760-0108	
9	38770-0109	38760-0109	
10	38770-0110	38760-0110	
11	38770-0111	38760-0111	
12	38770-0112	38760-0112	
13	38770-0113	38760-0113	
14	38770-0114	38760-0114	
15	38770-0115	38760-0115	

Circuits	Order No.		Lead-free
	Low Profile	Standard	
16	38770-0116	38760-0116	Yes
17	38770-0117	38760-0117	
18	38770-0118	38760-0118	
19	38770-0119	38760-0119	
20	38770-0120	38760-0120	
21	38770-0121	38760-0121	
22	38770-0122	38760-0122	
23	38770-0123	38760-0123	
24	38770-0124	38760-0124	
25	38770-0125	38760-0125	
26	38770-0126	38760-0126	
27	38770-0127	38760-0127	
28	38770-0128	38760-0128	
29	38770-0129	38760-0129	
30	38770-0130	38760-0130	

11.11mm (.438") Pitch Beau™ Double Row Barrier Terminal Strips

38780

Panel Mount

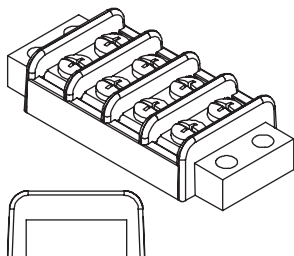

Features and Benefits

- Double row design makes wire-to-wire connections fast and easy
- Highest power density of any double row Molex barrier strip
- Molded from thermoplastic which is less brittle than Phenolic resins
- Closed-bottom design allows the part to be mounted directly on a sheet metal panel or places over a panel cutout

Reference Information

Packaging: Tray
UL File No.: E48521
Flammability: UL 94V-0
Designed In: Inches

Electrical

Voltage: 300V
Current: 15.0A
Dielectric Withstanding Voltage: 1600V AC
Insulation Resistance: 1000 Megohms min.

Mechanical

Recommended Tightening Torque: 1.36Nm (12 in.-lb)

Physical

Housing: PBT, black
Terminal: Brass
Screw: Steel, #6-32, Phillips/Slot combo head
Plating: Terminal Area—Nickel
Screw—Zinc with clear chromate
Wire Range: 14 to 22 AWG
Operating Temperature: -40° to +110°C

Circuits	Order No.	Lead-free
2	38780-0102	Yes
3	38780-0103	
4	38780-0104	
5	38780-0105	
6	38780-0106	
7	38780-0107	
8	38780-0108	
9	38780-0109	
10	38780-0110	
11	38780-0111	

Circuits	Order No.	Lead-free
12	38780-0112	Yes
13	38780-0113	
14	38780-0114	
15	38780-0115	
16	38780-0116	
17	38780-0117	
18	38780-0118	
19	38780-0119	
20	38780-0120	
21	38780-0121	

Circuits	Order No.	Lead-free
22	38780-0122	Yes
23	38780-0123	
24	38780-0124	
25	38780-0125	
26	38780-0126	
27	38780-0127	
28	38780-0128	
29	38980-1029	
30	38780-0130	

www.molex.com/product/tse.html

14.30mm (.563") Pitch Beau™ Barrier Terminal Strips Double Row

38221

Panel Mount

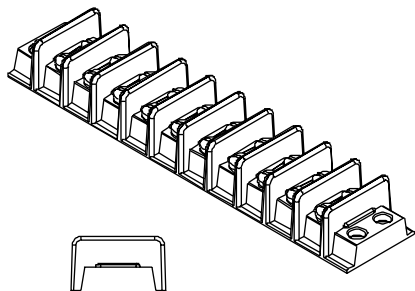

Features and Benefits

- Robust and durable #8-32 screw allows maximum current for use with a 10 AWG wire
- High-temperature Phenolic insulator out performs many thermoplastic compounds

Reference Information

Packaging: Tray
UL File No.: E48521
Flammability: UL 94V-0
Designed In: Inches

Electrical

Voltage: 600V
Current: 30.0A
Dielectric Withstanding Voltage: 2200V AC
Insulation Resistance: 1000 Gigohms min.

Mechanical

Recommended Tightening Torque: 1.80Nm (16 in.-lb)

Physical

Housing: Phenolic
Terminal: Brass
Screw: Steel, #8-32, Phillips/Slot combo head
Plating: Terminal Area—Tin
Screw—Zinc with clear chromate
Wire Range: 10 to 18 AWG
Operating Temperature: -40 to +150°C

Circuits	Order No.	Lead-free
2	38221-0002	Yes
3	38221-0003	
4	38221-0004	
5	38221-0005	
6	38221-0006	

Circuits	Order No.	Lead-free
7	38221-0007	Yes
8	38221-0008	
9	38221-0009	
10	38221-0010	
11	38221-0011	

Circuits	Order No.	Lead-free
12	38221-0012	Yes
13	38221-0013	
14	38221-0014	
15	38221-0015	

Barrier Terminal Strips Accessories

Topside Hardware

- Topside hardware allows circuits to be jumped together or accommodate multiple connections per circuit
- Snap-on cover kits provide a cost-effective method for adding "touch safe" protection in the field
- Loose piece topside hardware enables the flexibility to design the exact part to fit virtually any application

Physical

Topside Hardware—







Material: Brass



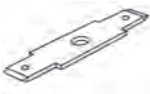

Plating: Tin

Cover Kits—



Material: Cover—Vulcanized Fiber, black

Latches—Acetal, natural

QUICK CONNECTS								Lead-free
Use with Series	Quick Connect Size	Order No.						Lead-free
38700	4.75mm (.187")	38002-1167	38002-1169	38002-1171	38002-1174	38002-1176	38002-1178	Yes
38710	4.75mm (.187")	38002-0023	38002-0025	38002-0028	38002-0019	38002-0022	38002-0039	
	6.35mm (.250")				38002-0299	38002-0302	38002-0406	
38720	4.75mm (.187")	38002-0023	38002-0025	38002-0028	38002-0019	38002-0022	38002-0039	
	6.35mm (.250")				38002-0299	38002-0302	38002-0406	
38730	6.35mm (.250")	38002-1333	38002-1335	38002-1010	38002-1344	38002-1346	38002-1348	
38740	6.35mm (.250")	38002-1333	38002-1335	38002-1010	38002-1344	38002-1346	38002-1348	

JUMPERS					Lead-free
Use with Series	Order No.				Lead-free
38700			38703-65XX*		Yes
38710	38002-0185	38002-0188	Consult Factory		
38720	38002-1226	38002-1228	Consult Factory		
38730	38002-1350	38002-1352		38002-1478	
38740	38002-0331	38002-0333		38002-1478	
				38002-1478	

*XX represents circuit sizes 02, 03, 04, 05, 06, 08, 10, 16.

SOLDER TABS			Lead-free
Use with Series	Order No.		Lead-free
38700	38002-1165		Yes
38710	38002-0017	38002-0020	
38720	38002-0017	38002-0020	
38740	38002-0064	38002-0066	

Snap-On Cover Kits

Use with Series	Order No.	Cover Width	Lead-free
38710	38713-64XX*	16.00mm (.630")	Yes
38720			
38740	38733-64XX*	17.53mm (.690")	

*XX represents circuit sizes 02 to 30.

‡Each kit contains 2 latches and a flat cover.

Commercial Micro-D F-2 to F-7
Industrial RJ-45 (Ethernet) F-8 to F-12
Industrial USB F-13 to F-15

1.27mm (.050") Pitch Commercial Micro-D Plug

83611/83612/83614

Right Angle

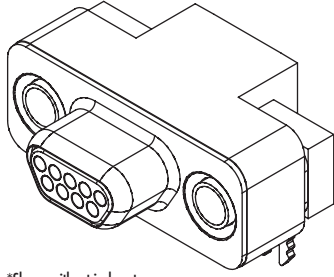

*Shown without jackposts

Features and Benefits

- Economical solution for commercial applications requiring the density of a microminiature connector
- Rugged commercial design with a metal interface and grounding tabs for improved mechanical and electrical shield conditions
- Designed to meet the requirements of SSA applications

Reference Information

UL File No: E34763
 Mates With: 83421, 83422, 83424
 Designed In: Inches
 Packaging: Tube
 PCB Thickness: 1.60mm (.062")
 Lead Free Process Capability: Wave/Surface Mount
 Compatible
 RoHS Compliant

Electrical

Current: 1.0A
 Contact Resistance: 8 milliohms max.

Mechanical

Contact Insertion Force: 3 oz. average
 Unmating Force: 0.5 oz. min.

Physical

Housing: Shell—Nickel-plated 1008LC Steel
 Insulator—LCP, UL 94V-0
 Contact: Pin—Gold-plated Beryllium Copper
 Jackpost: Stainless Steel
 Temperature: -55 to +125°C

Circuits	Order No.		Lead-free
	With Jackposts	Without Jackposts*	
9	83611-9006	83611-9016	Yes
15	83612-9020	83612-9022	
25	83614-9012	83614-9014	

*Jackpost can be ordered separately. Use part number 83041-0005.

1.27mm (.050") Pitch Commercial Micro-D Plug

83611/83612/83614

Vertical

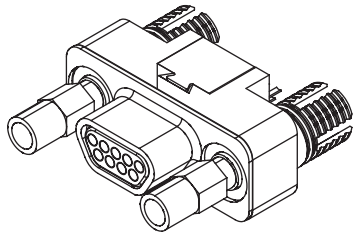

*Shown with optional jackposts

Features and Benefits

- Economical solution for commercial applications requiring the density of a microminiature connector
- Rugged commercial design with a metal interface and grounding tabs for improved mechanical and electrical shield condition
- Designed to meet the requirements of SSA applications

Reference Information

UL File No: E34763
 Mates With: 83421, 83422, 83424
 Designed In: Inches
 Packaging: Tube
 PCB Thickness: 1.60mm (.062")
 Lead Free Process Capability: Wave/Surface Mount
 Compatible
 RoHS Compliant

Electrical

Current: 1.0A
 Contact Resistance: 8 milliohms max.

Mechanical

Contact Insertion Force: 3 oz. average
 Unmating Force: 0.5 oz. min.

Physical

Housing: Shell—Nickel-plated 1008LC Steel
 Insulator—LCP, UL 94V-0
 Contact: Pin—Gold-plated Beryllium Copper
 Jackpost: Stainless Steel
 Temperature: -55 to +125°C

Circuits	Order No.		Lead-free
	With Jackposts	Without Jackposts*	
9	83611-9023	83611-9206	Yes
15	83612-9024	83612-9205	
25	83614-9016	83614-9202	

*Jackpost can be ordered separately. Use part number 83041-0005.

1.27mm (.050") Pitch Commercial Micro-D Plug

83619

Right Angle, Dual Stack

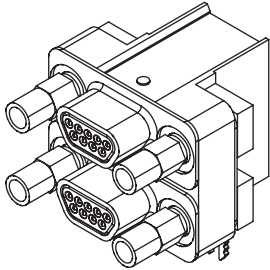

*Shown with optional jackposts.

Features and Benefits

- Economical solution for commercial applications requiring the density of a microminiature connector
- Rugged commercial design with a metal interface and grounding tabs for improved mechanical and electrical shield conditions
- Designed to meet the requirements of SSA applications

Reference Information

UL File No: E34763
 Mates With: 83421, 83422, 83424
 Designed In: Inches
 Packaging: Tube
 PCB Thickness: 1.60mm (.062")
 Lead Free Process Capability: Wave/Surface Mount
 Compatible
 RoHS Compliant

Electrical

Current: 1.0A
 Contact Resistance: 8 milliohms max.

Mechanical

Contact Insertion Force: 3 oz. average
 Unmating Force: 0.5 oz. min.

Physical

Housing: Shell—Nickel-plated 1008LC Steel
 Insulator—LCP, UL 94V-0
 Contact: Pin—Gold-plated Beryllium Copper
 Jackpost: Stainless Steel
 Temperature: -55 to +125°C

Circuits	Order No.		Lead-free
	With Jackposts	Without Jackposts*	
18	83619-9003	83619-9200	Yes
30	83619-9010	83619-9201	
50	83619-9011	83619-9202	

*Jackpost can be ordered separately. Use part number 83041-0005.

1.27mm (.050") Pitch Commercial Micro-D Cable Receptacle

83421/83422/83424

Kit

Features and Benefits

- Economical solution for commercial applications requiring the density of a microminiature connector
- Crimp and poke configuration designed for hand or semiautomatic crimping
- Designed to meet the requirements of SSA applications.

Reference Information

Packaging: Box/Reel
 UL File No: E34763
 Designed In: Inches
 Mates With: 83611, 83612, 83614, 83619
 RoHS Compliant

Electrical

Current: 1.0A
 Contact Resistance: 8 milliohms max.

Mechanical

Contact Insertion Force: 3 oz. average
 Unmating Force: 0.5 oz. min.

Physical

Housing: Shell—Nickel-plated 1008LC Steel
 Insulator—LCP, UL 94V-0
 Contact: Socket—Gold-plated Copper Alloy
 Boot: Santoprene
 Jackscrew: Stainless Steel

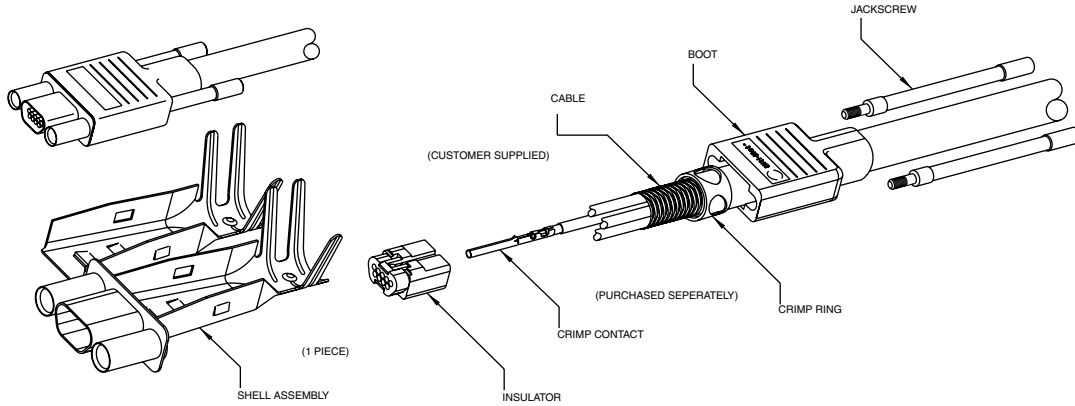

Circuits	Order No.	Lead-free
9	83421-9014	Yes
15	83422-9014	
25	83424-9014	

Socket Terminals

83000*

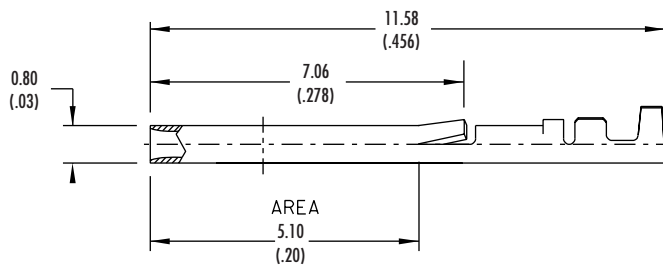

Description	Order No.	Lead-free
2,500 Piece Reel	83000-9502	Yes
50,000 Piece Reel	83000-9503	
Loose	83000-0083	

*Use with 83421/83422/83424

1.27mm (.050") Pitch Commercial Micro-D Cable Receptacle

83421/83422/83424
Assembled

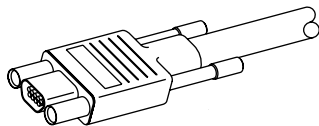

Features and Benefits

- Economical solution for commercial applications requiring the density of a microminiature connector
- Rugged commercial design with a metal interface and grounding tabs for improved mechanical and electrical shield conditions
- Designed to meet the requirements of SSA applications

Reference Information

UL File No: E34763
Mates With: 83611, 83612, 83614, 83619
RoHS Compliant

Electrical

Current: 1.0A
Contact Resistance: 8 milliohms max.

Mechanical

Contact Insertion Force: 3 oz. average
Unmating Force: 0.5 oz. min.

Physical

Housing: Shell—Nickel-plated 1008LC Steel
Insulator—LCP, UL 94V-0
Contact: Pin—Gold-plated Beryllium Copper
Boot: Santoprene
Jackpost: Stainless Steel
Cable: 28 AWG, PVC Jacket—Shielded -85°C, 300V UL 2464
Temperature: -55 to +125°C

Circuits	Order No.			Lead-free
	Length			
	0.46m (1.50')	0.91m (3.0')	1.83m (6.0')	
9	83421-9042	83421-9043	83421-9044	Yes
15	83422-9007	83422-9013	83422-9018	
25	83424-9019	83424-9020	83424-9021	

1.27mm (.050") Pitch Commercial Micro-D Cable Assembly

83421/83422/83424
Commercial Micro-D
to Commercial Micro-D

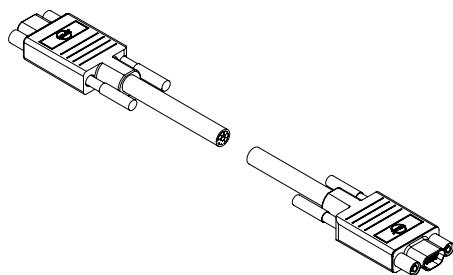

Features and Benefits

- Economical solution for commercial applications requiring the density of a microminiature connector
- Rugged commercial design with a metal interface and grounding tabs for improved mechanical and electrical shield conditions

Reference Information

Packaging: Bag
UL File No.: E34763
Mates With: 83611, 83612, 83614 and 83619
Designed In: Inches

Electrical

Current: 1.0A
Contact Resistance: 8 milliohms

Mechanical

Contact Insertion Force: 3 oz average
Unmating Force: 0.5 oz min.

Physical

Housing: Shell—Steel
Insulator—LCP, UL 94V-0
Contact: Pin—Beryllium Copper
Plating: Shell—Nickel
Contact Area—Gold
Cable: 28 AWG, PVC Jacket—Shielded 85°, 300V UL 2464
Jackposts: Stainless Steel
Operating Temperature: -55 to +125°C

Circuits	Order No.			Lead-free
	Length			
	0.46m (1.50')	0.91m (3.00')	1.83m (6.00')	
9	83421-9049	83421-9050	83421-9051	Yes
15	83422-9053	83422-9054	83422-9055	
25	83424-9057	83424-9058	83424-9059	

1.27mm (.050") Pitch Commercial Micro-D Cable Assembly

83421/83422/83424

Commercial Micro-D to
D-Subminiature Socket

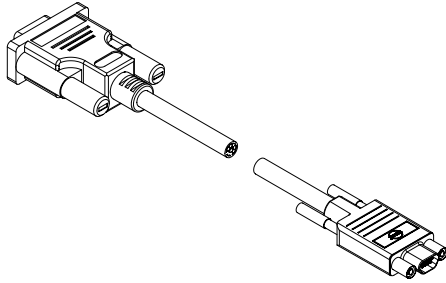

Features and Benefits

- Economical solution for commercial applications requiring the density of a microminiature connector
- Rugged commercial design with a metal interface and grounding tabs for improved mechanical and electrical shield conditions

Reference Information

Packaging: Bag
UL File No.: E34763
Mates With: 83611, 83612, 83614 and 83619
Designed In: Inches

Electrical

Current: 1.0A
Contact Resistance: 8 milliohms

Mechanical

Contact Insertion Force: 3 oz average
Unmating Force: 0.5 oz min.

Physical

Housing: Shell—Steel
Insulator—LCP, UL 94V-0
Contact: Socket—Beryllium Copper
Plating: Shell—Nickel
Contact Area—Gold
Cable: 28 AWG, PVC Jacket—Shielded 85°, 300V UL 2464
Jackposts: Stainless Steel
Operating Temperature: -55 to +125°C

Circuits	Order No.			Lead-free
	Length			
	0.46m (1.50')	0.91m (3.00')	1.83m (6.00')	
9	83421-9039	83421-9040	83421-9041	Yes
15	83422-9056	83422-9057	83422-9058	
25	83424-9063	83424-9064	83424-9065	

1.27mm (.050") Pitch Commercial Micro-D Cable Assembly

83421/83422/83424

Commercial Micro-D to
D-Subminiature Pin

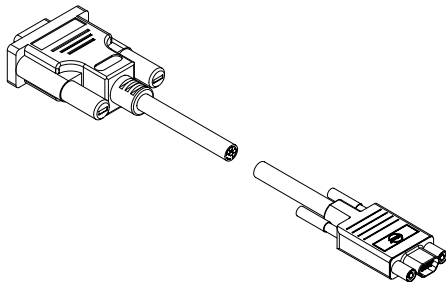

Features and Benefits

- Economical solution for commercial applications requiring the density of a microminiature connector
- Rugged commercial design with a metal interface and grounding tabs for improved mechanical and electrical shield conditions

Reference Information

Packaging: Bag
UL File No.: E34763
Mates With: 83611, 83612, 83614 and 83619
Designed In: Inches

Electrical

Current: 1.0A
Contact Resistance: 8 milliohms

Mechanical

Contact Insertion Force: 3 oz average
Unmating Force: 0.5 oz min.

Physical

Housing: Shell—Steel
Insulator—LCP, UL 94V-0
Contact: Socket—Beryllium Copper
Plating: Shell—Nickel
Contact Area—Gold
Cable: 28 AWG, PVC Jacket—Shielded 85°, 300V UL 2464
Jackposts: Stainless Steel
Operating Temperature: -55 to +125°C

Circuits	Order No.			Lead-free
	Length			
	0.46m (1.50')	0.91m (3.00')	1.83m (6.00')	
9	83421-9039	83421-9037	83421-9038	Yes
15	83422-9059	83422-9060	83422-9061	
25	83424-9060	83424-9061	83424-9062	

1.27mm (.050") Pitch Commercial Micro-D Panel Mount Header

83411/83414

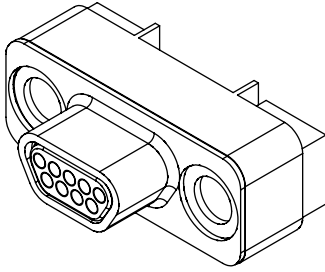

Features and Benefits

- Economical solution for commercial applications requiring the density of a microminiature connector
- Crimp and poke configuration designed for hand or semi automatic crimping

Reference Information

Packaging: Tube
UL File No.: E34763
Mates With: 83421, 83422 and 83424
Designed In: Inches

Electrical

Current: 1.0A
Contact Resistance: 8 milliohms

Mechanical

Contact Insertion Force: 3 oz average
Unmating Force: 0.50 oz min.

Physical

Housing: Shell—Steel
Insulator—LCP, UL 94V-0
Contact: Socket—Copper Alloy
Plating: Shell—Nickel
Contact—Gold
Operating Temperature: -55 to +125°C

Circuits	Order No.	Lead-free
9	83411-9110	Yes
15	Contact Molex	
25	83414-9021	

Jackposts need to be ordered separately. Use order number: 83041-0005

Pin Terminals

83000



Description	Order No.	
	15µ Gold	50µ Gold
2,500 Piece Reel	83000-9561	83000-9558
50,000 Piece Reel	83000-9562	83000-9559
Loose	83000-9560	83000-0110

Ethernet Sealed RJ-45 Overmolded Cordsets

84702

Single Ended Bayonet Style RJ-45 Plug

Industrial I/O

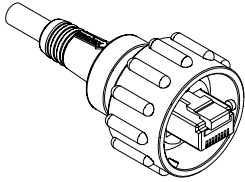

F

Features and Benefits

- One sealing surface reduces chance of failure
- IP67 and NEMA 6P ratings ensure cable assemblies for water and dust tight functional integrity
- Bayonet style latching provides audible and tactile confirmation of positive mating
- Category 5e specified provides high data transmission speeds
- Overmolded cable assemblies allow for faster installation

Reference Information

Packaging: Bag
 Mates With: 84700 and 84702
 Designed In: Inches

Electrical

Voltage: 150V AC
 Current: 1.5A
 Contact Resistance: 20 milliohms max.
 Dielectric Withstanding Voltage:
 Adjacent Contacts—1000V AC
 Contacts to Ground—1500V AC
 Insulation Resistance: 500 Megohms min.
 Type: Category 5e
 Transmission Performance: Category 5e
 RJ-45 Connection Interface: TIA/EIA-568-B
 Shielding Effectiveness: 20 dB min.

Mechanical

Durability: 200 mating cycles min.
 Coupling Ring Destructive Torque: 2.26Nm (20 in. lb) or more

Physical

Overmolded Body: PVC, black
 Coupling Ring: PBT, black
 Holder: PBT, black
 Wedge: PBT, black
 Gasket Seal: Nitrile, black
 Contact: Phosphor Bronze
 Plating: Contact Area—1.27µm (50µ") Gold
 Underplating—Nickel
 Operating Temperature: -40 to +85°C

Length	Order No.	Lead-free
0.30m (1.00')	84702-3001	Yes
0.91m (3.00')	84702-3003	
1.83m (6.00')	84702-3006	
2.74m (9.000')	84702-3009	
3.66m (12.00')	84702-3012	
6.10m (20.00')	84702-3020	
15.20m (50.00')	84702-3050	
30.50m (100.00')	84702-3100	

Ethernet Sealed RJ-45 Overmolded Cordsets

84702

Double Ended Bayonet Style RJ-45 Plug-to-Bayonet Style RJ-45 Plug

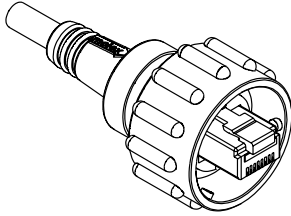

Features and Benefits

- One sealing surface reduces chance of failure
- IP67 and NEMA 6P ratings ensure cable assemblies are water and dust tight for functional integrity
- Bayonet style latching provides audible and tactile confirmation of positive mating
- Category 5e specified provides high data transmission speeds
- Overmolded cable assemblies allow for faster installation

Reference Information

Packaging: Bag
Mates With: 84700 and 84702
Designed In: Inches

Electrical

Voltage: 150V AC
Current: 1.5A
Contact Resistance: 20 milliohms max.
Dielectric Withstanding Voltage:
Adjacent Contacts—1000V AC
Contacts to Ground—1500V AC
Insulation Resistance: 500 Megohms min.
Transmission Performance: Category 5e
RJ-45 Connection Interface: TIA/EIA-568-B
Shielding Effectiveness: 20 dB min.

Mechanical

Durability: 200 mating cycles min.
Coupling Ring Destructive Torque: 2.26Nm (20 in. lb) or more

Physical

Overmolded Body: PVC, black
Coupling Ring: PBT, black
Holder: PBT, black
Wedge: PBT, black
Gasket Seal: Nitrile, black
Contact: Phosphor Bronze
Plating: Contact Area—1.27µm (50µ") Gold
Underplating—Nickel
Operating Temperature: -40 to +85°C

Length	Order No.	Lead-free
0.30m (1.00')	84702-1001	Yes
0.91m (3.00')	84702-1003	
1.83m (6.00')	84702-1006	
2.13m (7.00')	84702-1007	
2.74m (9.000')	84702-1009	
3.00m (10.00')	84702-1010	
3.66m (12.00')	84702-1012	
4.57m (15.00')	84702-1015	
6.10m (20.00')	84702-1020	
6.40m (21.00')	84702-1021	
9.14m (30.00')	84702-1030	

Ethernet Sealed RJ-45 Overmolded Cordsets

84702

Double Ended Bayonet Style RJ-45 Plug-to-Standard RJ-45 Plug

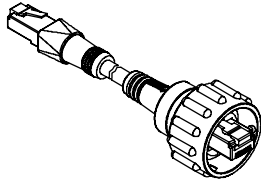

Features and Benefits

- One sealing surface reduces chance of failure
- IP67 and NEMA 6P ratings ensure cable assemblies are water and dust tight for functional integrity
- Bayonet style latching provides audible and tactile confirmation of positive mating
- Category 5e specified provides high data transmission speeds
- Overmolded cable assemblies allow for faster installation

Reference Information

Packaging: Bag
Mates With: 84700 and 84702
Designed In: Inches

Electrical

Voltage: 150V AC
Current: 1.5A
Contact Resistance: 20 milliohms max.
Dielectric Withstanding Voltage:
Adjacent Contacts—1000V AC
Contacts to Ground—1500V AC
Insulation Resistance: 500 Megohms min.
Transmission Performance: Category 5e
RJ-45 Connection Interface: TIA/EIA-568-B
Shielding Effectiveness: 20 dB min.

Mechanical

Durability: 200 mating cycles min.
Coupling Ring Destructive Torque: 2.26Nm (20 in. lb) or more

Physical

Overmolded Body: PVC, black
Coupling Ring: PBT, black
Holder: PBT, black
Wedge: PBT, black
Gasket Seal: Nitrile, black
Contact: Phosphor Bronze
Plating: Contact Area—1.27 μ m (50 μ ”) Gold
Underplating—Nickel
Operating Temperature: -40 to +85°C

Length	Order No.	Lead-free
0.30m (1.00')	84702-2001	Yes
0.91m (3.00')	84702-2003	
1.83m (6.00')	84702-2006	
2.13m (7.00')	84702-2007	
2.74m (9.000')	84702-2009	
3.00m (10.00')	84702-2010	
3.66m (12.00')	84702-2012	
4.57m (15.00')	84702-2015	
6.10m (20.00')	84702-2020	
6.40m (21.00')	84702-2021	
9.14m (30.00')	84702-2030	

RJ-45 Field Wireable Ethernet Connectors

84700

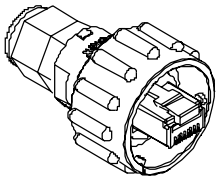

Features and Benefits

- One sealing surface reduces chance of failure
- IP67 and NEMA 6P ratings ensure cable assemblies are water and dust tight for functional integrity
- Bayonet style latching provides audible and tactile confirmation of positive mating
- Superior strain relief
- Easy termination allows custom length cable to be made in the field
- Compatible with shielded and unshielded cable
- Meets ODVA/EtherNet™ IP* specification

Reference Information

Packaging: Bag
Mates With: 84700 and 84702
Designed In: Inches
Waterproof: Meets requirements of IP67 and NEMA 6P for water tightness

Electrical

Voltage: 56.5V DC
150V RMS AC (ringing voltage only)
Current: 1.5A at 25°C (77°F)
Contact Resistance: 20 milliohms max.
Insulation Resistance: 500 Megohms min.
Transmission Performance: Category 5e
RJ-45 Connection Interface: TIA/EIA-568-B
Shielding Effectiveness: 20 dB min.

Mechanical

Durability: 500 mating cycles min.

Physical

Coupling Ring: PBT, black
O-Ring: Nitrile
Gasket Seal: Nitrile, black
Plug Holder: PBT, black
Retainer Wedge: PBT, black
Wire Gauge: 24 AWG (stranded or solid conductors)
Operating Temperature: -40 to +85°C
Cable Seal Assembly: Polyamide, TPE Gland, black

Description	Order No.	Lead-free
Field Attachable Plug	84700-0002	Yes

*EtherNet IP is a trademark of the Open DeviceNet Vendor Association.

Bayonet Style Tethered Dust Cap

84700

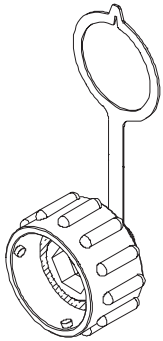

Features and Benefits

- One sealing surface means less likelihood of failure
- Attachable tether so cap never gets lost
- Maintains IP67 and NEMA 6P ratings for functional integrity when connector is not mated
- IP67 and NEMA 6P ratings ensure cable assemblies are water and dust tight for functional integrity

Reference Information

Packaging: Bag
Use With: 84700, 84702, 84729, 84730
Designed In: Inches

Physical

Dust Cap: PBT, black
Tether: PE or PP, black
Gasket Seal: Nitrile, black
Screw: Brass, #8-32
Plating: Screw—Nickel
Operating Temperature: -40 to +85°C

Description	Order No.	Lead-free
Dust Cover	84700-0003	Yes

Ethernet Sealed RJ-45 Receptacles

84702

PCB Mount and
Punchdown Panel Mount

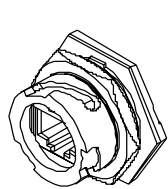

PCB Mount

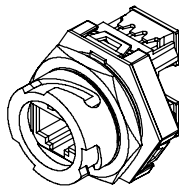

Punchdown Panel Mount

Features and Benefits

- One sealing surface reduces chance of failure
- Bayonet style latching provides audible and tactile confirmation of positive mating
- Punchdown version supports simple IDC termination

Reference Information

Packaging: Bag
Mates With: 84700 and 84702
Designed In: Inches

Electrical

Voltage: 150V AC
Current: 1.5A
Contact Resistance: 20 milliohms max.
Dielectric Withstanding Voltage:
Adjacent Contacts—1000V AC
Contacts to Ground—1500V AC
Insulation Resistance: 500 Megohms min.
Transmission Performance: Category 5e
RJ-45 Connection Interface: TIA/EIA-568-B
Shielding Effectiveness: 20 dB min.

Mechanical

Durability: 200 mating cycles min.
Lock Nut Destructive Torque: 2.71Nm (24 in. lb)

Physical

Receptacle Housing: PBT, black
Lock Nut: Polyamide 6/6, black
Panel Gasket: Neoprene, black
Punchdown Block: Thermoplastic, white
Wire Range (Punchdown Receptacle):
22 to 26 AWG solid and stranded, limiting outside diameter 1.40mm (.055")
Operating Temperature: -40 to +85°C

Description	Order No.	Lead-free
PCB Mount Receptacle	84702-0005	Yes
Punchdown Panel Mount Receptacle	84702-0006	

Ethernet Sealed RJ-45 Panel Mount Bulkhead Passthrough Receptacle

84700

Industrial I/O

F

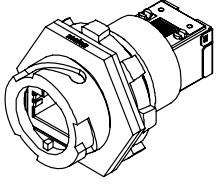

Features and Benefits

- Back-to-back RJ-45 passthrough brings ethernet connectivity into a control cabinet and eliminates need for conduit entry
- Bayonet style latching provides audible and tactile confirmation of positive mating
- Meets ODVA/EtherNet™ IP specification

Reference Information

Packaging: Bag
Designed in: Inches
Mates With: 84700 and 84702
Waterproof: Meets requirements of IP67 and NEMA 6P for water tightness

Electrical

Voltage: 150V AC
Current: 1.5A
Contact Resistance: 20 milliohms max.
Insulation Resistance: 500 Megohms min.
Transmission Performance: Category 5e
RJ-45 Connection Interface: TIA/EIA-568-B
Shielding Effectiveness: 20 dB min.
Return Loss: 5 dB at 100MHz

Mechanical

Durability: 500 mating cycles min.

Physical

Receptacle Housing: PBT, black
Panel Gasket: Neoprene, black
Lock Nut: Steel
Plating: Lock Nut—Zinc
Operating Temperature: -40 to +85°C

Description	Order No.	Lead-free
Panel Mount Receptacle	84700-0001	Yes

*EtherNet IP and DeviceNet are trademarks of the Open DeviceNet Vendor Association.

Industrial USB Shielded Overmolded Cordset

84732

Double Ended Bayonet Style Type-A Plug to Bayonet Style Type-B Plug

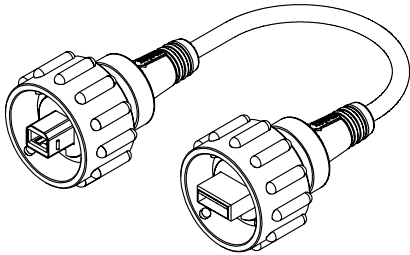

Length	Order No.	Lead-free
0.80m (2.62')	84732-0001	Yes
1.50m (4.92')	84732-0002	
2.0m (6.56')	84732-0003	
3.0m (9.84')	84732-0004	
5.0m (16.40')	84732-0005	

Features and Benefits

- Standard USB shielded I/O system in a rugged, industrial sealed package
- Fully shielded for EMI/RFI protection
- IP67 and NEMA 6P rated cable assemblies are water and dust tight for functional integrity
- Bayonet style latching provides audible and tactile confirmation of positive mating

Reference Information

Packaging: Bag
Mates With: 84729 and 84730
Designed In: Inches
Flammability: UL 94V-0
Performance: USB 2.0

Electrical

Voltage: 30V
Current: 1.0A
Contact Resistance: 30 milliohms max.
Dielectric Withstanding Voltage: 750V AC
Insulation Resistance: 1000 Megohms min.

Mechanical

Mating Force: 35N (7.87 lb) max.
Withdrawal Force: 10N (2.25 lb) min.
Durability: 1000 mating cycles

Physical

Overmolding: PVC, black
Coupling Ring: Polyester, black
Contact: Copper Alloy
Plating: Contact Area—0.75 μ m (30 μ in) Gold
Underplating—Nickel
Gasket Seal: Nitrile, black
Operating Temperature: 0 to +70°C

Industrial USB Shielded Overmolded Cordset

84727

Bayonet Style Type-A Plug to Shielded Pigtail

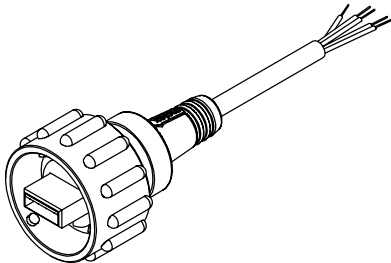

Length	Order No.	Lead-free
0.15m (.49')	84727-1005	Yes
1.50m (4.92')	84727-1002	
2.0m (6.56')	84727-1001	
3.0m (9.84')	84727-1003	
5.0m (16.40')	84727-1004	

Features and Benefits

- Standard USB shielded I/O system in a rugged, industrial sealed package
- Fully shielded for EMI/RFI protection
- IP67 and NEMA 6P rated cable assemblies are water and dust tight for functional integrity
- Bayonet style latching provides audible and tactile confirmation of positive mating
- Compliance with USB 2.0 specification

Reference Information

Packaging: Bag
Mates With: 84729
Designed In: Inches
Flammability: UL 94V-0
Performance: USB 2.0

Electrical

Voltage: 30V
Current: 1.0A
Contact Resistance: 30 milliohms max.
Dielectric Withstanding Voltage: 750V AC
Insulation Resistance: 1000 Megohms min.

Mechanical

Mating Force: 35N (7.87 lb) max.
Withdrawal Force: 10N (2.25 lb) min.
Durability: 1000 mating cycles

Physical

Overmolding: PVC, black
Coupling Ring: Polyester, black
Contact: Copper Alloy
Plating: Contact Area—0.75 μ m (30 μ in) Gold
Underplating—Nickel
Gasket Seal: Nitrile, black
Operating Temperature: 0 to +70°C

Industrial USB Shielded Overmolded Cordset

84728

Bayonet Style Type-B Plug to Shielded Pigtail

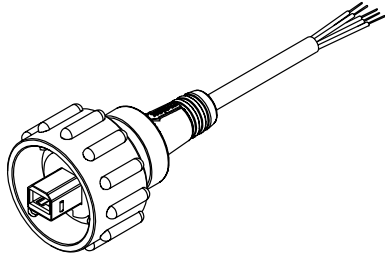

Length	Order No.	Lead-free
0.15m (.49')	84728-1005	Yes
1.50m (4.92')	84728-1002	
2.0m (6.56')	84728-1001	
3.0m (9.84')	84728-1003	
5.0m (16.40')	84728-1004	

Features and Benefits

- Standard USB shielded I/O system in a rugged, industrial sealed package
- Fully shielded for EMI/RFI protection
- IP67 and NEMA 6P rated cable assemblies are water and dust tight for functional integrity
- Bayonet style latching provides audible and tactile confirmation of positive mating
- Compliance with USB 2.0 specification

Reference Information

Packaging: Bag
 Mates with: 84730
 Designed In: Inches
 Flammability: UL 94V-0
 Performance: USB 2.0

Electrical

Voltage: 30V
 Current: 1.0A
 Contact Resistance: 30 milliohms max.
 Dielectric Withstanding Voltage: 750V AC
 Insulation Resistance: 1000 Megohms min.

Mechanical

Mating Force: 35N (7.87 lb) max.
 Withdrawal Force: 10N (2.25 lb) min.
 Durability: 1000 mating cycles

Physical

Overmolding: PVC, black
 Coupling Ring: Polyester, black
 Contact: Copper Alloy
 Plating: Contact Area—0.75 μ m (30 μ l") Gold
 Underplating—Nickel
 Gasket Seal: Nitrile, black
 Operating Temperature: 0 to +70°C

Industrial USB Shielded Overmolded Cordset

84729

Type-A Sealed Panel Mount Receptacle to Standard Type-A Plug

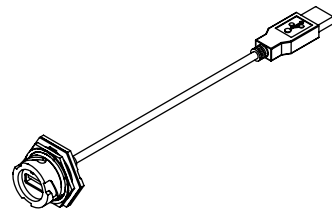

Length	Order No.	Lead-free
0.152m (.498')	84729-0003	Yes
0.8m (2.62')	84729-0004	
1.50m (4.92')	84729-0005	
2.0m (6.56')	84729-0006	
3.0m (9.84')	84729-0007	
5.0m (16.40')	84729-0008	

Features and Benefits

- Standard USB shielded I/O system in a rugged, industrial sealed package
- Fully shielded for EMI/RFI protection
- IP67 and NEMA 6P rated cable assemblies are water and dust tight for functional integrity
- Bayonet style latching provides audible and tactile confirmation of positive mating
- Compliance with USB 2.0 specification

Reference Information

Packaging: Bag
 Mates With: 84727 and 84732
 Designed In: Inches
 Flammability: UL 94V-0
 Performance: USB 2.0

Electrical

Voltage: 30V
 Current: 1.0A
 Contact Resistance: 30 milliohms max.
 Dielectric Withstanding Voltage: 750V AC
 Insulation Resistance: 1000 Megohms min.

Mechanical

Lock Nut Destructive Torque: 2.71Nm (24 in. lb) or more
 Mating Force: 35N (7.87 lb) max.
 Withdrawal Force: 10N (2.25 lb) min.
 Durability: 1000 mating cycles

Physical

Overmolding: PVC, black
 Receptacle Housing: PBT, black
 Lock Nut: PBT, black
 Contact: Copper Alloy
 Plating: Contact Area—0.75 μ m (30 μ l") Gold
 Underplating—Nickel
 Panel Gasket: Neoprene, black
 Operating Temperature: 0 to +70°C

Industrial USB Panel Mount PCB Receptacle

84729/84730

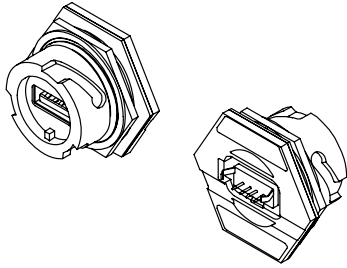

Features and Benefits

- Standard USB shielded I/O system in a rugged, industrial sealed package
- Fully shielded for EMI/RFI protection
- IP67 and NEMA 6P rated cable assemblies are water and dust tight for functional integrity
- Bayonet style latching provides audible and tactile confirmation of positive mating
- Compliance with USB 2.0 specification ensures compatibility with standard USB cables

Reference Information

Packaging: Bag
 Mates With: Type A—84727 and 84732
 Type B—84728 and 84732
 Designed In: Inches
 Flammability: UL 94V-0
 Performance: USB 2.0

Electrical

Voltage: 30V
 Current: 1.0A
 Contact Resistance: 30 milliohms max.
 Dielectric Withstanding Voltage: 750V AC
 Insulation Resistance: 1000 Megohms min.

Mechanical

Lock Nut Destructive Torque: 2.71Nm (24 in. lb) or more
 Mating Force: 35N (7.87 lb) max.
 Withdrawal Force: 10N (2.25 lb) min.
 Durability: 1000 mating cycles

Physical

Receptacle Housing: PBT, black
 Lock Nut: Polyamide 6/6, black
 Contact: Copper Alloy
 Plating: Contact Area—0.75µm (30µ") Gold
 Underplating—Nickel
 Gasket Seal: Neoprene, black
 Operating Temperature: 0 to +70°C

Description	Order No.	Lead-free
USB Type A	84729-0009	Yes
USB Type B	84730-0001	

Industrial USB Type-A Panel Mount Receptacle

84729

Bayonet Style to
5-Circuit Pigtail

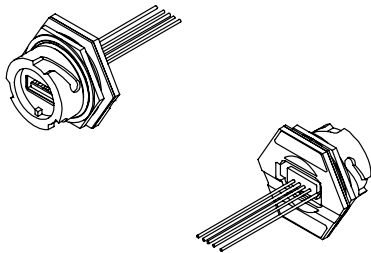

Features and Benefits

- Standard USB shielded I/O system in a rugged, industrial sealed package
- Fully shielded for EMI/RFI protection
- IP67 and NEMA 6P rated cable assemblies are water and dust tight for functional integrity
- Bayonet style latching provides audible and tactile confirmation of positive mating
- Compliance with USB 2.0 specification

Reference Information

Packaging: Bag
 Mates With: 84727 and 84732
 Designed In: Inches
 Flammability: UL 94V-0
 Performance: USB 2.0

Electrical

Voltage: 30V
 Current: 1.0A
 Contact Resistance: 30 milliohms max.
 Dielectric Withstanding Voltage: 750V AC
 Insulation Resistance: 1000 Megohms min.

Mechanical

Lock Nut Destructive Torque: 2.71Nm (24 in. lb) or more
 Mating Force: 35N (7.87 lb) max.
 Withdrawal Force: 10N (2.25 lb) min.
 Durability: 1000 mating cycles

Physical

Receptacle Housing: PBT, black
 Lock Nut: Polyamide 6/6, black
 Contact: Copper Alloy
 Plating: Contact Area—0.75µm (30µ") Gold
 Underplating—Nickel
 Gasket Seal: Neoprene, black
 Wire Gauge: 28 AWG
 Operating Temperature: 0 to +70°C

Length	Order No.	Lead-free
0.15m (.49")	84729-0001	Yes

14 to 22 AWG, 5.84mm (.230") PitchG-4 to G-13
8 to 12 AWG, 7.62mm (.300") PitchG-14 to G-18

MX150L™ Sealed Connector System

The pre-assembled, submersible MX150L is a high performance connector system suitable for challenging, rugged and harsh applications.

The MX150L sealed connector system is designed to meet the need for a rugged, environmentally sealed connector system supporting both low-level signal applications as well as power applications up to 40.0A, from on-engine automotive and marine applications to off-road construction equipment applications. The system is comprised of wire-to-wire, wire-to-panel and wire-to-board configurations.

These innovative mat-sealed connectors are based upon the 1.50 and 2.50mm (.059 and .098") blade-type terminals. This design eliminates the need to purchase, handle and crimp individual wire seals to lower applied cost. The mat-seal design is a single silicone-based seal with individual wire openings and a seal cap to protect, securely retain and provide strain relief to the seal. The cost-effective connector design features all-in-one plug and receptacle housings with pre-assembled mat-wire and interfacial connector seals. Integral Terminal Position Assurance (TPA) and optional Connector Position Assurance (CPA) components eliminate time-consuming and costly assembly operations. Completing the application is as simple as crimping the appropriate terminal, inserting the crimped terminal lead and seating the TPA to its final locked position. No additional components are required.

Tooling solutions include FineAdjust™ crimp press applicators for high-volume production, as well as hand tools for low-volume production and field repairs.

MX150L™

G

Features and Benefits

- Pre-assembled connector housings, seals, TPA components and mat-seal cap shipped in 1 piece to provide applied labor and cost savings
- Integral TPA assures that crimped terminal leads are properly locked into connector (TPA will not seat into final lock position and connector system will not latch if terminal is not locked properly into position)
- Conforms to UL 1977, which allows for a UL recognized sealed connector system for use in data, signal, control and power applications
- Superior electrical and mechanical performance capabilities surpass performance of most mature competitive products in market
- Audible and tactile clicks on insertion, extraction and mating feedback facilitates reliable mating and terminal loading and removal
- Unused circuits can be blocked using plastic seal plugs, which facilitates flexibility of sealing unused circuits without adding complexity to part numbers and customer inventory
- Integral locking latch with secondary, pre-loaded CPA option assures that connector system is properly latched. CPA will not move to final locked position if connector is not latched. Confirms positive mating of connector
- Integral, 2-way mat and interface seals designed and tested to IEC IP 67 exceeds "waterproof" demands as a true sealed connector system tested under submersed conditions in various fluids
- Easy terminal insertion and extraction provides quick, low-cost field repairs using common screwdriver, needle nose pliers and terminal extraction tool
- Protective mat-seal cap protects, securely retains and provides strain relief to wire seal interface
- Simple crimp, poke and plug application eliminates need to crimp individual wire seals

MX150L Sealed Connector Systems - Exploded View

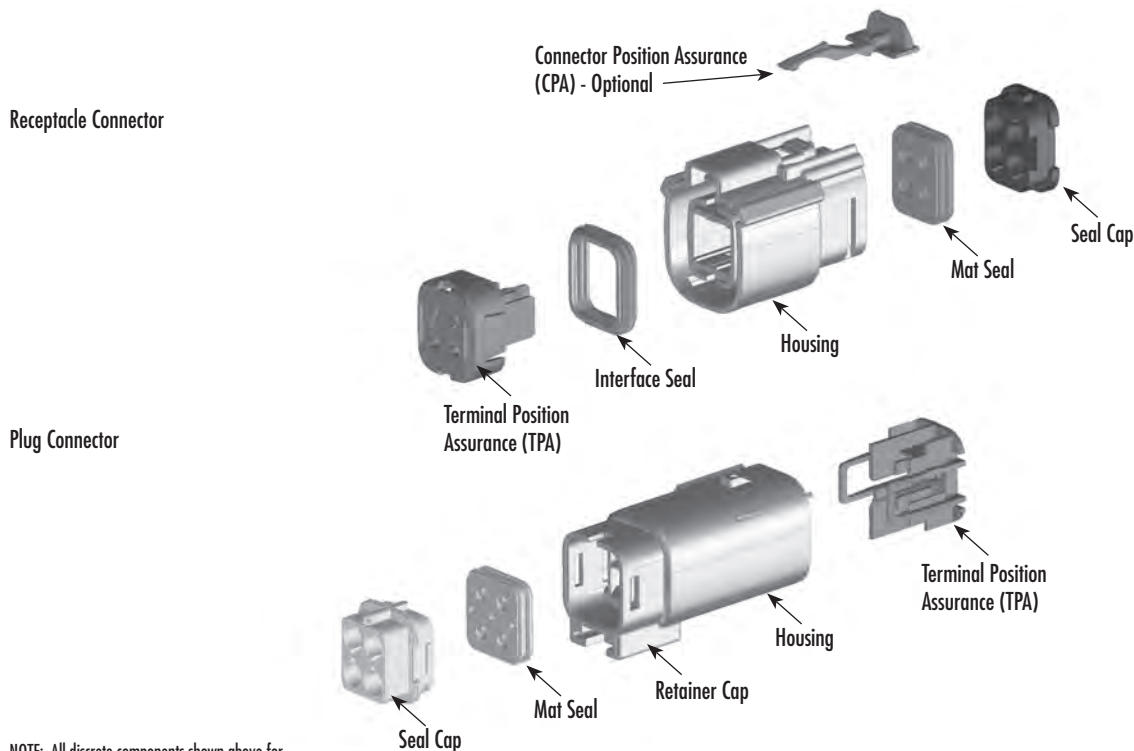

NOTE: All discrete components shown above for both the receptacle and plug housings are pre-assembled. Terminals are simply crimped and poked into the housings. No additional wire seals, wedge locks or CPA locks are required.

MX150L™ Product Overview

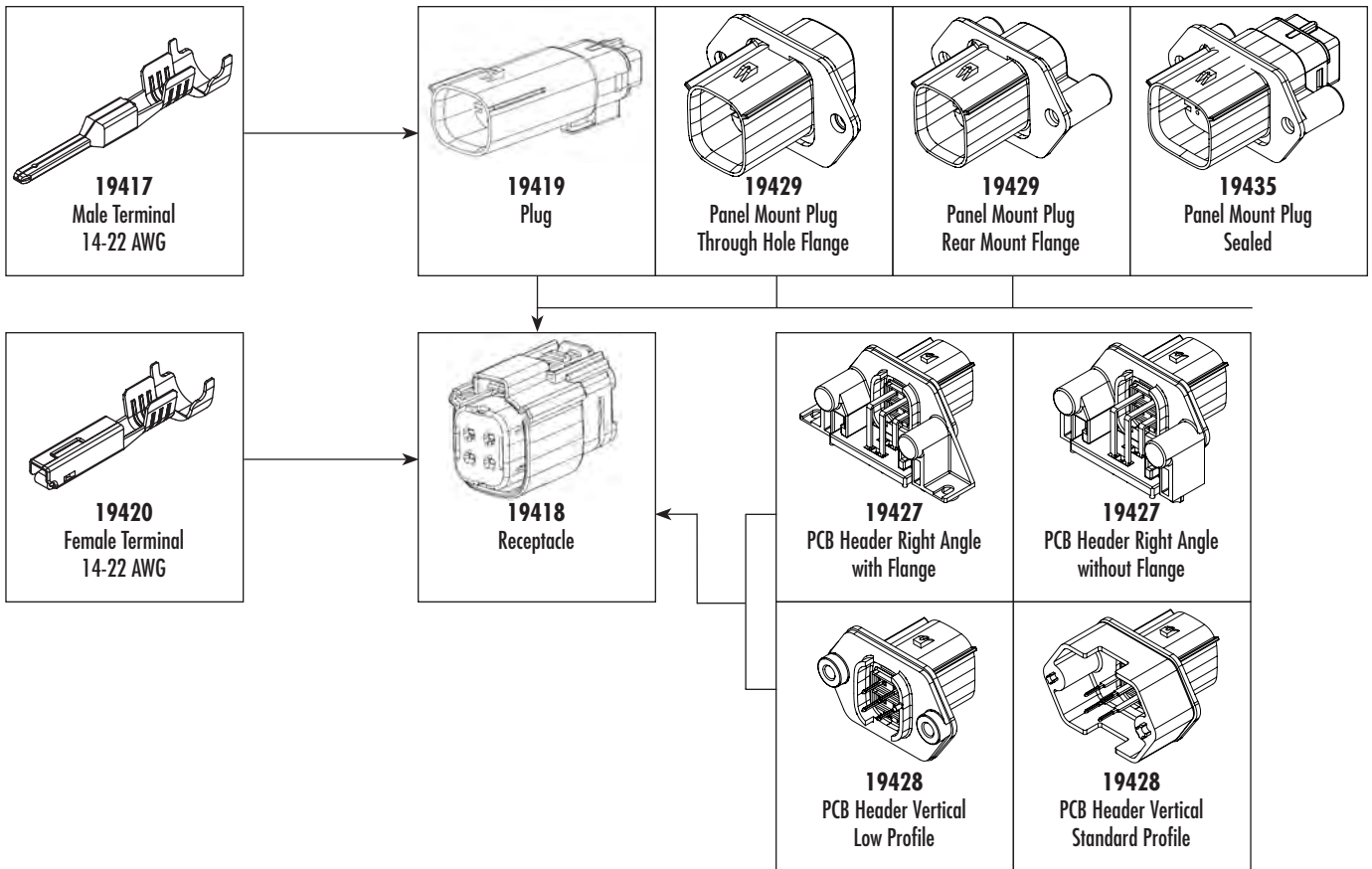

MX150L™

G

8, 10 and 12 AWG Wire-to-Wire

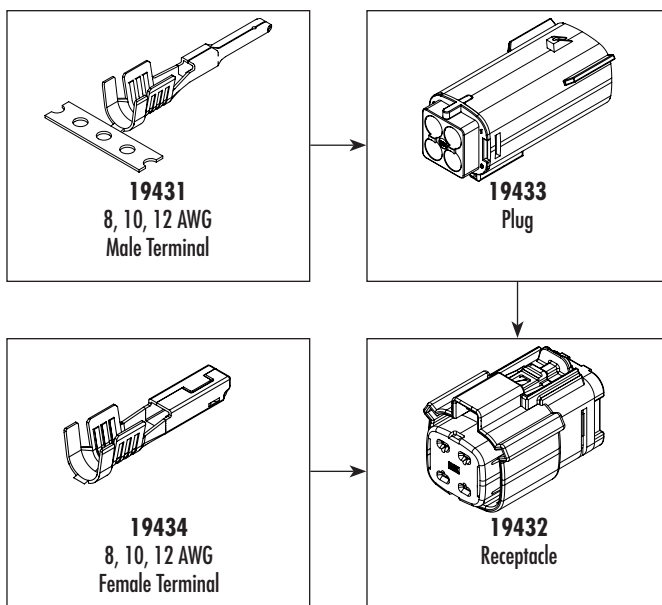

5.84mm (.230") Pitch MX150L™ Terminal

19420
Female

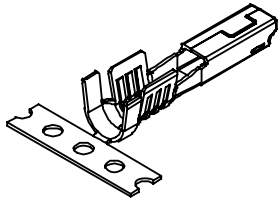

Features and Benefits

- Mat-seal friendly design features center seam and coined edges
- Anti-over stress beam geometry feature
- Low insertion force

Reference Information

Packaging: Bag, reel
UL File No.: E152602
Use With: 19418
Designed In: Inches

Electrical

Current: 18.0A

Mechanical

Contact Insertion Force: 1 lb max.
Durability: Tin Plating—25 cycles
Gold Plating—100 cycles

Physical

Contact: Copper Alloy
Plating: Tin or Gold

MX150L™

G

Wire Range AWG	Insulation Diameter mm (in)	Order No.				Lead-free
		Pre-Tin		Gold		
		Strip	Loose	Strip	Loose	
18-22	2.36-2.74 (.093 - .108)	19420-0002	19420-0010	19420-0004	19420-0012	Yes
14-16	2.87-3.53 (.113 - .139)	19420-0001	19420-0009	19420-0003	19420-0011	

5.84mm (.230") Pitch MX150L™ Terminal

19417
Male

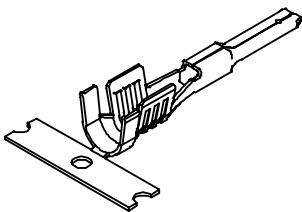

Features and Benefits

- Mat-seal friendly design features center seam and coined edges
- Low insertion force

Reference Information

Packaging: Bag, reel
UL File No.: E152602
Use With: 19419, 19429 and 19435
Designed In: Inches

Electrical

Current: 18.0A

Mechanical

Contact Insertion Force: 1 lb max.
Durability: Tin Plating—25 cycles
Gold Plating—100 cycles

Physical

Contact: Copper Alloy
Plating: Tin or Gold

Wire Range AWG	Insulation Diameter mm (in)	Order No.				Pin Length	Lead-free
		Pre-Tin		Gold			
		Strip	Loose	Strip	Loose		
18-22	2.36-2.74 (.093 - .108)	19417-0024	19417-0048	19417-0026	19417-0050	Standard	Yes
14-16	2.87-3.53 (.113 - .139)	19417-0011	19417-0047	19417-0025	19417-0049		
18-22	2.36-2.74 (.093 - .108)	19417-0028	19417-0052	19417-0030	19417-0054	Long	
14-16	2.87-3.53 (.113 - .139)	19417-0027	19417-0051	19417-0029	19417-0053		

5.84mm (.230") Pitch MX150L™ Receptacle

19418
Single Row

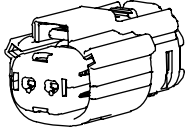

Features and Benefits

- Environmentally sealed to IP67
- Integrated interface seal and Terminal Position Assurance (TPA)
- Optional Connector Position Assurance (CPA)
- Simple crimp and poke application
- Field serviceable contact removal system
- Tactile and audible mating feedback

Reference Information

Packaging: Tray
 UL File No.: E152602
 Mates With: 19419, 19427, 19428,
 19429 and 19435
 Use With: 19420
 Designed In: Inches

Electrical

Voltage: 600V
 Dielectric Withstanding Voltage: 2200V AC min.
 Insulation Resistance: 1000 Megohms

Mechanical

Mating Force: 75N max.
 Unmating Force: 75N max.

Physical

Housing: SPS glass-filled Crystalline Polymer
 Operating Temperature: -40 to +125°C

Circuits	Wire Range (AWG)	Mat-Seal Color	Order No.		Lead-free
			With CPA	Without CPA	
2	18-22	Red	19418-0008	19418-0016	Yes
	14-16	Blue	19418-0007	19418-0017	

MX150L™



5.84mm (.230") Pitch MX150L™ Plug

19419
Single Row

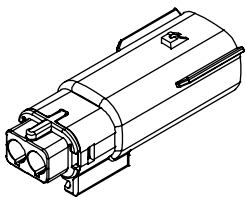

Features and Benefits

- Environmentally sealed to IP67
- Integrated interface seal and Terminal Position Assurance (TPA)
- Simple crimp and poke application
- Field serviceable contact removal system
- Tactile and audible mating feedback

Reference Information

Packaging: Bag
 UL File No.: E152602
 Mates With: 19418
 Use With: 19417
 Designed In: Inches

Electrical

Voltage: 600V
 Dielectric Withstanding Voltage: 2200V AC min.
 Insulation Resistance: 1000 Megohms

Mechanical

Mating Force: 75N max.
 Unmating Force: 75N max.

Physical

Housing: SPS glass-filled Crystalline Polymer
 Operating Temperature: -40 to +125°C

Circuits	Wire Range (AWG)	Mat-Seal Color	Order No.	Lead-free
2	18-22	Red	19419-0008	Yes
	14-16	Blue	19419-0007	

5.84mm (.230") Pitch MX150L™ Receptacle

19418
Dual Row

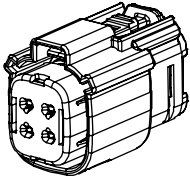

Features and Benefits

- Environmentally sealed to IP67
- Integrated interface seal and Terminal Position Assurance (TPA)
- Optional Connector Position Assurance (CPA)
- Simple crimp and poke application
- Field serviceable contact removal system
- Tactile and audible mating feedback

Reference Information

Packaging: Bag
 UL File No.: E152602
 Mates With: 19419, 19427, 19428,
 19429 and 19435
 Use With: 19420
 Designed In: Inches

Electrical

Voltage: 600V
 Dielectric Withstanding Voltage: 2200V AC min.
 Insulation Resistance: 1000 Megohms

Mechanical

Mating Force: 75N max.
 Unmating Force: 75N max.

Physical

Housing: SPS glass-filled Crystalline Polymer
 Operating Temperature: -40 to +125°C

MX150L™

G

Circuits	Wire Range (AWG)	Mat-Seal Color	Order No.		Lead-free
			With CPA	Without CPA	
4	18-22	Red	19418-0005	19418-0018	Yes
	14-16	Blue	19418-0004	19418-0019	
6	18-22	Red	19418-0011	19418-0020	
	14-16	Blue	19418-0010	19418-0021	
8	18-22	Red	19418-0001	19418-0022	
	14-16	Blue	19418-0002	19418-0023	
10	18-22	Red	19418-0014	19418-0024	
	14-16	Blue	19418-0013	19418-0025	
12	18-22	Red	19418-0026	19418-0038	
	14-16	Blue	19418-0027	19418-0037	
16	18-22	Red	19418-0029	19418-0040	
	14-16	Blue	19418-0030	19418-0039	

5.84mm (.230") Pitch MX150L™ Plug

19419
Dual Row

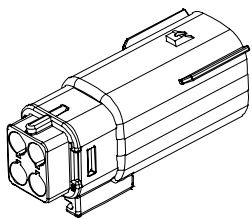

Features and Benefits

- Environmentally sealed to IP67
- Integrated interface seal and Terminal Position Assurance (TPA)
- Simple crimp and poke application
- Field serviceable contact removal system
- Tactile and audible mating feedback

Reference Information

Packaging: Bag
 UL File No.: E152602
 Mates With: 19418
 Use With: 19417
 Designed In: Inches

Electrical

Voltage: 600V
 Dielectric Withstanding Voltage: 2200V AC min.
 Insulation Resistance: 1000 Megohms

Mechanical

Mating Force: 75N max.
 Unmating Force: 75N max.

Physical

Housing: SPS glass-filled Crystalline Polymer
 Operating Temperature: -40 to +125°C

Circuits	Wire Range (AWG)	Mat-Seal Color	Order No.	Lead-free
4	18-22	Red	19419-0005	Yes
	14-16	Blue	19419-0004	
6	18-22	Red	19419-0012	
	14-16	Blue	19419-0011	
8	18-22	Red	19419-0001	
	14-16	Blue	19419-0002	
10	18-22	Red	19419-0015	
	14-16	Blue	19419-0014	
12	18-22	Red	19419-0017	
	14-16	Blue	19419-0018	
16	18-22	Red	19419-0020	
	14-16	Blue	19419-0021	

5.84mm (.230") Pitch MX150L™ Panel Mount Plug

19429
Rear Mount Flange
Single Row

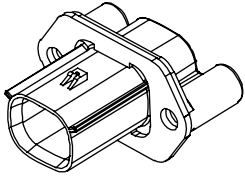

Features and Benefits

- Environmentally sealed to IP67 when mated
- Integrated Terminal Position Assurance (TPA)
- Simple crimp and poke application
- Field serviceable contact removal system
- Tactile and audible mating feedback
- For inside panel mount application
- Blind hole boss feature eliminates leak path and reduces extra sealing process during assembly
- Use with molded silicon panel gasket

Reference Information

Packaging: Bag
UL File No.: E152602
Mates With: 19418
Use With: 19417
Designed In: Inches

Electrical

Voltage: 600V
Dielectric Withstanding Voltage: 2200V AC min.
Insulation Resistance: 1000 Megohms

Mechanical

Mating Force: 75N max.
Unmating Force: 75N max.

Physical

Housing: SPS glass-filled Crystalline Polymer
Operating Temperature: -40 to +125°C

Circuits	Wire Range (AWG)	Order No.			Lead-free
		With Gasket	Without Gasket	Gasket	
2	14-22	19429-0033	19429-0005	19427-0025	Yes

Note: Recommended Mounting Hardware: (2) #10 x .62/18.9 long, plastic thread cutting screws
Suggested Source: ITW Shake Proof Industrial Bosscrew or equivalent

5.84mm (.230") Pitch MX150L™ Panel Mount Plug

19429
Through Hole Flange
Single Row

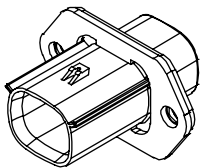

Features and Benefits

- Environmentally sealed to IP67 when mated
- Integrated Terminal Position Assurance (TPA)
- Simple crimp and poke application
- Field serviceable contact removal system
- Tactile and audible mating feedback
- For outside or inside panel mount application
- Use with molded silicon panel gasket

Reference Information

Packaging: Bag
UL File No.: E152602
Mates With: 19418
Use With: 19417
Designed In: Inches

Electrical

Voltage: 600V
Dielectric Withstanding Voltage: 2200V AC min.
Insulation Resistance: 1000 Megohms

Mechanical

Mating Force: 75N max.
Unmating Force: 75N max.

Physical

Housing: SPS glass-filled Crystalline Polymer
Operating Temperature: -40 to +125°C

Circuits	Wire Range (AWG)	Order No.			Lead-free
		With Gasket	Without Gasket	Gasket	
2	14-22	19429-0041	19429-0026	19427-0025	Yes

5.84mm (.230") Pitch MX150L™ Panel Mount Plug

19429
Rear Mount Flange
Dual Row

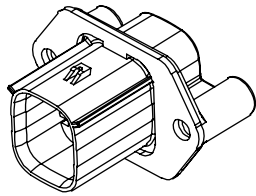

Features and Benefits

- Environmentally sealed to IP67 when mated
- Integrated Terminal Position Assurance (TPA)
- Simple crimp and poke application
- Field serviceable contact removal system
- Tactile and audible mating feedback
- For inside panel mount application
- Blind hole boss feature eliminates leak path and reduces extra sealing process during assembly
- Use with molded silicon panel gasket

Reference Information

Packaging: Bag
UL File No.: E152602
Mates With: 19418
Use With: 19417
Designed In: Inches

Electrical

Voltage: 600V
Dielectric Withstanding Voltage: 2200V AC min.
Insulation Resistance: 1000 Megohms

Mechanical

Mating Force: 75N max.
Unmating Force: 75N max.

Physical

Housing: SPS glass-filled Crystalline Polymer
Operating Temperature: -40 to +125°C

MX150L™

H

Circuits	Wire Range (AWG)	Order No.			Lead-free
		With Gasket	Without Gasket	Gasket	
4	14-22	19429-0035	19429-0009	19427-0024	Yes
6		19429-0036	19429-0010	19427-0021	
8		19429-0037	19429-0011	19427-0022	
10		19429-0038	19429-0014	19427-0029	
12		19429-0039	19429-0015	19427-0030	
14		19429-0040	19429-0016	19427-0023	
16					

Note: Recommended Mounting Hardware: (2) #10 x .62/18.9 long, plastic thread cutting screws
Suggested Source: ITW Shake Proof Industrial Bosscrew or equivalent

5.84mm (.230") Pitch MX150L™ Panel Mount Plug

19429
Through Hole Flange
Dual Row

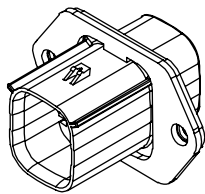

Features and Benefits

- Environmentally sealed to IP67 when mated
- Integrated Terminal Position Assurance (TPA)
- Simple crimp and poke application
- Field serviceable contact removal system
- Tactile and audible mating feedback
- For outside or inside panel mount application
- Use with molded silicon panel gasket

Reference Information

Packaging: Bag
UL File No.: E152602
Mates With: 19418
Use With: 19417
Designed In: Inches

Electrical

Voltage: 600V
Dielectric Withstanding Voltage: 2200V AC min.
Insulation Resistance: 1000 Megohms

Mechanical

Mating Force: 75N max.
Unmating Force: 75N max.

Physical

Housing: SPS glass-filled Crystalline Polymer
Operating Temperature: -40 to +125°C

Circuits	Wire Range (AWG)	Order No.			Lead-free
		With Gasket	Without Gasket	Gasket	
4	14-22	19429-0043	19429-0025	19427-0024	Yes
6		19429-0044	19429-0028	19427-0021	
8		19429-0045	19429-0029	19427-0022	
10		19429-0046	19429-0030	19427-0029	
12		19429-0047	19429-0031	19427-0030	
14		19429-0048	19429-0032	19427-0023	
16					

5.84mm (.230") Pitch MX150L™ Sealed Panel Mount Plug 19435 Rear Mount Flange Dual Row

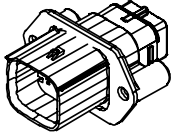

Features and Benefits

- Environmentally sealed to IP67
- Supports non-closed in panels
- Field serviceable contact removal system
- Tactile and audible mating feedback
- Blind hole boss feature eliminates leak path and reduces extra sealing process during assembly

Reference Information

Packaging: Bag
UL File No.: E152602
Mates With: 19418
Use With: 19417
Designed In: Inches

Electrical

Voltage: 600V
Dielectric Withstanding Voltage: 2200V AC min.
Insulation Resistance: 1000 Megohms

Mechanical

Mating Force: 75N max.
Unmating Force: 75N max.

Physical

Housing: Glass-filled PBT
Operating Temperature: -40 to +125°C

Circuits	Wire Range (AWG)	Mat-Seal Color	Order No.		Lead-free
			With Gasket	Without Gasket	
6	18-22	Red	19435-0612	19435-0614	Yes
	14-16	Blue	19435-0611	19435-0613	
8	18-22	Red	19435-0812	19435-0814	
	14-16	Blue	19435-0811	19435-0813	
10	18-22	Red	19435-1012	19435-1014	
	14-16	Blue	19435-1011	19435-1013	
12	18-22	Red	19435-1212	19435-1214	
	14-16	Blue	19435-1211	19435-1213	

Note: Recommended Mounting Hardware: (2) #10 x .62/18.9 long, plastic thread cutting screws
Suggested Source: ITW Shake Proof Industrial Bosscrew or equivalent

MX150L™

G

5.84mm (.230") Pitch MX150L™ PCB Header 19427 Right Angle with PCB Flange Single Row

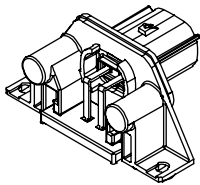

Features and Benefits

- Environmentally sealed to IP67
- Molded silicon panel gasket included
- Available in tin or gold plating
- Supports 14 to 22 AWG receptacles
- Tactile and audible mating feedback
- Blind hole boss feature eliminates leak path and reduces extra sealing process during assembly

Reference Information

Packaging: Tray
UL File No.: E152602
Mates With: 19418
Designed In: Inches

Electrical

Voltage: 600V
Dielectric Withstanding Voltage: 2200V AC min.
Insulation Resistance: 1000 Megohms

Mechanical

Durability: Tin Plating—25 cycles
Gold Plating—100 cycles

Physical

Housing: Glass-filled PBT
Contact: Copper Alloy
Plating: Contact Area—Tin or Gold
Solder Tail Area—Tin
PCB Thickness: 1.60mm (.062") max.
Operating Temperature: -40 to +125°C

Circuits	Order No.		Lead-free
	Tin	Select Gold/Tin	
2	19427-0094	19427-0110	Yes

Note: Recommended Mounting Hardware: (2) #10 x .62/18.9 long, plastic thread cutting screws
Suggested Source: ITW Shake Proof Industrial Bosscrew or equivalent

5.84mm (.230") Pitch MX150L™ PCB Header

19427
Right Angle
without PCB Flange
Single Row

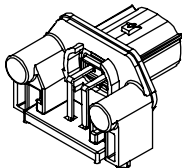

Features and Benefits

- Environmentally sealed to IP67
- Molded silicon panel gasket included
- Available in tin or gold plating
- Supports 14 to 22 AWG receptacles
- Tactile and audible mating feedback
- Blind hole boss feature eliminates leak path and reduces extra sealing process during assembly

Reference Information

Packaging: Tray
UL File No.: E152602
Mates With: 19418
Designed In: Inches

Electrical

Voltage: 600V
Dielectric Withstanding Voltage: 2200V AC min.
Insulation Resistance: 1000 Megohms

Mechanical

Durability: Tin Plating—25 cycles
Gold Plating—100 cycles

Physical

Housing: Glass-filled PBT
Contact: Copper Alloy
Plating: Contact Area—Tin or Gold
Solder Tail Area—Tin
PCB Thickness: 1.60mm (.062") max.
Operating Temperature: -40 to +125°C

MX150L™

G

Circuits	Order No.		Lead-free
	Tin	Select Gold/Tin	
2	19427-0040	19427-0109	Yes

Note: Recommended Mounting Hardware: (2) #10 x .62/18.9 long, plastic thread cutting screws
Suggested Source: ITW Shake Proof Industrial Bosscrew or equivalent

5.84mm (.230") Pitch MX150L™ PCB Header

19427
Right Angle
with PCB Flange
Dual Row

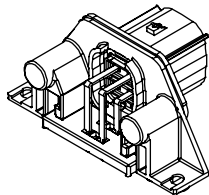

Features and Benefits

- Environmentally sealed to IP67
- Molded silicon panel gasket included
- Available in tin or gold plating
- Supports 14 to 22 AWG receptacles
- Tactile and audible mating feedback
- Blind hole boss feature eliminates leak path and reduces extra sealing process during assembly

Reference Information

Packaging: Tray
UL File No.: E152602
Mates With: 19418
Designed In: Inches

Electrical

Voltage: 600V
Dielectric Withstanding Voltage: 2200V AC min.
Insulation Resistance: 1000 Megohms

Mechanical

Durability: Tin Plating—25 cycles
Gold Plating—100 cycles

Physical

Housing: Glass-filled PBT
Contact: Copper Alloy
Plating: Contact Area—Tin or Gold
Solder Tail Area—Tin
PCB Thickness: 1.60mm (.062") max.
Operating Temperature: -40 to +125°C

Circuits	Order No.		Lead-free
	Tin	Select Gold/Tin	
4	19427-0096	19427-0112	Yes
6	19427-0097	19427-0113	
8	19427-0098	19427-0114	
10	19427-0099	19427-0115	
12	19427-0100	19427-0116	
14	19427-0101	19427-0117	
16	19427-0101	19427-0117	

Note: Recommended Mounting Hardware: (2) #10 x .62/18.9 long, plastic thread cutting screws
Suggested Source: ITW Shake Proof Industrial Bosscrew or equivalent

5.84mm (.230") Pitch MX150L™ PCB Header

19427 Right Angle without PCB Flange Dual Row

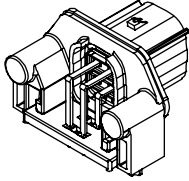

Features and Benefits

- Environmentally sealed to IP67
- Molded silicon panel gasket included
- Available in tin or gold plating
- Supports 14 to 22 AWG receptacles
- Tactile and audible mating feedback
- Blind hole boss feature eliminates leak path and reduces extra sealing process during assembly

Reference Information

Packaging: Tray
UL File No.: E152602
Mates With: 19418
Designed In: Inches

Electrical

Voltage: 600V
Dielectric Withstanding Voltage: 2200V AC min.
Insulation Resistance: 1000 Megohms

Mechanical

Durability: Tin Plating—25 cycles
Gold Plating—100 cycles

Physical

Housing: Glass-filled PBT
Contact: Copper Alloy
Plating: Contact Area—Tin or Gold
Solder Tail Area—Tin
PCB Thickness: 1.60mm (.062") max.
Operating Temperature: -40 to +125°C

Circuits	Order No.		Lead-free
	Tin	Select Gold/Tin	
4	19427-0032	19427-0107	Yes
6	19427-0018	19427-0106	
8	19427-0017	19427-0105	
10	19427-0031	19427-0104	
12	19427-0012	19427-0103	
16	19427-0049	19427-0102	

Note: Recommended Mounting Hardware: (2) #10 x .62/18.9 long, plastic thread cutting screws
Suggested Source: ITW Shake Proof Industrial Bosscrew or equivalent

5.84mm (.230") Pitch MX150L™ PCB Header

19428 Vertical Low Profile Single Row

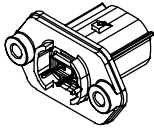

Features and Benefits

- Environmentally sealed to IP67
- Molded silicon panel gasket included
- Available in tin or gold plating
- Supports 14 to 22 AWG receptacles
- Tactile and audible mating feedback

Reference Information

Packaging: Tray
UL File No.: E152602
Mates With: 19418
Designed In: Inches

Electrical

Voltage: 600V
Dielectric Withstanding Voltage: 2200V AC min.
Insulation Resistance: 1000 Megohms

Mechanical

Durability: Tin Plating—25 cycles
Gold Plating—100 cycles

Physical

Housing: Glass-filled PBT
Contact: Copper Alloy
Plating: Contact Area—Tin or Gold
Solder Tail Area—Tin
PCB Thickness: 1.60mm (.062") max.
Operating Temperature: -40 to +125°C

Circuits	Order No.		Lead-free
	Tin	Select Gold/Tin	
2	19428-0009	19428-0025	Yes

Note: Recommended Mounting Hardware: (2) #10 x .62/18.9 long, plastic thread cutting screws
Suggested Source: ITW Shake Proof Industrial Bosscrew or equivalent

5.84mm (.230") Pitch MX150L™ PCB Header

19428
Vertical
Standard Profile
Single Row

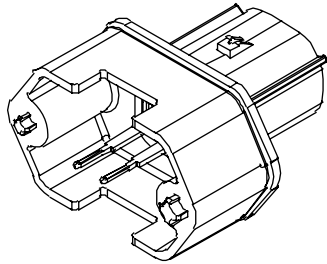

Features and Benefits

- Environmentally sealed to IP67
- Molded silicon panel gasket included
- Available in tin or gold plating
- Supports 14 to 22 AWG receptacles
- Tactile and audible mating feedback

Reference Information

Packaging: Tray
UL File No.: E152602
Mates With: 19418
Designed In: Inches

Electrical

Voltage: 600V
Dielectric Withstanding Voltage: 2200V AC min.
Insulation Resistance: 1000 Megohms

Mechanical

Durability: Tin Plating—25 cycles
Gold Plating—100 cycles

Physical

Housing: Glass-filled PBT
Contact: Copper Alloy
Plating: Contact Area—Tin or Gold
Solder Tail Area—Tin
PCB Thickness: 1.60mm (.062") max.
Operating Temperature: -40 to +125°C

MX150L™



Circuits	Order No.		Lead-free
	Tin	Select Gold/Tin	
2	19428-0007	19428-0017	Yes

Note: Recommended Mounting Hardware: (2) #10 x .62/18.9 long, plastic thread cutting screws
Suggested Source: ITW Shake Proof Industrial Bosscrew or equivalent

5.84mm (.230") Pitch MX150L™ PCB Header

19428
Vertical
Low Profile
Dual Row

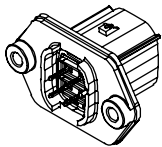

Features and Benefits

- Environmentally sealed to IP67
- Molded silicon panel gasket included
- Available in tin or gold plating
- Supports 14 to 22 AWG receptacles
- Tactile and audible mating feedback

Reference Information

Packaging: Tray
UL File No.: E152602
Mates With: 19418
Designed In: Inches

Electrical

Voltage: 600V
Dielectric Withstanding Voltage: 2200V AC min.
Insulation Resistance: 1000 Megohms

Mechanical

Durability: Tin Plating—25 cycles
Gold Plating—100 cycles

Physical

Housing: Glass-filled PBT
Contact: Copper Alloy
Plating: Contact Area—Tin or Gold
Solder Tail Area—Tin
PCB Thickness: 1.60mm (.062") max.
Operating Temperature: -40 to +125°C

Circuits	Order No.		Lead-free
	Tin	Select Gold/Tin	
4	19428-0011	19428-0027	Yes
6	19428-0012	19428-0028	
8	19428-0013	19428-0029	
10	19428-0014	19428-0030	
12	19428-0015	19428-0031	
16	19428-0016	19428-0032	

5.84mm (.230") Pitch MX150L™ PCB Header

19428
Vertical
Standard Profile
Dual Row

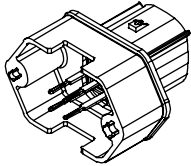

Features and Benefits

- Environmentally sealed to IP67
- Molded silicon panel gasket included
- Available in tin or gold plating
- Supports 14 to 22 AWG receptacles
- Tactile and audible mating feedback

Reference Information

Packaging: Tray
UL File No.: E152602
Mates With: 19418
Designed In: Inches

Electrical

Voltage: 600V
Dielectric Withstanding Voltage: 2200V AC min.
Insulation Resistance: 1000 Megohms

Mechanical

Durability: Tin Plating—25 cycles
Gold Plating—100 cycles

Physical

Housing: Glass-filled PBT
Contact: Copper Alloy
Plating: Contact Area—Tin or Gold
Solder Tail Area—Tin
PCB Thickness: 1.60mm (.062") max.
Operating Temperature: -40 to +125°C

Circuits	Order No.		Lead-free
	Tin	Select Gold/Tin	
4	19428-0006	19428-0019	Yes
6	19428-0004	19428-0020	
8	19428-0003	19428-0021	
10	19428-0005	19428-0022	
12	19428-0001	19428-0023	
16	19428-0002	19428-0024	

Note: Recommended Mounting Hardware: (2) #10 x .62/18.9 long, plastic thread cutting screws
Suggested Source: ITW Shake Proof Industrial Bosscrew or equivalent

MX150L™

G

7.62mm (.300") Pitch MX150L™ Terminal

19434
8, 10, 12 AWG
Female

Features and Benefits

- Mat-seal friendly design features center seam and coined edges
- High-current
- Low insertion force

Reference Information

Packaging: Bag, reel
UL File No.: E152602
Use With: 19432
Designed In: Inches

Electrical

Current: 10-12 AWG—30.0A
8 AWG—40.0A

Mechanical

Contact Insertion Force: 1lb max.
Durability: 25 cycles

Physical

Contact: Copper Alloy
Plating: Tin

MX150L™

G

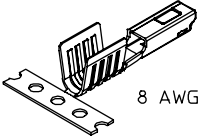
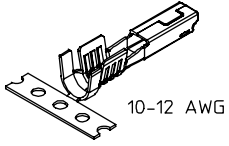

Wire Range AWG	Insulation Diameter mm (in)	Order No.		Lead-free
		Strip	Loose	
10-12	3.94-4.45 (.155 - .175)	19434-0001	19434-0003	Yes
8	.602 (.237)	19434-0002	19434-0004	

7.62mm (.300") Pitch MX150L™ Terminal

19431
8, 10, 12 AWG
Male

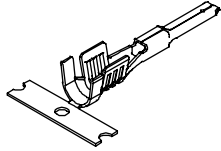

10-12 AWG

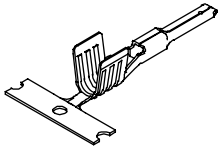

8 AWG

Features and Benefits

- Mat-seal friendly design features center seam and coined edges
- High-current
- Low insertion force

Reference Information

Packaging: Bag or reel
UL File No.: E1 52602
Use With: 19433
Designed In: Inches

Electrical

Current: 10-12 AWG—30.0A
8 AWG—40.0A

Mechanical

Contact Insertion Force: 1 lb max.
Durability: 25 cycles

Physical

Contact: Copper Alloy
Plating: Tin

Wire Range AWG	Insulation Diameter mm (in)	Order No.		Lead-free
		Strip	Loose	
10-12	3.94-4.45 (.155-.175)	19431-0001	19431-0016	Yes
8	6.02 (.237)	19431-0015	19431-0017	

7.62mm (.300") Pitch MX150L™ Receptacle

19432
8, 10, 12 AWG
Single Row

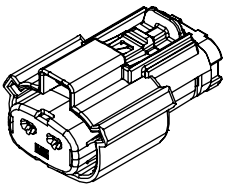

Features and Benefits

- Environmentally sealed to IP67
- Integrated mat-wire seal and Terminal Position Assurance (TPA)
- High-current
- Connector Position Assurance (CPA) included
- Simple crimp and poke application
- Field serviceable contact removal system
- Tactile and audible mating feedback

Reference Information

Packaging: Tray
UL File No.: E1 52602
Mates With: 19433
Use With: 19434
Designed In: Inches

Electrical

Voltage: 600V
Dielectric Withstanding Voltage: 2200V AC min.
Insulation Resistance: 1000 Megohms

Mechanical

Mating Force: 75N max.
Unmating Force: 75N max.

Physical

Housing: Glass-filled PBT
Operating Temperature: -40 to +125°C

Circuits	Wire Range (AWG)	Mat-Seal Color	Order No.	Lead-free
2	10-12	Yellow	19432-0013	Yes
	8	Red	19432-0014	

7.62mm (.300") Pitch MX150L™ Plug

19433
8, 10, 12 AWG
Single Row

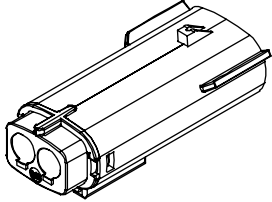

Features and Benefits

- Environmentally sealed to IP67
- Integrated interface seal and Terminal Position Assurance (TPA)
- High-current
- Simple crimp and poke application
- Field serviceable contact removal system
- Tactile and audible mating feedback

Reference Information

Packaging: Bag
UL File No.: E152602
Mates With: 19432
Use With: 19431
Designed In: Inches

Electrical

Voltage: 600V
Dielectric Withstanding Voltage: 2200V AC min.
Insulation Resistance: 1000 Megohms

Mechanical

Mating Force: 75N max.
Unmating Force: 75N max.

Physical

Housing: Glass-filled PBT
Operating Temperature: -40 to +125°C

MX150L™

G

Circuits	Wire Range (AWG)	Mat-Seal Color	Order No.	Lead-free
2	10-12	Yellow	19433-0013	Yes
	8	Red	19433-0014	

7.62mm (.300") Pitch MX150L™ Receptacle

19432
8, 10, 12 AWG
Dual Row

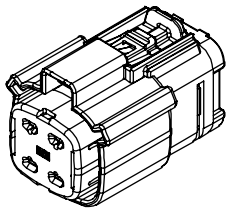

Features and Benefits

- Environmentally sealed to IP67
- Integrated mat-wire seal and Terminal Position Assurance (TPA)
- High-current
- Simple crimp and poke application
- Field serviceable contact removal system
- Tactile and audible mating feedback

Reference Information

Packaging: Tray
UL File No.: E152602
Mates With: 19433
Use With: 19434
Designed In: Inches

Electrical

Voltage: 600V
Dielectric Withstanding Voltage: 2200V AC min.
Insulation Resistance: 1000 Megohms

Mechanical

Mating Force: 75N max.
Unmating Force: 75N max.

Physical

Housing: Glass-filled PBT
Operating Temperature: -40 to +125°C

Circuits	Wire Range (AWG)	Mat-Seal Color	Order No.	Lead-free
4	10-12	Yellow	19432-0001	Yes
	8	Red	19432-0002	

7.62mm (.300") Pitch MX150L™ Plug

19433
8, 10, 12 AWG
Dual Row

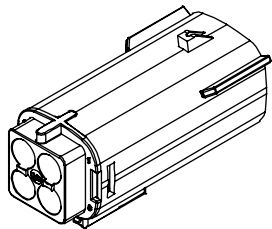

Features and Benefits

- Environmentally sealed to IP67
- Integrated mat-wire seal and Terminal Position Assurance (TPA)
- High-current
- Simple crimp and poke application
- Field serviceable contact removal system
- Tactile and audible mating feedback

Reference Information

Packaging: Bag
UL File No.: E152602
Mates With: 19432
Use With: 19431
Designed In: Inches

Electrical

Voltage: 600V
Dielectric Withstanding Voltage: 2200V AC min.
Insulation Resistance: 1000 Megohms

Mechanical

Mating Force: 75N max.
Unmating Force: 75N max.

Physical

Housing: Glass-filled PBT
Operating Temperature: -40 to +125°C

Circuits	Wire Range (AWG)	Mat-Seal Color	Order No.	Lead-free
4	10-12	Yellow	19433-0001	Yes
	8	Red	19433-0002	

5.84mm (.230") Pitch MX150L™ Unused Cavity Circuit Plug

19417
14 to 22 AWG

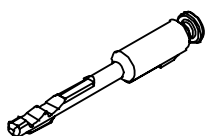

Features and Benefits

- Supports the ability to implement sealed blank cavities in plug and receptacle housings
- Circuit plugs fully seal the unused cavity
- Easily extracted and replaced with a standard male blade or female receptacle terminal
- Provides ability to plan for possible future circuit additions while maintaining the sealing integrity of the mated pair

Reference Information

Packaging: Bag
UL File No.: E152602
Use With: 19418, 19419 and 19435
Designed In: Inches

Physical

Material: SPS glass-filled Crystalline Polymer
Operating Temperature: -40 to +125°C

Housing Series	Order No.	Lead-free
19418	19417-0119	Yes
19419	19417-0119	
19435	19417-0119	

7.62mm (.300") Pitch MX150L™ Unused Cavity Circuit Plug

19431
8, 10, 12 AWG

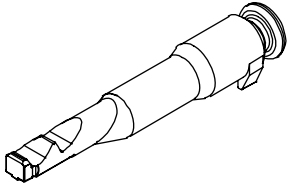

Features and Benefits

- Supports the ability to implement sealed blank cavities in plug and receptacle housings
- Circuit plugs fully seal the unused cavity
- Easily extracted and replaced with a standard male blade or female receptacle terminal
- Provides ability to plan for possible future circuit additions while maintaining the sealing integrity of the mated pair

Reference Information

Packaging: Bag
UL File No.: E152602
Use With: 19433 and 19432
Designed In: Inches

Physical

Material: Glass-filled PBT
Operating Temperature: -40 to +125°C

MX150L™

G

Housing Series	Order No.	Lead-free
19433	19431-0013	Yes
19432	19431-0013	

SCPCH-1 to H-7
Beau™ Plug and Socket ConnectorsH-8 to H-15

Self-Contained Power Connectors

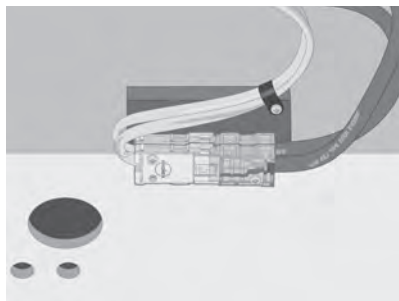

Self-Contained Power Connectors (SCPC) from Molex are used to splice and tap solid and stranded nonmetallic sheathed cable and SEOW/SJEW type cable. This connector family supports two and three conductor circuits plus ground for AC power applications. The splice connectors are used for splicing two cable segments together and replace butt connectors, wire nuts and junction boxes used in traditional splice applications. Tap connectors are used for splicing into existing solid conductor cable with ground. Panel mount connectors allow OEMs to incorporate a pluggable electrical power interface into any equipment requiring 110V AC power normally supplied over nonmetallic sheathed copper cable. These connectors, as well as dust/safety covers and available weather tight boots, offer a host of features and benefits.

Self-Contained Power Connectors incorporate a hermaphroditic design meaning it mates with itself so there is only one part to order and inventory.

SCPC feature insulation displacement contacts which provide wire termination without the need to pre-strip the wires. The high impact crystal clear strain relief cover provides durability and allows for complete visual inspection.

Housings have a large markable surface area for easy circuit identification. The simple two-piece construction provides for ease of use and eliminates the worry of losing small parts. The double latching system provides positive connection security when required, but is fully releasable so the connectors can be mated and unmated as needed.

Dust or safety caps protect unmated circuits from damage due to dust and dirt accumulation, as well as prevent accidental shock. These caps also allow SCPC to be implemented into designs and remain unmated for future use. Weather tight boots are ideal for connectors that will be exposed to rain and spray. These boots slip easily over mated connectors with no special tools required.

Solid Cable Applications

Typical connector applications for the solid cable style connectors include cross-over electrical connections for pre-wired, pre-fabricated/modular structures and homes. With this connector system, manufactured housing OEMs can safely and easily implement modular electrical systems within the structures at the factory and then quickly plug them together at the home site.

Stranded Cable Applications

Typical connector applications for the stranded cable style connectors include splices and taps used for AC power applications in the marine industry. With SCPC, marine OEMs can manufacture discrete modules for staterooms, salons and galleys and plug them together into the same electrical system as the modules are dropped into the hull further down the manufacturing line.

Applications:

- Non-Automotive Transportation
 - RV/RV Slide outs
 - Marine Industry
- Modular homes
- Office partitions
- Smoke detectors
- Three-way lighting

Self-Contained Power Connectors for Solid and Stranded Nonmetallic Sheathed Cables

19045, 19401, 19403 Splice Connectors

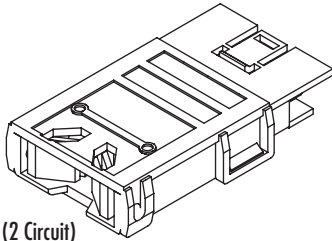

(2 Circuit)

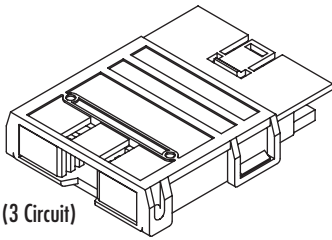

(3 Circuit)

Features and Benefits

- Double-latching system provides positive connection security and is fully releasable so the connector can be mated and unmated as needed
- Markable surface area on housing allows for easy circuit identification
- Hermaphroditic design mates with itself so there is only one part to order and inventory
- High impact crystal clear strain relief cover provides durability and allows for complete visual inspection
- Two-circuit connectors are used to wire home, buildings, office partitions, RVs, motor homes and many more electrical applications using 110 and 220V AC circuits.
- Three-circuit connector generally used for wiring smoke detectors, 3-way lighting and entertainment centers

Reference Information

Packaging: Box
 UL File No.: E182087 (12 to 16 AWG)
 E217798 (10 AWG non-marine)
 E196349 (10 AWG marine)
 CSA File No.: LR18689-C53
 NEC Article: 550-10K and 545-13
 HUD Section: 3280.801
 Mates With: 19045, 19402, 19403, 19421 and 19424
 Designed In: Inches

Electrical

Voltage: 300V
 Current: 12 to 16 AWG—20.0A
 10 AWG—30.0A

Mechanical

Mating Force: 93.41N (21 lb)
 Unmating Force: 39.14N (8.80 lb)
 Durability: 250 cycles

Physical

Housing: PBT
 Contact: Copper Alloy
 Plating: Contact Area—Tin
 Wire Range: 10 to 16 AWG
 Operating Temperature: -35°C to +105°C

Circuits	Wire Range (AWG)	Cable Type	Housing Color	Order No.	Lead-free
2	12-14	Solid	White	19045-1000	Yes
	10			19403-1300	
	14-16	Stranded	Blue	19403-1011	
	12		Yellow	19403-1010	
	10		White	19403-1300	
3	12-14	Solid	White	19401-1000	

Note: For application tooling visit www.molex.com

Self-Contained Power Connectors for Round Stranded SEOW/SJEW Cables

19403/19421 Splice Connectors

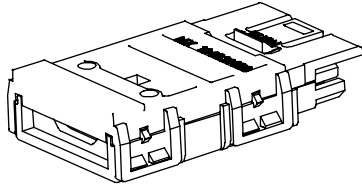

Power Connectors



Features and Benefits

- Double-latching system provides positive connection security and is fully releasable so the connector can be mated and unmated as needed
- Mates with standard Self-Contained Power Connector products including the tap version, and provides a simple and reliable method for transitioning from solid nonmetallic cable to stranded SEOW/SJEW type cable
- Markable surface area on housing allows for easy circuit identification
- Two-circuit SEOW/SJEW versions specifically engineered to accommodate round jacketed, stranded conductor power cords typically found in RV slide-out manufacturing applications

Reference Information

Packaging: Box
 UL File No.: E182087 (12 to 16 AWG)
 CSA File No.: LR18689-C53
 NEC Article: 550-10K and 545-13
 HUD Section: 3280.801
 Mates With: 19045, 19402, 19403, 19421 and 19424
 Designed In: Inches

Electrical

Voltage: 600V
 Current: 20.0A

Mechanical

Mating Force: 93.41N (21lb)
 Unmating Force: 39.14N (8.80 lb)
 Durability: 250 cycles

Physical

Housing: PBT
 Contact: Copper Alloy
 Plating: Contact Area—Tin
 Wire Range: 12 to 14 AWG
 Operating Temperature: -35°C to +105°C

Circuits	Wire Range (AWG)	Insulation Diameter Mm (in.)	Housing Color	Cover Color	Order No.	Lead-free
2	14	8.64-11.18mm (.340-.440")	White	Clear	19403-1310	Yes
		15.24mm (.600")		Blue	19403-0011	
	12	8.64-11.18mm (.340-.440")	Yellow	Clear	19421-0001	
		15.24mm (.600")		Blue	19421-0002	

Note: For application tooling visit www.molex.com

Self-Contained Power Connector Accessories

19045/19402/19403
19425/19426

Weathertight Boots and Covers

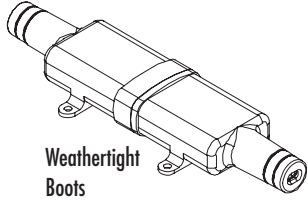

Weathertight Boots

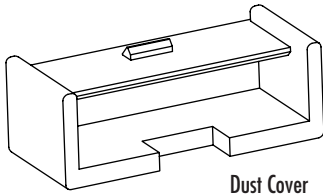

Dust Cover

Features and Benefits

- Weathertight boots provide effective protection against water ingress when exposed to rain and spray
- Boots slide over mated connectors eliminating the need for special tools
- Dust cover and safety cap allow unmated SCPC to be implemented into designs for future use
- Caps can be used on both splice and tap connectors

Reference Information

Packaging: Box
UL File No.: E182087
Use With: 2-circuit SCPC
Designed In: Inches

Physical

Boots: Thermoplastic
Covers: PBT
Wire Gauge: 10 to 16 AWG
Operating Temperature: -35°C to +105°C

Weathertight Boots

Cable Type	Wire Range (AWG)	Gender	Order No.	Lead-free
Marine Stranded	12-16	Male	19403-1060	Yes
	12-16	Female	19403-1061	
	10	Male	19403-0008	
	10	Female	19403-0009	
Solid	12-14	Male	19425-0001	
	12-14	Female	19425-0002	
Round Stranded	12-14	Male	19426-0001	
	12-14	Female	19426-0002	

Note: Male and female versions of weathertight boots are interchangeable (e.g. solid cable male boot will mate with a round stranded female boot)

Covers

Description	Order No.	Lead-free
Safety cap	19045-3180	Yes
Dust cover	19402-5000	

Self-Contained Power Connectors for Solid and Stranded Nonmetallic Sheathed Cables

19402 Tap Connectors

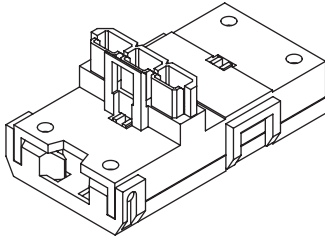

Features and Benefits

- Double-latching system provides positive connection security and is fully releasable so the connector can be mated and unmated as needed
- Markable surface area on housing allows for easy circuit identification
- Hermaphroditic design mates with itself so there is only one part to order and inventory
- High impact crystal clear strain relief cover provides durability and allows for complete visual inspection
- Two-circuit connectors are used to wire home, buildings, office partitions, RVs, motor homes and many more electrical applications using 110 and 220V AC circuits.
- Three-circuit connector generally used for wiring smoke detectors, 3-way lighting and entertainment centers

Reference Information

Packaging: Box
 UL File No.: E182087 (12 to 16 AWG)
 CSA File No.: LR18689-C53
 NEC Article: 550-10K and 545-13
 HUD Section: 3280.801
 Mates With: 19045, 19403 and 19421
 Designed In: Inches

Electrical

Voltage: 300V
 Current: 20.0A

Mechanical

Mating Force: 93.41N (21 lb)
 Unmating Force: 39.14N (8.80 lb)
 Durability: 250 cycles

Physical

Housing: PBT
 Contact: Copper Alloy
 Plating: Contact Area—Tin
 Wire Range: 12 to 16 AWG
 Operating Temperature: -35°C to +105°C

Circuits	Wire Range (AWG)	Cable Type	Order No.	Lead-free
2	12-14	Solid	19402-1000	Yes
	14-16	Stranded	19402-1011	
	12		19402-1010	

Note: For application tooling visit www.molex.com

Self-Contained Power Connector Splitter Box

19424

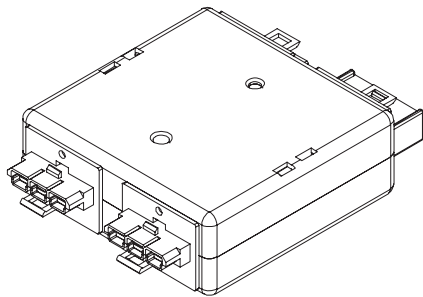

Features and Benefits

- Double-latching system provides positive connection security and is fully releasable so the connector can be mated and unmated as needed
- SCPC Splitter Box supports modular wiring applications common in OEM manufactured housing, marine and RV industries
- Enables efficient 110V, 20.0A power distribution using a convenient low-profile junction system compatible with the standard SCPC connector interface

Reference Information

Packaging: Tray
 UL File No.: E152602
 Mates With: 19045, 19403 and 19421
 Designed In: Inches

Electrical

Voltage: 600V
 Current: 20.0A
 Dielectric Withstanding Voltage: 1600V

Mechanical

Mating Force: 93.41N (21 lb)
 Unmating Force: 39.14N (8.80 lb)
 Durability: 250 cycles

Physical

Housing: PBT
 Contact: Copper Alloy
 Plating: Contact Area—Tin
 Wire Range: 12 to 14 AWG
 Operating Temperature: -35°C to +105°C

Wire Range (AWG)	Cable Type	Housing Color	Order No.	Lead-free
12-14	Solid or stranded	White	19424-0002	Yes

Self-Contained Power Connector Panel Mount Housing

19403

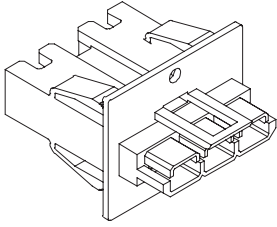

Features and Benefits

- Double-latching system provides positive connection security and is fully releasable so the connector can be mated and unmated as needed
- Panel mount connector allows OEMs to incorporate a pluggable electrical power interface into any equipment requiring 110V AC power normally supplied over nonmetallic sheathed copper cable
- Crimp-on electrical contacts are compatible with both stranded and solid wire

Reference Information

Packaging: Box
 UL File No.: 152602
 CSA File No.: LR18689-C53
 Flammability: UL 94-5VA
 Mates With: 19403
 Use With: 19403 Terminals
 Designed In: Inches

Electrical

Voltage: 300V
 Current: 12 to 14 AWG—20.0A
 10 AWG—30.0A
 Dielectric Withstanding Voltage: 1600V

Mechanical

Mating Force: 93.41N (21lb)
 Unmating Force: 39.14N (8.80 lb)
 Durability: 250 cycles

Physical

Housing: PBT
 Contact: Copper Alloy
 Plating: Contact Area—Tin
 Wire Range: 10 to 14 AWG
 Operating Temperature: -35°C to +105°C

Circuits	Wire Range (AWG)	Order No.	Lead-free
2	12-14	19403-1120	Yes
	10	19403-1230	

Self-Contained Power Connector Terminals

19403

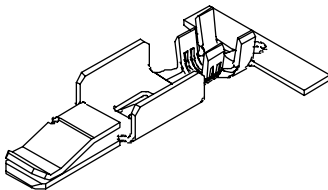

Features and Benefits

- Crimp-on electrical terminals are compatible with solid and stranded wire

Reference Information

Packaging: Bag, Reel
 UL File No.: E152602
 Use With: 19403 panel mount housing
 Designed In: Inches

Electrical

Voltage: 300V
 Current: 12 to 14 AWG—20.0A
 10 AWG—30.0A

Mechanical

Contact Insertion Force: 4.45N (1.0 lb max.)
 Insulation Diameter:
 12 to 14 AWG—3.48 to 4.11mm (.137 to .162")
 10 AWG—4.70mm (.185")
 Durability: 25 cycles

Physical

Contact: Copper Alloy
 Plating: Tin

Wire Range AWG	Order No.		Lead-free
	Reel	Loose	
12-14	19403-1130	19403-1131	Yes
10	19403-1240	19403-1241	

Note: For application tooling visit www.molex.com

Beau™ Power Connectors Panel and Cable Mount Plugs and Sockets



Beau plug and socket blade-type connectors from Molex offer extremely high reliability. These unique flat blade connectors provide superior durability over hollow pin connectors. The flat blade design is harder and has more mass than hollow pins allowing them to be mated again and again without damage. These products are often used in applications that require 20-year longevity in ordinary environments.

Thermoplastic backshells provide greater dielectric strength and safety. These backshells resist scuffing, abrasion, most acids and alkalis and are also rustproof.

Uniform float contacts allow for maximum surface engagement and easier mating.

This exceptional design results in low contact resistance and high current carrying capacity.

The variety of contact tails and hardware options allow you to design a part to meet your specific design requirements. For options regarding contact tails and hardware not found in this catalog, contact Molex for availability and order numbers.

Applications:

- Traffic control
- Vending machines
- DC motor

Contact Molex for order numbers using contact tails other than the standard.

Contact Tails Available for series 38330 and 38331

Contact Tail Styles	Contact Tail Length	Hole Diameter/Quick Connect Size	
Solder Eye*	7.62mm (.300")	1.78 x 2.54mm (.070 x .100")	
Solder Eye	5.59mm (.220")	1.78 x 2.54mm (.070 x .100")	
Wire Wrap	9.65mm (.380")		
Quick Connect (single hole)	9.91mm (.390")	2.79 x 0.51mm (.110 x .020")	
Quick Connect (double hole)	5.59mm (.220")	2.79 x 0.51mm (.110 x .020")	
Printed Circuit	6.35mm (.250")		

*Standard contact tail

Contact Tails Available for series 38540, 38541 and 38542

Contact Tail Style	Contact Tail Length	Hole/Quick Connect Size	
Solder Hook*	7.11mm (.280")		
Solder Eye	8.38mm (.330")	3.56mm (.140")	
	6.35mm (.250")	3.30 x 4.06mm (.130 x .160")	
Solder Eye and Quick Connect	6.35mm (.250")	2.29mm (.090")	
	6.35mm (.250")	4.06mm (.160")	
Quick Connect	8.38mm (.330")	5.21 x 0.81mm (.205 x .032")	
	8.38mm (.330")	4.75 x 0.81mm (.187 x .032")	
Printed Circuit	9.65mm (.380")		
	6.35mm (.250")		

*Standard contact tail for plugs

Beau™ Power Connectors Panel Mount Plugs and Sockets

38330

**Angle Bracket,
Angle Bracket Tapped,
Without Angle Bracket**



Angle Bracket shown

Features and Benefits

- Robust blade contacts resist damage from improper mating
- Large surface area of dual wipe female contact produces maximum current capacity
- All circuits are rated for full current load

Reference Information

Packaging: Tray
UL File No.: E34763
CSA File No.: 22156
Designed In: Inches

Electrical

Voltage: 250V
Current: 10.0A

Mechanical

Durability: 500 cycles

Physical

Housing: Phenolic
Plug Contact: Brass
Socket Contact: Phosphor Bronze
Plating: Plug Contact—Tin
Socket Contact—Tin
Operating Temperature: 150°C

Plugs

Circuits	Order No.			Lead-free
	Angle Bracket	Angle Bracket Tapped	Without Angle Bracket	
2	38330-0102	38330-1502	38330-2202	Yes
3	38330-0103	38330-1503	38330-2203	
4	38330-0104	38330-1504	38330-2204	
6	38330-0106	38330-1506	38330-2206	
8	38330-0108	38330-1508	38330-2208	
10	38330-0110	38330-1510	38330-2210	
12	38330-0112	38330-1512	38330-2212	
15	38330-0115	38330-1515	38330-2215	
18	38330-0118	38330-1518	38330-2218	
21	38330-0121	38330-1521	38330-2221	
24	38330-0124	38330-1524	38330-2224	
27	38330-0127	38330-1527	38330-2227	
30	38330-0130	38330-1530	38330-2230	
33	38330-0133	38330-1533	38330-2233	

Sockets

Circuits	Order No.			Lead-free
	Angle Bracket	Angle Bracket Tapped	Without Angle Bracket	
2	38330-0502	38330-1902	38330-2602	Yes
3	38330-0503	38330-1903	38330-2603	
4	38330-0504	38330-1904	38330-2604	
6	38330-0506	38330-1906	38330-2606	
8	38330-0508	38330-1908	38330-2608	
10	38330-0510	38330-1910	38330-2610	
12	38330-0512	38330-1912	38330-2612	
15	38330-0515	38330-1915	38330-2615	
18	38330-0518	38330-1918	38330-2618	
21	38330-0521	38330-1921	38330-2621	
24	38330-0524	38330-1924	38330-2624	
27	38330-0527	38330-1927	38330-2627	
30	38330-0530	38330-1930	38330-2630	
33	38330-0533	38330-1933	38330-2633	

Note: Solder Eye is the standard contact tail for plugs and sockets. Contact Molex for additional contact options and order numbers.

Beau™ Power Connectors Panel Mount Plugs and Sockets

38330

Shallow Bracket



Features and Benefits

- Robust blade contacts resist damage from improper mating
- Large surface area of dual wipe female contact produces maximum current capacity
- All circuits are rated for full current load

Reference Information

Packaging: Tray
UL File No.: E34763
CSA File No.: 22156
Designed In: Inches

Electrical

Voltage: 250V
Current: 10.0A

Mechanical

Durability: 500 cycles

Physical

Housing: Phenolic
Plug Contact: Brass
Socket Contact: Phosphor Bronze
Plating: Plug Contact—Tin
Socket Contact—Tin
Operating Temperature: 150°C

Plugs

Circuits	Order No.	Lead-free
15	38330-6415	Yes
18	38330-6418	
21	38330-6421	
24	38330-6424	
27	38330-6427	
30	38330-6430	
33	38330-6433	

Sockets

Circuits	Order No.	Lead-free
15	38330-6815	Yes
18	38330-6818	
21	38330-6821	
24	38330-6824	
27	38330-6827	
30	38330-6830	
33	38330-6833	

Note: Solder Eye is the standard contact tail for plugs and sockets. Contact Molex for additional contact options and order numbers.

Beau™ Power Connectors Panel Mount Plugs and Sockets

38330 Deep Bracket



Plugs

Circuits	Order No.	Lead-free
2	38330-5702	Yes
3	38330-5703	
4	38330-5704	
6	38330-5706	
8	38330-5708	
12	38330-5712	
15	38330-5715	
18	38330-5718	
21	38330-5721	
24	38330-5724	
27	38330-5727	
30	38330-5730	
33	38330-5733	

Note: Solder Eye is the standard contact tail for plugs and sockets. Contact Molex for additional contact options and order numbers.

Features and Benefits

- Robust blade contacts resist damage from improper mating
- Large surface area of dual wipe female contact produces maximum current capacity
- All circuits are rated for full current load

Reference Information

Packaging: Tray
UL File No.: E34763
CSA File No.: 22156
Designed In: Inches

Electrical

Voltage: 250V
Current: 10.0A

Mechanical

Durability: 500 cycles

Physical

Housing: Phenolic
Plug Contact: Brass
Socket Contact: Phosphor Bronze
Plating: Plug Contact—Tin
Socket Contact—Tin
Operating Temperature: 150°C

Sockets

Circuits	Order No.	Lead-free
2	38330-6102	Yes
3	38330-6103	
4	38330-6104	
6	38330-6106	
8	38330-6108	
12	38330-6112	
15	38330-6115	
18	38330-6118	
21	38330-6121	
24	38330-6124	
27	38330-6127	
30	38330-6130	
33	38330-6133	

Beau™ Power Connectors Cable Mount Plugs and Sockets

38331 Cable Clamp Top Cable Clamp Top with Keeper Cable Clamp Top with Latch



Cable Clamp Top shown

Plugs

Circuits	Order No.			Lead-free
	Cable Clamp Top	Cable Clamp Top with Keeper	Cable Clamp Top with Latch	
2	38331-5602	38331-6002	38331-5802	Yes
3	38331-5603	38331-6003	38331-5803	
4	38331-5604	38331-6004	38331-5804	
6	38331-5606	38331-6006	38331-5806	
8	38331-5608	38331-6008	38331-5808	
10	38331-5610	38331-6010	38331-5810	
12	38331-5612	38331-6012	38331-5812	
15	38331-5615	38331-6015	38331-5815	
18	38331-5618	38331-6018	38331-5818	
21	38331-5621	38331-6021	38331-5821	
24	38331-5624	38331-6024	38331-5824	
27	38331-5627	38331-6027	38331-5827	
30	38331-5630	38331-6030	38331-5830	
33	38331-5633	38331-6033	38331-5833	

Note: Solder Eye is the standard contact tail for plugs and sockets. Contact Molex for additional contact options and order numbers.

Features and Benefits

- Latch and keeper hardware ensure that plug and socket remain mated even in high vibration applications
- Robust blade contacts resist damage from improper mating
- Large surface area of dual wipe female contact produces maximum current capacity
- All circuits are rated for full current load

Reference Information

Packaging: Tray
UL File No.: E34763
CSA File No.: 22156
Designed In: Inches

Electrical

Voltage: 250V
Current: 10.0A

Mechanical

Durability: 500 cycles

Physical

Housing: Phenolic
Plug Contact: Brass
Socket Contact: Phosphor Bronze
Plating: Plug Contact—Tin
Socket Contact—Tin
Operating Temperature: 110°C

Sockets

Circuits	Order No.			Lead-free
	Cable Clamp Top	Cable Clamp Top with Keeper	Cable Clamp Top with Latch	
2	38331-8002	38331-8402	38331-8202	Yes
3	38331-8003	38331-8403	38331-8203	
4	38331-8004	38331-8404	38331-8204	
6	38331-8006	38331-8406	38331-8206	
8	38331-8008	38331-8408	38331-8208	
10	38331-8010	38331-8410	38331-8210	
12	38331-8012	38331-8412	38331-8212	
15	38331-8015	38331-8415	38331-8215	
18	38331-8018	38331-8418	38331-8218	
21	38331-8021	38331-8421	38331-8221	
24	38331-8024	38331-8424	38331-8224	
27	38331-8027	38331-8427	38331-8227	
30	38331-8030	38331-8430	38331-8230	
33	38331-8033	38331-8433	38331-8233	

Beau™ Power Connectors Cable Mount Plugs and Sockets

38331 Cable Clamp End



Features and Benefits

- Strain relief cable clamps can be used with round or flat cable
- Robust blade contacts resist damage from improper mating
- Large surface area of dual wipe female contact produces maximum current capacity
- All circuits are rated for full current load

Reference Information

Packaging: Tray
UL File No.: E34763
CSA File No.: 22156
Designed In: Inches

Electrical

Voltage: 250V
Current: 10.0A

Mechanical

Durability: 500 cycles

Physical

Housing: Phenolic
Plug Contact: Brass
Socket Contact: Phosphor Bronze
Plating: Plug Contact—Tin
Socket Contact—Tin
Operating Temperature: 110°C

Plugs

Circuits	Order No.	Lead-free
3	38331-1403	Yes
4	38331-1404	
6	38331-1406	
8	38331-1408	
10	38331-1410	
12	38331-1412	
15	38331-1415	
18	38331-1418	
21	38331-1421	
24	38331-1424	
27	38331-1427	
30	38331-1430	
33	38331-1433	

Sockets

Circuits	Order No.	Lead-free
3	38331-3803	Yes
4	38331-3804	
6	38331-3806	
8	38331-3808	
10	38331-3810	
12	38331-3812	
15	38331-3815	
18	38331-3818	
21	38331-3821	
24	38331-3824	
27	38331-3827	
30	38331-3830	
33	38331-3833	

Note: Solder Eye is the standard contact tail for plugs and sockets. Contact Molex for additional contact options and order numbers.

Beau™ Power Connectors Cable Mount Plugs and Sockets

38330/38331 Flared Hole Top



Features and Benefits

- Robust blade contacts resist damage from improper mating
- Large surface area of dual wipe female contact produces maximum current capacity
- All circuits are rated for full current load

Reference Information

Packaging: Tray
UL File No.: E34763
CSA File No.: 22156
Designed In: Inches

Electrical

Voltage: 250V
Current: 10.0A

Mechanical

Durability: 500 cycles

Physical

Housing: Phenolic
Plug Contact: Brass
Socket Contact: Phosphor Bronze
Plating: Plug Contact—Tin
Socket Contact—Tin
Operating Temperature: 110°C

Plugs

Circuits	Order No.	Lead-free
2	38330-9902	Yes
3	38330-9903	
4	38330-9904	
6	38330-9906	
8	38330-9908	
10	38330-9910	
12	38330-9912	
15	38330-9915	
18	38330-9918	
21	38330-9921	
24	38330-9924	
27	38330-9927	
30	38330-9930	
33	38330-9933	

Sockets

Circuits	Order No.	Lead-free
3	38331-0803	Yes
4	38331-0804	
6	38331-0806	
8	38331-0808	
10	38331-0810	
12	38331-0812	
15	38331-0815	
18	38331-0818	
21	38331-0821	
24	38331-0824	
27	38331-0827	
30	38331-0830	
33	38331-0833	

Note: Solder Eye is the standard contact tail for plugs and sockets. Contact Molex for additional contact options and order numbers.

Beau™ Power Connectors Cable Mount Plugs and Sockets

38330 Flared Hole End



Features and Benefits

- Robust blade contacts resist damage from improper mating
- Large surface area of dual wipe female contact produces maximum current capacity
- All circuits are rated for full current load

Reference Information

Packaging: Tray
UL File No.: E34763
CSA File No.: 22156
Designed In: Inches

Electrical

Voltage: 250V
Current: 10.0A

Mechanical

Durability: 500 cycles

Physical

Housing: Phenolic
Plug Contact: Brass
Socket Contact: Phosphor Bronze
Plating: Plug Contact—Tin
Socket Contact—Tin
Operating Temperature: 110°C

Plugs

Circuits	Order No.	Lead-free
3	38330-8503	Yes
4	38330-8504	
6	38330-8506	
8	38330-8508	
10	38330-8510	
12	38330-8512	
15	38330-8515	
18	38330-8518	
21	38330-8521	
24	38330-8524	
27	38330-8527	
30	38330-8530	
33	38330-8533	

Sockets

Circuits	Order No.	Lead-free
4	38330-9303	Yes
6	38330-9304	
8	38330-9306	
10	38330-9308	
12	38330-9310	
15	38330-9312	
18	38330-9315	
21	38330-9318	
24	38330-9321	
27	38330-9324	
30	38330-9327	
33	38330-9330	

Note: Solder Eye is the standard contact tail for plugs and sockets. Contact Molex for additional contact options and order numbers.

Beau™ Power Connectors Panel Mount Plugs and Sockets

38540 Angle Bracket, Angle Bracket Tapped, Without Angle Bracket



Angle Bracket shown

Features and Benefits

- Robust blade contacts resist damage from improper mating
- Large surface area of dual wipe female contact produces maximum current capacity
- All circuits are rated for full current load

Reference Information

Packaging: Tray
UL File No.: E34763
CSA File No.: 22156
Designed In: Inches

Electrical

Voltage: 250V
Current: 15.0A

Mechanical

Durability: 500 cycles

Physical

Housing: Phenolic
Plug Contact: Brass
Socket Contact: Phosphor Bronze
Plating: Plug Contact—Tin
Socket Contact—Tin
Operating Temperature: 150°C

Plugs

Circuits	Order No.			Lead-free
	Angle Bracket	Angle Bracket Tapped	Without Angle Bracket	
4	38540-0104	38540-1004	38540-1904	Yes
5	38540-0105	38540-1005	38540-1905	
6	38540-0106	38540-1006	38540-1906	
7	38540-0107	38540-1007	38540-1907	
8	38540-0108	38540-1008	38540-1908	
9	38540-0109	38540-1009	38540-1909	
10	38540-0110	38540-1010	38540-1910	
11	38540-0111	38540-1011	38540-1911	
12	38540-0112	38540-1012	38540-1912	
13	38540-0113	38540-1013	38540-1913	
14	38540-0114	38540-1014	38540-1914	
15	38540-0115	38540-1015	38540-1915	
16	38540-0116	38540-1016	38540-1916	

Sockets

Circuits	Order No.			Lead-free
	Angle Bracket	Angle Bracket Tapped	Without Angle Bracket	
4	38540-0604	38540-1504	38540-2404	Yes
5	38540-0605	38540-1505	38540-2405	
6	38540-0606	38540-1506	38540-2406	
7	38540-0607	38540-1507	38540-2407	
8	38540-0608	38540-1508	38540-2408	
9	38540-0609	38540-1509	38540-2409	
10	38540-0610	38540-1510	38540-2410	
11	38540-0611	38540-1511	38540-2411	
12	38540-0612	38540-1512	38540-2412	
13	38540-0613	38540-1513	38540-2413	
14	38540-0614	38540-1514	38540-2414	
15	38540-0615	38540-1515	38540-2415	
16	38540-0616	38540-1516	38540-2416	

Note: Solder Hook is the standard contact tail for plugs. Contact Molex for additional contact options and order numbers.

Note: Solder Eye is the standard contact tail for sockets. Contact Molex for additional contact options and order numbers.

Beau™ Power Connectors Panel Mount Plugs and Sockets

38542 Shallow Bracket



Features and Benefits

- Robust blade contacts resist damage from improper mating
- Large surface area of dual wipe female contact produces maximum current capacity
- All circuits are rated for full current load

Reference Information

Packaging: Tray
UL File No.: E34763
CSA File No.: 22156
Designed In: Inches

Electrical

Voltage: 250V
Current: 15.0A

Mechanical

Durability: 500 cycles

Physical

Housing: Phenolic
Plug Contact: Brass
Socket Contact: Phosphor Bronze
Plating: Plug Contact—Tin
Socket Contact—Tin
Operating Temperature: 150°C

Plugs

Circuits	Order No.	Lead-free
4	38542-0804	Yes
5	38542-0805	
6	38542-0806	
7	38542-0807	
8	38542-0808	
9	38542-0809	
10	38542-0810	
11	38542-0811	
12	38542-0812	
13	38542-0813	
14	38542-0814	
15	38542-0815	
16	38542-0816	

Note: Solder Hook is the standard contact tail for plugs. Contact Molex for additional contact options and order numbers.

Sockets

Circuits	Order No.	Lead-free
4	38542-1304	Yes
5	38542-1305	
6	38542-1306	
7	38542-1307	
8	38542-1308	
9	38542-1309	
10	38542-1310	
11	38542-1311	
12	38542-1312	
13	38542-1313	
14	38542-1314	
15	38542-1315	
16	38542-1316	

Note: Solder Eye is the standard contact tail for sockets. Contact Molex for additional contact options and order numbers.

Beau™ Power Connectors Panel Mount Plugs and Sockets

38540 Deep Bracket



Features and Benefits

- Robust blade contacts resist damage from improper mating
- Large surface area of dual wipe female contact produces maximum current capacity
- All circuits are rated for full current load

Reference Information

Packaging: Tray
UL File No.: E34763
CSA File No.: 22156
Designed In: Inches

Electrical

Voltage: 250V
Current: 15.0A

Mechanical

Durability: 500 cycles

Physical

Housing: Phenolic
Plug Contact: Brass
Socket Contact: Phosphor Bronze
Plating: Plug Contact—Tin
Socket Contact—Tin
Operating Temperature: 150°C

Plugs

Circuits	Order No.	Lead-free
4	38540-3704	Yes
5	38540-3705	
6	38540-3706	
7	38540-3707	
8	38540-3708	
9	38540-3709	
10	38540-3710	
11	38540-3711	
12	38540-3712	
13	38540-3713	
14	38540-3714	
15	38540-3715	
16	38540-3716	

Note: Solder Hook is the standard contact tail for plugs. Contact Molex for additional contact options and order numbers.

Sockets

Circuits	Order No.	Lead-free
4	38540-4204	Yes
5	38540-4205	
6	38540-4206	
7	38540-4207	
8	38540-4208	
9	38540-4209	
10	38540-4210	
11	38540-4211	
12	38540-4212	
13	38540-4213	
14	38540-4214	
15	38540-4215	
16	38540-4216	

Note: Solder Eye is the standard contact tail for sockets. Contact Molex for additional contact options and order numbers.

Beau™ Power Connectors Cable Mount Plugs and Sockets

38541

Cable Clamp Top Cable Clamp Top with Keeper Cable Clamp Top with Latch



Cable Clamp Top shown

Features and Benefits

- Strain relief cable clamps can be used with round or flat cable
- Robust blade contacts resist damage from improper mating
- Large surface area of dual wipe female contact produces maximum current capacity
- All circuits are rated for full current load

Reference Information

Packaging: Tray
UL File No.: E34763
CSA File No.: 22156
Designed In: Inches

Electrical

Voltage: 250V
Current: 15.0A

Mechanical

Durability: 500 cycles

Physical

Housing: Phenolic
Plug Contact: Brass
Socket Contact: Phosphor Bronze
Plating: Plug Contact—Tin
Socket Contact—Tin
Operating Temperature: 110°C

Plugs

Circuits	Order No.			Lead-free
	Cable Clamp Top	Cable Clamp Top with Keeper	Cable Clamp Top with Latch	
4	38541-5404	38541-5804	38541-5604	Yes
5	38541-5405	38541-5805	38541-5605	
6	38541-5406	38541-5806	38541-5606	
7	38541-5407	38541-5807	38541-5607	
8	38541-5408	38541-5808	38541-5608	
9	38541-5409	38541-5809	38541-5609	
10	38541-5410	38541-5810	38541-5610	
11	38541-5411	38541-5811	38541-5611	
12	38541-5412	38541-5812	38541-5612	
13	38541-5413	38541-5813	38541-5613	
14	38541-5414	38541-5814	38541-5614	
15	38541-5415	38541-5815	38541-5615	
16	38541-5416	38541-5816	38541-5616	

Note: Solder Hook is the standard contact tail for plugs. Contact Molex for additional contact options and order numbers.

Sockets

Circuits	Order No.			Lead-free
	Cable Clamp Top	Cable Clamp Top with Keeper	Cable Clamp Top with Latch	
4	38541-8404	38541-8804	38541-8604	Yes
5	38541-8405	38541-8805	38541-8605	
6	38541-8406	38541-8806	38541-8606	
7	38541-8407	38541-8807	38541-8607	
8	38541-8408	38541-8808	38541-8608	
9	38541-8409	38541-8809	38541-8609	
10	38541-8410	38541-8810	38541-8610	
11	38541-8411	38541-8811	38541-8611	
12	38541-8412	38541-8812	38541-8612	
13	38541-8413	38541-8813	38541-8613	
14	38541-8414	38541-8814	38541-8614	
15	38541-8415	38541-8815	38541-8615	
16	38541-8416	38541-8816	38541-8616	

Note: Solder Eye is the standard contact tail for sockets. Contact Molex for additional contact options and order numbers.

Beau™ Power Connectors Cable Mount Plugs and Sockets

38541

Cable Clamp End



Features and Benefits

- Strain relief cable clamps can be used with round or flat cable
- Robust blade contacts resist damage from improper mating
- Large surface area of dual wipe female contact produces maximum current capacity
- All circuits are rated for full current load

Reference Information

Packaging: Tray
UL File No.: E34763
CSA File No.: 22156
Designed In: Inches

Electrical

Voltage: 250V
Current: 15.0A

Mechanical

Durability: 500 cycles

Physical

Housing: Phenolic
Plug Contact: Brass
Socket Contact: Phosphor Bronze
Plating: Plug Contact—Tin
Socket Contact—Tin
Operating Temperature: 110°C

Plugs

Circuits	Order No.	Lead-free
4	38541-0004	Yes
5	38541-0005	
6	38541-0006	
7	38541-0007	
8	38541-0008	
9	38541-0009	
10	38541-0010	
11	38541-0011	
12	38541-0012	
13	38541-0013	
14	38541-0014	
15	38541-0015	
16	38541-0016	

Note: Solder Hook is the standard contact tail for plugs. Contact Molex for additional contact options and order numbers.

Sockets

Circuits	Order No.	Lead-free
4	38541-3004	Yes
5	38541-3005	
6	38541-3006	
7	38541-3007	
8	38541-3008	
9	38541-3009	
10	38541-3010	
11	38541-3011	
12	38541-3012	
13	38541-3013	
14	38541-3014	
15	38541-3015	
16	38541-3016	

Note: Solder Eye is the standard contact tail for sockets. Contact Molex for additional contact options and order numbers.

Beau™ Power Connectors Cable Mount Plugs and Sockets

38540 Flared Hole Top



Features and Benefits

- Robust blade contacts resist damage from improper mating
- Large surface area of dual wipe female contact produces maximum current capacity
- All circuits are rated for full current load

Reference Information

Packaging: Tray
UL File No.: E34763
CSA File No.: 22156
Designed In: Inches

Electrical

Voltage: 250V
Current: 15.0A

Mechanical

Durability: 500 cycles

Physical

Housing: Phenolic
Plug Contact: Brass
Socket Contact: Phosphor Bronze
Plating: Plug Contact—Tin
Socket Contact—Tin
Operating Temperature: 110°C

Plugs

Circuits	Order No.	Lead-free
4	38540-8204	Yes
5	38540-8205	
6	38540-8206	
7	38540-8207	
8	38540-8208	
9	38540-8209	
10	38540-8210	
11	38540-8211	
12	38540-8212	
13	38540-8213	
14	38540-8214	
15	38540-8215	
16	38540-8216	

Note: Solder Hook is the standard contact tail for plugs. Contact Molex for additional contact options and order numbers.

Sockets

Circuits	Order No.	Lead-free
4	38540-9204	Yes
5	38540-9205	
6	38540-9206	
7	38540-9207	
8	38540-9208	
9	38540-9209	
10	38540-9210	
11	38540-9211	
12	38540-9212	
13	38540-9213	
14	38540-9214	
15	38540-9215	
16	38540-9216	

Note: Solder Eye is the standard contact tail for sockets. Contact Molex for additional contact options and order numbers.

Beau™ Power Connectors Cable Mount Plugs and Sockets

38540 Flared Hole End

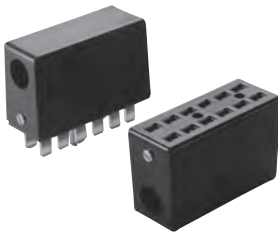

Features and Benefits

- Robust blade contacts resist damage from improper mating
- Large surface area of dual wipe female contact produces maximum current capacity
- All circuits are rated for full current load

Reference Information

Packaging: Tray
UL File No.: E34763
CSA File No.: 22156
Designed In: Inches

Electrical

Voltage: 250V
Current: 15.0A

Mechanical

Durability: 500 cycles

Physical

Housing: Phenolic
Plug Contact: Brass
Socket Contact: Phosphor Bronze
Plating: Plug Contact—Tin
Socket Contact—Tin
Operating Temperature: 110°C

Plugs

Circuits	Order No.	Lead-free
4	38540-6404	Yes
5	38540-6405	
6	38540-6406	
7	38540-6407	
8	38540-6408	
9	38540-6409	
10	38540-6410	
11	38540-6411	
12	38540-6412	
13	38540-6413	
14	38540-6414	
15	38540-6415	
16	38540-6416	

Note: Solder Hook is the standard contact tail for plugs. Contact Molex for additional contact options and order numbers.

Sockets

Circuits	Order No.	Lead-free
4	38540-7404	Yes
5	38540-7405	
6	38540-7406	
7	38540-7407	
8	38540-7408	
9	38540-7409	
10	38540-7410	
11	38540-7411	
12	38540-7412	
13	38540-7413	
14	38540-7414	
15	38540-7415	
16	38540-7416	

Note: Solder Eye is the standard contact tail for sockets. Contact Molex for additional contact options and order numbers.

Contact Information

Contact Information

Americas Offices.....	I-2 to I-3
Molex Global Locations	I-5 to I-8
Global Franchised Distributor Network.....	I-10 to I-24

Americas Offices

Corporate Headquarters

2222 Wellington Court
Lisle, IL 60532
Phone: 630-969-4550
Fax: 630-969-1352

Northwest Region

Regional Office
920 Hillview Court
Suite 200
Milpitas, CA 95035
Phone: 408-946-4700
Fax: 408-946-5386

District Office
4000 SW Kruse Way Place
Building #1, Suite 220
Lake Oswego, OR 97035
Phone: 503-697-3193

Midwest Region

Regional Office
2222 Wellington Court
Lisle, IL 60532
Phone: 630-969-4747
Fax: 630-512-8622

District Office
4620 West 77th
Suite 280
Edina, MN 55435
Phone: 952-893-9029
Fax: 952-837-9955

Northeast Region

Regional Office
600 West Cummings Park
Suite 6900
Woburn, MA 01801
Phone: 781-935-8983
Fax: 781-932-3857

Canada Office
Markham, Ontario,
Canada L3R 0E7
Phone: 905-944-1415
Fax: 905-944-1422

Southwest Region

Regional Office
9111 Jollyville Road
Suite 105
Austin, TX 78759
Phone: 512-345-1092
Fax: 512-345-9805

District Office
23461 South Pointe Drive
Suite 385
Laguna Hills, CA 92653
Phone: 949-588-3701
Fax: 949-588-8880

District Office
9948 Hibert Street
Suite 101
San Diego, CA 92131
Phone: 858-537-2400
Fax: 858-537-2408

Automotive Region

Regional Office
2025 Taylor Road
Auburn Hills, MI 48326
Phone: 248-371-9700
Fax: 248-371-9817

District Office
729 E. Main
Westfield, IN 46074
Phone: 317-896-6539
Fax: 317-896-3816

Southeast Region

Regional Office
6525 The Corners Parkway
Suite 206
Norcross, GA 30092
Phone: 770-840-0800
Fax: 770-840-9991

District Office
430 Davis Drive
Suite 120
Morrisville, NC 27560 (Mail)
Durham, NC 27713 (Deliveries)
Phone: 919-991-1199
Fax: 919-991-1533

Americas Offices

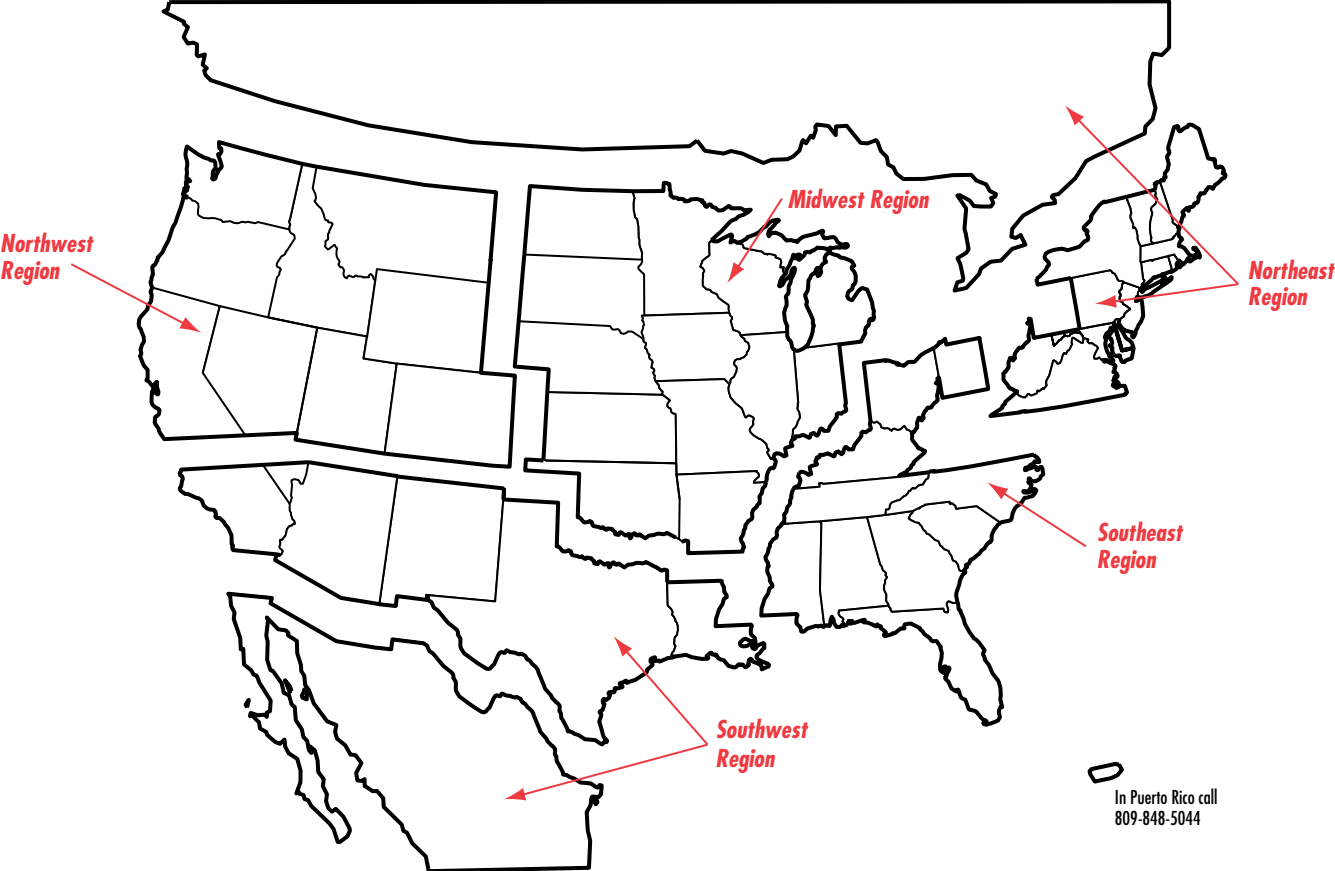

Molex Global Locations

Headquarters

Corporate and Americas Headquarters

2222 Wellington Court
Lisle, IL 60532 USA
Tel: 630-969-4550
Fax: 630-969-1352

European Headquarters

Molex Holding GmbH
Dingolfinger Strasse 4
81673 Munich, Germany
Tel: 49-89-413092-0
Fax: 49-89-401527

Asia Pacific North Headquarters

Molex Japan Co. Ltd.
1-5-4 Fukami-Higashi
Yamato-City, Kanagawa
242-8585 Japan
Tel: 81-46-265-2336
Fax: 81-46-265-2361

Asia Pacific South Headquarters

Molex Far East South Management Pte Ltd.
No. 110, International Road
Jurong 629174, Singapore
Tel: 65-6268-6868
Fax: 65-6265-6044

Molex Subsidiary and Rep List

Australia

Molex ANZ.

(Australia & New Zealand)
C/- 60-78 Abey Road
Melton, Victoria 3337
Australia
Tel: 61-2-9755-4428
Fax: 61-2-9755-4428

Molex Premise Networks

60-78 Abey Road
Melton, Victoria 3337
Australia
Tel: 61-3-9971-7111
Fax: 61-3-9971-7199

Austria

Molex Deutschland GmbH (Sales)

2393 Sittendorf 159, Austria
Tel: 43-2237-8163
Fax: 43-2237-81634
E-mail: mxaustralia@molex.com

Brazil

Molex Brasil Ltda.

Rua Capitaó Francisco Teixeira
Nogueira #232 Bairro Agua Branca
CEP 05037-030-Sao Paulo-SP-Brazil
Tel: 55-11-3611-2399
Fax: 55-11-3611-1891
E-mail: brasil@molex.com

Molex Brasil Ltda.

Avenida Cupiuba 476
Distrito Industrial
Manaus, Amazonas Brazil
Tel: 55-92-671-3000
Fax: 55-92-615-2536
E-mail: brasil@molex.com

Canada

Molex Electronics Ltd.

1870 Des Sources Blvd, Suite 302
Pointe Claire, QC
H9R 5N4 Canada
Tel: 514-630-1177
Fax: 514-630-1440
E-mail: canada@molex.com

Molex Electronics Ltd.

85 Select Avenue
Scarborough, Ontario M1V 4A9
Canada
Tel: 416-292-1444
Fax: 416-292-2922
E-mail: canada@molex.com

Czech Republic

Molex Czech

Prikop 6
602 00 Brno, Czech Republic
Tel: 420-5-45176746
Fax: 420-5-45176747
E-mail: mxczech@molex.com

Denmark

Molex G. Ostervig A/S

Paul Bergsoes Vej 16
2600 Glostrup, Denmark
Tel: 45-43-431030
Fax: 45-43-434460
E-mail: mxdenmark@molex.com

Central and Eastern Europe

Molex Deutschland GmbH

Felix-Wankel-Strasse 11
74078 Heilbronn
Tel: 49-7066-9555-0
Fax: 49-7066-9555-8100
E-mail: mxeeurope@molex.com

Egypt

High Technology Systems

Building 43R, Section Six
Zahraa Maadi Main Road,
P.O. Box 50
New Maadi 11742
Cairo, Egypt
Tel: 20-2-7491051
Fax: 20-2-7486278
E-mail: information@highteknofal.com

United Kingdom (England)

Molex UK

Molex House, Millennium Centre
Farnham, Surrey GU9 7XX
England
Tel: 44-1252-720720
Fax: 44-1252-720721
E-mail: mxuk@molex.com

Finland

Äyritie 12 B
01510 Vantaa, Finland
Tel: 358-9-75946610
Fax: 358-9-75946620
E-mail: mxfinland@molex.com

France

Molex France (Sales)

18 Parc Burospace
91571 Bievres Cedex, France
Tel: 33-1-69354900
Fax: 33-1-69410100
E-mail: mxfrance@molex.com

Molex Automotive SARL

25, Parc Burospace
91571 Bièvres cedex, France
Tel: 33-1-64538740
Fax: 33-1-60194978

Molex Automotive SARL

(Automotive Factory)
2 et 4 av. du President Roosevelt
31340 Villemur-sur-Tarn
Tel: 33-5-62220333
Fax: 33-5-61092086



Molex Global Locations

Germany

Molex Deutschland GmbH (Sales)

Felix-Wankel-Strasse 11
74078 Heilbronn-Biberach, Germany
Tel: 49-7066-9555-0
Fax: 49-7066-9555-8100
E-mail: mxgermany@molex.com

Molex Elektronik GmbH (Automotive Factory)

Grashofstrasse 17
76275 Ettlingen, Germany
Tel: 49-7243-3350
Fax: 49-7243-31420

Molex GmbH (Telecom Factory)

Felix-Wankel-Strasse 9
74078 Heilbronn-Biberach, Germany
Tel: 49-7066-30-0
Fax: 49-7066-30-120

Hong Kong

Molex Hong Kong/China Ltd

Unit 1715-23A, Level 17
Landmark North
39 Lung Sum Avenue
Sheung Shui, New Territories
Hong Kong
Tel: 852-2637-3111
Fax: 852-2637-5990

Hungary

Molex Deutschland GmbH (Sales)

Szent I. park 15
1137 Budapest, Hungary
Tel: 36-1-359-9765
Fax: 36-1-288-0537
E-mail: mxhungary@molex.com

India

Molex (India) Ltd.

Plot No. 6 (A)
Sadaramangala Industrial Area
Kadugodi
Bangalore 560 067, India
Tel: 91-80-41293500/01/02/03
Fax: 91-80-41293600/01

Molex Mafatlal Micron Ltd.

C-7 & 8, GIDC Electronic Estate
K-Road, Sector 25
Gandhinagar Gujarat 382 025
Tel: 91-79-23225338
Fax: 91-79-23226906

Ireland

Molex Ireland Ltd. (Factory)

Site 3, Shannon Industrial Est.
Shannon Free Airport
Shannon, Ireland
Tel: 353-61-702400
Fax: 353-61-702700

Molex Ireland (Sales)

62 Pembroke Road
Ballsbridge
Dublin 4, Ireland
Tel: 353-1-6675511
Fax: 353-1-6675512
E-mail: mxireland@molex.com

Molex Millstreet

(Cable Assemblies Factory)
Mount Leader Industrial Est
Millstreet Town
County Cork, Ireland
Tel: 353-29-70252
Fax: 353-29-70648

Italy

Molex Italy

Sede Sec. of Molex BV
(Italian Sales Branch)
Via Roma, 108
Cassina Plaza
20060 Cassina De' Pecchi
Milano, Italy
Tel: 39-02-950551
Fax: 39-02-95055250
E-mail: mxitaly@molex.com

Molex Zetronic SPA (Factory)

Via Nona Strada, 29
35129 Padova, Italy
Tel: 39-049-8072071
Fax: 39-049-8072548

Japan

Molex Japan Co. Ltd.

1-5-4 Fukami-Higashi
Yamato-City, Kanagawa
242-8585 Japan
Tel: 81-46-265-2324
Fax: 81-46-265-2366

Korea

Molex Korea Co. Ltd.

726-3, Wonsi-Dong
Ansan City, Gyunggi-Do
Republic of Korea, 425-090
Tel: 82-31-492-9000
Fax: 82-31-491-4364

Seoul Office, Molex Korea

#303 Shinsong Bldg,
25-4, Yoido-Dong, Youngdungpo-Ku
Seoul, Korea, 150-010
Tel: 82-2-780-2333
Fax: 82-2-780-3989

Malaysia

Molex Malaysia Sdn Bhd

2607 Jalan Perusahaan
Kawasan Perindustrian Prai
13600 Prai, Penang Malaysia
Tel: 60-4-507-8788
Fax: 60-4-507-8140

Molex (Malaysia) Sdn Bhd

73A Jalan USJ21/10
47630 Subang Jaya
Selangor Darul Ehsan
Tel: 603-80239980/81/82
Fax: 603-80231052

Molex Malaysia Sdn. Bhd. (JB)

No. 8A, Jalan Dedap 17
Taman Johor Bahru, Johor,
West Malaysia
Tel: 60-7-356-2371
Fax: 60-7-356-2384

Mexico

Molex De Mexico, S.A. De C.V.

Av. De La Productividad #305
Parque Industrial Guadalajara
Guadalajara, Jalisco, Mexico
Tel: 52-36-68-14-00
Fax: 52-36-68-14-95

Netherlands (Benelux)

Molex BV

Luchthavenweg 38
5657 EB Eindhoven
The Netherlands
Tel: 31-40-2958201
Fax: 31-40-2958206
E-mail: mxnetherlands@molex.com

Molex Interconnect GmbH

(European Distribution Center)
Luchthavenweg 38
5657 EB Eindhoven
The Netherlands
Tel: 31-40-2958295
Fax: 31-40-2958290

Norway

Molex G. Knutsen AS

Brynsveien 16
Postboks 6104 Etterstad
0667 Oslo, Norway
Tel: 47-23-039100
Fax: 47-23-039149
E-mail: mxnorway@molex.com

Molex Global Locations

People's Republic of China

Beijing (Sales)

Room 1311, Tower B, COFCO Plaza
No. 8, Jian Guo Men Nei Street
Beijing 100005
People's Republic of China
Tel: 86-10-6526-9628
Fax: 86-10-6526-9730

Chengdu (Sales)

Room 806A, Tower A World
No. 17, 2nd Section
South of 1st Cycle Way
Chengdu City 610016
People's Republic of China
Tel: 86-28-8548-0463
Fax: 86-28-8548-0461

Dalian (Sales)

12F, Sen Mao Building
147 Zhongshan Road,
Si Gan Area
Dalian 116011
People's Republic of China
Tel: 86-411-8367-7245
Fax: 86-411-8367-7250

Dongguan Plant 1

Molex Interconnect
(Dongguan) Co., Ltd.
C Zone, Ming Hua Road,
No. 3, Industrial Area Juzhou,
Shijie Town, Dongguan City,
Guangdong Province 523298
People's Republic of China
Tel: 86-769-8631-0328
Fax: 86-769-8631-0323

Dongguan Plant 2

Molex Interconnect
(Dongguan) Co., Ltd.
C Zone, Ming Hua Road,
No. 3, Industrial Area Juzhou,
Shijie Town, Dongguan City,
Guangdong Province 523298
People's Republic of China
Tel: 86-769-8630-2328
Fax: 86-769-8631-0378

Guangzhou (Sales)

Room 1208, GIE Tower
403 Huan Shi East Road, Guangzhou City
People's Republic of China
Tel: 86-20-8732-2407
Fax: 86-20-8732-2482

Molex Interconnect (Shanghai) Co., Ltd.

No. 889, Ying Lun Road
WaiGaoQiao Free Trade Zone
Pudong, Shanghai 200131
People's Republic of China
Tel: 86-21-5048-0889
Fax: 86-21-5048-0011

Molex Premise Networks - Sales

Room 1608, Hongqiao Silver City
No. 933, Zhongshan West Road
Shanghai 200051
People's Republic of China
Tel: 86-21-5111-3418
Fax: 86-21-5111-3419

Nanjing (Sales)

Room C5C6, 22 Floor
Shang Mao Century Plaza
No. 49 Zhongshan South Road
Nanjing 210005
People's Republic of China
Tel: 86-25-8689-0051
Fax: 86-25-8689-0056

Qingdao (Sales)

Room 1315, Crowne Plaza
No. 76, Xiang Gang Zhong Road
Qingdao 266071
People's Republic of China
Tel: 86-532-8576-6175
Fax: 86-532-8576-4999

Shenzhen (Sales)

3/F Union Cyber Building
No. 1 Huanghuai Road
Futian Free Trade Zone
Shenzhen, 518038
People's Republic of China
Tel: 86-755-2518-5819
Fax: 86-755-2518-5810

Suzhou (Sales)

Room 901,
Century Financial Tower,
No. 1 Suhua Road
Suzhou Industrial Park, Suzhou
Jiangsu 215021
People's Republic of China
Tel: 86-512-6761-5521
Fax: 86-512-6761-4610

Tianjin (Sales)

Room 2401, International Building,
No. 75 Nanjing Road,
Heping District,
Tianjin 300050
People's Republic of China
Tel: 86-22-2332-1717
Fax: 86-22-2311-9629

Xiamen (Sales)

Unit 11, 18/F The Bank Center,
No. 189 XiaHe Road, Xiamen
Fujian 361003
People's Republic of China
Tel: 86-592-239-9515
Fax: 86-592-239-9519

Philippines

Molex Far East

South Management Pte Ltd
Unit 1007 South Center Tower
2206 Market St.
Madrigal Business Park
Alabang, Muntinlupa City,
Metro Manila
Philippines
Tel: 632-7724608/4610/4612
Fax: 632-7724611

Poland

Molex Polska Sp zo.o.

(Polish Sales Branch)
Zytunia 15/13
01-014 Warsaw, Poland
Tel: 48-22-8621481
Fax: 48-22-8623143
E mail: mxpolska@molex.com

Moltech Polska Sp zo.o. (Factory)

ul. Poznanska 23
69 200 Sulecin, Poland
Tel: 48-95-7560-100
Fax: 48-95-7560-186

Romania

Molex Deutschland GmbH

Gabriel Sajter
str. Timis, nr. 9, sc.C., ap.19
300650 Timisoara, Romania
Tel: 40-356809118
Fax: 40-356809118
E-mail: gabriel.sajter@molex.com

Russia/Ukraine/Azerbaijan, Baltic Countries, Belarus, Moldavia

Molex Russia

Commercial Tower "Meridian"
Smolnaya Street 24/D, 7th Floor
125445 Moscow, Russia
Tel: 7-495-2588444
Fax: 7-495-2588444
E-Mail: mxrussia@molex.com

Serbia/Bulgaria, Croatia, Macedonia, Montenegro, Slovenia

Zoran Rabrenovic

Danice Markovic 2
11000 Belgrade, Serbia
Tel: 381-11-3046124
Fax: 381-11-3046124
Email: mxserbia@molex.com



Molex Global Locations

Singapore

Molex Singapore Pte. Ltd.
No. 110, International Road
Singapore 629174
Tel: 62-6268-6868
Fax: 65-6264-2745

Slovak Republic

Molex Slovakia, a.s. (Factory)
Kechnec 265
044 58 Kechnec
Slovak Republic
Tel: 421-55-7273111
Fax: 421-55-7273100

South Africa

Molex (Pty.) Ltd.
Cnr. Gazelle Avenue and
Lechwe Street
Corporate Park, Halfway House
Midrand, South Africa 1685
Tel: 27-11-3144700
Fax: 27-11-3144681
E-mail: mxsafrika@molex.com

Spain

Molex Spain
Valencia, 307, 1-3
08009 Barcelona, Spain
Tel: 34-93-4766880
Fax: 34-93-4766881
E-mail: mxspain@molex.com

Sweden

Molex Sweden
Travgatan 88 Box 2007
194 27 Upplands Väsby, Sweden
Tel: 46-8-59421100
Fax: 46-8-59421120
E-mail: mxsweden@molex.com

Taiwan

Molex Taiwan Ltd.
100-3 Shia-Kwei-Rou-Shan
Tamshui, Taipei Hsien Taiwan
Republic of China
Tel: 886-2-2620-2300
Fax: 886-2-2622-3124

Thailand

Molex (Thailand) Co. Ltd.
No. 71/4 Moo 5 Bangpakong Ind. Pk
Bangna-Trad Road, KM52,
Tambol Takarm
Bangpakong, Chachoengsao 24130
Thailand
Tel: 66-38-573020
Fax: 66-38-573023

Turkey, Greece and Middle East

Molex Turkiye
Edin & Suner Plaza
Meydan Sok No. 14 Kat: 6B
Akattlar, 34335
Istanbul, Turkey
Tel: 90-212-351-0930
Fax: 90-212-351-09 25
E-mail: mxturkey@molex.com

Global Franchised Distributor Network

North America

Canada

Alberta

Calgary

Arrow Electronics Components

Unit D, 2151-32 Street N.E.
Calgary, AB T1Y 7G3
Tel: 403-735-2800
Fax: 403-259-8699
Toll-free: 800-833-3557
E-mail: feedback@arrow.com

Avnet Electronics Marketing

112, 2635 37th Ave N.E.
Calgary, AB T1Y 5Z6
Tel: 403-291-5510
Fax: 403-291-5696
Toll-free: 800-408-8353
E-mail: customer.care@avnet.com

Edmonton Arrow Electronics Components

10630 172 Street
Edmonton, AB T5S 1H8
Tel: 780-483-6266
Fax: 780-484-8926
Toll-free: 800-833-3557
E-mail: feedback@arrow.com

Redmond, WA

TTI, Inc.
11121 Willows Road NE, Suite 130
Redmond, WA 98052
Tel: 425-882-0291
Fax: 425-883-3776
Toll-free: 800-225-5884

British Columbia

Vancouver

Avnet Electronics Marketing

8610 Commerce Court
Burnaby, B.C. V5A 4N6
Tel: 604-420-4101
Fax: 604-420-5376
Toll-free: 800-408-8353
E-mail: customer.care@avnet.com

Arrow Electronics Components

8521 Commerce Court
Burnaby, B.C. V5A 4N3
Tel: 604-421-2333
Fax: 604-421-5030
Toll-free: 800-833-3557
E-mail: feedback@arrow.com

Redmond, WA

TTI, Inc.
11121 Willows Road NE, Suite 130
Redmond, WA 98052
Tel: 425-882-0291
Fax: 425-883-3776
Toll-free: 800-225-5884

Saskatchewan

Redmond, WA

TTI, Inc.
11121 Willows Road NE, Suite 130
Redmond, WA 98052
Tel: 425-882-0291
Fax: 425-883-3776
Toll-free: 800-225-5884

Nova Scotia

Halifax

Arrow Advantage Canada

155 Chain Lake Drive, Suite 27
Halifax, N.S. B3S 1B3
Tel: 800-833-3557
Fax: 902-450-2657
Toll-free: 800-833-3557
E-mail: feedback@arrow.com

Ontario

London

Simcona Electronics of Canada

3422 Wonderland Road,
London, ON N6L 1A7
Tel: 519-652-1130
Fax: 519-652-1131
Toll-free: 800-567-3815
E-mail: info@simcona.ca

Newark InOne

331 Consortium Court
London, ON N6E 2S8
Tel: 519-685-4280
Fax: 519-685-7104
Toll-free: 800-463-9275
E-mail: london@newarkinone.com

Ottawa

Arrow Electronics Components

84 Hines Road, Suite 100
Kanata, ON K2K 3G3
Tel: 613-287-3211
Fax: 613-287-3250
Toll-free: 800-833-3557
E-mail: feedback@arrow.com

Avnet Electronics Marketing

190 Colonnade Rd
Kanata, ON K2E 7J5
Tel: 613-226-1700
Fax: 613-226-1184
Toll-free: 800-408-8353
E-mail: customer.care@avnet.com

Toronto

Arrow Electronics Components

171 Superior Boulevard
Mississauga, ON L5T 2L6
Tel: 905-565-4405
Fax: 905-837-3938
Toll-free: 800-833-3557
E-mail: feedback@arrow.com

Avnet Electronics Marketing

6705 Millcreek Drive
Mississauga, ON L5N 5R9
Tel: 905-812-4400
Fax: 905-812-4459
Toll-free: 800-408-8353
E-mail: customer.care@avnet.com

* Gould Fasteners Ltd.

6209 Northwest Drive
Mississauga, ON L4V 1P6
Tel: 905-677-8253
Fax: 905-677-8767
Toll-free: 800-267-8997
E-mail: email@gouldfast.ca

Heilind Electronics

275 Renfrew Drive, Suite 102
Markham, ON L3R 0C8
Tel: 905-752-1270
Fax: 905-752-1273
Toll-free: 866-290-9280
E-mail: cansales@heilind.com

Newark InOne

6375 Dixie Road, Suite 202
Mississauga, ON L5T 2E7
Tel: 905-670-2888
Fax: 905-670-1019
Toll-free: 800-463-9275
E-mail: toronto@newarkinone.com

Sager Electronics

151 Superior Blvd, Suite 22
Mississauga, ON L5T 2L1
Tel: 905-677-6124
Fax: 905-677-6127
Toll-free: 800-724-3780
E-mail: sagerinfo@sager.com

Simcona Electronics of Canada

989 Derry Road East, Suite 403
Mississauga, ON L5T 2J8
Tel: 800-567-3815
Fax: 519-652-1131
E-mail: info@simcona.ca

TTI Electronics

690 Rowntree Dairy Road
Woodbridge, ON L4L 5T7
Tel: 905-850-3003
Fax: 905-850-4442
Toll-free: 800-225-5884
E-mail: information@ttiinc.com

* Wes-Garde Components Group, Inc.

6740 Davand Drive, #2
Mississauga, ON L5T 2K9
Tel: 905-670-3100
Fax: 905-670-3107
Toll-free: 800-275-7090
E-mail: onsales@wesgarde.com

Quebec

Montreal

Arrow Electronics Components

19180 Trans-Canada Highway
Baie d'Urfe, QC H9X 3S4
Tel: 514-428-5250
Fax: 514-428-1652
Toll-free: 800-833-3557
E-mail: feedback@arrow.com

Avnet Electronics Marketing

7575 Route Transcanadienne, Ste 600
St-Laurent, QC H4T 1V6
Tel: 514-335-1000
Fax: 514-335-2481
Toll-free: 800-408-8353
E-mail: customer.care@avnet.com

*Authorized Molex Industrial Distributor

Global Franchised Distributor Network

North America

Canada (cont)

Newark InOne
1870 Sources Blvd, Suite 300
Pointe-Claire, QC H9R 5N4
Tel: 514-426-6336
Fax: 514-426-6327
Toll-free: 800-463-9275
E-mail: montreal@newarkinone.com

Simcona Electronics of Canada
278 Labrosse
Pointe-Claire, QC H9R 5L8
Tel: 514-693-1771
Fax: 514-693-1605
Toll-free: 800-565-2811
E-mail: montreal-info@simcona.ca

TTI Electronics
1868 Sources Blvd, Suite 318
Pointe-Claire, QC H9R 5R5
Tel: 514-426-1212
Fax: 514-426-1409
Toll-free: 800-225-5884
E-mail: information@ttiinc.com

United States

Nationally Franchised Distributors

Arrow
Tel: 800-833-3557
E-mail: molexsupport@arrow.com

Avnet Electronics Marketing
Tel: 800-408-8353
E-mail: avnet_em_webmaster@ims.avnet.com

Force Electronics
Tel: 877-588-9071
E-mail: email@force-elec.com

Heilind Electronics
Tel: 877-588-9071
E-mail: contact@heilind.com

Sager Electronics
Tel: 800-SAGER-800
800-724-3780
E-mail: sagerinfo@sager.com

TTI
Tel: 800-CALL-TTI
800-225-5884
E-mail: quotes@ttiinc.com

Locally Franchised Distributors

Carlton Bates
Tel: 866-600-6040
E-mail: cbsales@carlton-bates.com

NEP
Tel: 800-284-7470
E-mail: ilsales@nepelectronics.com

Radar
Tel: 800-282-2524
E-mail: natej@radarinc.com

Sub-Sem
Tel: 800-435-6130
E-mail: sales@subsem.com

Catalog Distributors

Mouser
Tel: 800-346-6873
E-mail: sales@mouser.com

Newark
Tel: 800-4-NEWARK
800-463-9275

Catalog Distributors (via Waldom)

Allied
Tel: 800-433-5700

Digi-Key
Tel: 800-344-4539

Fiber Optics Distributors

FIS
Tel: 800-500-0347
E-mail: fis@borg.com

Fiber Optic Center
Tel: 800-473-4237
E-mail: sales@focenter.com

Fiber Solutions
Tel: 800-743-4237
E-mail: info@fibersinc.com

Industrial Products Distributors

Askew Hardware
2920 Supply Avenue
Commerce, CA 90040
Tel: 800-322-7539
E-mail: mbrown@askewhardware.com

Babsco Supply
2410 South Main Street
Elkhart, IN 46515
Tel: 800-654-4849
E-mail: appetit@babsco.com

Beyond Components
5 Carl Thompson Road
Westford, MA 01886
Tel: 800-971-4242
E-mail: sales@beyondc.com

Bisco Industries
1500 North Lakeview Ave.
Anaheim, CA 92807
Tel: 800-323-1232
E-mail: info@biscoind.com

Electrical Accessories
11033 Lin Valle Drive
St. Louis, MO 63123
Tel: 800-878-1515
E-mail: gina@electricalaccessories-stl.com

Electro-Matic Products, Inc
23409 Industrial Park Ct
Farmington Hills, MI 48335
Tel: 248-478-1182
E-mail: ecustomerservice@electro-matic.com

Electronic Industries
19 East Irving Avenue
Oshkosh, WI 54901
Tel: 800-558-0222
E-mail: karll@electronicind.com

Lake-View Electronics
1054 E Pioneer Road
Grafton, WI 53024
Tel: 800-686-8439
E-mail: sales@lvelectronics.com

Madison Electric
3185 Van Dyke
Warren, MI 48093
Tel: 586-825-0150
E-mail: info@madisonelectric.com

Marsh Electronics
1563 South 101st Street
Milwaukee, WI 53214
Tel: 414-475-6000
E-mail: sales@marshelectronics.com

Global Franchised Distributor Network

North America/South America/Europe

United States (cont)

Industrial Products Distributors (cont)

MPAQ Electronics

4850 Wright Road, Suite 150
Stafford, TX 77477

Tel: 866-366-4672

E-mail: info@mpaquelectronics.com

Nedco

1169 Knollwood Circle
Anaheim, CA 92801

Tel: 800-605-2323

E-mail: netsales@nedcoelectronics.com

Nelco

22 Riverside Drive
Pembroke, MA 02359

Tel: 800-346-3526

E-mail: info@nelcoproducts.com

Standard Electric

2650 Trautner Drive
Saginaw, MI 48603

Tel: 989-497-2100

E-mail: info@standardelectricco.com

Standard Electric Supply

222 North Ember Lane
Milwaukee WI 53201

Tel: 800-776-8222

E-mail: mfelker@sescowi.com

Wes-Garde Components

190 Elliott Street
Hartford, CT 06114

Tel: 800-554-8866

E-mail: sales@wesgarde.com

Winar/Number One Sales

3623 Brecksville Road
Richfield, OH 44286

Tel: 800-237-1947

E-mail: sales@winar.com

STARs Cable Assembly Partners

Arrow Cable Assembly Services
Avnet Physical Value Added Services

Buse Interconnect Products

Cable-Comm Technologies

Maverick Electronics

NEP Electronics

Sub Sem Electronics

South America

Brazil

Avnet do Brasil

R. Luis Gois, 1205 - 2 andar
04043-300 - São Paulo - SP

Tel : 55-11-5079-2150

Fax : 55-11-5079-2160

Email: rose.cetrone@avnet.com

Europe

Austria

Avnet Time

Diefenbachgasse 35/2
A-1150 Wien

Tel: 43-1-8 66-42-300

Fax: 43-1-8-66-42-350

E-mail: TimeAustria@avnet.com

Burisch Elektronik GmbH

Leopoldauer Str. 29
A-1210 Wien

Tel: 43-1-277-200

Fax: 43-1-277-202-77

E-mail: ma@beb.co.at

Farnell InOne

Keltenring 14,
82041 Oberhaching

Germany

Tel: 49-89-61-393939

Fax: 49-89-61-355901

E-mail: sales@farnellinone.com

Rutronik Elektronische

Bauelemente GmbH

Waidhausenstraße 19
Top 10

A-1140 Wien

(with office in Wels)

Tel: 43-1-4-19-65-50-0

Fax: 43-1-4-19-65-50-33

E-mail: rutronik_a@rutronik.com

SPOERLE

A Division of Arrow Central Europe

Landstraßer Hauptstraße 97-101/1/4/A

A-1030 Wien

(with office in Dornbirn)

Tel: 43-1-3-60-46-0

Fax: 43-1-3-60-46-90

E-mail: vertrieb.wien@spoerle.com

TTI Electronics Austria GmbH

Amalienstraße 48

Top 4

A-1130 Wien

Tel: 43-1-8-79-85-90-0

Fax: 43-1-8-79-85-90-10

E-mail: sales.vienna@at.ttiinc.com

Fiber Optics Distributors

0.3 dB la logistique

de la Fibre Optique

27, rue du Général de Gaulle BP 12

95640-Marines-France

Tel: 33-0-1-30-30-92-03

Fax: 33-0-1-30-39-99-03

E-mail: contact@03db.com

Global Franchised Distributor Network

Europe (cont)

Belgium and Luxembourg

AVNET TIME

Kouterveldstraat 20,
1831 Diegem,
Belgium
Tel: 32-27-09-90-00
Fax: 32-27-09-98-01
E-mail: TimeBE@Avnet.com

Farnell InOne

Zonnebaan 33, 3606 CH Maarsen,
Netherlands
Tel: 32-32-27-36-47
Fax: 32-32-27-36-48
E-mail: sales@farnellinone.com

SPOERLE

A Division of Arrow Central Europe
Keiberg II,
Minervastraat 14/B2,
1930 Zaventem, Belgium
Tel: 32-27-25-46-60
Fax: 32-27-25-45-11
E-mail: SalesOffice.Brussels@spoerle.com

TTI Inc.

Office Benelux
ESP 210, 5633 AC Eindhoven
The Netherlands
Tel: 31-40-290-16-16
Fax: 31-40-290-16-10
E-mail: sales.benelux@nl.ttiinc.com

Denmark

Farnell InOne

Marielundvej 48 D, 2730 Helev,
Tel: 45-44-536644
Fax: 45-44-536606
E-mail: sales@farnellinone.com

Molex G Oestervig A/S

Paul Bergsoes Vej 16
2600 Glostrup
Tel: 45-43-431030
Fax: 45-43-434460

Finland

Arrow Finland

Kalkkipellontie 4
FIN-02650 Espoo
P.O.Box 280, FIN-02601 Espoo
Tel: 358-9-476660
Fax: 358-9-47666356
Tiina Weckman:
E-mail: tweckman@arrownordic.com
Direct: 358-9-47666-431

Farnell InOne

Kirkinkylantie 3B,
00700 Helsinki
Tel: 658-9345-5400
Fax: 358-9345-5411
E-mail: sales@farnellinone.com

Intotel Oy

P.O. Box 125
Kutojantie 4
02631 Espoo
Tel: 358-9-521300
Fax: 358-9-755381
E-mail: Timo.Tikkalahti@intotel.fi

France

Arrow Electronique

21 rue du Jura
Siliç 585
94663 RUNGIS CDX
Tel: 33-1-49-78-49-00
Fax: 33-1-41-80-96-30
E-mail: tcourette@arrowfrance.com

Farnell In One

81-83 rue H. Depagneux
BP 60426 Limas
69654 VILLEFRANCHE/SAONE
Tel: 33-4-74-68-99-99
Fax: 33-4-74-68-99-90
E-mail: sales@farnellinone.com

Radiospares

ZA La Vatine
Rue Norman King
60031 BEAUVAIS CDX
Tel: 33-825-034-034
Fax: 33-825-345-000
E-mail: question.mail@rs-components.com

TTI

Le Voltaire
1 avenue Léo LaGrange
19100 Brive la Gaillarde
Tel: 33-5-55-92-92-93
Fax: 33-5-55-92-91-90
E-mail: fabien.carre@fr.ttiinc.com

Avnet Time

Zae des Glaises
6/8, rue Ambroise Croizat
91127 PALAISEAU CDX
Tel: 33-1-64-47-91-00
Fax: 33-1-64-47-91-50
E-mail: dominique.mailleret@avnet.com

Mateleco

ZAI des Bruyères
3 avenue Le Verrier
BP 116
78192 TRAPPES CDX
Tel: 33-1-30-13-73-80
Fax: 33-1-30-13-73 99
E-mail: bernard.franchet@mateleco.com

Rutronik

6 mail de l'Europe
78170 La CELLE ST CLOUD
Tel: 33-1-30-08-33-00
Fax: 33-1-30-08-33-90
E-mail: vramon@rutronik.com

Fiber Optics Distributors

0.3 dB la logistique de la Fibre Optique
27, rue du Général de Gaulle BP 12
95640-Marines-France
Tel: 33-1-30-30-92-03
Fax: 33-1-30-39-99-03
E-mail: contact@03db.com

Global Franchised Distributor Network

Europe (cont)

Germany

Avnet Time Munich

Gruber Straße 60 c
85586 Poing
Tel: 49-8121/7-77-03
Fax: 49-8121/77-7-535

E-mail: TimeGermany@Avnet.com

Deltron Components GmbH

Dieselstr. 11
71332 Waiblingen
Tel: 49-7151-95-300
Fax: 49-7151-18-162

E-mail: Info@deltron-components.de

Farnell InOne

Keltenring 14,
82041 Oberhaching Germany
Tel: 49-89-61-39-39-39
Fax: 49-89-61-35-59-01

E-mail: sales@farnellinone.com

MC Technologies GmbH

Ahrensburgerstraße 8
30659 Hannover
Tel: 49-511-67-69-99-0
Fax: 49-511-67-69-99-150

E-mail: zerber@mc-technologies.net

RS Components GmbH

Hessenring 13b
64546 Morfelden-Walldorf
Tel: 49-6105-401234
Fax: 49-6105-401109

E-mail: rs-gmbh@rs-components.com

Rutronik GmbH

Industriestr. 2
75224 Ispringen/Pforzheim
Tel: 49-7231-801-525
Fax: 49-7231-801-499

E-mail: alexander_martini@rutronik.com

SPOERLE

A Division of Arrow Central Europe
Max-Planck-Strasse 1-3
63303 Dreieich
Tel.: 49-6103-3048645
Fax: 49-6103-3048427

E-mail: spoerle@spoerle.com

TTI Inc. Deutschland

Ganghoferstr. 34
82216 Maisach-Gernlinden
Tel: 49-8142-6680-0
Fax: 49-8142-6680-199

E-mail: sales@de.ttiinc.com

Fiber Optics Distributors

0.3 dB la logistique de la Fibre Optique

27, rue du Général de Gaullen BP 12
95640-Marines-France
Tel: 33-0-1-30-30-92-03
Fax: 33-0-1-30-39-99-03

E-mail: contact@03db.com

Greece

Arrow Electronics Hellas

Elia Eliou 31
Athens 11743
Tel: 30-210-9020165
Fax: 30-210-9022118

E-mail: cdanos@arrowgr.com

Yiannikos Chr SA

4, Salaminos Str.,
141 23 Likovrissi
Athens
Tel: 0030-210-28-51-772
Fax: 0030-210-28-51-771

E-mail: info@giannikos.com

Fiber Optics Distributors

0.3 dB la logistique de la Fibre Optique

27, rue du Général de Gaullen BP 12
95640-Marines-France
Tel: 33-0-1-30-30-92-03
Fax: 33-0-1-30-39-99-03

E-mail: contact@03db.com

Ireland

Abacus Deltron

Foxhills Industrial Park
Scunthorpe
DN15 8QJ
Tel: 44-1724-281770
Fax: 44-1724-281650

E-mail: irishsales@deltron-uk.com

Abacus Polar Ireland

Mongret College Business Park,
Mongret, Limerick
Tel: 353-6148-0166
Fax: 353-6130-2777

Amtech

Unit 19C
Rosemount Business Park
Rosemount Park Drive
Ballycoolin Road
Dublin 15
Tel: 353-1-821-6444
Fax: 353-1-821-6355

Arrow Electronics Ltd

Block 10A, Beckett Way
Parkwest Business Park
Dublin 12
Tel: 353-1-6298700
Fax: 353-1-6298701

Avnet Time

Avnet House
Rutherford Close
Meadway
Stevenage
Herts SG1 2EF, UK
Tel.: 44-1438-788400
Fax: 44-1438-788240

E-mail: TimeUK@Avnet.com

Farnell InOne

3-5 Goffin Court,
Jamestown Road,
Finglas, Dublin 11 Ireland
Tel: 353-1-8309277
Fax: 353-1-8309016

E-mail: sales@farnellinone.com

TTI Ireland

2 Cliveden Office Village
Lancaster Road
Cressex Business Park
High Wycombe
Bucks, United Kingdom
HP123YZ

Tel: 44-1-494-460-000
Fax: 44-1-494-460-090

E-mail: sales.london@uk.ttiinc.com

Fiber Optics Distributors

0.3 dB la logistique de la Fibre Optique

27, rue du Général de Gaullen BP 12
95640-Marines-France
Tel: 33-0-1-30-30-92-03
Fax: 33-0-1-30-39-99-03

E-mail: contact@03db.com

Global Franchised Distributor Network

Europe (cont)

Italy

Abacus ECC Deltron

Via Volta 54
20090 Cusago (MI)
Tel: 39-02-90-39-71
Fax: 39-02-90-39-72-52
E-mail: cusago@eccabacus.it

Avnet Time

Via Manzoni, 44
20095 Cusano Milanino (MI)
Tel: 39-02-66092272
Fax: 39-02-66092332

DARTON SRL

Via Monte Amiata 27
I-20089 Rozzano (MI)
Tel: 39-02-57511101
Fax: 39-02-57511151

ELDECO di Brizzo SAS

Via Millio 36
I-10134 Torino
Tel: 39-011-3804068
Fax: 39-011-3806084
E-mail: g.brizzo@eldeco.it

Farnell InOne

Corso Europa, 20/22
20020
Tel: 39-02-93995200
Fax: 39-02-93995300
E-mail: sales@farnellinone.com

RS Components SPA

Via De Vizzi 93 / 95
20092 Cinisello Balsamo,
Milano
Tel: 39-02-66-0581
Fax: 39-02-66-058-051
E-mail: paolo.ferrigno@rs-components.com

SILVERSTAR LTD SPA

Viale Fulvio Testi 280
I-20126 Milano
Tel: 39-02-661251
Fax: 39-02-66101359
E-mail: msibillin@arrowitaly.com

TTI Italy

Sirada 1 Palazzo E1
I 20090 ASSAGO (MI)
Tel: 39-02-822521
Fax: 39-02-8225233
E-mail: sales.milan@it.ttiinc.com

WELT ELECTRONIC SRL

Via Della Treccia 33
I 50145 Firenze
Tel: 39-055-302-6345
Fax: 39-055-310-400
E-mail: colantoni@weltelectronic.it

Fiber Optics Distributors

0.3 dB la logistique de la Fibre Optique
27, rue du Général de Gaulle BP 12
95640-Marines-France
Tel: 33-1-30-30-92-03
Fax: 33-1-30-39-99-03
E-mail: contact@03db.com

Netherlands

Avnet Time

Takkebijsters 2,
4802 HV Breda
Tel: 31-76-57-22-300
Fax: 31-76-57-22-303
E-mail: TimeNL@Avnet.com

Farnell InOne

Zonnebaan 33, 3606 CH Maarsen
Tel: 313-0241-7373
Fax: 313-0241-7333
E-mail: sales@farnellinone.com

SPOERLE

A Division of Arrow Central Europe
Elzenkade 3,
3992 AD Houten
Tel: 31-30-63-91-234
Fax: 31-30-63-91-205
E-mail: SalesOffice.Utrecht@spoerle.com

TTI Inc.

Office Benelux
ESP 210,
5633 AC Eindhoven
Tel: 31-40-290-16-16
Fax: 31-40-290-16-10
E-mail: sales.benelux@nl.ttiinc.com

Fiber Optics Distributors

0.3 dB la logistique de la Fibre Optique
27, rue du Général de Gaulle BP 12
95640-Marines-France
Tel: 33-1-30-30-92-03
Fax: 33-1-30-39-99-03
E-mail: contact@03db.com

Compricon Nederland BV

Schootensdreef 1,
5708 HZ Helmond,
Tel: 31-492-593-000
Fax: 31-492-593 001
E-mail: sales@compricon.nl

Lunimpex BV

Amperestraat 2
6716 BN EDE
Tel: 31-318-486462
Fax: 31-318-485833
E-mail: verkoop@lunimpex.nl

Norway

Molex G. Knutsen AS

Brynsveien 16
0667 Oslo
Postbox 6104, Etterstad 0601
Tel: 47-23-039100
Fax: 47-23-039149

Global Franchised Distributor Network

Europe (cont)

Spain

ARROW IBERIA

Albasanz, 75
28037 Madrid
Tel: 34-917-61-70-05
E-mail: elisa@arrowiberia.com

Avnet Time

C/Mallorca, 1 al 23 2ª Planta 1º
08014 Barcelona
Tel: 34-933-27-85-30

Distribuidora de Conexiones DK, S.A.

Virgen del Luc, 42
28027 Madrid
Tel: 34-914-04-39-77
E-mail: info@Dkdist.com

ELECTRONICA ITEL, S.A.

Calle Energía 36
Poligono Industrial Famades
08940 Cornellà de Llobregat
Barcelona
Tel: 34-934-74-25-86
Fax: 34-934-74-33-85
E-mail: itelsa@itel.es

Farnell InOne

Parque Empresarial Cityparc,
Edificio Londres 2,
Cityparc Ronda de Datt,
Ctra. de Hospitalet, 147-149
08940 Cornellà, Barcelona
Tel: 34-901-20-20-80
Fax: 34-901-20-20-90
E-mail: sales@farnellinone.com

TTI

Parc Empresarial del Mediterrani
Passeig del Ferrocarril 339, 3-4a
08860 Castelldefels
Tel: 34-93-645-25-75
Fax: 34-93-699-47-33-15

Fiber Optics Distributors

0.3 dB la logistique de la Fibre Optique

27, rue du Général de Gaullen BP 12
95640-Marines-France
Tel: 33-1-30-30-92-03
Fax: 33-1-30-39-99-03
E-mail: contact@03db.com

Sweden

Arrow Nordic Components AB

Box 67
Kronborgsgrand 19
S-164 94 Kista
Tel: 46-8-56-26-5500
Fax: 46-8-56-26-5650
E-mail: arrownordic@arrownordic.com

Avnet Nortec AB

Englundavägen 7
Box 1830
S-171 28 Solna
Tel: 46-8-587-464-18
Fax: 46-8-587-464-01
E-mail: TimeSweden@Avnet.com

CLL CONNECTORS & CABLES AB

Rubanksvägen 3
74171 Knivsta-Ar
Tel: 46-18-349460
Fax: 46-18-349470
E-mail: cl@cll.se

Farnell InOne

Åldermansväg 21,
S-17148 Solna
Tel: 46-8-730-5000
Fax: 46-8-83-5262
E-mail: sales@farnellinone.com

TTI Electronics Sweden

Johanneslundsvägen 2
S-194 61 Upplands-Vasby
Tel: 46-8-594-118-23
Fax: 46-8-594-118-01
E-mail: sales.stockholm@se.ttiinc.com

Fiber Optics Distributors

Micropol Fiberoptic AB

P.O. Box 46
S-313 03 Åled
Visiting Address: Älvdalsvägen 4
Tel: 46-35-392-33
Fax: 46-35-392-70
E-mail: a.a@micropol.se

Switzerland

Avnet Time

Bernstrasse 392
8953 Dietikon
Tel: 41-43-322-49-90
Fax: 41-43-322-49-99
E-mail: TimeSwitzerland@Avnet.com

EME AG

Interconnection & Motion
Lohwisstrasse 50
8123 Ebmatingen
Tel: 41-1-9821111
Fax: 41-1-9821122
E-mail: info@eme.ch

Farnell InOne

Brandschenkestrasse 178,
8027 Zurich
Tel: 41-1-204-64-64
Fax: 41-1-204-64-54
E-mail: sales@farnellinone.com

SPOERLE

A Division of Arrow Central Europe
Riedmatt 9
8153 Rümlang
Tel: 41-1-8176-217
Fax: 41-1-8176-200
E-mail: Vertrieb.Zuerich@spoerle.com

Global Franchised Distributor Network

Europe (cont)

UK

Abacus Deltron

Foxhills Industrial Park
Scunthorpe DN15 8QJ
Tel: 44-1724-281770
Fax: 44-1724-281650
E-mail: sales@deltron-uk.com

Abacus Polar

Abacus House
Bone Lane
Newbury
Berkshire RG14 5SF
Tel: 44-1635-36222
E-mail: emap@abacus.co.uk

Arrow Electronics UK Ltd

Edinburgh Way
Harlow
Essex CM20 2DF
Tel: 44-1279-441144
Fax: 44-1279-455522
E-mail: enquiry@arrowuk.com

Avnet Time

Avnet House
Rutherford Close
Meadway
Stevenage
Herts SG1 2EF
Tel: 44-1438-788400
Fax: 44-1438-788240
E-mail: TimeUK@Avnet.com

Farnell InOne

Canal Road
Leeds LS12 2TU
Tel: 44-870-1227711
Fax: 44-113-2792809
E-mail: sales@farnellinone.com

Flint Distribution Ltd

Walker Road
Bardon Hill
Coalville
Leicestershire
LE67 1TU
Tel: 44-1530-511248
Fax: 44-1530-511249
E-mail: garybeeby@flint.co.uk

RS Components

PO Box 99
Birchington Road
Weldon
Corby
Northants
NN17 9RS
Tel: 44-1536201234
Fax: 44-1536405461
E-mail: general@rswww.com

TTI

2, Cliveden Office Village
Lancaster Road
Cressex Business Park
High Wycombe
Bucks HP12 3YZ
Tel: 44-1494-460000
Fax: 44-1494-460090
E-mail: sales@uk.ttiinc.com

Fiber Optics Distributors

0.3 dB la logistique de la Fibre Optique

27, rue du Général de Gaulle BP 12
95640-Marines-France
Tel: 33-0-1-30-30-92-03
Fax: 33-0-1-30-39-99-03
E-mail: contact@03db.com

Bulgaria

Rutronik

Elektronische Bauelemente GmbH
ul. Cherkovna No. 57
Office No. 16
1505 Sofia
Tel: 359-2-9430330
Fax: 359-2-9430331
E-mail: rutronik_bg@rutronik.com

TTI Inc

Diófa u. 130
1162 Budapest
Tel: 36-1-4020807
Fax: 36-1-4020808
Email: sandor.fekete@de.ttiinc.com

Silverstar Ltd SPA

Viale Fulvio Testi 280
I-20126 Milano, Italy
Tel: 39-02-661251
Fax: 39-02-66101359
E-mail: msibillin@arrowitaly.com

Farnell InOne Export (Sales)

Canal Road
Leeds LS12 2TU
UK
Tel: 44-870-1200-208
Fax: 44-870-1200-209
E-mail: export@farnellinone.com

Croatia

IR Electronic d.o.o. (Arrow Slovenia)

Ziherlova 2, 1000 Ljubljana,
Slovenia
Tel: 386-1-420-13-82 or 91
Fax: 386-1-283-56-05
E-mail: bzaletelj@arrowslovenia.com
E-mail: acatak@arrowslovenia.com

Avnet Time Slovenia

Dunajska 22, Ljubljana 1000,
Slovenia
Tel: 386-1-430-14-63
Fax: 386-1-430-16-64
E-mail: tea.filipic@avnet.com

Global Franchised Distributor Network

Eastern Europe

Czech Republic and Slovakia

**Arrow Electronics
Czech Republic s.r.o.**
Charkovská 24,
101 00 Praha 10,
Czech Republic
Tel: 420-271-742-000
Fax: 420-271-742-001
E-mail: SalesOffice.Prague@spoerle.com

Farnell InOne Export (Sales)
Canal Road
Leeds
LS12 2TU
UK
Tel: 44-870-1200-208
Fax: 44-870-1200-209
E-mail: export@farnellinone.com

Official Electronic, s.r.o.
U Tescomy 254
76001 Zlín - Priluky
Czech Republic
Tel: 420-577-525-261
Fax: 420-577-525-263
E-mail: official@official.cz

Rutronik CZ spol.s.r.o.
Slavickova 1a
63800 Brno
Czech Republic
Tel: 420-545-193-517
Fax: 420-545-222-256
E-mail: jaromir_sevela@rutronik.com

TTI Czech
TTI Inc./Amtech, sro
Banskobystricka 141
621 00 Brno
Czech Republic
Tel: 420-541-225-215
Fax: 420-541-225-292
E-mail: filip.vostal@de.ttiinc.com

TTI Slovakia
TTI Slovakia/Tenon, sro
Kubániho 16
811 04 Bratislava
Slovakia
Tel: 421-268-245-910
Fax: 421-268-245-910
E-mail: lucia.kristek@de.ttiinc.com

Fiber Optics Distributors

**0.3 dB la logistique
de la Fibre Optique**
27, rue du Général de Gaullen BP 12
95640-Marines-France
Tel: 33-1-30-30-92-03
Fax: 33-1-30-39-99-03
E-mail: contact@03db.com

Hungary

Arrow Central Europe
Váci út 140,
H-1138 Budapest
Tel: 36-1-2887300
Fax: 36-1-2887301
E-mail: SalesOffice.Budapest@Spoerle.com

Farnell
FaDiHu Kft.
Zólyomi út 3.
1118. Budapest
Tel: 36-1-3199805
Fax: 36-1-3095066
E-mail: fadihu@fadi.hu

Rutronik Magyarország Kft.
Fehérvári út 89-95
H-1119 Budapest
Tel: 36-1-3710666
Fax: 36-1-3710667
E-mail: rutronik_h@rutronik.com

TTI Inc.
Diófa u. 130
-1162 Budapest
Tel: 36-1-4020807
Fax: 36-1-4020808
E-mail: sandor.fekete@de.ttiinc.com

World Components
Gárdonyi G. u 8-9
H-9200 Mosonmagyaróvár
Tel: 36-96-578070
Fax: 36-96-578077
E-mail: woco@woco.hu

Poland

Arrow Central Europe
ul. Sasiedzka 110/28
764 Warszawa
Tel: 48-22-558-8282
Fax: 48-22-558-8283
E-mail: RvonDaak@spoerle.com

Avnet EM Sp. z.o.o.
Plac Solny 16
50-062 Wrocław
Tel: 48-71-342-05-99
Fax: 48-71-342-29-10
E-mail: remigiusz.jurek@avnet.com

Farnell InOne Export (Sales)
Canal Road
Leeds
LS12 2TU UK
Tel: 44-870-1200-208
Fax: 44-870-1200-209
E-mail: export@farnellinone.com

**TME Transfer Multisort Elektronik
Sp.z.o.o.**
ul. Ustronna 41
93-350 Lodz
Tel: 48-42-645-54-00
Fax: 48-42-645-55-00
E-mail: molex@tme.pl

TTI Inc.
ul. Lotnicza 2
82-500 Kwidzyn
Tel: 48-55-279-67-57
Fax: 48-55-279-75-50
E-mail: katarzyna.rutka@de.ttiinc.com

Romania

Farnell InOne Export (Sales)
Canal Road
Leeds
LS12 2TU UK
Tel: 44-870-1200-208
Fax: 44-870-1200-209
E-mail: export@farnellinone.com

Rutronik
Elektronische Bauelemente GmbH
Maresal C-tin Prezan 142
300695 Timisoara, Romania
Tel: 40-25-64-01-242
Fax: 40-25-64-01-242
E-mail: rutronik_ro@rutronik.com

TTI Romania/Telezimex S.A.
Calea Turzii Nr. 231-233
400495 Cluj-Napoca
Tel: 40-264-43-91-03
Fax: 40-264-43-91-06
E-mail: mircea.boar@de.ttiinc.com

Global Franchised Distributor Network

Eastern Europe (cont)

Russia

Arrow Central Europe

ul. Konjushkovskaya, 28
123242 Moscow
Tel: 7-495-926-55-97
Fax: 7-495-926-55-98

E-mail: SalesOffice.Moscow@spoerle.com

Farnell InOne Export (Sales)

Canal Road
Leeds LS12 2TU UK
Tel: 44-870-1200-208
Fax: 44-870-1200-209

E-mail: export@farnellinone.com

ITC Electronics

82/1, Krasnyi Prospekt
630091 Novosibirsk
Tel: 8-800-200-8208,
7-383-22-77-888

ITC Electronics Moscow

Radiost. 24
105005 Moscow
Tel: 7-495-775-18-45
Fax: 7-495-775-18-48

E-mail: moscow@itc-electronics.com

Macro Team

Zelenyi Prospekt,
Bld. 3 2/19
111141 Moscow
Tel: 7-495-306-0026
Fax: 7-495-306-0283

Roman Pinchuk
E-mail: molex@macroteam.ru

Petersburg Electronic Company

2 Pobedy Square
196143 St. Petersburg
Tel: 7-812-373-0063
Fax: 7-812-373-5257

Vladimir Starostin
E-mail: pec@pec.spb.ru

Rutronik

Beteiligungsgesellschaft mbH
Leningradskoje Chaussee 16
Building 3, Office 403
125171 Moscow
Tel: 7-495-15-99-255

E-mail: rutronik_ru@rutronik.com

Slovenia

Avnet Time

Dunajska cesta 159,
1000 Ljubljana
Tel: 386-0-1-5609-754 or 756
Fax: 386-0-1-5609-878

E-mail: tea.filipic@avnet.com

Farnell InOne Export (Sales)

Canal Road
Leeds
LS12 2TU UK
Tel: 44-870-1200-208
Fax: 44-870-1200-209

E-mail: export@farnellinone.com

IR Electronic d.o.o. (Arrow Slovenia)

Zihelova 2, 1000 Ljubljana
Tel: 386-1-420-13-82 or 91
Fax: 386-1-283-56-05

E-mail: bzaletelj@arrowslovenia.com
E-mail: acatak@arrowslovenia.com

Rutronik Elektronische Baulement GmbH

Brciceva 13
1213 Ljubljana - Crnuce
Tel: 38-61-561-1458
Fax: 38-61-561-2053

E-mail: rutronik_si@rutronik.com

Ukraine

Arrow Central Europe

Glubochitskaya Street 40
04050 Kiev, Ukraine
Tel: 380-44-4597021
Fax: 380-44-4597021

E-mail: salesoffice.kiev@spoerle.com

Farnell InOne Export (Sales)

Canal Road
Leeds LS12 2TU UK
Tel: 44-870-1200-208
Fax: 44-870-1200-209

E-mail: export@farnellinone.com

ITC Electronics Kiev

pr. Vossoyedeniya 7a
Office 107
02160 Kiev, Ukraine
Tel: 380-44-559-68-90
Fax: 380-44-501-13-03

E-mail: kiev@itc-electronics.com

Rutronik

Beteiligungsgesellschaft mbH
Leningradskoje Chaussee 16
Building 3, Office 403
125171 Moscow, Russia
Tel: 7-495-15-99-255

E-mail: rutronik_ru@rutronik.com

SEA

Krakovskaya str. 36/10
02094 Kiev
Tel: 380-44-575-94-10
Fax: 380-44-575-94-03

E-mail: info@sea.com.ua

Global Franchised Distributor Network

Asia

Hong Kong

Arrow Asia Pac Ltd.

20/F, Tower 2,
Ever Gain Plaza
88 Container Port Road,
Kwai Chung
Hong Kong
Tel: 852-2484-2484
Fax: 852-2484-2128
E-mail: Louisa.Lui@arrowasia.com

Chinatronic Technology Ltd.

16/F, Spectrum Tower
53 Hung To Road, Kwun Tong
Hong Kong
Tel: 852-2176-5180
Fax: 852-2376-2142

Antech (H.K.) Company

Unit 902C, 9/F Sunbeam Centre,
27 Shing Yip Street, Kwun Tong,
Kowloon, Hong Kong
Tel: 852-2172-7889
Fax: 852-2172-7880
E-mail: Catherine@abacusaic.com.tw

Che Fung Enterprise

2212 Tsuen Wan Industrial Centre
220 Texaco Road,
Tsuen Wan, N.T.
Hong Kong
Tel: 852-2408-6039
Fax: 852-2407-6108
E-mail: hongkong@chefung.com

Hua Tong Connector Co., Ltd.

Ft. C, 9/F, Chen Yip Ind. Bldg.
5 Lai Yip St.
Kwun Tong, Kowloon
Hong Kong
Tel: 852-2790-5026
Fax: 852-2790-5812
E-mail: sales@huaconn.cn

Long Think Enterprise (HK) Co., Ltd.

Flat F, 17/F, Universal Ind. Centre,
23-25 Shan Mei Street,
Fotan, Shatin
Hong Kong
Tel: 852-2687-6262
Fax: 852-2687-6267
E-mail: longthink@netvigator.com

Ohnishi Denki (HK) Limited

Unit 3012-13, Level 30,
Metroplaza Tower 1,
223 Hing Fong Road, Kwai Fong,
Kwai Chung, N.T.,
Hong Kong
Tel: 852-2314-9141
Fax: 852-2396-9737
E-mail: ohrachel@biznetvigator.com
Contact: Ms. Rachel Ho

Marubun/Arrow (HK) Ltd.

Suites 1706-07, 17/F, Tower 6,
The Gateway
9 Canton Road
Tsim Sha Tsui, Kowloon,
Hong Kong
Tel: 852-2273-0013
Fax: 852-2273-0014
E-mail: tomoaki.higuchi@
marubunarrow-asia.com

**Shenzhen Mansion
Technology Limited**

(Hong Kong Office)
Rm 2803-05,28/F,
Well Fung Ind. Centre,
68 Ta Chuen Ping St.,
Kwai Chung, NT. Hong Kong
Tel: 852-2487-6006
Fax: 852-2422-8290
E-mail: kfyuen@hungshang.com.hk

TTI Hong Kong Limited

Unit 607, 6/F, Lu Plaza
2 Wing Yip Street, Kwun Tong,
Kowloon, Hong Kong
Tel: 852-2628-0970
Fax: 852-2628-0966
E-mail: anthony.chan@ttiinc.com
Contact: Anthony Chan

China - South

Arrow Electronic (Shenzhen) Co., Ltd.

No. 109-112 Building
International Commerce
& Exhibition Center
No. 1001 Honghua Road
Futian Free Trade Zone
Shenzhen, People's Republic of China
Tel: 86-755-8359-2920 ext. 25416
Fax: 86-755-8359-2377
E-mail: catherine.wang@arrowasia.com

Antech (H.K.) Company

1F-2, No. 3, JiangBei, WuSha,
ChangAn Town,
DongGuan City, Guangdong Province
People's Republic of China
Tel: 86-769-8549-9849/9949
Fax: 86-769-8549-9719
E-mail: alex@abacusaic.com.tw

Chinatronic Technology Ltd.

10/F Block A,
Electronics Science & Tech Bldg
No. 2070 Shennan Rd,
Central Shenzhen
People's Republic of China
Tel: 86-755-8378-1886 Ext. 1462/1420
E-mail: Shiny.Li@avnet.com

More & Long Ltd.

Hua Sheng Ind. Zone,
Dalang LongHua Baoan, Shenzhen,
China, People's Republic of China
Tel: 86-755-2-8138-344
Tel: 86-755-2-8138-345
Fax: 86-755-2-8138-352
E-mail: winnie@sinyue.com.tw

Shanghai Chefung**Wire Harness Equipment Co., Ltd.**

(Shenzhen Branch)
3/F, 56, Jian Se Nan Road,
Beijiao, Shunde
People's Republic of China
Tel: 86-765-665-3559
Fax: 86-765-666-1420
E-mail: sde@chefung.com
Contact: Ms. Lin Huan Qun

ShenZhen Deren Electronic Co., Ltd.

Room 1710/1718, Cyber Times Tower A
Tianan Cyber Park
Futian, Shenzhen
People's Republic of China
Tel: 86-755-8347-6677
Fax: 86-755-8347-6521
E-mail: Chenjie@deren.com.cn

**Shenzhen Mansion
Technology Limited**

1/F, 9~10/F, Bao Yu Building,
Xin An 5 Road, 52 District, Xin Cheng
Bao An, Shen Zhen
People's Republic of China
Tel: 86-755-2751-5862
Fax: 86-755-2789-3069
E-mail: kfyuen@hungshang.com.hk

Shilong Huatong Electronic Co., Ltd.

4/F, 11, Weixin Road
Shilong Town, Dongguan City
Guangdong Province,
China, People's Republic of China
Tel: 86-769-8660-7176
Fax: 86-769-8660-7200
E-mail: sales@huaconn.cn

Global Franchised Distributor Network

Asia (cont)

China - Central

Abacus (Shanghai) International

Rm807, No.1, Jilong Rd,
Waigaoqiao Free Trade Zone
200131, Pudong Shanghai
Tel: 86-21-5869-1798
Fax: 86-21-5869-6790

E-mail: mark@abacusaic.com.tw

Arrow Electronics (Shanghai) Ltd.

6/F, Building 1, Zhangjiang
RiverFront Harbor,
3000 Long Dong Avenue,
Shanghai 201203
Tel: 86-21-2893-2000
Fax: 86-21-2893-2333

E-mail: Daniel.zhu@arrowasia.com

Chinatronic Technology Limited

North China Region (Avnet)
21/F, Strength Plaza, No. 3,
Lane 600, Tianshang Rd,
200051, Shanghai
People's Republic of China
Tel: 86-21-5206-2288
Fax: 86-21-5206-2299

E-mail: Irene.Deng@Avnet.com

Long Think International Trading (Shanghai) Co., Ltd.

Room 217, No. 728 XinHua Road
Shanghai 200052
People's Republic of China
Tel: 86-21-6294-6472
Fax: 86-21-6280-8741

E-mail: tung@longthink.com.tw
Attn: Tung Wang

Panasonic International Trading (Shanghai) Co., Ltd.

9th Floor, HSBC Tower,
1000 Lujiazui Ring Road,
Pudong New Area,
Shanghai 200120,
People's Republic of China
Tel: 86-21-6841-2589
Fax: 86-21-6841-2030

E-mail: shin-w@mttco.co.jp
Attn: Shin Watanabe

Shanghai Chefung WireHarness Equipment Co. Ltd.

Rm 112, Longjiang Building
No. 260 Nan Xun Rd,
200080, Shanghai
People's Republic of China
Tel: 86-21-63071518
Fax: 86-21-63936250

E-mail: ch Wong@chefung.com
Attn: C. H. Wang

Shanghai Hongyi Trading Co., Ltd.

4/F, No. 2 Building, 115 Tianlin Rd,
200233, Shanghai
People's Republic of China
Tel: 86-21-5448-4690
Fax: 86-21-5448-4681

E-mail: connector@hongyitrade.com
Attn: Bob Ye

Shanghai TTI Electronics Co., Ltd.

2303 Room, 23rd Floor
Wise Logic International Central
No. 66 Shaan Xi Road, Shanghai 200041
People's Republic of China
Tel: 86-21-5153-1386
Fax: 86-21-5153-1383

E-mail: Dennis.Tang@ttiinc.com
Attn: Dennis Tang

Suho Precise Component Co., Ltd.

Bulding 9-1,
FengYi Quarter FengYi Street
DongHuan Road,
Suzhou City, 215021
People's Republic of China
Tel: 86-512-6745-1315
Fax: 86-512-6748-8412

E-mail: saul@suhoprecise.com
Attn: Saul Yi

China - North

Beijing Gold Zhida Technology Ltd.

Rm 1604, Tri-tower B Building,
No. 66 Zhongguancun East Road,
Haidian District
Beijing 100080,
People's Republic of China
Tel: 010-6267-0360, 62670598,
62670865
Fax: 010-62670956

E-mail: qxf@gold-zhida.com
Contact: Qiao XianFang

Qingdao Yiyang Electronic Co., Ltd.

No 153 Yichun Road
Qingdao, People's Republic of China
Tel: 86-0532-598-5611
Tel: 86-0532-598-9361
Fax: 86-0532-598-5642

E-mail: YIYANG-QD@163.COM
Contact: Mr. William Wang
Contact: Mr. Henry Li

India

Arrow Electronics India Pvt. Ltd.

(Bangalore Branch)
#26, 4th Floor, Akshaya Commercial Complex
Victoria Road,
Bangalore 560 047, India
Tel: 91-80-4135-3800
Fax: 91-80-4112-7784

E-mail: rakesh.thakar@arrowasia.com

Avnet India Private Limited

2nd Floor, "The Estate"
121, Dickenson Road,
Bangalore 560 042, India
Tel : 91-80-2532-3420
Fax: 91-80-2532-3747

E-mail: Debasis.Panda@avnet.com

East West Automation Pvt. Ltd.

106, Vinoba Puri, Lajpat Nagar-II,
New Delhi 110 024, India
Tel: 91-11-6542-5642/5643
Fax: 91-11-2984-4547

E-mail: eastwest1@rediffmail.com

Ingram Micro Pvt Ltd

Gate No.1A, Godrej Industries Complex
Pirojshanagar, Vikhroli East
Mumbai, Maharashtra 400 079, India
Tel: 91-22-6796-0127
Fax: 91-22-2518-8236

E-mail: sandeep.p@ingrammicro.co.in
semiconductors@ingrammicro.co.in

Parag Distributors

Shamli Soc., Flat 1
120, Prabhat Rd, Erandwane
Pune-411 004
Maharashtra, India
Tel: 91-20-2546-0236
Fax: 91-20-2544-3233

E-mail: paragaher@vsnl.com

Spectra Connectronics Pvt. Ltd.

52B Chotani Building First Floor,
Prator Road off Lamington Road
Mumbai 400 0071, India
Tel: 91-22-6636-1999
Fax: 91-22-2380-2753

E-mail: purchase@spectraconnectronics.com

Viswas Trading Company

25/1, 3rd Floor, Vinod Complex
J.C. Road
Bangalore 560 002, India
Tel: 91-80-4124-0595/2223 3925
Fax: 91-80-4157-5677

E-mail: viswastading@airtelbroadband.in

Global Franchised Distributor Network

Asia (cont)

Indonesia

PT GSK Electronics Indonesia

Ariobimo Sentral, 4th Floor
Jl.H.R. Rasuna Said Kav.X-2/5
Jakarta 12950 Indonesia
Tel: 62-21-252-5746
Fax: 62-21-252-5755
Email: daryl@gsk.com.sg

Pt. Novalux Indonesia

Gedung BRI II 15th Floor
Suite # 1500A
Jl. Jendral Sudirman
No. 44-46
Jakarta 10210, Indonesia
Tel: 62-21-574-4059
Fax: 62-21-574-4042
E-mail: ogata@novalux.co.id

TECK International Pte. Ltd.

Kawasan Niaga Sentra Eropa Blok E/12
Kota Wisata - Cibubur
Jakarta - 16968
Tel/Fax: 62-21-84932371
E-mail: tm.low@lionex-teck.com.sg

Malaysia

Arrow Components (M) Sdn Bhd

Unit 18.01A, 18/F, Menara PSCI
39 Jalan Sultan Ahmad Shah, 10050,
Penang, West Malaysia
Tel: 60-4-229-6613
Fax: 60-4-229-6623
E-mail: steven.toh@arrowasia.com

Arrow Components (M) Sdn Bhd

No. 608, Block A,
Kelana Business Centre,
97 Jalan SS7/2,
Kelana Jaya,
47310 Petaling Jaya, Selangor.
Tel: 03-7804-6313
Fax: 03-7804-6213
E-mail: steven.toh@arrowasia.com

Avnet Malaysia Sdn Bhd

Penang Branch
1-4-16, Krystal Point Corporate Park,
Lebuh Bukit Kecil 6,
11900 Bayan Lepas
Penang, Malaysia
Tel: 604-646-1837
Fax: 604-646-1950
E-mail: claire.kee@avnet.com

Avnet Malaysia S/B (KL)

24-1, Jalan Medan Setia 2,
Plaza Damansara, Bukit Damansara,
50490 Kuala Lumpur,
Malaysia
Tel: 03-2093-9721/9722
Fax: 03-2093-9723
E-mail: SC.Teng@avnet.com

Farnell Components (M) Sdn Bhd (376822-U)

Lot 14, Jalan 51A/227, 46100 Petaling
Jaya, Selangor Darul Ehsan, Malaysia
Tel: 00-60-3-7873-8000
Fax: 00-60-3-7873-7000
E-mail: malaysia-sales@farnell.com

GSKP Electronics Sdn Bhd

Level 3, Unit 11, Krystal Point II,
No 1, Lebuh Bukit Kecil 6,
11900 Bayan Lepas
Penang, Malaysia
Tel: 604-6424889/6427889
Fax: 604-6427890
Email: chris@gsk.com.sg

GSKP Electronics Sdn Bhd

Endah Ria Condominium
C-06-14 Jalan 3/149E
Taman Sri Endah, Bandar Baru Sri Petaling
57000 Kuala Lumpur, Malaysia
Tel: 603-9057-5107
Fax: 603-9057-3107
E-mail: chris@gsk.com.sg

WPI Components Sdn Bhd (Kuala Lumpur)

23-1 & 25-1 (Ground Floor), Block D1
Dataran Prima, Jalan PJU 1/41
47301 Petaling Jaya
Selangor, Malaysia
Tel: 603-7880-8309 Ext. 1200
Fax: 603-7880-8310
E-mail: bc.hia@wpgintl.com

WPI Components Sdn Bhd

Unit 13, 14 (Lower Level 6)
Hotel Equatorial Penang
No 1, Jalan Bukit Jambul,
11900 Bayan Lepas
Penang, Malaysia
Tel: 604-642-9500
Fax: 604-642-9499
E-mail: bh.wong@wpgintl.com

Philippines

Arrow Electronics Labuan Pte. Ltd.

26th Floor Tower 1,
Insular Life Corporate Centre,
Filinvest Corporate City, Alabang
1770 Muntinlupa City, Philippines
Phone: 632-772-3053/55/56
Fax: 632-772-3054
E-mail: Mario.Rivero@arrowasia.com
Contact: Mario Rivero

Avnet Philippines Pty Ltd Inc

1505 Richville Corporate Tower
1107 Alabang Zapote Road
Madrigal Business Park, Ayala Alabang
Muntinlupa City, Philippines 1780
Tel: 632-772-4201/02/03
Fax: 632-772-4204
E-mail: Rommel.DelaCruz@Avnet.com
Contact: Rommel Dela Cruz

Cinergi Tech & Devices

Rm 1002, 10F, South Center Tower
2206 Market Street
Madrigal Business Park
Alabang, Muntinlupa City 1770,
Philippines
Tel: 632-842-6567
Fax: 632-842-0185
E-mail: rj.cabrera@cinergitech.com

Marubun/Arrow Phils.-Inc.

2nd Floor, MDD Building
121 East Science Avenue
Laguna Technopark, Special Economic Zone
Binan, Laguna 4024 Philippines
Tel: 63-49-541-3356
Tel: 63-49-541-3357
Fax 63-49-541-2977
E-mail: Yasutika.Matsousa@
marubunarrow-asia.com
Contact: Yasutika Matsuoka

Global Franchised Distributor Network

Asia (cont)

Singapore

Arrow Electronics (S) Pte. Ltd.
750E Chai Chee Road #07-01/02,
Technopark @ Chai Chee
Singapore 469005
Tel: 65-845-8388
Fax: 65-845-8227
E-mail: Wilson.Thoo@arrowasia.com

Avnet Asia Pte. Ltd.
151 Lorong chuan #06-03
New Tech Park
Singapore 556741
Tel: 65-6580-6000
Fax: 65-6580-6122
E-mail: David.Pong@avnet.com
Contact: David Pong

WPI International (S) Pte. Ltd.
53 Ubi Road 1
Singapore 408698
Tel: 65-6282-5188
Fax: 65-6282-9251
E-mail: munchoy.chow@wpgintl.com

Empire Components Pte. Ltd.
887 Defu Lane 10 # 06-00
MEC TechnoCentre
Singapore 539219
Tel: 65-6288-2593
Fax: 65-6284-0538
E-mail: cyuen@mec.com.sg
Contact: Carrie Yuen

Farnell Components Pte. Ltd.
15 Tai Seng Drive, Singapore 535220
Tel: 00-65-788-0200
Fax: 00-65-788-0300
E-mail: singaporeales@farnell.com

GSK Electronics Pte. Ltd.
15 Shaw Road
#06-01/02
Teo Industrial Building
Singapore 367953
Tel: 65-6284-8011
Fax: 65-6284-5011
E-mail: grene@gsk.com.sg

TTI Electronics Asia Pte. Ltd.
3 Changi North Street 2 #03-01B
Trivec Building
Singapore 498827
Tel: 65-6788-9200
Fax: 65-6788-9300
E-mail: Vincent.Chua@ttiinc.com
Contact: Vincent Chua

Marubun/Arrow (S) Pte. Ltd.
77 Robinson Rd #21-02 SIA Building
Singapore 068896
Tel: 65-6536-0050
Fax: 65-6536-2400
E-mail: gh.ye@marubunarrow-asia.com
Contact: Ye GuanHan

Taiwan

Arrow Electronics Taiwan Ltd.
(Head Office - Taipei)
19/E, No. 75, Hsin Tai Wu Road,
Hsi Chih, Taipei,
Taiwan, Republic of China
Tel: 886-2-2698-2889
Fax: 886-2-2698-2901
E-mail: Anderson.Lo@arrowasia.com

Arrow Electronics Taiwan Ltd.
(Hsin Chu)
No. 75, Chin San 23 Street,
Hsin Chu City 300
Taiwan, Republic of China
Tel: 886-35-788-138
Fax: 886-35-788-440
E-mail: peter.lin@arrowasia.com

Avnet Electronics Marketing
Avnet Asia Pte Ltd, Taiwan Branch
(Singapore)
5F, no. 3, Yuan Cyu Rd.,
(Nankang Software Park)
Taipei, Taiwan
Republic of China
Tel: 886-2-2655-8688 #838
Fax: 886-2-2655-8666
E-mail: Lily.Fan@avnet.com

Abacus International Co., Ltd.
3F-1, No. 192, Ruei-Guang Road,
Nei-Hu, Taipei
Taiwan, Republic of China
Tel: 886-2-2797-5598
Fax: 886-2-2798-5828
E-mail: alex@abacusaic.com.tw

Long Think Enterprise Co., Ltd.
3F, No. 162, Dah-Yeh Rd. Peitou
Taipei
Taiwan, Republic of China
Tel: 886-2-2898-6899
Fax: 886-2-2898-6820
E-mail: jack@longthink.com.tw

Sinyue Enterprise Co., Ltd.
4F, No. 66-8 Sec. 2, Nan Kan Road, Lu Chu,
Taoyuan Hsien, Taipei
Taiwan, Republic of China
Tel: 886-3321-5588
Fax: 886-3321-5533
E-mail: winnie@sinyue.com.tw

Thailand

GSK Electronics (Thailand) Co., Ltd.
11th Fl, Zone B1
222 Thansekkaj Bldg.
Vibhavadi-Rangsit rd., Ladyao
Chatuchak, Bangkok
Tel: 662-512-0477
Fax: 662-512-0478
E-mail: nicky@gsk.com.sg
Contact: Nicky

Marubun Arrow (Thailand) Co., Ltd.
Unit 2907-2908,
29th floor, Empire Tower
195 South Sathorn rd., Yannaw
Sathorn, Bangkok
Tel: 662-670-0770
Fax: 662-670-0780
E-mail: hideyuki.ogura@
marubunarrow-asia.com

Global Franchised Distributor Network

Australia/Middle East/New Zealand

Australia

Adilam Electronics Pty. Ltd.

14 Nicole Close
Bayswater, Victoria 3153
Tel: 61-3-9737-4900

E-mail: robert.haddick@adilam.com.au

Arrow Electronics Australia Pty. Ltd. (Melbourne Head Office)

9-10 Bastow Place,
Mulgrave, Victoria 3170
Tel: 61-3-9574-9300
Fax: 61-3-9574-9773

E-mail: rob.monteath@arrowasia.com

Arrow Electronics Australia Pty. Ltd. (Sydney Office)

Suite 301, Building A
240-244 Beecroft Road
Epping, NSW 2121
Tel: 61-2-9868-9900
Fax: 61-2-9868-9901

E-mail: richard.searle@arrowasia.com

Arrow Electronics Australia (Brisbane Office)

Unit 2A 23 Vauxhall Street
Virginia, QLD 4014
Tel: 61-7-3623-9000
Fax: 61-7-3216-5750

E-mail: russell.oakes@arrowasia.com

Arrow Electronics Australia (Adelaide Office)

Suite 8, The Parks
154 Fullarton Road,
Rose Park, S.A 5067
Tel: 61-08-8333-2122
Fax: 61-08-8333-2322

E-mail: ian.wallis@arrowasia.com

Arrow Electronics Australia (Perth Office)

Western Australia Suite 1
64 Canning Highway
Victoria Park, W.A. 5100
Tel: 61-8-9472-3855
Fax: 61-8-9470-3273

E-mail: steve.squires@arrowasia.com

Avnet Sydney

2 Giffnock Avenue
North Ryde
New South Wales 2113
Australia
Tel: 61-02-9878-1299
Fax: 61-02-9878-1266

E-mail: Australia.Sales@avnet.com

Avnet Adelaide

PO Box 742
Brighton SA 5048
Australia
Tel: 1300-888364
Fax: 61-2-9878-1266

E-mail: Australia.Sales@avnet.com

Avnet Brisbane

PO Box 3228
Bracken Ridge QLD 4017
Australia
Tel: 1300-888364
Fax: 61-2-9878-1266

E-mail: Australia.Sales@avnet.com

Avnet Melbourne

PO Box 767
Bayswater VIC 3153
Australia
Tel: 1300-888364
Fax: 61-2-9878-1266

E-mail: Australia.Sales@avnet.com

Captron Pty. Limited

PO Box 884
Brookvale
New South Wales 2100 Australia
Tel: 61-2-9905-5888 or
Toll free: 800-813-838/
Tel: 61-2-9905-5851 or
Toll free: 800-995-851

E-mail: info@captron.com.au

Farnell Components

72 Ferndell Street
NSW 2162, Australia
Tel: 61-2-9644-7722
Fax: 61-2-9644-7898

E-mail: ausales@farnell.com

Middle East

Israel

Arrow Rapac Ltd.

60 Amal St. Kiryat-Arieh
49130 Petach-Tikva, Israel
Tel: 972-3-9203456
Fax: 972-3-9203443

Telsys Ltd

Atidim, Bldg 3, Dvora
Hanevia Str. Neve Sharet
61431 Tel Aviv, Israel
Tel: 972-3-7657660
Fax: 972-3-6497407

Turkey

Arrow Elektronik Ticaret A.Ş.

Çayırlyolu Sok. Üçgen Plaza No: 7 Kat: 8
81120 İçerenköy, Istanbul
Turkey
Tel: 90-216-5751820
Fax: 90-216-5751830

E-mail: oyilmaz@arrowtr.com

Alfa Elektronik San. ve Tic. Ltd. Şti.

Yenisahra Mahallesi
Mimar Sinan Cad.
No: 2/A, Kadikoy,
34746 Istanbul,
Turkey
Tel: 90-216-472-83-17
Fax: 90-216-472-83-22
E-mail: alfa@al-fa.com.tr

Fiber Optics Distributors**0.3 dB la logistique de la Fibre Optique**

27, rue du Général de Gaulle BP 12
95640-Marines-France
Tel: 33-0-1-30-30-92-03
Fax: 33-0-1-30-39-99-03
E-mail: contact@03db.com

New Zealand

New Zealand

Adilam Electronics Pty. Ltd.

5A Tenahuan Place Sockburn
Christchurch
Tel: 64-3-341-3050
E-mail: trevor.foster@adilam.com.au

Arrow Components (NZ) Ltd. (Auckland)

Suite 3, Unit F 8 Torrens Rd Pakuranga
Tel: 64-9-622-0101
Fax: 64-9-272-2310
E-mail: martin.tompkins@arrowasia.com

Arrow Components (NZ) Ltd. (Christchurch)

Suite 3, Level 1 12-18 Moorhouse Ave
Christchurch
Tel: 64-3-366-2000
Fax: 64-3-366-2111

E-mail: gary.campbell@arrowasia.com

Arrow Components (NZ) Ltd. (Wellington)

Level 3, Crest House 92 Queens Drive
Lower Hutt
Tel: 64-4-570-2260
Fax: 64-4-566-2111

E-mail: john.hardie@arrowasia.com

Avnet NZ Ltd.

295 Cashel Street
Christchurch
New Zealand
Tel: 64-3-366-0191
Mr. Andrew Plimmer
Fax: 64-3-366-3911
E-mail: andrew.plimmer@avnet.com

Farnell Components

PO Box 74-342
Market Road
Auckland
New Zealand
Tel: 0800-90-80-80
Fax: 0800-90-80-81
E-mail: nzsales@farnell.com

Notes

Notes

Notes

Notes

Notes

Notes

CONVERSION TABLES

Wire Gauge Conversion to Decimal Equivalents*

Inch Fraction	Inch Decimal	Millimeters	Inch Fraction	Inch Decimal	Millimeters
1/64	.0156	0.397	33/64	.5156	13.097
1/32	.0312	0.794	17/32	.5312	13.494
3/64	.0468	1.191	35/64	.5468	13.891
1/16	.0625	1.588	9/16	.5625	14.288
5/64	.0781	1.984	37/64	.5781	14.684
3/32	.0937	2.381	19/32	.5937	15.081
7/64	.1093	2.778	39/64	.6093	15.478
1/8	.1250	3.175	5/8	.6250	15.875
9/64	.1406	3.572	41/64	.6406	16.272
5/32	.1562	3.969	21/32	.6562	16.669
11/64	.1718	4.366	43/64	.6718	17.066
3/16	.1875	4.763	11/16	.6875	17.463
13/64	.2031	5.159	45/64	.7031	17.859
7/32	.2187	5.556	23/32	.7187	18.256
15/64	.2343	5.954	47/64	.7343	18.653
1/4	.2500	6.350	3/4	.7500	19.050
17/64	.2656	6.747	49/64	.7656	19.447
9/32	.2812	7.144	25/32	.7812	19.844
19/64	.2968	7.541	51/64	.7968	20.241
5/16	.3125	7.938	13/16	.8125	20.638
21/64	.3281	8.334	53/64	.8281	21.034
11/32	.3437	8.731	27/32	.8437	21.431
26/64	.3593	9.128	55/64	.8593	21.828
3/8	.3750	9.525	7/8	.8750	22.225
25/64	.3906	9.922	57/64	.8906	22.622
13/32	.4062	10.319	29/32	.9062	23.019
27/64	.4218	10.716	59/64	.9218	23.416
7/16	.4375	11.113	15/16	.9375	23.813
29/64	.4531	11.509	64/64	.9531	24.209
15/32	.4687	11.906	31/32	.9687	24.606
31/64	.4843	12.303	63/64	.9843	25.003
1/2	.5000	12.700	1	1.000	25.400

Move decimal point three places to the right to read mills.
*All decimals plus or minus .003". Fractions plus or minus .055".

AWG	mm ²	Diameter		
		CMA	mm	Inches
28	0.09	175	0.33	.013
26	0.13	250	0.51	.020
24	0.22	442	0.58	.023
22	0.38	754	0.79	.031
20	0.62	1,216	0.94	.037
18	0.96	1,900	1.24	.049
16	1.23	2,426	1.47	.058
14	1.94	3,831	1.85	.073
12	3.09	6,088	2.36	.093
10	5.01	9,880	2.95	.116
8	7.96	15,700	3.73	.147
6	13.48	26,600	4.67	.184
4	21.28	42,000	5.89	.232
2	33.70	66,500	7.42	.292
1/0	52.95	104,500	9.35	.368
2/0	67.39	133,000	10.52	.414
3/0	84.72	167,200	11.79	.464
4/0	107.76	210,700	13.26	.522

Hole diameter #10 and 3/8" are available in metric reference.

#10 .190 .209 (5,31) M5
3/8" .375 .413 (10,5) M9-10

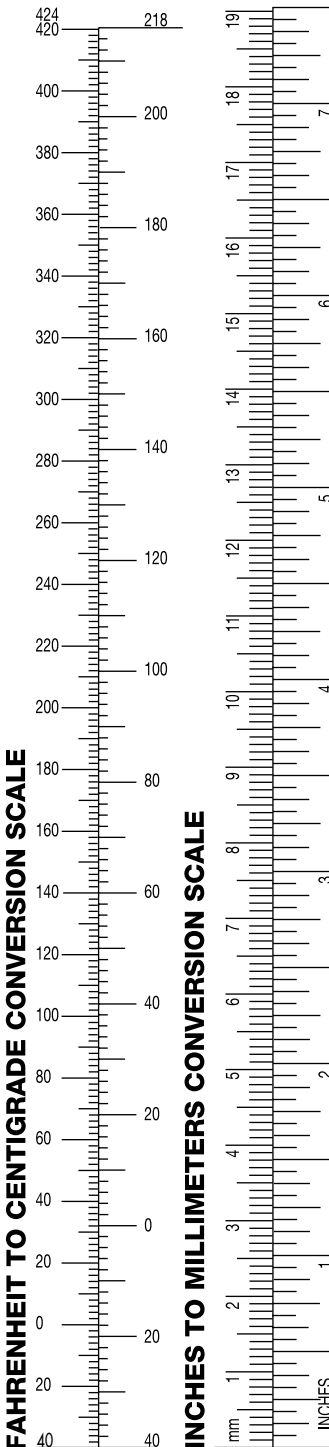

Stud size with hole sizes.

	SCREW DIA. (Inch)	HOLE DIA. Inch/mm	
●	#0	.060	M1,7-2.2
●	#1	.073	
●	#2	.086	
●	#3	.099	.120 (3,025) M2,6
●	#4	.112	
●	#5	.125	.146 (3,71) M3-3.5
●	#6	.138	
●	#8	.164	.173 (4,39) M4
●	#10	.190	.198 (5,03)
●	#12	.216	17/64 (6,75) M6
●	#14	.242	
●	1/4"	.250	
●	5/16"	.312	21/64 (8,33) M8
●	3/8"	.375	25/64 (9,92) M9
●	7/16"	.437	29/64 (11,51) M11
●	1/2"	.500	33/64 (13,10) M12
●	5/8"	.625	21/32 (16,67) M16
●	3/4"	.750	25/32 (19,84) M18
●	7/8"	.875	29/32 (23,02) M20
●	1"	1.000	1-1/32 (26,19) M25

Компания «Life Electronics» занимается поставками электронных компонентов импортного и отечественного производства от производителей и со складов крупных дистрибьюторов Европы, Америки и Азии.

С конца 2013 года компания активно расширяет линейку поставок компонентов по направлению коаксиальный кабель, кварцевые генераторы и конденсаторы (керамические, пленочные, электролитические), за счёт заключения дистрибьюторских договоров

Мы предлагаем:

- Конкуренеспособные цены и скидки постоянным клиентам.
- Специальные условия для постоянных клиентов.
- Подбор аналогов.
- Поставку компонентов в любых объемах, удовлетворяющих вашим потребностям.
- Приемлемые сроки поставки, возможна ускоренная поставка.
- Доставку товара в любую точку России и стран СНГ.
- Комплексную поставку.
- Работу по проектам и поставку образцов.
- Формирование склада под заказчика.
- Сертификаты соответствия на поставляемую продукцию (по желанию клиента).
- Тестирование поставляемой продукции.
- Поставку компонентов, требующих военную и космическую приемку.
- Входной контроль качества.
- Наличие сертификата ISO.

В составе нашей компании организован Конструкторский отдел, призванный помогать разработчикам, и инженерам.

Конструкторский отдел помогает осуществить:

- Регистрацию проекта у производителя компонентов.
- Техническую поддержку проекта.
- Защиту от снятия компонента с производства.
- Оценку стоимости проекта по компонентам.
- Изготовление тестовой платы монтаж и пусконаладочные работы.



Тел: +7 (812) 336 43 04 (многоканальный)

Email: org@lifeelectronics.ru