

$V_{CES}$	600V
$I_{C(100^{\circ}C)}$	18A
$V_{CE(sat)}$ (Typ.)	1.4V@ $I_C=30A$
$P_D$	54W

#### ●Features

- 1) Low Collector - Emitter Saturation Voltage
- 2) Soft Switching
- 3) Built in Very Fast & Soft Recovery FRD (RFN - Series)
- 4) Pb - free Lead Plating ; RoHS Compliant

#### ●Applications

- Partial Switching PFC
- Discharge Circuit
- Brake for Inverter

#### ●Outline

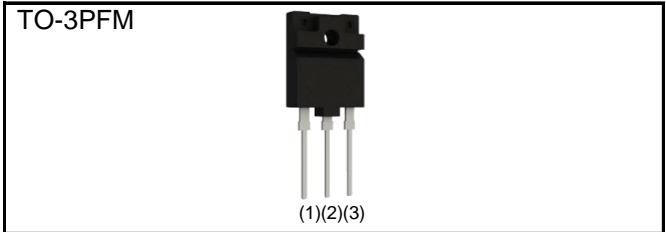

#### ●Inner Circuit



#### ●Packaging Specifications

Type	Packaging	Tube
	Reel Size (mm)	-
	Tape Width (mm)	-
	Basic Ordering Unit (pcs)	450
	Packing Code	C11
	Marking	RGCL60TK60D

#### ●Absolute Maximum Ratings (at $T_C = 25^{\circ}C$ unless otherwise specified)

Parameter	Symbol	Value	Unit	
Collector - Emitter Voltage	$V_{CES}$	600	V	
Gate - Emitter Voltage	$V_{GES}$	$\pm 30$	V	
Collector Current	$T_C = 25^{\circ}C$	$I_C$	30	A
	$T_C = 100^{\circ}C$	$I_C$	18	A
Pulsed Collector Current	$I_{CP}^{*1}$	120	A	
Diode Forward Current	$T_C = 25^{\circ}C$	$I_F$	26	A
	$T_C = 100^{\circ}C$	$I_F$	15	A
Diode Pulsed Forward Current	$I_{FP}^{*1}$	100	A	
Power Dissipation	$T_C = 25^{\circ}C$	$P_D$	54	W
	$T_C = 100^{\circ}C$	$P_D$	27	W
Operating Junction Temperature	$T_j$	-40 to +175	$^{\circ}C$	
Storage Temperature	$T_{stg}$	-55 to +175	$^{\circ}C$	

\*1 Pulse width limited by  $T_{jmax}$ .

### ●Thermal Resistance

Parameter	Symbol	Values			Unit
		Min.	Typ.	Max.	
Thermal Resistance IGBT Junction - Case	$R_{\theta(j-c)}$	-	-	2.77	°C/W
Thermal Resistance Diode Junction - Case	$R_{\theta(j-c)}$	-	-	3.93	°C/W

### ●IGBT Electrical Characteristics (at $T_j = 25^\circ\text{C}$ unless otherwise specified)

Parameter	Symbol	Conditions	Values			Unit
			Min.	Typ.	Max.	
Collector - Emitter Breakdown Voltage	$BV_{CES}$	$I_C = 10\mu\text{A}$ , $V_{GE} = 0\text{V}$	600	-	-	V
Collector Cut - off Current	$I_{CES}$	$V_{CE} = 600\text{V}$ , $V_{GE} = 0\text{V}$	-	-	10	$\mu\text{A}$
Gate - Emitter Leakage Current	$I_{GES}$	$V_{GE} = \pm 30\text{V}$ , $V_{CE} = 0\text{V}$	-	-	$\pm 200$	nA
Gate - Emitter Threshold Voltage	$V_{GE(th)}$	$V_{CE} = 5\text{V}$ , $I_C = 18.9\text{mA}$	4.5	5.5	6.5	V
Collector - Emitter Saturation Voltage	$V_{CE(sat)}$	$I_C = 30\text{A}$ , $V_{GE} = 15\text{V}$	-	1.4	1.8	V
		$T_j = 25^\circ\text{C}$	-	1.6	-	
		$T_j = 175^\circ\text{C}$	-	-	-	

●IGBT Electrical Characteristics (at  $T_j = 25^\circ\text{C}$  unless otherwise specified)

Parameter	Symbol	Conditions	Values			Unit
			Min.	Typ.	Max.	
Input Capacitance	$C_{ies}$	$V_{CE} = 30\text{V}$	-	1600	-	pF
Output Capacitance	$C_{oes}$	$V_{GE} = 0\text{V}$	-	38	-	
Reverse Transfer Capacitance	$C_{res}$	$f = 1\text{MHz}$	-	29	-	
Total Gate Charge	$Q_g$	$V_{CE} = 300\text{V}$	-	68	-	nC
Gate - Emitter Charge	$Q_{ge}$	$I_C = 30\text{A}$	-	13	-	
Gate - Collector Charge	$Q_{gc}$	$V_{GE} = 15\text{V}$	-	27	-	
Turn - on Delay Time	$t_{d(on)}$	$I_C = 30\text{A}, V_{CC} = 400\text{V}$	-	44	-	ns
Rise Time	$t_r$	$V_{GE} = 15\text{V}, R_G = 10\Omega$	-	27	-	
Turn - off Delay Time	$t_{d(off)}$	$T_j = 25^\circ\text{C}$	-	186	-	
Fall Time	$t_f$	Inductive Load	-	178	-	
Turn - on Switching Loss	$E_{on}$	* $E_{on}$ includes diode	-	0.77	-	mJ
Turn - off Switching Loss	$E_{off}$	reverse recovery	-	1.11	-	
Turn - on Delay Time	$t_{d(on)}$	$I_C = 30\text{A}, V_{CC} = 400\text{V}$	-	40	-	ns
Rise Time	$t_r$	$V_{GE} = 15\text{V}, R_G = 10\Omega$	-	45	-	
Turn - off Delay Time	$t_{d(off)}$	$T_j = 175^\circ\text{C}$	-	207	-	
Fall Time	$t_f$	Inductive Load	-	272	-	
Turn - on Switching Loss	$E_{on}$	* $E_{on}$ includes diode	-	0.97	-	mJ
Turn - off Switching Loss	$E_{off}$	reverse recovery	-	1.54	-	
Reverse Bias Safe Operating Area	RBSOA	$I_C = 120\text{A}, V_{CC} = 480\text{V}$ $V_P = 600\text{V}, V_{GE} = 15\text{V}$ $R_G = 60\Omega, T_j = 175^\circ\text{C}$	FULL SQUARE			-

**●FRD Electrical Characteristics** (at  $T_j = 25^\circ\text{C}$  unless otherwise specified)

Parameter	Symbol	Conditions	Values			Unit		
			Min.	Typ.	Max.			
Diode Forward Voltage	$V_F$	$I_F = 20\text{A}$ $T_j = 25^\circ\text{C}$ $T_j = 175^\circ\text{C}$	-	1.45	1.9	V		
			-	1.25	-			
Diode Reverse Recovery Time	$t_{rr}$	$I_F = 20\text{A}$ $V_{CC} = 400\text{V}$ $di_F/dt = 200\text{A}/\mu\text{s}$ $T_j = 25^\circ\text{C}$	-	58	-	ns		
Diode Peak Reverse Recovery Current	$I_{rr}$		-	6.3	-	A		
Diode Reverse Recovery Charge	$Q_{rr}$		-	0.20	-	$\mu\text{C}$		
Diode Reverse Recovery Energy	$E_{rr}$		-	7.4	-	$\mu\text{J}$		
Diode Reverse Recovery Time	$t_{rr}$	$I_F = 20\text{A}$ $V_{CC} = 400\text{V}$ $di_F/dt = 200\text{A}/\mu\text{s}$ $T_j = 175^\circ\text{C}$	-	256	-	ns		
			Diode Peak Reverse Recovery Current	$I_{rr}$	-	10.4	-	A
			Diode Reverse Recovery Charge	$Q_{rr}$	-	1.35	-	$\mu\text{C}$
			Diode Reverse Recovery Energy	$E_{rr}$	-	146.5	-	$\mu\text{J}$

●Electrical Characteristic Curves

Fig.1 Power Dissipation vs. Case Temperature

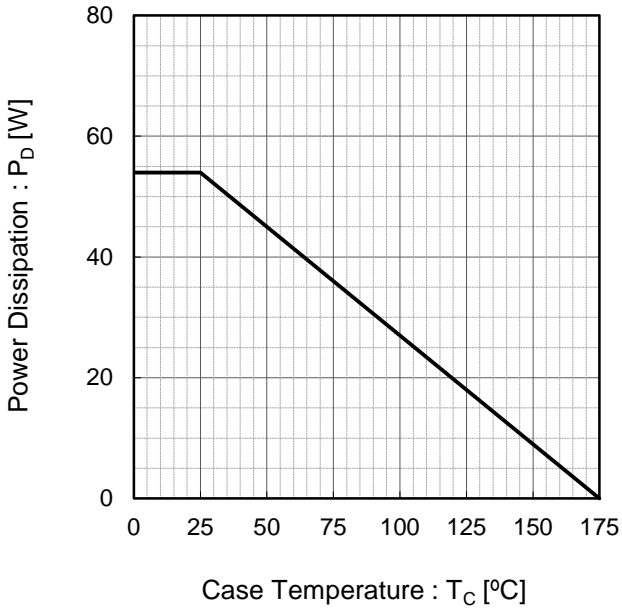

Fig.2 Collector Current vs. Case Temperature

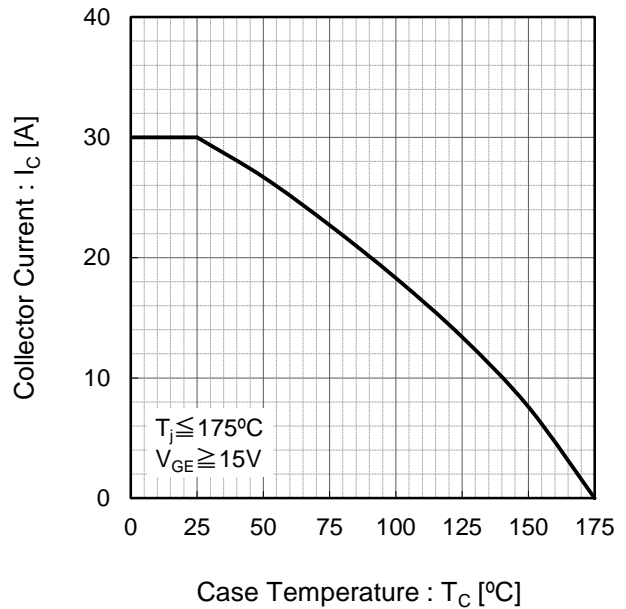

Fig.3 Forward Bias Safe Operating Area

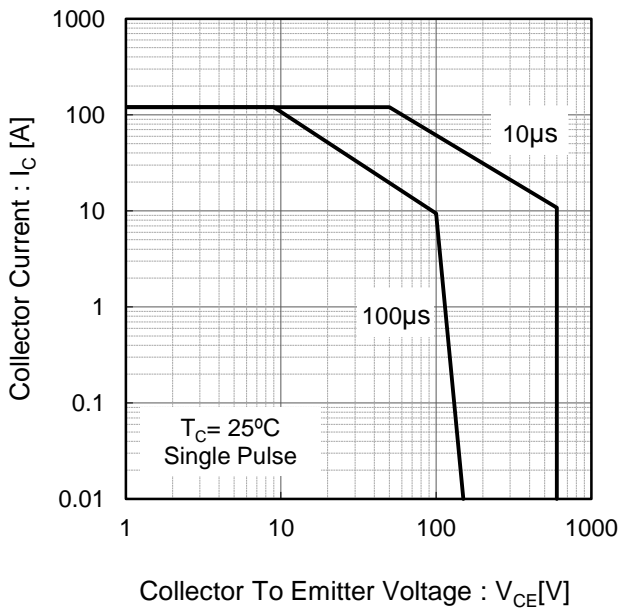
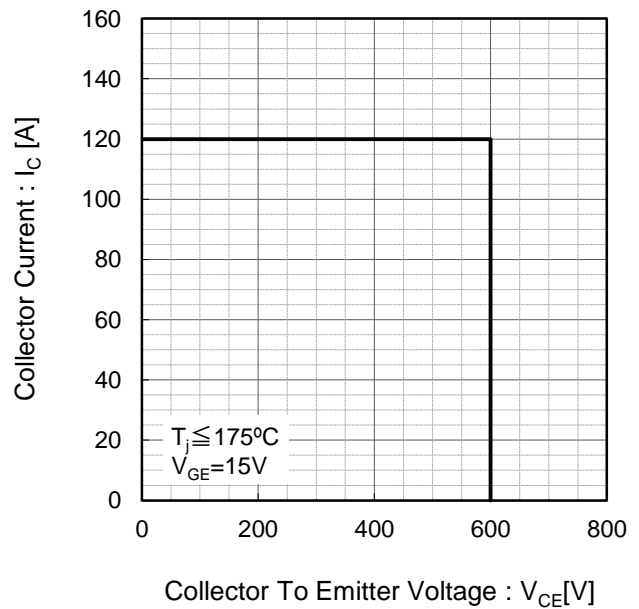

Fig.4 Reverse Bias Safe Operating Area



●Electrical Characteristic Curves

Fig.5 Typical Output Characteristics

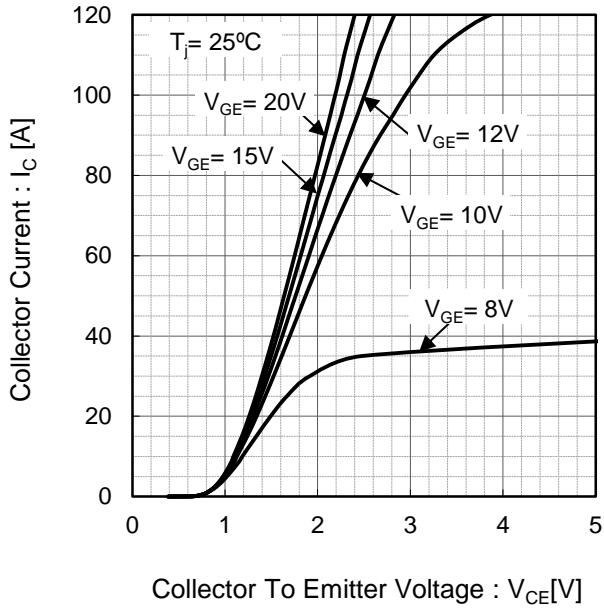

Fig.6 Typical Output Characteristics

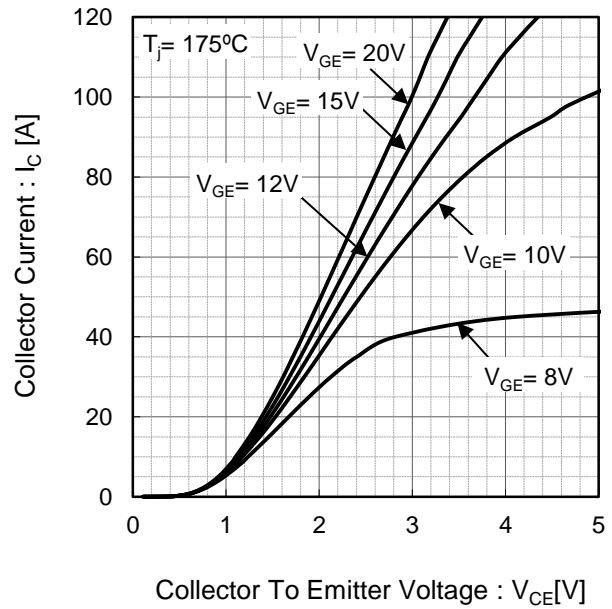

Fig.7 Typical Transfer Characteristics

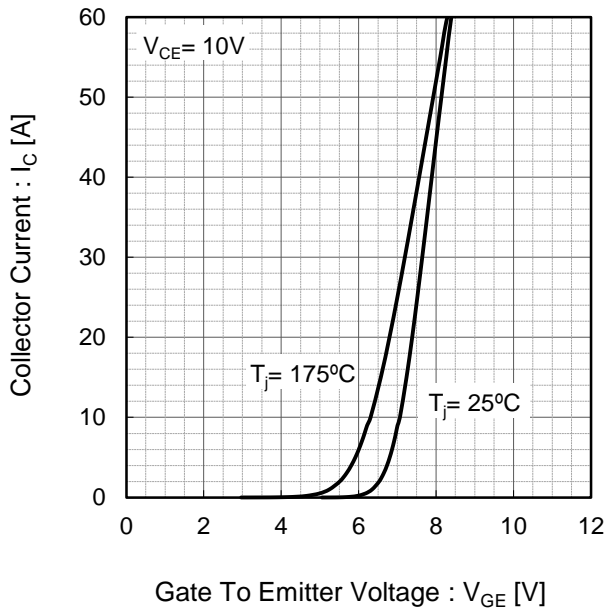
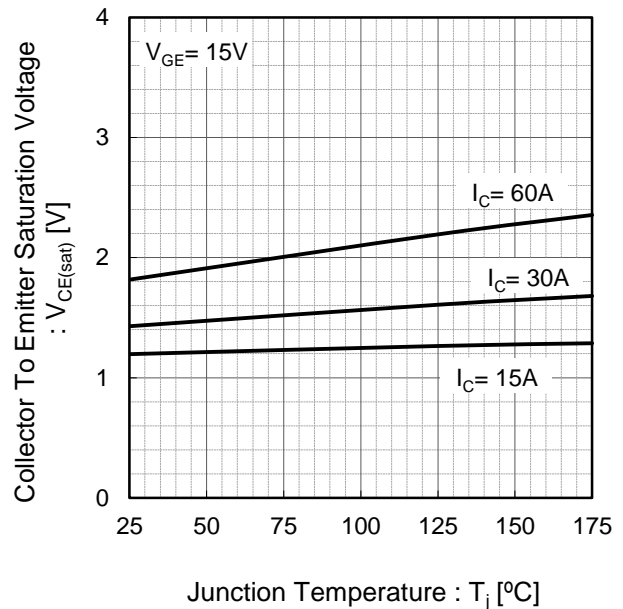

Fig.8 Typical Collector To Emitter Saturation Voltage vs. Junction Temperature



●Electrical Characteristic Curves

Fig.9 Typical Collector To Emitter Saturation Voltage vs. Gate To Emitter Voltage

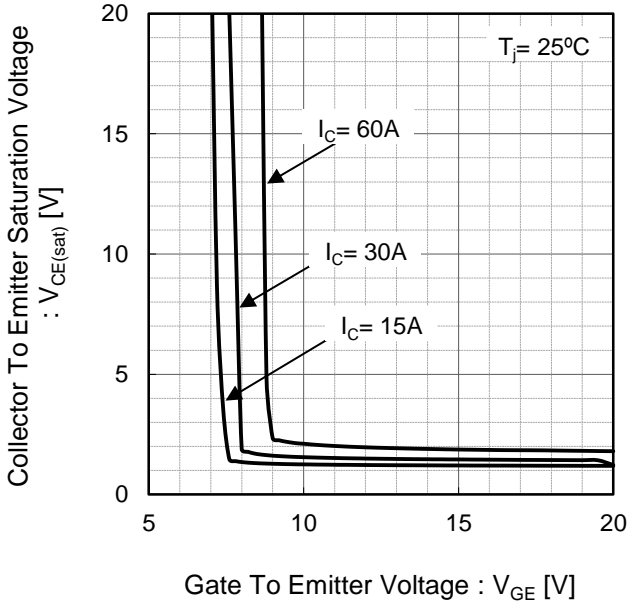

Fig.10 Typical Collector To Emitter Saturation Voltage vs. Gate To Emitter Voltage

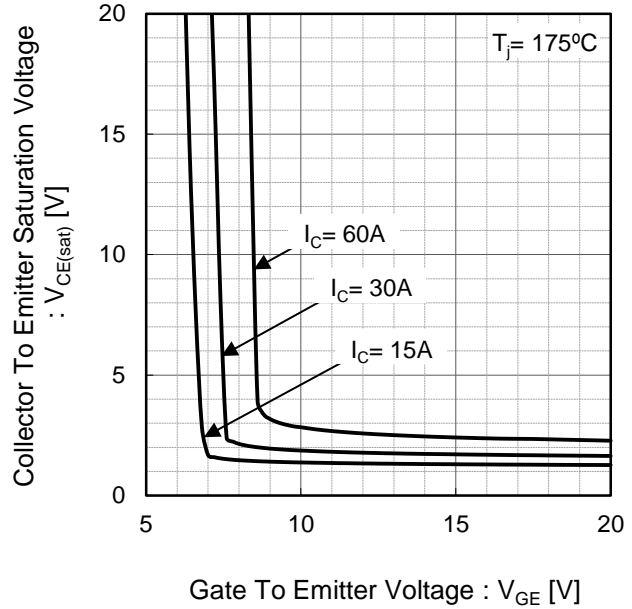

Fig.11 Typical Switching Time vs. Collector Current

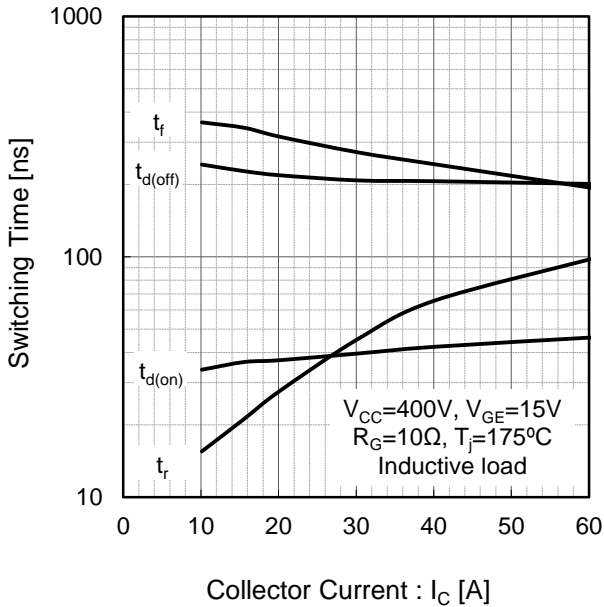
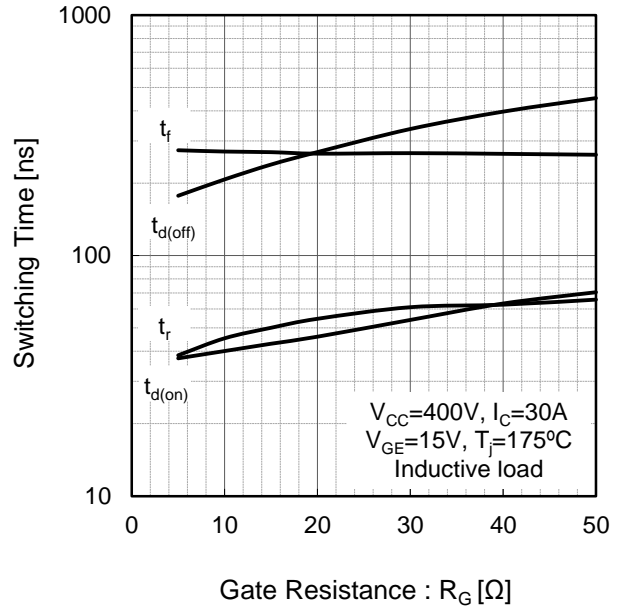

Fig.12 Typical Switching Time vs. Gate Resistance



●Electrical Characteristic Curves

Fig.13 Typical Switching Energy Losses vs. Collector Current

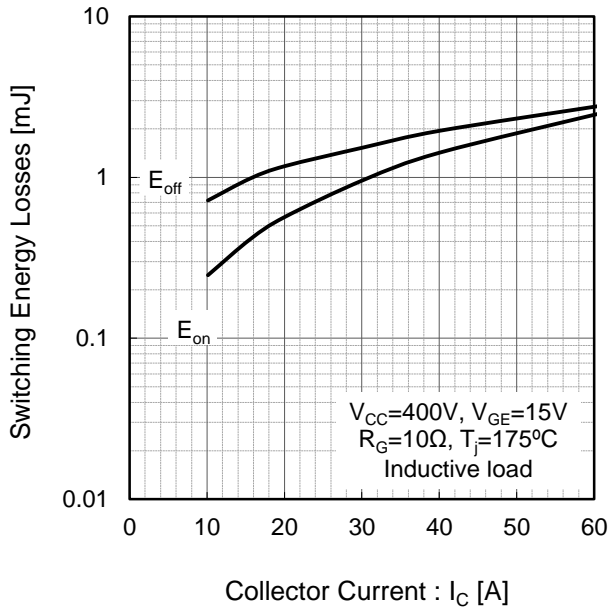

Fig.14 Typical Switching Energy Losses vs. Gate Resistance

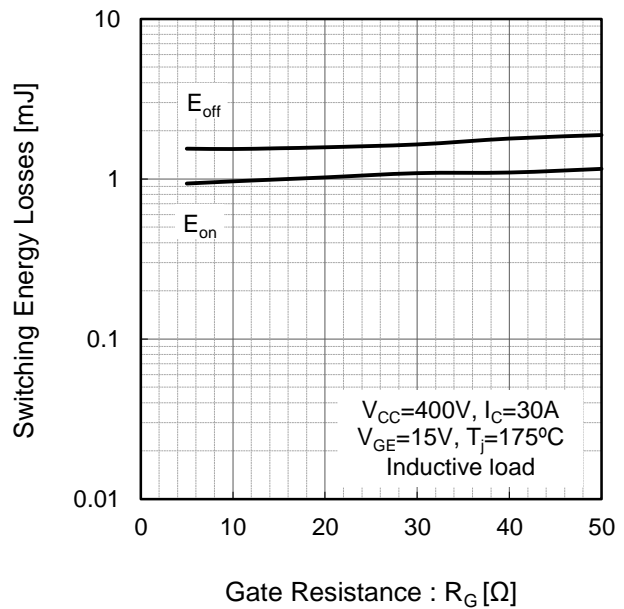

Fig.15 Typical Capacitance vs. Collector To Emitter Voltage

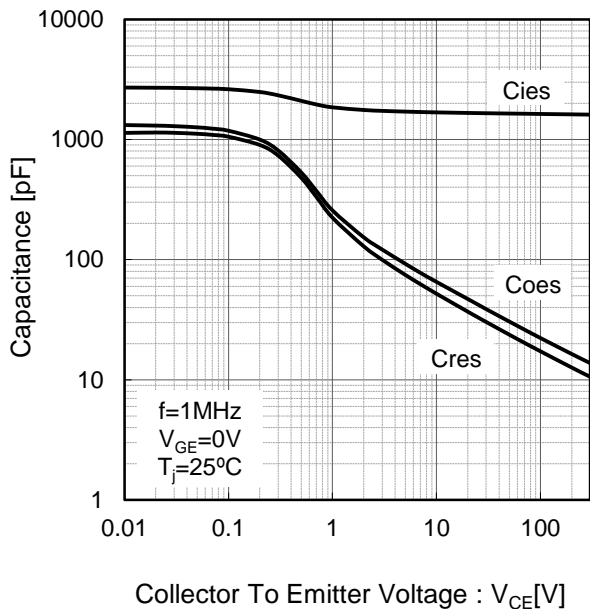
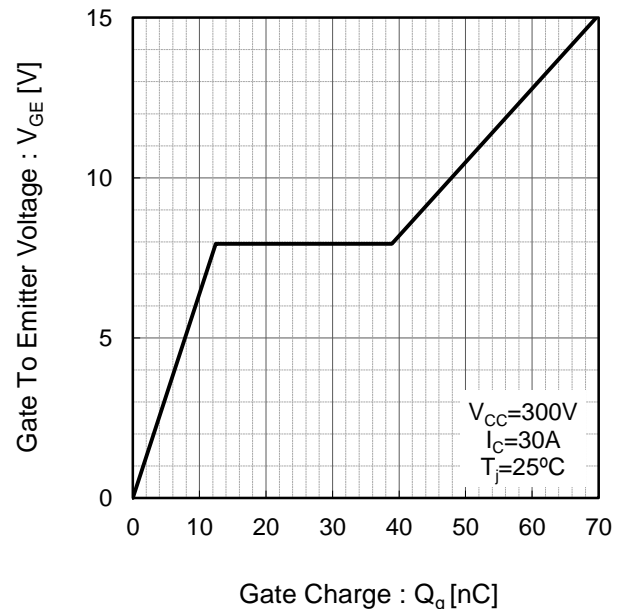

Fig.16 Typical Gate Charge





●Electrical Characteristic Curves

Fig.17 Typical Diode Forward Current vs. Forward Voltage

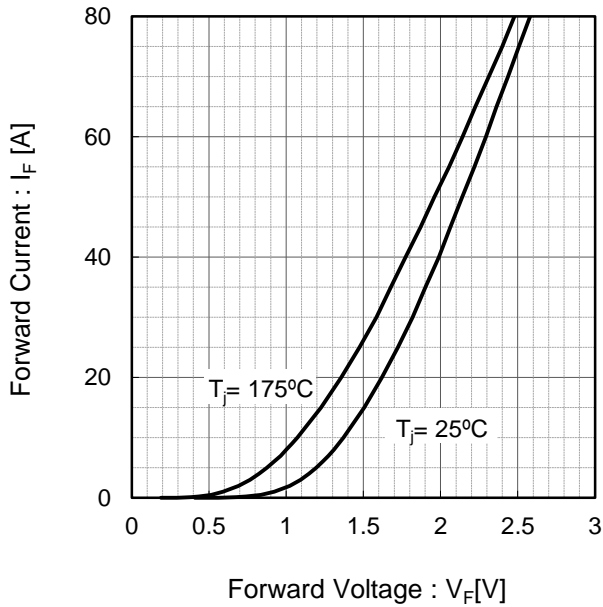

Fig.18 Typical Diode Reverse Recovery Time vs. Forward Current

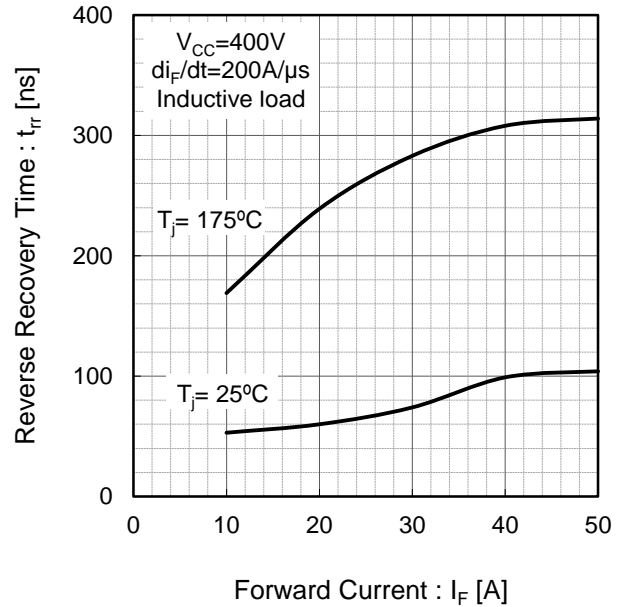

Fig.19 Typical Diode Reverse Recovery Current vs. Forward Current

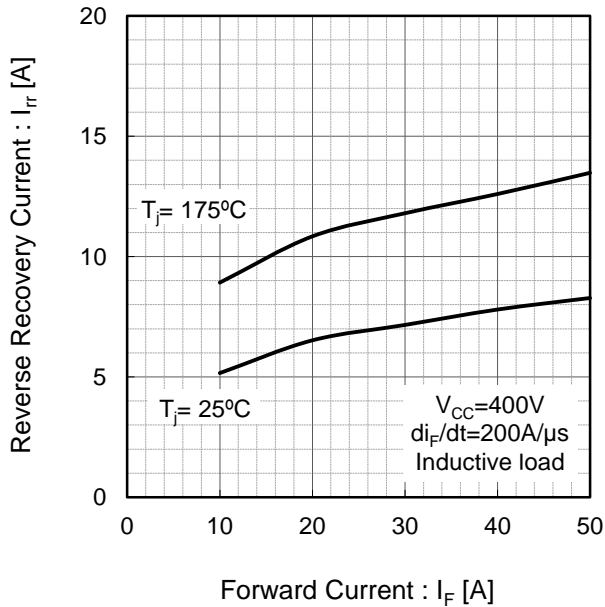
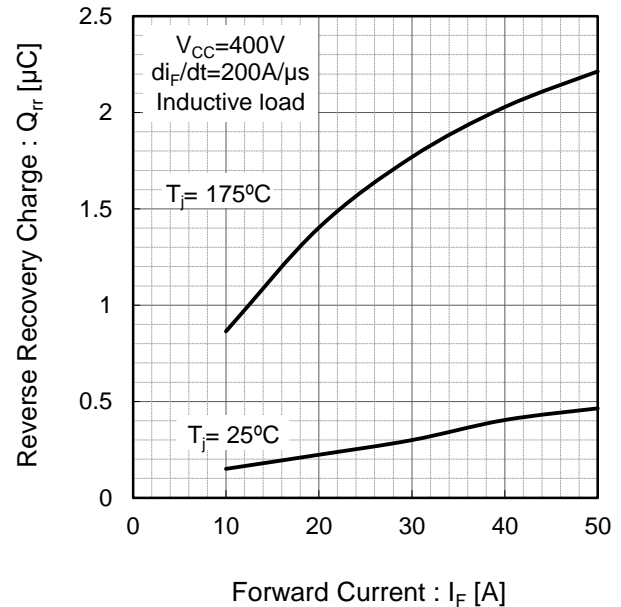

Fig.20 Typical Diode Reverse Recovery Charge vs. Forward Current



●Electrical Characteristic Curves

Fig.21 IGBT Transient Thermal Impedance

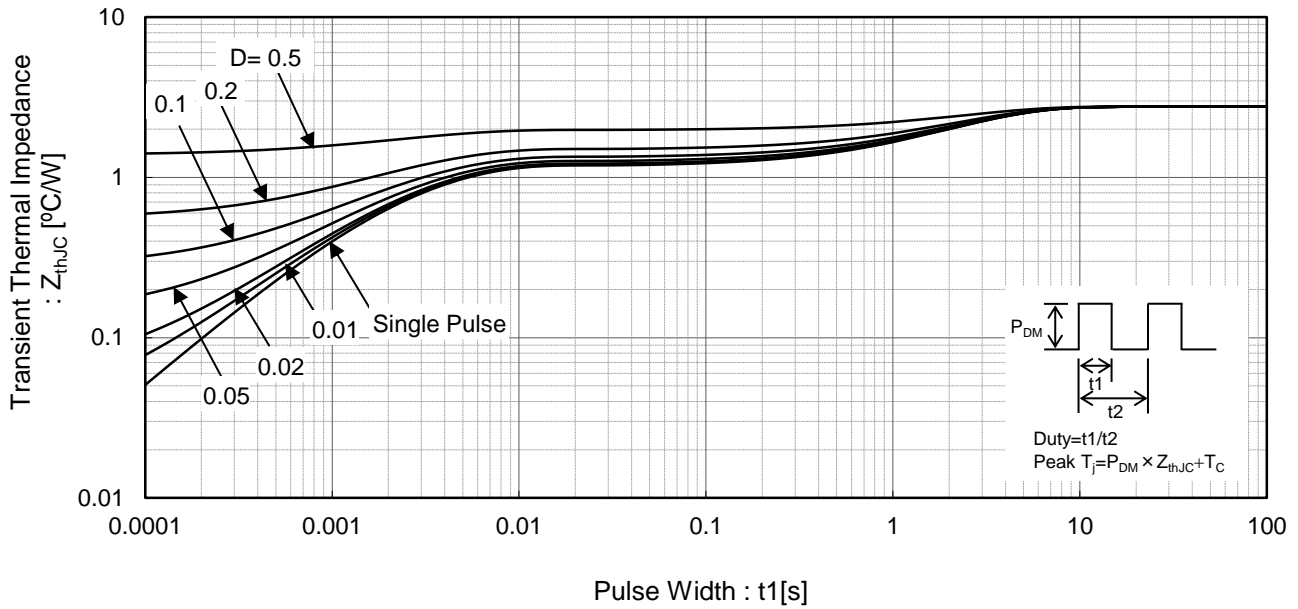
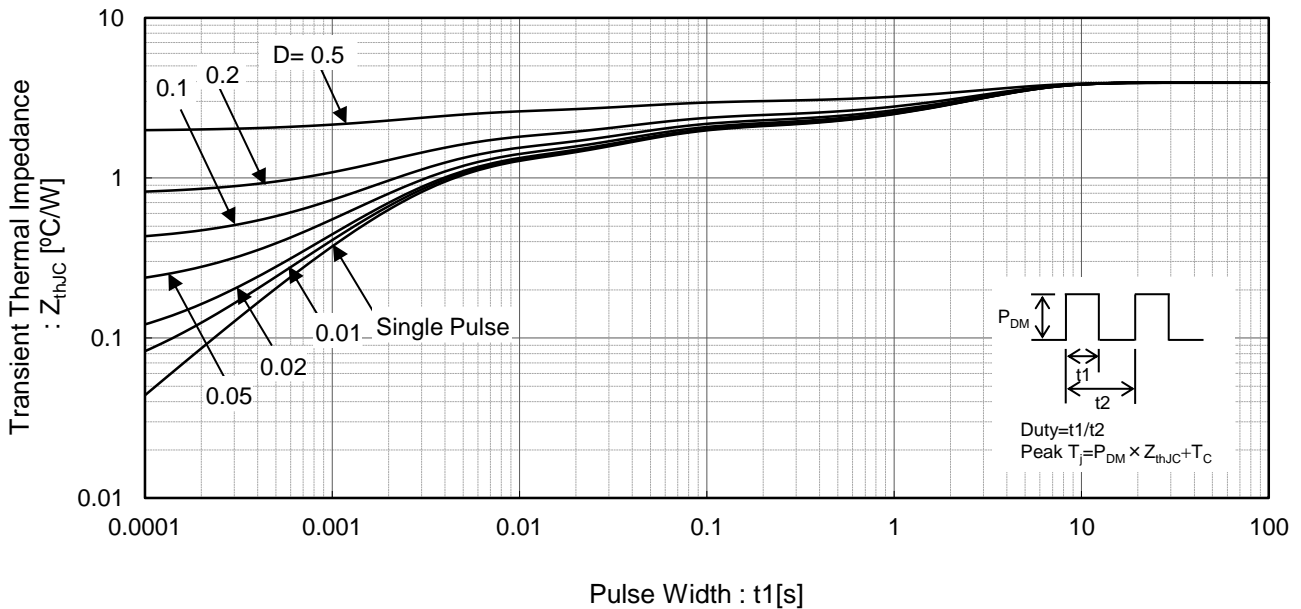

Fig.22 Diode Transient Thermal Impedance



●Inductive Load Switching Circuit and Waveform



Fig.23 Inductive Load Circuit



Fig.25 Diode Reverse Recovery Waveform

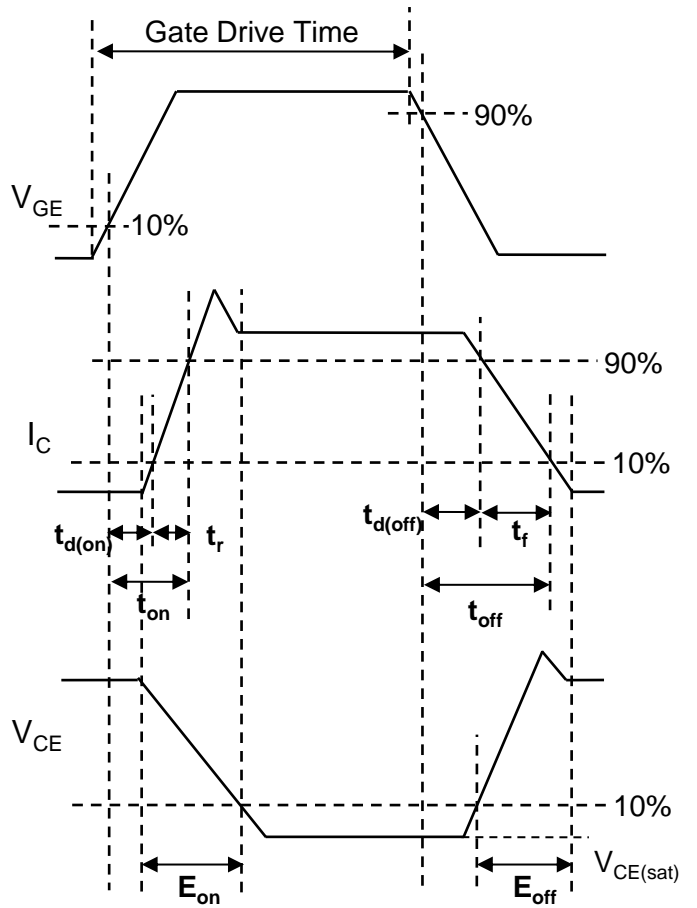

Fig.24 Inductive Load Waveform

## Notes

- 1) The information contained herein is subject to change without notice.
- 2) Before you use our Products, please contact our sales representative and verify the latest specifications :
- 3) Although ROHM is continuously working to improve product reliability and quality, semiconductors can break down and malfunction due to various factors.  
Therefore, in order to prevent personal injury or fire arising from failure, please take safety measures such as complying with the derating characteristics, implementing redundant and fire prevention designs, and utilizing backups and fail-safe procedures. ROHM shall have no responsibility for any damages arising out of the use of our Products beyond the rating specified by ROHM.
- 4) Examples of application circuits, circuit constants and any other information contained herein are provided only to illustrate the standard usage and operations of the Products. The peripheral conditions must be taken into account when designing circuits for mass production.
- 5) The technical information specified herein is intended only to show the typical functions of and examples of application circuits for the Products. ROHM does not grant you, explicitly or implicitly, any license to use or exercise intellectual property or other rights held by ROHM or any other parties. ROHM shall have no responsibility whatsoever for any dispute arising out of the use of such technical information.
- 6) The Products are intended for use in general electronic equipment (i.e. AV/OA devices, communication, consumer systems, gaming/entertainment sets) as well as the applications indicated in this document.
- 7) The Products specified in this document are not designed to be radiation tolerant.
- 8) For use of our Products in applications requiring a high degree of reliability (as exemplified below), please contact and consult with a ROHM representative : transportation equipment (i.e. cars, ships, trains), primary communication equipment, traffic lights, fire/crime prevention, safety equipment, medical systems, servers, solar cells, and power transmission systems.
- 9) Do not use our Products in applications requiring extremely high reliability, such as aerospace equipment, nuclear power control systems, and submarine repeaters.
- 10) ROHM shall have no responsibility for any damages or injury arising from non-compliance with the recommended usage conditions and specifications contained herein.
- 11) ROHM has used reasonable care to ensure the accuracy of the information contained in this document. However, ROHM does not warrants that such information is error-free, and ROHM shall have no responsibility for any damages arising from any inaccuracy or misprint of such information.
- 12) Please use the Products in accordance with any applicable environmental laws and regulations, such as the RoHS Directive. For more details, including RoHS compatibility, please contact a ROHM sales office. ROHM shall have no responsibility for any damages or losses resulting non-compliance with any applicable laws or regulations.
- 13) When providing our Products and technologies contained in this document to other countries, you must abide by the procedures and provisions stipulated in all applicable export laws and regulations, including without limitation the US Export Administration Regulations and the Foreign Exchange and Foreign Trade Act.
- 14) This document, in part or in whole, may not be reprinted or reproduced without prior consent of ROHM.



Thank you for your accessing to ROHM product informations.  
More detail product informations and catalogs are available, please contact us.

## ROHM Customer Support System

<http://www.rohm.com/contact/>

# Mouser Electronics

Authorized Distributor

Click to View Pricing, Inventory, Delivery & Lifecycle Information:

[ROHM Semiconductor:](#)

[RGCL60TK60DGC11](#)

Компания «Life Electronics» занимается поставками электронных компонентов импортного и отечественного производства от производителей и со складов крупных дистрибьюторов Европы, Америки и Азии.

С конца 2013 года компания активно расширяет линейку поставок компонентов по направлению коаксиальный кабель, кварцевые генераторы и конденсаторы (керамические, пленочные, электролитические), за счёт заключения дистрибьюторских договоров

Мы предлагаем:

- Конкурентоспособные цены и скидки постоянным клиентам.
- Специальные условия для постоянных клиентов.
- Подбор аналогов.
- Поставку компонентов в любых объемах, удовлетворяющих вашим потребностям.
- Приемлемые сроки поставки, возможна ускоренная поставка.
- Доставку товара в любую точку России и стран СНГ.
- Комплексную поставку.
- Работу по проектам и поставку образцов.
- Формирование склада под заказчика.
- Сертификаты соответствия на поставляемую продукцию (по желанию клиента).
- Тестирование поставляемой продукции.
- Поставку компонентов, требующих военную и космическую приемку.
- Входной контроль качества.
- Наличие сертификата ISO.

В составе нашей компании организован Конструкторский отдел, призванный помогать разработчикам, и инженерам.

Конструкторский отдел помогает осуществить:

- Регистрацию проекта у производителя компонентов.
- Техническую поддержку проекта.
- Защиту от снятия компонента с производства.
- Оценку стоимости проекта по компонентам.
- Изготовление тестовой платы монтаж и пусконаладочные работы.



Тел: +7 (812) 336 43 04 (многоканальный)

Email: [org@lifeelectronics.ru](mailto:org@lifeelectronics.ru)