

Illuminated Tactile Switches

B3W-9

Compact Illuminated Tactile Switch with 2 LEDs

- Compact construction (10 x 10 mm and 12 x 12 mm with 11 mm height) with bright and uniform illumination.
- Three-color illumination (red LED + green LED = orange).
- Standard force (160 gf) and high-force (230 gf) models.
- RoHS Compliant



NEW

Features

Bright and uniform illumination

- Compact construction 10 × 10 × 11 mm (W × D × H) and 12 × 12 × 11 mm (W × D × H) equipped with 2 LEDs.
- Uniquely constructed diffusion panel.

Three-color illumination

- Simultaneous use of red and green LEDs create a third color (orange).



Snap-action contact construction for a positive click action.

- Models available with two different operating forces, standard force (160 gf) and high-force (230 gf).

High contact reliability

- Sealed construction provides high contact reliability.

Model Number Structure

B3W-90□□-□□□□
1 2 3 4 5

1. Cap width

- 0: 10 x 10 mm
- 1: 12 x 12 mm

2. Operating force

- 0: Standard (OF = 160 gf)
- 2: High-force (OF = 230 gf)

3. LED color

- R: Red
- G: Green
- HG: Green (high brightness)
- Y: Yellow
- B: Blue
- RG: Red + Green (Combination of LED colors)
- RB: Red + Blue (Combination of LED colors)

4. No. of LEDs

- 1: 1
- 2: 2

5. Cap

- R: Red
- G: Green
- Y: Yellow
- B: Blue
- C: Transparent
- N: Milky white

- Note:**
1. Switches with two LEDs are only available with Transparent or Milky White caps.
 2. If a tricolour operation is required, use the Red+Green (RG) combination with the milky white cap. Simultaneous illumination of these two LEDs will produce Orange.

Ordering Information

■ 10 x 10 mm Switches

Standard force

Force	LED Colour	No. of LEDs	Cap color	Model
Standard force (OF = 160 gf)	Blue	1	Blue	B3W-9000-B1B
			Transparent	B3W-9000-B1C
			Milky white	B3W-9000-B1N
		2	Blue	B3W-9000-B2B
			Transparent	B3W-9000-B2C
			Milky white	B3W-9000-B2N
	Green	1	Green	B3W-9000-G1G
			Transparent	B3W-9000-G1C
			Milky white	B3W-9000-G1N
		2	Green	B3W-9000-G2G
			Transparent	B3W-9000-G2C
			Milky white	B3W-9000-G2N
	Green (High brightness)	1	Green	B3W-9000-HG1G
			Transparent	B3W-9000-HG1C
			Milky white	B3W-9000-HG1N
		2	Green	B3W-9000-HG2G
			Transparent	B3W-9000-HG2C
			Milky white	B3W-9000-HG2N
	Red	1	Red	B3W-9000-R1R
			Transparent	B3W-9000-R1C
			Milky white	B3W-9000-R1N
		2	Red	B3W-9000-R2R
			Transparent	B3W-9000-R2C
			Milky white	B3W-9000-R2N
Yellow	1	Yellow	B3W-9000-Y1Y	
		Transparent	B3W-9000-Y1C	
		Milky white	B3W-9000-Y1N	
	2	Yellow	B3W-9000-Y2Y	
		Transparent	B3W-9000-Y2C	
		Milky white	B3W-9000-Y2N	
Red + Blue	2	Transparent	B3W-9000-RB2C	
Red+ Green	2	Transparent	B3W-9000-RG2C	
		Milky white	B3W-9000-RG2N	
Red+High Brightness Green	2	Transparent	B3W-9000-RHG2C	

High-force

Force	LED Colour	No. of LEDs	Cap color	Model
High-force (OF = 230 gf)	Blue	1	Blue	B3W-9002-B1B
			Transparent	B3W-9002-B1C
			Milky white	B3W-9002-B1N
		2	Blue	B3W-9002-B2B
			Transparent	B3W-9002-B2C
			Milky white	B3W-9002-B2N
	Green	1	Green	B3W-9002-G1G
			Transparent	B3W-9002-G1C
			Milky white	B3W-9002-G1N
		2	Green	B3W-9002-G2G
			Transparent	B3W-9002-G2C
			Milky white	B3W-9002-G2N
	Green (High brightness)	1	Green	B3W-9002-HG1G
			Transparent	B3W-9002-HG1C
			Milky white	B3W-9002-HG1N
		2	Green	B3W-9002-HG2G
			Transparent	B3W-9002-HG2C
			Milky white	B3W-9002-HG2N
	Red	1	Red	B3W-9002-R1R
			Transparent	B3W-9002-R1C
			Milky white	B3W-9002-R1N
		2	Red	B3W-9002-R2R
			Transparent	B3W-9002-R2C
			Milky white	B3W-9002-R2N
Yellow	1	Yellow	B3W-9002-Y1Y	
		Transparent	B3W-9002-Y1C	
		Milky white	B3W-9002-Y1N	
	2	Yellow	B3W-9002-Y2Y	
		Transparent	B3W-9002-Y2C	
		Milky white	B3W-9002-Y2N	
Red + Blue	2	Transparent	B3W-9002-RB2C	
Red + Green	2	Transparent	B3W-9002-RG2C	
		Milky white	B3W-9002-RG2N	
Red+High Brightness Green	2	Transparent	B3W-9000-RHG2C	

■ 12 × 12-mm Switches

Standard force

Force	LED Colour	No. of LEDs	Cap color	Model
Standard force (OF = 160 gf)	Blue	1	Blue	B3W-9010-B1B
		1	Milky white	B3W-9010-B1N
		2	Blue	B3W-9010-B2B
		2	Milky white	B3W-9010-B2N
	Green	1	Green	B3W-9010-G1G
		1	Milky white	B3W-9010-G1N
		2	Green	B3W-9010-G2G
		2	Milky white	B3W-9010-G2N
	Green (High brightness)	1	Green	B3W-9010-HG1G
		1	Milky white	B3W-9010-HG1N
		2	Green	B3W-9010-HG2G
		2	Milky white	B3W-9010-HG2N
	Red	1	Red	B3W-9010-R1R
		1	Milky white	B3W-9010-R1N
		2	Red	B3W-9010-R2R
		2	Milky white	B3W-9010-R2N
	Yellow	1	Yellow	B3W-9010-Y1Y
		1	Milky white	B3W-9010-Y1N
		2	Yellow	B3W-9010-Y2Y
		2	Milky white	B3W-9010-Y2N
	Red+Blue	2	Milky white	B3W-9010-RB2N
	Red+Green	2	Milky white	B3W-9010-RG2N
	Red+High Brightness Green	2	Milky white	B3W-9010-RHG2N

High-force

Force	LED Colour	No. of LEDs	Cap color	Model
High-force (OF = 230 gf)	Blue	1	Blue	B3W-9012-B1B
		1	Milky white	B3W-9012-B1N
		2	Blue	B3W-9012-B2B
		2	Milky white	B3W-9012-B2N
	Green	1	Green	B3W-9012-G1G
		1	Milky white	B3W-9012-G1N
		2	Green	B3W-9012-G2G
		2	Milky white	B3W-9012-G2N
	Green (High brightness)	1	Green	B3W-9012-HG1G
		1	Milky white	B3W-9012-HG1N
		2	Green	B3W-9012-HG2G
		2	Milky white	B3W-9012-HG2N
	Red	1	Red	B3W-9012-R1R
		1	Milky white	B3W-9012-R1N
		2	Red	B3W-9012-R2R
		2	Milky white	B3W-9012-R2N
	Yellow	1	Yellow	B3W-9012-Y1Y
		1	Milky white	B3W-9012-Y1N
		2	Yellow	B3W-9012-Y2Y
		2	Milky white	B3W-9012-Y2N
	Red+Blue	2	Milky white	B3W-9012-RB2N
	Red+Green	2	Milky white	B3W-9012-RG2N
	Red+High Brightness Green	2	Milky white	B3W-9012-RHG2N

Specifications

■ Characteristics - initial (Same for Both Standard and High-force Switches)

Contact form	SPST-NO Momentary
Switching capacity	1 to 50 mA, 5 to 24 VDC (resistive load)
Contact resistance	100 mΩ max. (initial value) (rated: 1 mA, 5 VDC)
Insulation resistance	100 MΩ min. (at 250 VDC)
Dielectric strength	500 VAC, 50/60 Hz for 1 min
Bounce time	5 ms max.
Vibration resistance	Malfunction: 10 to 55 Hz, 1.5 mm double amplitude
Shock resistance	Destruction: 1,000 m/s ² (approx. 100 G) max. Malfunction: 100 m/s ² (approx. 10 G) max.
Ambient operating temperature	-25°C to 70°C (at 60% RH max.) with no icing or condensation
Ambient operating humidity	35% to 85% (at 5° to 35°C)
Life expectancy	Switch section 160 gf (standard force): 1,000,000 operations min. 230 gf (high-force): 300,000 operations min.

■ Operating Characteristics

Item	Standard-force (B3W-90□0)	High-force (B3W-90□2)
Operating force (OF) max.	160 gf	230 gf
Releasing force (RF) min.	20 gf	50 gf
Pretravel (PT)	0.25 ^{+0.2} / _{-0.1} mm	

LED Specifications

LED color	Red	Green	Green (high brightness)	Yellow	Blue
Maximum Forward current I_{FM}	27 mA	27 mA	27 mA	45 mA	27 mA
Recommended operating current I_F	20 mA	20 mA	10 mA	20 mA	10 mA
Forward voltage (typical value) V_F	1.8 V	2.1 V	3.7 V	2.4 V	3.7 V
Maximum reverse voltage V_R	5 V	5 V	5 V	5 V	5 V
Ambient operating temperature	-25°C to 70°C				

Note: For Switches with two LEDs, red and green, the recommended operating current is 12 mA for the red and 20 mA for the green LED for application with three-color illumination.

LEDs

■ Ambient Temperature vs Maximum Forward Current



■ Forward Current and Forward Voltage Curves (Condition: $T_a=25^\circ\text{C}$)

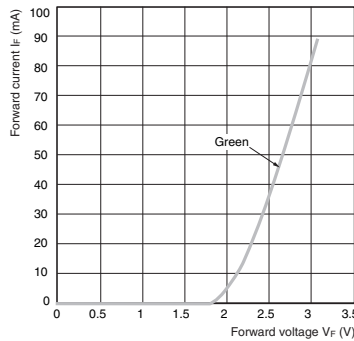
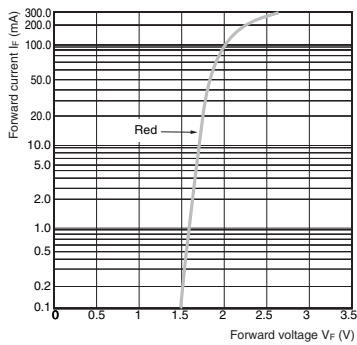

- Note:**
1. Pay attention to the polarity of each LED. The anode and cathode can be identified by finding the cathode mark, as indicated on the Dimensions page.
 2. Connect limiting resistors to the LEDs. The Switch does not have built-in limiting resistors, so satisfy the LED characteristics by obtaining the limiting resistance according to the following formula based on the voltage to be used.

$$\text{Limiting resistance (R)} = \frac{(\text{Voltage used (E)} - \text{LED forward voltage (VF)})}{\text{LED forward current (IF)}} (\Omega)$$



Dimensions

Note: Unless otherwise specified, all units are in millimeters and a tolerance of ± 0.4 mm applies to all dimensions.

1 LED Types

B3W-900□-□1□

B3W-901□-□1□



PCB Mounting (Top View)



Terminal Arrangement/ Internal Connections (Top View)



Note: If the poles of the LED are set into it may result in malfunction.

Note: Terminal numbers are not printed on the Switch itself.

2 LED Types

B3W-900□-□2□

B3W-901□-□2□

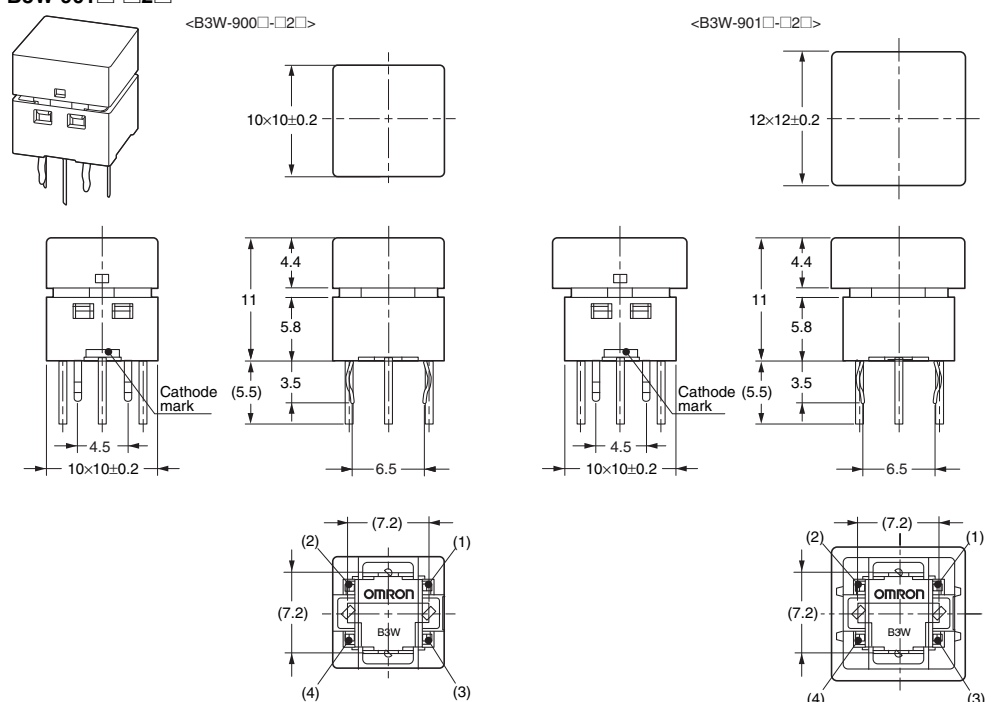

PCB Mounting (Top View)

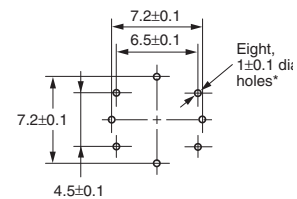

Terminal Arrangement/ Internal Connections (Top View)

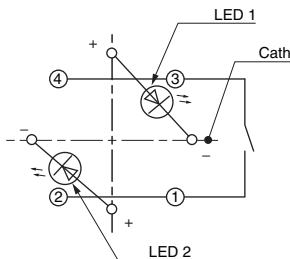

Note 1: If the poles of the LED are set into it may result in malfunction.
 2: For models with two-color LEDs, th of LED 1 is at position LED 1. The color of LED 2 is at the position B3W-90□-□-□RG2□

Note: Terminal numbers are not printed on the Switch itself.

Accessories - Text Combination Films for B3W-9

Text Combination Films for B3W-9 Illuminated Tactile Switches

- Display two different labels in combination with a single 2-LED B3W-9 Switch.
- Color combinations: Red/Green or Red/Blue



Model Number Structure

B3W-9 - **F**

1 2 3

1. Color

R: Red

2. Color

B: Blue

G: Green

3. Color and text combination

F1: Red OFF
 Blue or green ON

F4: Red ×
 Blue or green ○

F5: Red ▼
 Blue or green ▲

Note: 1. Three 'text combinations' are available.

2. Films can also be customized with other text for 50 sheets (1,250 films) per lot. Delivery time is approximately five weeks. (Ask your OMRON representative for details.)

Text Combinations	LED colors	Model
"OFF" and "ON"	Red/Blue	B3W-9RB-F1
	Red/Green	B3W-9RG-F1
"×" and "○"	Red/Blue	B3W-9RB-F4
	Red/Green	B3W-9RG-F4
"▼" and "▲"	Red/Blue	B3W-9RB-F5
	Red/Green	B3W-9RG-F5

Note: Minimum Order = 25 films/sheet (B3W-9 Films are sold in units of 25 films. Orders must be made in multiples of 25, the quantity per sheet.)

Recommended B3W-9 Switches

Note: Use the following 2 LED versions of the B3W-9's with the above mentioned films for best results

Operating force	2-LED Switches	Red/Blue	Red/Bright green
Standard-force Switches		B3W-9000-RB2C	B3W-9000-RHG2C
High-force Switches		B3W-9002-RB2C	B3W-9002-RHG2C

Note: Text Combination Films are sold without the Switches. Order one of the above models of B3W-9 Illuminated Tactile Switches separately.

Safety Precautions

■ Precautions for Correct Use

Electrical Standards

All Use the Switch within the rated voltage and current ranges, otherwise the Switch may have a shortened life expectancy, radiate heat, or burn out. This particularly applies to the instantaneous voltages and currents when switching.

Soldering

1. Soldering Precautions

- Before any kind of soldering, test to confirm that soldering can be performed properly. Otherwise the Switch may be deformed by the soldering heat depending on the type of PCB, pattern, or lands of the PCB.
- Do not solder the Switch more than twice, including rectification soldering. Wait for at least five minutes between the first and second soldering to allow the temperature to return to normal. Continuous soldering may cause the casing to melt or deteriorate the Switch characteristics.

2. Automatic Soldering Baths (Wave Soldering)

- Soldering temperature: 260°C max.
- Soldering time: 5 s max. for a 1.6-mm thick single-side PCB
- Preheating temperature: 100°C max. (ambient temperature)
- Preheating time: Within 60 s
- Precautions
Make sure that no flux will rise above the level of the PCB. Also make sure that flux is not applied to the switch terminals or to the mounting surface of the PCB. If flux overflows onto the mounting surface of the PCB, it may enter the Switch and cause a malfunction.

3. Manual Soldering

- Soldering temperature: 350°C max. at the tip of the soldering iron
- Soldering time: 3 s max. for a 1.6-mm thick, single-side PCB
- Precautions: Before soldering the Switch on a PCB, make sure that there is no unnecessary space between the Switch and the PCB.

Washing

Since Illumination part and actuation part are not sealed, switch cannot be washed. Doing so will cause the washing agent, together with flux or dust particles on the PCB, to enter the Switch, resulting in malfunction.

PCBs

The Switch is designed for a 1.6-mm thick, single-side PCB. Using PCBs with a different thickness or using double-sided, through-hole PCBs may result in loose mounting, improper insertion, or poor heat resistance in soldering. These effects will occur, depending on the type of holes and patterns of the PCB.

Therefore, it is recommended that a verification test is conducted

Handling

1. Usage Environment

Before installing the Switch, make sure that the area of installation is not subject to corrosive gases emitted from surrounding parts.

Do not use in areas subject to high temperatures, high humidity, or toxic gases such as sulfuric gas (H₂S, SO₂), ammonia gas (NH₃), nitric gas (HNO₃), or chlorine gas (Cl₂). It can cause

corrosive damage to the contacts and result in malfunction. If there is silicon in the atmosphere, it may stop the contacts from functioning properly.

If silicon products, such as silicon oil, silicon filler, or silicon wires, are used in the surrounding area, install a contact protection circuit to prevent arching or remove the silicon source.

The following situations may cause water to enter inside the Switch, resulting in a malfunction due to contact failure or corrosion.

- Using the Switch in an outdoor environment where it is exposed to water drops for an extended period of time.
- Using the Switch in an underwater setting where it is subject to strong water pressure.

Do not use Switches that have been dropped. The mating section or other internal parts may be damaged, resulting in malfunction.

Operation

Do not repeatedly operate the Switch with excessive force. Applying excessive pressure or applying additional force after the plunger has stopped may deform the disk spring of the Switch, resulting in malfunction.

Be sure to set up the Switch so that the plunger will operate in a straight vertical line.

If the plunger is pressed off-center or from an angle it may cause deformation or damage to some parts. This may result in deterioration of durability or malfunction.

Removing the Cap - Text Film Installation

1. Hold the cap at the side away from the mating section. Pull straight up.
2. Do not remove the cap while the Switch is mounted. Doing so will apply force to the soldered section and LEDs, resulting in malfunction.

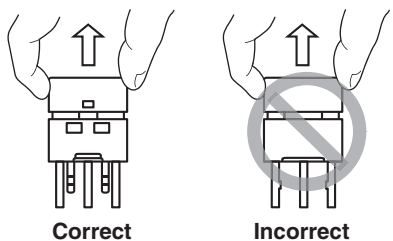

Placing the Cap on the Switch

Hold the Cap at the side away from the mating section. Push straight down until the mating section meets.

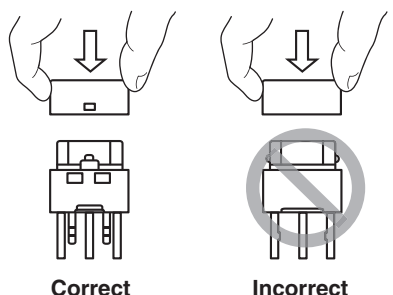

Removing the Cap

The Cap can be removed up to two times. Excessively removing the Cap will cause the mating section to become weak, resulting the operating section not mating completely or the Cap may fall off.

Film Dimensions

Dimensions of the film are shown below. The thickness is 0.2 mm.

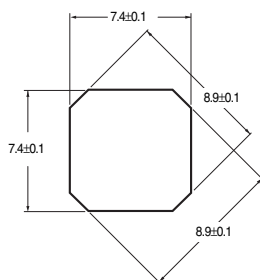

Dust Protection

Although the switching mechanism is a sealed structure (IP64), illumination part and actuation part is not sealed. Ensure you have the correct environmental conditions for installation. Use a protective sheet or take other measures to protect against dust.

Sensitivity to Static Electricity

Switches with high-brightness green (HG) or blue (B) LEDs are susceptible to static electricity. Take care when handling switches with these LEDs as the LEDs may be damaged.

Storage Precautions

Storage Environment

To prevent degradation, such as discoloration, of the terminals during storage, do not store the Switch in locations that are subject to the following conditions.

1. High temperature or humidity
2. Corrosive gases
3. Direct sunlight

Storage condition

Store the Switches in the packaging box.

After the packaging box is opened, use the contents as quickly as possible. When storing leftover parts, make sure that appropriate measures are taken against humidity and corrosive gases.

Agreement of Product Use

Comply with the usage, storage, and disposal conditions specified by OMRON as outlined in the precautions in the product datasheet and specifications.

Be sure to read the precautions common to all Tactile Switches, contained in the Technical User's Guide, "Tactile Switches, Technical Information" for correct use



All sales are subject to Omron Electronic Components LLC standard terms and conditions of sale, which can be found at http://www.components.omron.com/components/web/webfiles.nsf/sales_terms.html

ALL DIMENSIONS SHOWN ARE IN MILLIMETERS.

To convert millimeters into inches, multiply by 0.03937. To convert grams into ounces, multiply by 0.03527.

OMRON[®]

**OMRON ELECTRONIC
COMPONENTS LLC**

55 E. Commerce Drive, Suite B
Schaumburg, IL 60173

847-882-2288

OMRON ON-LINE

Global - <http://www.omron.com>

USA - <http://www.components.omron.com>

Компания «Life Electronics» занимается поставками электронных компонентов импортного и отечественного производства от производителей и со складов крупных дистрибьюторов Европы, Америки и Азии.

С конца 2013 года компания активно расширяет линейку поставок компонентов по направлению коаксиальный кабель, кварцевые генераторы и конденсаторы (керамические, пленочные, электролитические), за счёт заключения дистрибьюторских договоров

Мы предлагаем:

- Конкурентоспособные цены и скидки постоянным клиентам.
- Специальные условия для постоянных клиентов.
- Подбор аналогов.
- Поставку компонентов в любых объемах, удовлетворяющих вашим потребностям.
- Приемлемые сроки поставки, возможна ускоренная поставка.
- Доставку товара в любую точку России и стран СНГ.
- Комплексную поставку.
- Работу по проектам и поставку образцов.
- Формирование склада под заказчика.
- Сертификаты соответствия на поставляемую продукцию (по желанию клиента).
- Тестирование поставляемой продукции.
- Поставку компонентов, требующих военную и космическую приемку.
- Входной контроль качества.
- Наличие сертификата ISO.

В составе нашей компании организован Конструкторский отдел, призванный помогать разработчикам, и инженерам.

Конструкторский отдел помогает осуществить:

- Регистрацию проекта у производителя компонентов.
- Техническую поддержку проекта.
- Защиту от снятия компонента с производства.
- Оценку стоимости проекта по компонентам.
- Изготовление тестовой платы монтаж и пусконаладочные работы.



Тел: +7 (812) 336 43 04 (многоканальный)

Email: org@lifeelectronics.ru