

## Dual Photovoltaic MOSFET Driver Solid State Relay

### Features

- High Open Circuit Voltage
- High Short Circuit Current
- Isolation Test Voltage 5300 V<sub>RMS</sub>
- Logic Compatible Input
- High Reliability
- Lead-free component
- Component in accordance to RoHS 2002/95/EC and WEEE 2002/96/EC

DIP

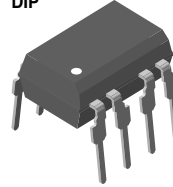

SMD

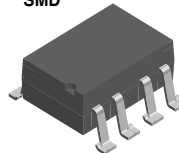

1179020

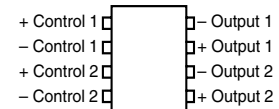
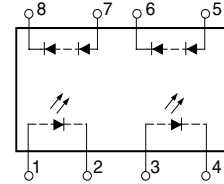

### Agency Approvals

- UL1577, File No. E52744 System Code H or J, Double Protection
- BSI/BABT Cert. No. 7980
- DIN EN 60747-5-2 (VDE0884)  
DIN EN 60747-5-5 pending
- FIMKO Approval

### Applications

- High-side Driver
- Solid State Relays
- Floating Power Supply
- Power Control
- Data Acquisition
- ATE
- Isolated Switching
- See "Solid State Relays" (Application Note 56)

### Description

The LH1262CB/CAC Photovoltaic MOSFET Driver consists of two LEDs optically coupled to two photodiode arrays. The photodiode array provides a floating source with adequate voltage and current to drive high-power MOSFET transistors. Optical coupling provides a high I/O Isolation voltage. In order to turn the MOSFET off, an external resistance (gate-to-source) is required for gate discharge.

### Order Information

Part	Remarks
LH1262CAC	Tubes, SMD-8
LH1262CACTR	Tape and Reel, SMD-8
LH1262CB	Tubes, DIP-8

## Absolute Maximum Ratings, $T_{amb} = 25\text{ }^{\circ}\text{C}$

Stresses in excess of the absolute Maximum Ratings can cause permanent damage to the device. Functional operation of the device is not implied at these or any other conditions in excess of those given in the operational sections of this document. Exposure to absolute Maximum Ratings for extended periods of time can adversely affect reliability.

## SSR

Parameter	Test condition	Symbol	Value	Unit
LED input ratings continuous forward current		$I_F$	50	mA
LED input ratings reverse voltage	$I_R \leq 10\text{ }\mu\text{A}$	$V_R$	5.0	V
Photodiode array reverse voltage	$I_R \leq 2.0\text{ }\mu\text{A}$	$V_R$	100	V
Ambient operating temperature range		$T_{amb}$	- 40 to + 100	$^{\circ}\text{C}$
Storage temperature range		$T_{stg}$	- 40 to + 150	$^{\circ}\text{C}$
Pin soldering time	$t = 7.0\text{ s max.}$	$T_S$	270	$^{\circ}\text{C}$
Input/output isolation voltage	$t = 60\text{ s min.}$	$V_{ISO}$	5300	$V_{RMS}$

## Electrical Characteristics, $T_{amb} = 25\text{ }^{\circ}\text{C}$

Minimum and maximum values are testing requirements. Typical values are characteristics of the device and are the result of engineering evaluations. Typical values are for information only and are not part of the testing requirements.

Parameter	Test condition	Symbol	Min	Typ.	Max	Unit
LED forward voltage	$I_F = 10\text{ mA}$	$V_F$	1.15	1.26	1.45	V
Detector forward voltage	$I_F = 10\text{ }\mu\text{A}$	$V_{F(PDA)}$		14		V
Detector reverse voltage	$I_R = 2.0\text{ }\mu\text{A}$	$V_{R(PDA)}$		200		V
Open circuit voltage (pins 5, 6 or 7, 8)	$I_F = 5.0\text{ mA}$	$V_{OC}$	10	12	15	V
	$I_F = 10\text{ mA}$	$V_{OC}$		13.1		V
	$I_F = 20\text{ mA}$	$V_{OC}$		13.3		V
Short circuit current (pins 5, 6 or 7, 8)	$I_F = 5.0\text{ mA}$	$I_{SC}$	1.0	2.44	6.5	$\mu\text{A}$
	$I_F = 10\text{ mA}$	$I_{SC}$	2.6	5.24	14	$\mu\text{A}$
	$I_F = 20\text{ mA}$	$I_{SC}$		10.8		$\mu\text{A}$
Turn-on time	$I_F = 20\text{ mA}^{1)}$	$t_{on}$		35		$\mu\text{s}$
Turn-off time	$I_F = 20\text{ mA}^{1)}$	$t_{off}$		90		$\mu\text{s}$

<sup>1)</sup>  $f = 1.0\text{ kHz}$ , pulse width =  $100\text{ }\mu\text{s}$ , load ( $R_L$ ) =  $1.0\text{ M}\Omega$ ,  $15\text{ pF}$ ; measured at 90 % rated voltage ( $t_{on}$ ), 10 % rated voltage ( $t_{off}$ ). Actuation speed depends upon the external  $t_{on}$  and  $t_{off}$  circuitry and the capacitance of the MOSFET.

## Functional Description

Figure 1 outlines the IV characteristics of the illuminated photodiode array (PDA). For operation at voltages below  $V_{OC}$ , the PDA acts as a nearly constant current source. The actual region of operation depends upon the load.

The amount of current applied to the LED (pins 1 and 2 or 3 and 4) determines the amount of light produced for the PDA. For high temperature operation, more LED current may be required.

## Typical Characteristics (Tamb = 25 °C unless otherwise specified)

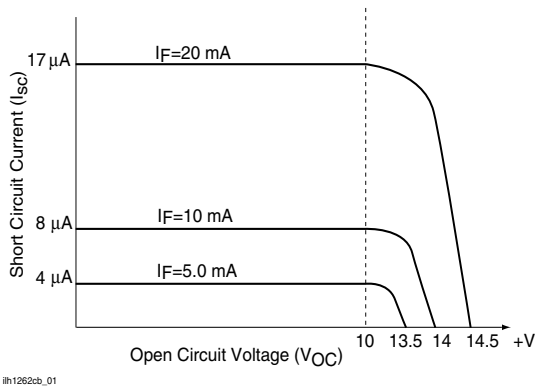

Figure 1. Typical PDA ON Characteristics

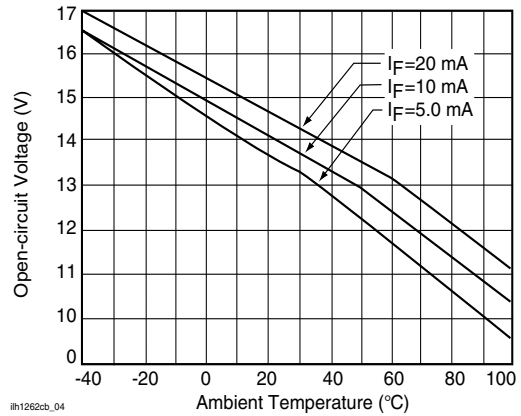

Figure 4. Typical PDA ON Characteristics

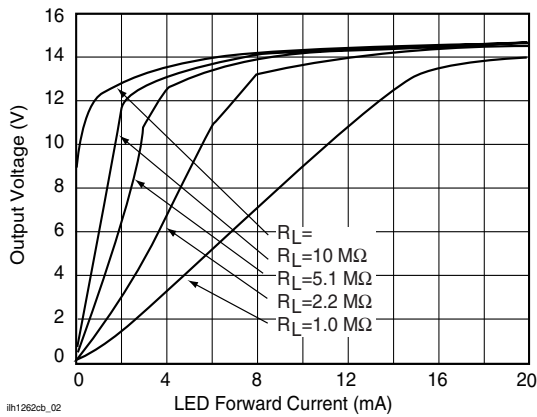

Figure 2. Typical PDA ON Characteristics

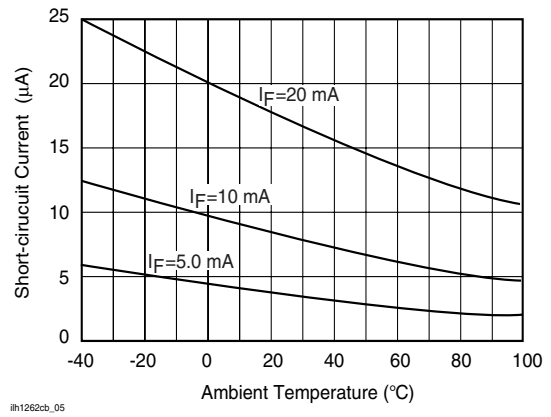

Figure 5. Typical PDA ON Characteristics

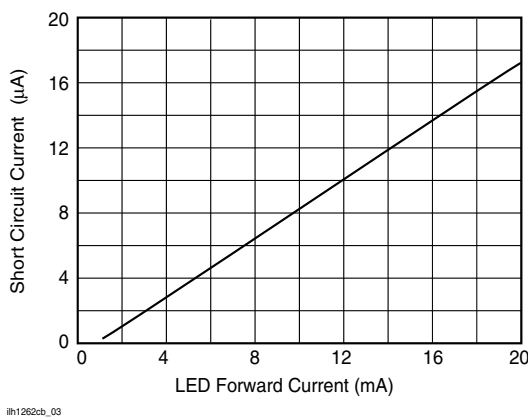

Figure 3. Typical PDA ON Characteristics

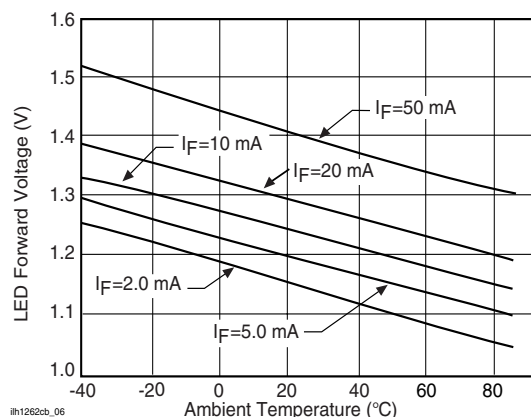

Figure 6. Typical PDA ON Characteristics

Figure 7. Typical PDA ON Characteristics

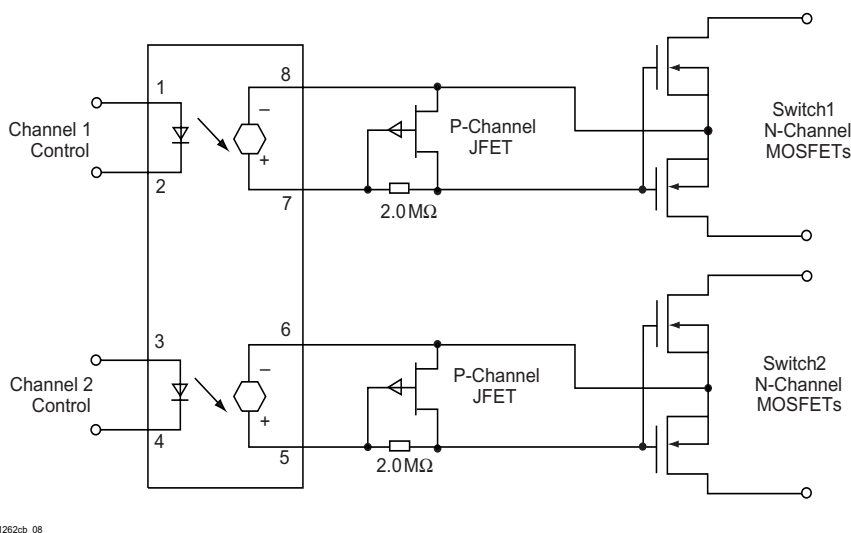
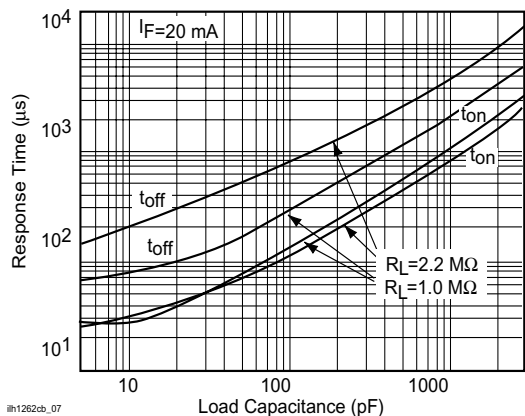
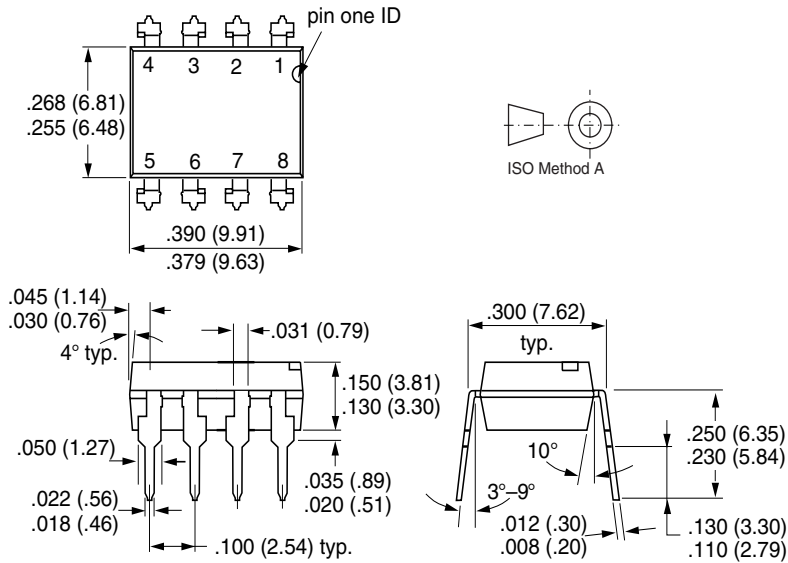

Figure 8. Typical Dual Form A Solid State Relay Application

## Package Dimensions in Inches (mm)

### DIP



i178008

## Package Dimensions in Inches (mm)

### SMD

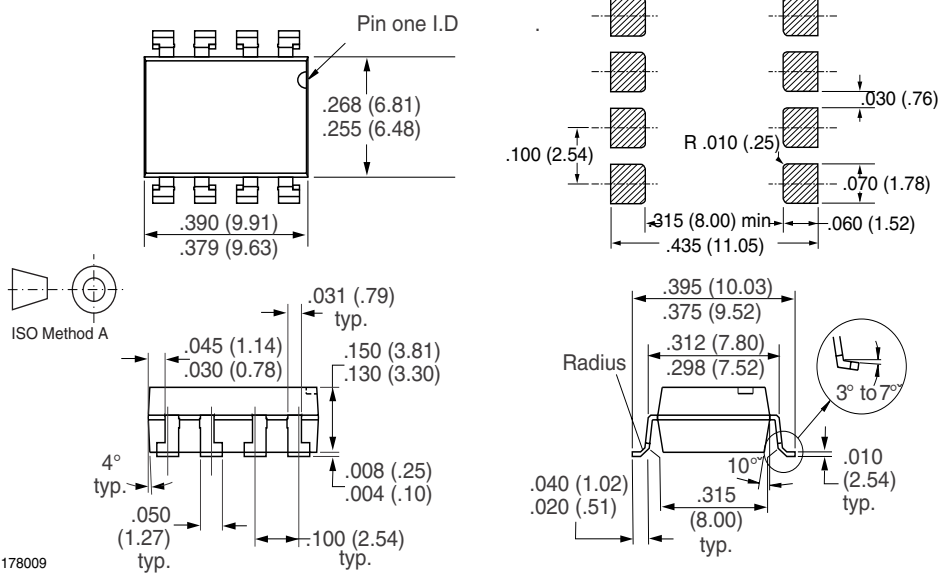

i178009

### Ozone Depleting Substances Policy Statement

It is the policy of Vishay Semiconductor GmbH to

1. Meet all present and future national and international statutory requirements.
2. Regularly and continuously improve the performance of our products, processes, distribution and operating systems with respect to their impact on the health and safety of our employees and the public, as well as their impact on the environment.

It is particular concern to control or eliminate releases of those substances into the atmosphere which are known as ozone depleting substances (ODSs).

The Montreal Protocol (1987) and its London Amendments (1990) intend to severely restrict the use of ODSs and forbid their use within the next ten years. Various national and international initiatives are pressing for an earlier ban on these substances.

Vishay Semiconductor GmbH has been able to use its policy of continuous improvements to eliminate the use of ODSs listed in the following documents.

1. Annex A, B and list of transitional substances of the Montreal Protocol and the London Amendments respectively
2. Class I and II ozone depleting substances in the Clean Air Act Amendments of 1990 by the Environmental Protection Agency (EPA) in the USA
3. Council Decision 88/540/EEC and 91/690/EEC Annex A, B and C (transitional substances) respectively.

Vishay Semiconductor GmbH can certify that our semiconductors are not manufactured with ozone depleting substances and do not contain such substances.

We reserve the right to make changes to improve technical design  
and may do so without further notice.

Parameters can vary in different applications. All operating parameters must be validated for each customer application by the customer. Should the buyer use Vishay Semiconductors products for any unintended or unauthorized application, the buyer shall indemnify Vishay Semiconductors against all claims, costs, damages, and expenses, arising out of, directly or indirectly, any claim of personal damage, injury or death associated with such unintended or unauthorized use.

Vishay Semiconductor GmbH, P.O.B. 3535, D-74025 Heilbronn, Germany  
Telephone: 49 (0)7131 67 2831, Fax number: 49 (0)7131 67 2423

Компания «Life Electronics» занимается поставками электронных компонентов импортного и отечественного производства от производителей и со складов крупных дистрибьюторов Европы, Америки и Азии.

С конца 2013 года компания активно расширяет линейку поставок компонентов по направлению коаксиальный кабель, кварцевые генераторы и конденсаторы (керамические, пленочные, электролитические), за счёт заключения дистрибьюторских договоров

Мы предлагаем:

- Конкурентоспособные цены и скидки постоянным клиентам.
- Специальные условия для постоянных клиентов.
- Подбор аналогов.
- Поставку компонентов в любых объемах, удовлетворяющих вашим потребностям.
- Приемлемые сроки поставки, возможна ускоренная поставка.
- Доставку товара в любую точку России и стран СНГ.
- Комплексную поставку.
- Работу по проектам и поставку образцов.
- Формирование склада под заказчика.
- Сертификаты соответствия на поставляемую продукцию (по желанию клиента).
- Тестирование поставляемой продукции.
- Поставку компонентов, требующих военную и космическую приемку.
- Входной контроль качества.
- Наличие сертификата ISO.

В составе нашей компании организован Конструкторский отдел, призванный помогать разработчикам, и инженерам.

Конструкторский отдел помогает осуществить:

- Регистрацию проекта у производителя компонентов.
- Техническую поддержку проекта.
- Защиту от снятия компонента с производства.
- Оценку стоимости проекта по компонентам.
- Изготовление тестовой платы монтаж и пусконаладочные работы.



Тел: +7 (812) 336 43 04 (многоканальный)

Email: [org@lifeelectronics.ru](mailto:org@lifeelectronics.ru)