

# AMPMODU Interconnection System

RoHS  
Ready 

 **Tyco Electronics**  
Our commitment. Your advantage.

## Table of Contents

PC/104 and PC/104-Plus Connectors  
**1**

### Disclaimer

While Tyco Electronics Corporation and its affiliates referenced herein ("Tyco Electronics") have made every reasonable effort to confirm the accuracy of the information in this catalog, Tyco Electronics does not guarantee that it is error-free, nor does Tyco Electronics make any other representation, warranty or guarantee that the information is accurate, correct, reliable or current.

Tyco Electronics reserves the right to make any adjustments to the information contained herein at any time without notice. Tyco Electronics expressly disclaims all implied warranties regarding the information contained herein, including, but not limited to, any implied warranties of merchantability or fitness for a particular purpose. Tyco Electronics' only obligations are those in the Tyco Electronics Standard Terms and Conditions of Sale, and in no case will Tyco Electronics be responsible for any incidental, indirect, or consequential damages arising from the sale, resale, use or misuse of its products. Users should independently evaluate the suitability of, and test each product for, their application.

The dimensions, specifications, designs, construction, materials and processes in this catalog are for reference purposes only and are subject to change without notice. Please consult Tyco Electronics for the most current product information.

The export of certain Tyco Electronics products is restricted by the Arms Export Control Act (Title 22, U.S.C. Sec 2751, et seq.) or the Export Administration Act of 1979, as amended (Title 50, U.S.C., App. 2401 et seq.). Orders may be subject to export approval by the U.S. Government. Buyer must comply with all applicable export laws of all applicable jurisdictions.

© 2008 and 2004 Tyco Electronics Corporation. All Rights Reserved.

AMP, ACTION PIN, AMP-LATCH, AMP-O-ELECTRIC, AMP-O-MATIC, AMPLIMITE, AMPMODU, AMPOMATOR, CERTI-CRIMP, CHAMPOMATOR, PRO-CRIMPER, R-CAM, TE LOGO and TYCO ELECTRONICS are trademarks of Tyco Electronics Corporation.

Other products, logos, and company names mentioned herein may be trademarks of their respective owners.

**See inside back cover for Global Contacts and phone numbers.**

.050 x .050 [1.27 x 1.27] Centerline  
**2**

### 1 PC/104 and PC/104-Plus Connectors

Introduction	5
PC/104, Press Fit	6, 7
PC/104-Plus, Press Fit	8, 9
PC/104, Solder	10
PC/104-Plus, Solder	11
Accessories, Kits	12

.050 x .100 [1.27 x 2.54] Centerline  
**3**

### 2 0.050 [1.27] x 0.050 [1.27] CENTERLINE AMPMODU 50/50 Grid

#### Board-to-Board Vertical Receptacles and Headers:

Introduction	13, 14
Vertical Receptacles, Double Row	15
Vertical Headers, Double Row	16
Recommended PC Board Layouts	17

#### Board-to-Board Right-Angle Headers:

Introduction	18
Right-Angle Headers, Double Row, Latching and Non-Latching	19

#### Cable-to-Board Connectors:

Introduction	20
Receptacle Connectors, Double Row, With and Without Latch	21
Cable Connector Terminating Cover, Double Row	22
IDC (Insulation Displacement Crimp) Tooling	23

#### Performance Specifications

Technical Documents	24
---------------------	----

AMPMODU 2mm Connectors  
**4**

### 3 .050 [1.27] x 0.100 [2.54] CENTERLINE AMPMODU System 50

#### Board-to-Board Connectors, Thru-Hole:

Introduction	26
Headers, Shrouded and Unshrouded	27-35
Introduction	36
Receptacles	37-40
PC Board Hole Layouts	41, 42

#### Board-to-Board Connectors, Surface-Mount:

Introduction	43
Headers	44
Receptacles	45

#### Cable-to-Board Connectors, FFC Cable:

Introduction	46
Flexible Flat Conductor Cable	47
FFC Contacts	48
Receptacle Housings	49-52
ZIF-Line Connectors	53, 54

#### Cable-to-Board Connectors, Ribbon Cable:

Introduction	55
Ribbon Cable Receptacles	56
Paddleboard Receptacles	57
Flat Ribbon Cable	58, 59
Application Tooling for Flex Film Contacts	60

Application Tooling	60-62
Performance Specifications	63
Technical Documents	64

.100 x .100 [2.54 x 2.54] Centerline  
**5**

.125 x .125 [3.18 x 3.18] Centerline  
**6**

.156 [3.96] Centerline  
**7**

Shunts  
**8**

**Table of Contents** (Continued)

<b>4</b>	<b>AMPMODU 2mm Connectors</b>	
	AMPMODU 2mm Connectors (Board to Board)	65
	Headers, Unshrouded, Double Row, Thru-Hole Mount	66, 67
	Breakaway Headers, Unshrouded, Double Row, Thru-Hole Mount	68-70
	Breakaway Headers, Unshrouded, Double Row, Surface Mount	71, 72
	Stacking Header, Unshrouded, Double Row, Thru-Hole Mount	73
	Headers, Shrouded, Double Row, Thru-Hole, Right-Angle Mount	74, 75
	Headers, Shrouded, Double Row, Surface Mount	76, 77
	Headers, Shrouded, Double Row, Thru-Hole Mount with Cable Shrouds	78, 79
	Receptacles, Double Row, Thru-Hole, Vertical Mount	80, 81
	Receptacles, Double Row, Surface Mount, Right-Angle Mount	82
	Receptacles, Double Row, Thru-Hole, Right-Angle Mount	83
	Receptacles, Double Row, Surface Mount, Vertical Mount	84
<b>5</b>	<b>.100 [2.54] x .100 [2.54] CENTERLINE</b>	
	<b>Introduction</b>	85-87
	<b>Terms Explained</b>	87
	<b>Wire Sizes</b>	88
	<b>Contact Platings</b>	88
	<b>Mating Post Lengths</b>	88
	<b>Application Tooling</b>	88
	<b>Board-to-Board Solutions Guides, .100[2.54] Centerline Products</b>	89
	<b>Wire-to-Board Solutions Guide, .100[2.54] Centerline Products</b>	89
	<b>Mating Post Selection Guide</b>	90
	<b>Parallel Stacking Guide for Board-to-Board Applications</b>	91
	<b>Board-to-Board Products:</b>	
	Unshrouded Headers	92-100
	Breakaway and Retention Headers-Unshrouded	101-105
	Reeled Breakaway Headers	106, 107
	Surface Mount Breakaway Headers	108-110
	Unshrouded Stacking Headers- Breakaway	111-113
	Shrouded Headers	114-140
	Standard Profile	114-133
	Low Profile	134-140
	Shrouded Stacking Headers	141-144
	ACTION PIN Headers	145-149
	ACTION PIN Press-Fit Posts	150, 151
	Application Tooling for ACTION PIN Posts	152, 153
	ACTION PIN Stacking Connectors	154-161
	Application Tooling for AMP ACTION PIN Stacking Connectors	162
	0.025 [0.64] Square Posts	163
	0.025 [0.64] Square Continuous Posts	164, 165
	0.045 [1.14] Square Continuous Posts	166, 167
	Horizontal Mount Receptacle Assemblies, Mod II	168-173
	Vertical Mount Receptacle Assemblies, Mod II & Mod IV	174-184
	Surface Mount Vertical Receptacles, Mod IV	185-192
	Two-Piece Printed Circuit Board Connectors	193-202
	Accessories	203-205
	<b>Wire-to-Board Products:</b>	
	Locking Clip Contacts and Housings	206-209
	Mod IV Contacts and Housings	210-220
	Short Point Contacts and Housings	221-224
	MTE Interconnection System	225-250
	Surface Mount MTE Headers (Right-Angle & Vertical)	251, 252
	Interchangeable Contacts, Wire Crimp (Snap-In)	253, 254
	MT and Shielded MT Connectors	255-265
	Mini-Tandem Spring Receptacle Contacts	266-269
	<b>Application Tooling</b>	270-275
	<b>Technical Documents</b>	276-278

1  
PC/104 and PC/104-Plus Connectors

2  
.050 x .050 [1.27 x 1.27] Centerline

3  
.050 x .100 [1.27 x 2.54] Centerline

4  
AMPMODU 2mm Connectors

5  
.100 x .100 [2.54 x 2.54] Centerline

6  
.125 x .125 [3.18 x 3.18] Centerline

7  
.156 [3.96] Centerline

8  
Shunts

**Table of Contents** (Continued)

**1** PC/104 and PC/104-Plus Connectors

**2** .050 x .050 [1.27 x 1.27] Centerline

**3** .050 x .100 [1.27 x 2.54] Centerline

**4** AMPMODU 2mm Connectors

**5** .100 x .100 [2.54 x 2.54] Centerline

**6** .125 x .125 [3.18 x 3.18] Centerline

**7** .156 [3.96] Centerline

**8** Shunts

**6** .125 [3.18] x .125 [3.18] CENTERLINE  
Wire-to-Board Product:  
Level V IDC Connectors .....279-282

**7** .156 [3.96] CENTERLINE  
Mod I 0.031 x 0.062 Interconnection System  
Introduction .....283, 284  
Receptacles, Vertical and Horizontal Board Mount .....285, 286  
Receptacle Assemblies, Vertical and Horizontal Board Mount .....287-289  
Receptacles, Crimp Snap-In (Wire Applied) .....290  
Receptacle Housings, Standard Profile-Unkeyed (With/Without Strain Relief) ...291, 292  
Receptacle Housings, Low Profile-Keyed .....293  
Posts, Machined Applied .....294  
Headers:  
Straight Post, Keyed .....295, 296  
Right-Angle, Keyed .....297  
Locking Clip Contacts, Crimp Snap-In (Wire Applied) .....298  
Locking Clip Connector Housings, Single Row, Crimp Snap-In .....299  
Application Tooling .....300-304  
Performance Specifications .....305  
Technical Documents .....305

**8** Shunts  
Dual In-Line Package DIP Shunts .....306, 307  
Post Shunts .....308-310  
Performance Specifications .....311  
Technical Documents .....311  
Part Number Index .....313-316

**Restriction on the use of Hazardous Substances (RoHS)**

At Tyco Electronics, we're ready to support your RoHS requirements. We've assessed more than 1.5 million end items/components for RoHS compliance, and issued new part numbers where any change was required to eliminate the restricted materials. Part numbers in this catalog are identified as:

**RoHS Compliant** — Part numbers in this catalog are RoHS Compliant, unless marked otherwise. These products comply with European Union Directive 2002/95/EC as amended 1 January 2006 that restricts the use of lead, mercury, cadmium, hexavalent chromium, PBB, and PBDE in certain electrical and electronic products sold into the EU as of 1 July 2006.

NOTE: For purposes of this Catalog, included within the definition of RoHS Compliant are products that are clearly "Out of Scope" of the RoHS Directive such as hand tools and other non-electrical accessories.

NOTE: Information regarding RoHS compliance is provided based on reasonable inquiry of our suppliers and represents our current actual knowledge based on the information provided by our suppliers. This information is subject to change. For latest compliance status, refer to our website referenced at right.

**Getting the Information You Need**

Our comprehensive on-line RoHS Customer Support Center provides a forum to answer your questions and support your RoHS needs. A RoHS FAQ (Frequently Asked Questions) is available with links to more detailed information. You can also submit RoHS questions and receive a response within 24 hours during a normal work week. The Support Center also provides:

- Cross-Reference from Non-compliant to Compliant Products
- Ability to browse RoHS Compliant Products in our on-line catalog
- Downloadable Technical Data Customer Information Presentation
- More detailed information regarding the definitions used above
- So whatever your questions when it comes to RoHS, we have the answers at [www.tycoelectronics.com/leadfree](http://www.tycoelectronics.com/leadfree)



## PC/104 and PC/104-Plus Connectors

### Product Facts

- Press fit design — eliminates hand soldering
- Unitized PC/104 connector assembly — eliminates two piece (64 pin & 40 pin) configuration
- Integral board spacers with captive hardware — eases & improves assembly efficiency while minimizing stocked hardware
- “Flat-rock” insertable — no need for complex insertion tooling
- Recognized by Underwriters' Laboratories to US and Canadian standards  file No. E28476
- Fully compliant with PC104 & PC104-Plus standards
- Solutions available for lead free processes (ie. ENIG and silver immersion plated PCB's)

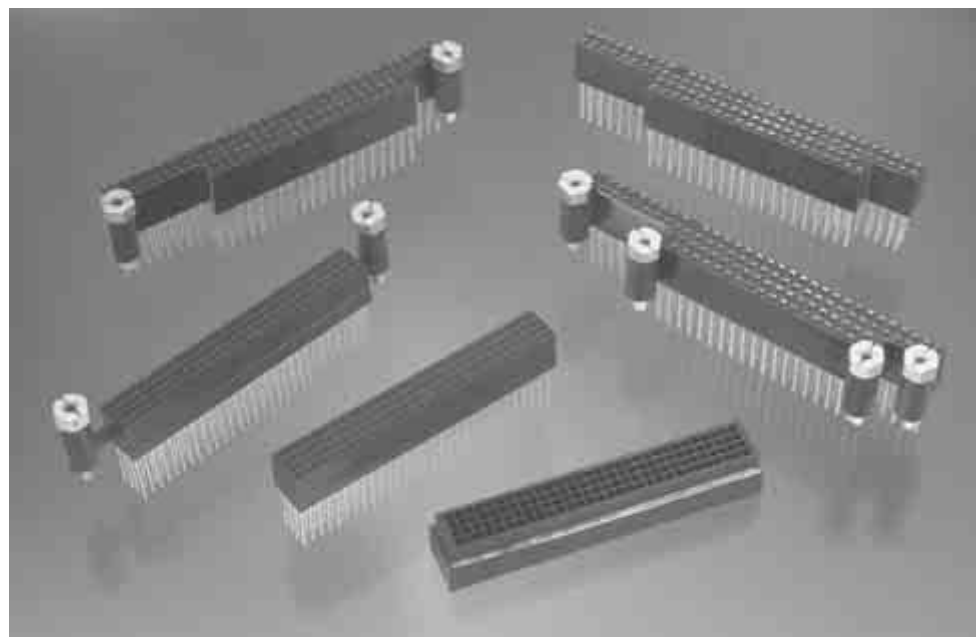
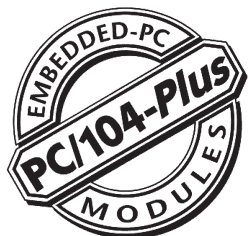

The PC/104 and PC/104-Plus connectors are industry standard product offerings which comply with the interconnection requirements defined by the PC/104 organization (<http://www.pc104.org>)

Both products are designed specifically for “flat-rock” press-fit installation for ease of application. Solder version is also available.

Optional integral standoffs minimize the customer's system assembly time.

The Tyco Electronics offering of the standard PC/104 product is a unitized connector rather than the two piece, 40 and 64 position connectors currently on the market. Customer needs to stock and apply only one part number rather than two.

### Performance Specifications

#### Electrical Characteristics

Meets requirements of PC/104 and PC/104-Plus standards

**Nominal Resistance** — 10 milliohms maximum,  $\Delta R$

**Insulation Resistance** — 1000 megohms minimum

**Dielectric Withstanding Voltage** — 500 VAC for 1 min. at sea level

#### Mechanical Characteristics

Meets requirements of PC/104 and PC/104-Plus standards

**Current** — Signal application only

**Temperature** — -55° to 105°C

#### Material and Finish

**Housing** — Black Thermoplastic, UL 94V-0

**Contact** — Phosphor Bronze, Full Gold all over Nickel (stackthrough), Gold on mating end, Tin or Tin-lead on PCB tail all over Nickel (non-stackthrough)

### Need more information?

Call Technical Support 1-800-522-6752:

Technical Support is staffed with specialists well versed in all Tyco Electronics products. The Center can provide you with:

- Technical Support
- Catalogs
- Technical Documents
- Tyco Electronics Authorized Distributor Locations

### Technical Documents

#### Product Specifications

108-1956

#### Application Specifications

114-13021

Connector	Centerline	Position
PC/104	.100 2.54	104*
PC/104-Plus	.079 2.0	120**

\*Two circuits plugged per PC/104 specification. Other options available.

\*\*One circuit plugged per PC/104-Plus specification. Other options available.

**PC/104, Press-Fit**

**Material and Finish**

**Housing** — Glass filled thermoplastic, Black, 94V-0 rated

**Contacts**

**Stackthrough** — Phosphor Bronze; plated .000015 [0.00038] min. Gold on mating receptacle end, .000005 [0.000130] min. Gold on remainder, all over .000050 [0.00127] Nickel

or  
Phosphor Bronze; plated .000015 [0.00038] min. Gold on mating receptacle end, .000100-.000200 [0.000254-.00508] matte tin on compliant section, .000005 [0.000130] min. Gold on remainder of post, all over .000050 [0.00127] Nickel

**Non-Stackthrough** — Phosphor Bronze; plated .000015 [0.00038] min. Gold on mating receptacle end, .000100 [0.00254] matte tin or tin-lead on remainder, all over .000050 [0.00127] Nickel

**Screwlocks** — Steel, Clear Chromate over Zinc

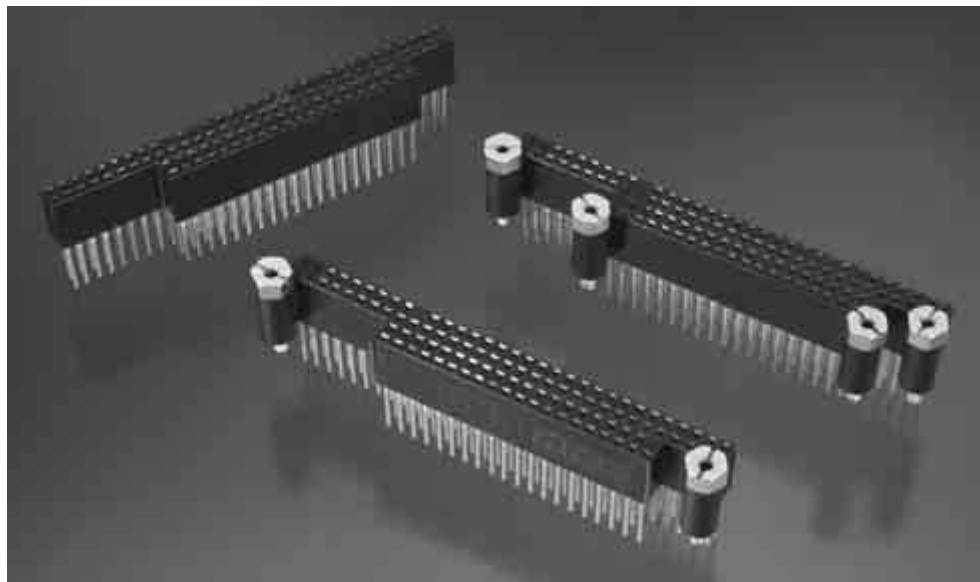

**Stackthrough, No Standoffs**

Gold plated contacts\*

**Part No. 1375795-1** (keyed), **Part No. 1375795-2** (unkeyed)

Gold plated contacts with Tin plated compliant pin section\*\*

**Part No. 1375795-3** (keyed), **Part No. 1375795-4** (unkeyed)

**Non-Stackthrough, No Standoffs**

Tin-lead plated tails\*

**Part No. 1375796-1** (keyed), **Part No. 1375796-2** (unkeyed)

Matte tin plated tails\*\*

**Part No. 1375796-3** (keyed), **Part No. 1375796-4** (unkeyed)

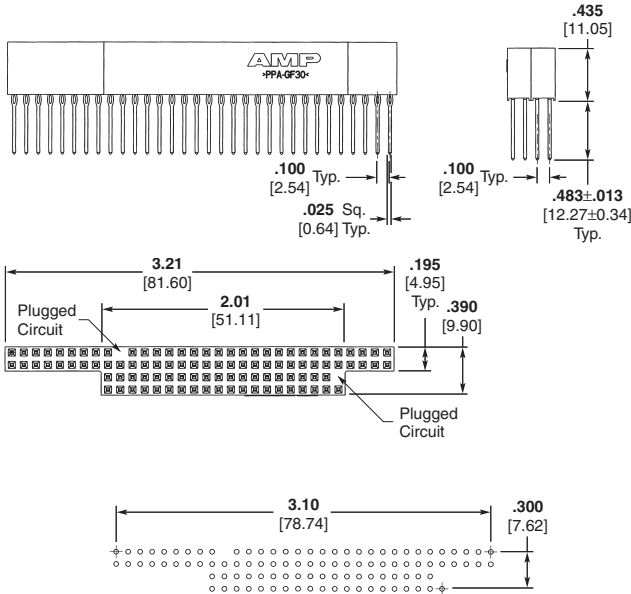

Keyed

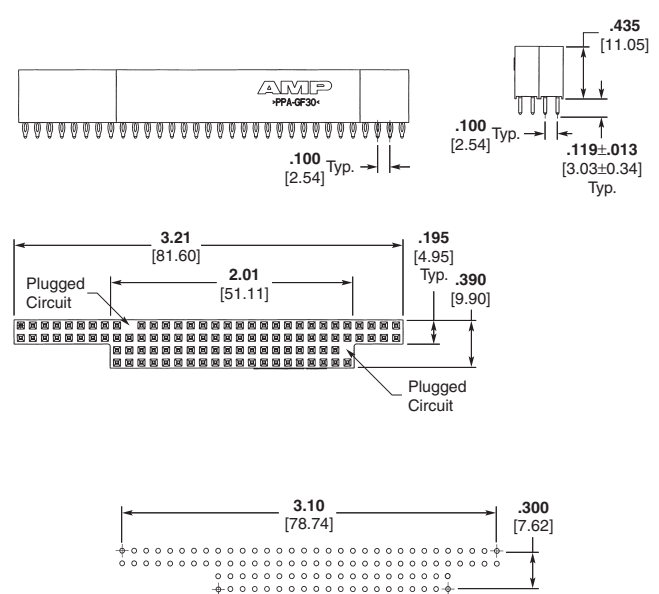

Unkeyed

**Recommended PC Board Layout**  
See Customer Drawing for  
Hole Geometry and Recommended Plating.

**Note:** All part numbers are RoHS compliant.

\* For RoHS exempt Tin-lead processes (including ENIG Plated PCB's)

\*\* for Silver Immersion processes or where a total lead free solution is desired

**PC/104, Press-Fit (Continued)**

**Stackthrough, 2 Standoffs**

Gold plated contacts\*

Part No. 1375793-1 (keyed), Part No. 1375793-2 (unkeyed)

Gold plated contacts with Tin plated compliant pin section\*\*

Part No. 1375793-3 (keyed), Part No. 1375793-4 (unkeyed)

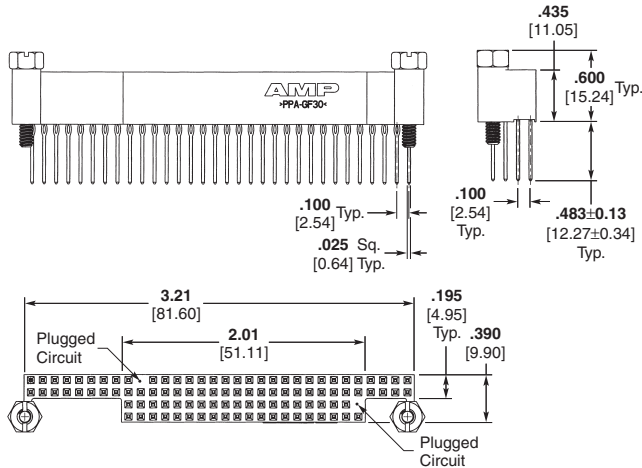

**Non-Stackthrough, 2 Standoffs**

Tin-lead plated tails\*

Part No. 1375794-1 (keyed), Part No. 1375794-2 (unkeyed)

Matte tin plated tails\*\*

Part No. 1375794-3 (keyed), Part No. 1375794-4 (unkeyed)

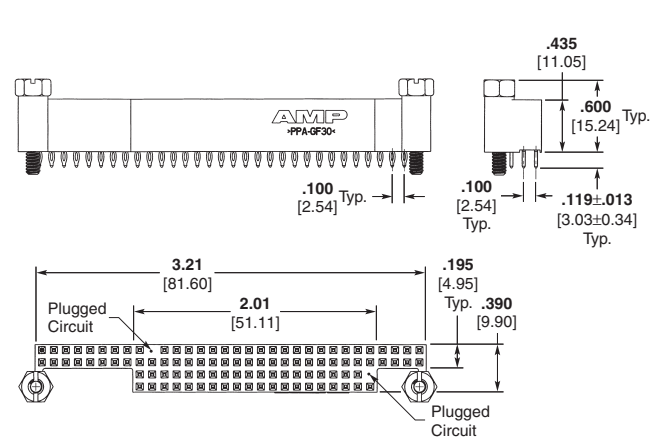

**Stackthrough, 4 Standoffs**

Gold plated contacts\*

Part No. 1375791-1 (keyed), Part No. 1375791-2 (unkeyed)

Gold plated contacts with Tin plated compliant pin section\*\*

Part No. 1375791-3 (keyed), Part No. 1375791-4 (unkeyed)

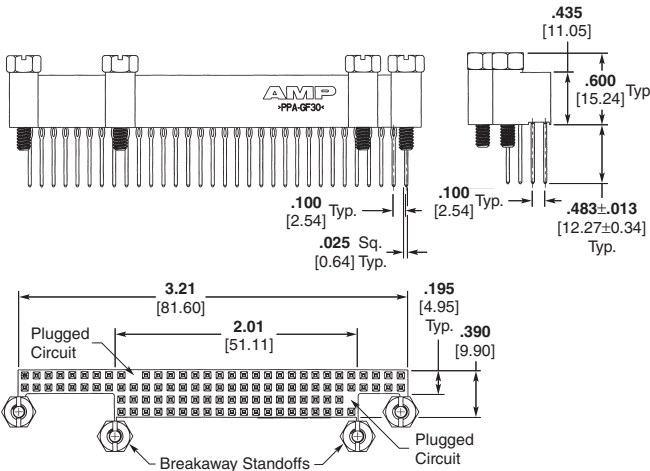

**Non-Stackthrough, 4 Standoffs**

Tin-lead plated tails\*

Part No. 1375792-1 (keyed), Part No. 1375792-2 (unkeyed)

Matte tin plated tails\*\*

Part No. 1375792-3 (keyed), Part No. 1375792-4 (unkeyed)

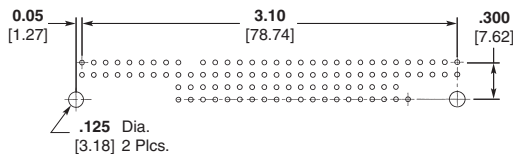
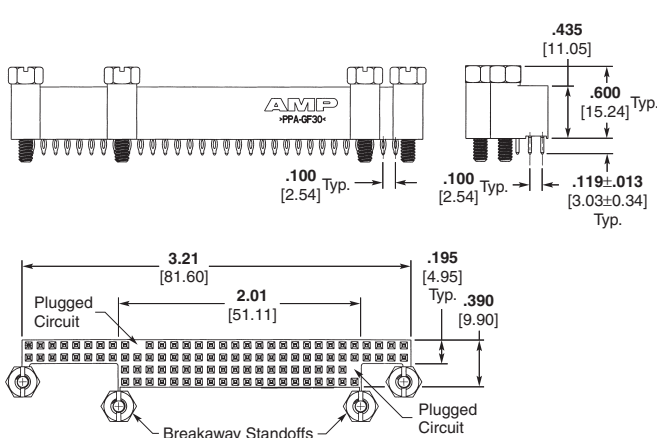

Keyed

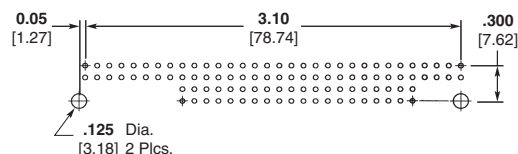

Unkeyed

**Recommended PC Board Layout**  
See Customer Drawing for  
Hole Geometry and Recommended Plating.

**Note:** All part numbers are RoHS compliant.

\* For RoHS exempt Tin-lead processes (including ENIG Plated PCB's)

\*\* for Silver Immersion processes or where a total lead free solution is desired

**PC/104-Plus, Press-Fit**

**Material and Finish**

**Housing** — Glass filled thermoplastic, Black, 94V-0 rated

**Contacts**

**Stackthrough** — Phosphor Bronze; plated .000015 [0.00038] min. Gold on mating receptacle end, .000005 [0.000130] min. Gold on remainder, all over .000050 [0.00127] Nickel

or  
Phosphor Bronze; plated .000015 [0.00038] min. Gold on mating receptacle end, .000100-.000200 [0.000254-.000508] matte tin on compliant section, .000005 [0.000130] min. Gold on remainder of post, all over .000050 [0.00127] Nickel

**Non-Stackthrough** — Phosphor Bronze; plated .000015 [0.00038] min. Gold on mating receptacle end, .000100 [0.00254] matte tin or tin-lead on remainder, all over .000050 [0.00127] Nickel

**Screwlocks** — Steel, Clear Chromate over Zinc

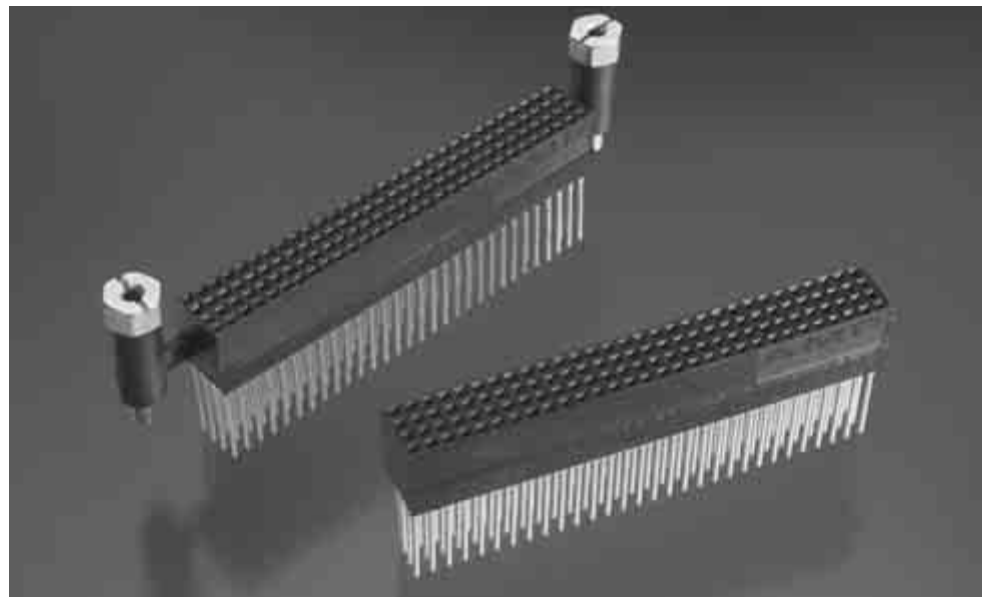

**Stackthrough, No Standoffs**

Gold plated contacts\*

- Part No. 1375799-1 (unkeyed)
- Part No. 1375799-2 (keyed-A1) per PC/104-Plus specification
- Part No. 1375799-3 (keyed-D30) per PC/104-Plus specification

Gold plated contacts with Tin plated compliant pin section\*\*

- Part No. 1375799-4 (unkeyed)
- Part No. 1375799-5 (keyed-A1) per PC/104-Plus specification
- Part No. 1375799-6 (keyed-D30) per PC/104-Plus specification

**Non-Stackthrough, No Standoffs**

Tin-lead plated tails\*

- Part No. 1375800-1 (unkeyed)
- Part No. 1375800-2 (keyed-A1) per PC/104-Plus specification
- Part No. 1375800-3 (keyed-D30) per PC/104-Plus specification

Matte tin plated tails\*\*

- Part No. 1375800-4 (unkeyed)
- Part No. 1375800-5 (keyed-A1) per PC/104-Plus specification
- Part No. 1375800-6 (keyed-D30) per PC/104-Plus specification

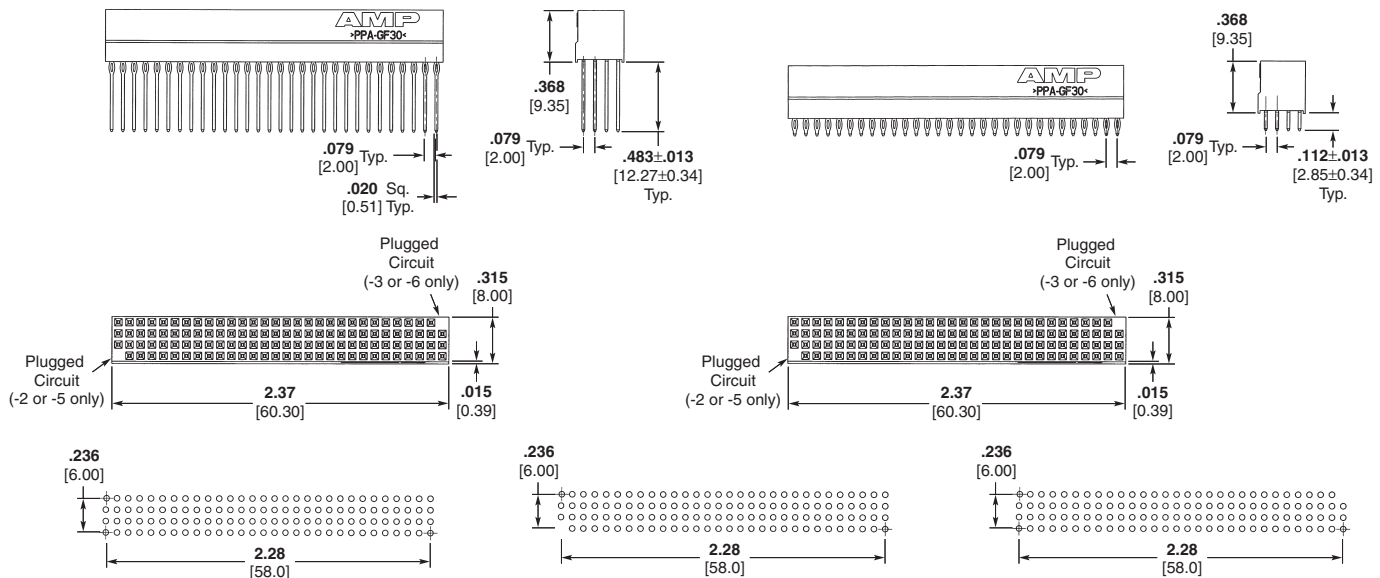

**Recommended PC Board Layout for 1375799-1, 1375799-4, 1375800-1, 1375800-4**

**Recommended PC Board Layout for 1375799-2, 1375799-5, 1375800-2, 1375800-5**

**Recommended PC Board Layout for 1375799-3, 1375799-6, 1375800-3, 1375800-6**

See Customer Drawing for Hole Geometry and Recommended Plating. (Including ENIG plated PCB's)

**Note:** All part numbers are RoHS compliant.

\* For RoHS exempt Tin-lead processes (including ENIG Plated PCB's)

\*\* for Silver Immersion processes or where a total lead free solution is desired



**PC/104-Plus, Press-Fit (Continued)**

**Non-Stackthrough, 2 Standoffs**

- Tin-lead plated tails\*
- Part No. 1375798-1 (unkeyed)
- Part No. 1375798-2 (keyed-A1) per PC/104-Plus specification
- Part No. 1375798-3 (keyed-D30) per PC/104-Plus specification

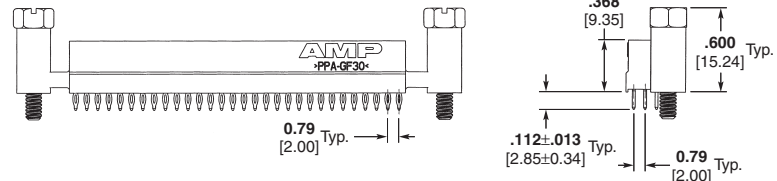

Matte tin plated tails\*\*

- Part No. 1375798-4 (unkeyed),
- Part No. 1375798-5 (keyed-A1) per PC/104-Plus specification
- Part No. 1375798-6 (keyed-D30) per PC/104-Plus specification

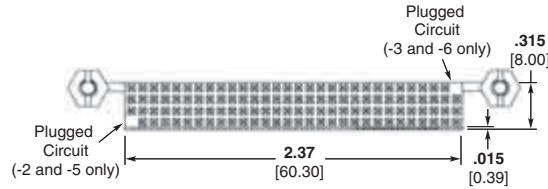

**Stackthrough, 2 Standoffs**

- Gold plated contacts\*
- Part No. 1375797-1 (unkeyed)
- Part No. 1375797-2 (keyed-A1) per PC/104-Plus specification
- Part No. 1375797-3 (keyed-D30) per PC/104-Plus specification

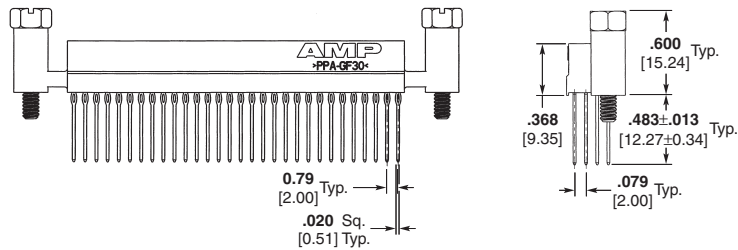

Gold plated contacts with Tin plated compliant pin section\*\*

- Part No. 1375797-4 (unkeyed)
- Part No. 1375797-5 (keyed-A1) per PC/104-Plus specification
- Part No. 1375797-6 (keyed-D30) per PC/104-Plus specification

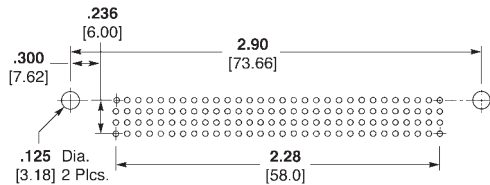
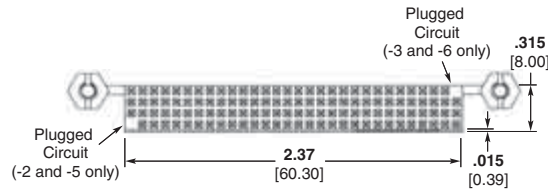

**Recommended PC Board Layout for 1375797-1, 1375797-4, 1375798-1, 1375798-4**

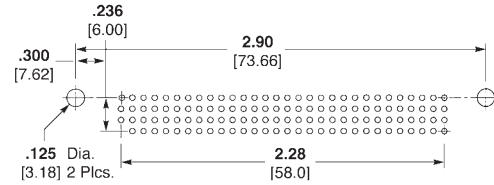

**Recommended PC Board Layout for 1375797-2, 1375797-5, 1375798-2, 1375798-5**

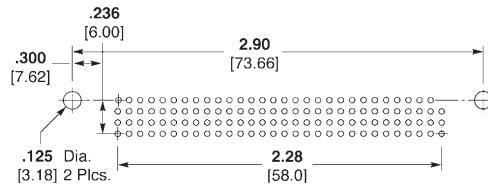

**Recommended PC Board Layout for 1375797-3, 1375797-6, 1375798-3, 1375798-6**

See Customer Drawing for Hole Geometry and Recommended Plating.

**Note:** All part numbers are RoHS compliant.

\* For RoHS exempt Tin-lead processes (including ENIG Plated PCB's)

\*\* for Silver Immersion processes or where a total lead free solution is desired

**PC/104, Solder**

**Material and Finish**

**Housing** — Glass filled thermoplastic, Black, 94V-0 rated

**Contacts**

**Non-Stackthrough** — Phosphor Bronze; plated .000015 [0.00038] min. Gold on mating receptacle end, .000100 [0.00254] matte tin on remainder, all over .000050 [0.00127] Nickel

**Screwlocks** — Steel, Clear Chromate over Zinc

**Non-Stackthrough, No Standoffs**

**Part No. 1375963-3** (keyed)  
**Part No. 1375963-4** (unkeyed)

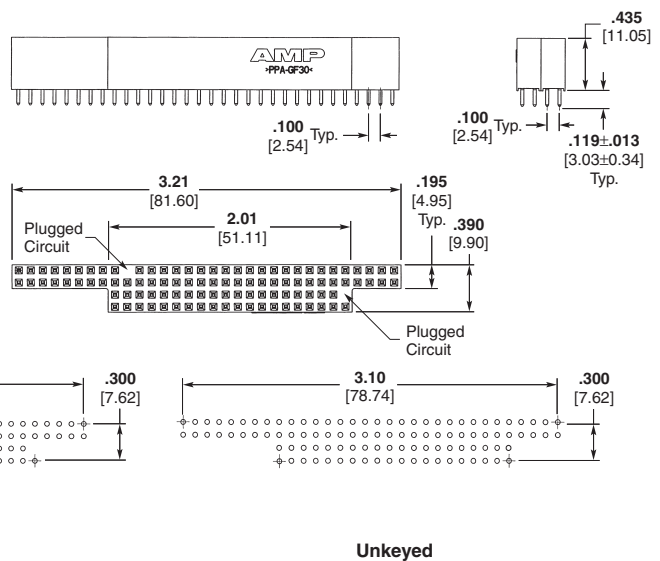

**Recommended PC Board Layout**

**Non-Stackthrough, 2 Standoffs**

**Part No. 1375961-3** (keyed)  
**Part No. 1375961-4** (unkeyed)

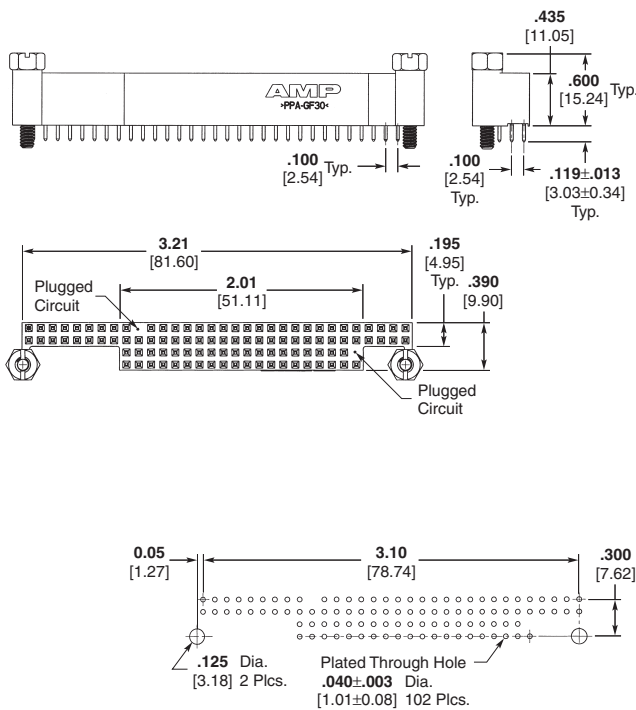

**Keyed**

**Unkeyed**

**Recommended PC Board Layout**

**Non-Stackthrough, 4 Standoffs**

**Part No. 1375959-3** (keyed)  
**Part No. 1375959-4** (unkeyed)

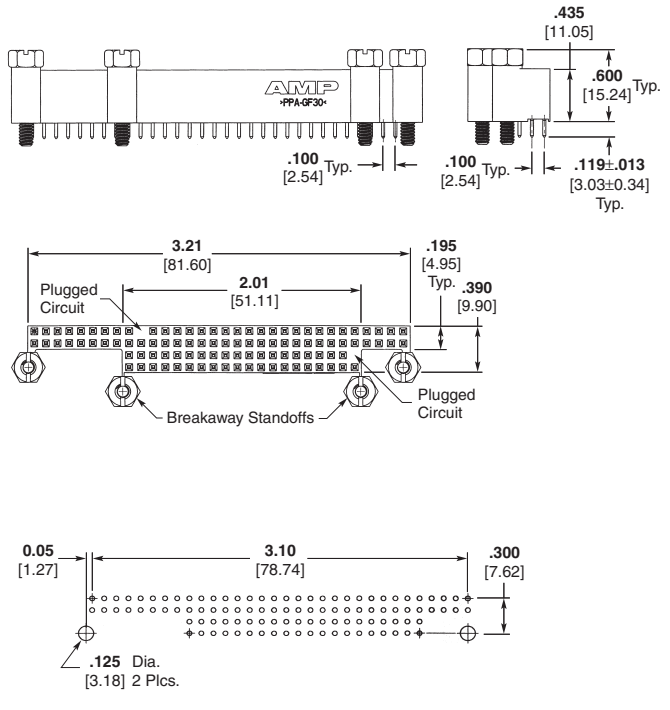

**Keyed**

**Unkeyed**

**Recommended PC Board Layout**

**Note:** All part numbers are RoHS compliant.

## PC/104-Plus, Solder

### Material and Finish

**Housing** — Glass filled thermoplastic, Black, 94V-0 rated

### Contacts

**Non-Stackthrough** — Phosphor Bronze; plated .000015 [0.00038] min. Gold on mating receptacle end, .000100 [0.00254] matte tin on remainder, all over .000050 [0.00127] Nickel

**Screwlocks** — Steel, Clear Chromate over Zinc

### Non-Stackthrough, No Standoffs

**Part No. 1375967-4** (unkeyed)

**Part No. 1375967-5** (keyed-A1)

per PC/104-Plus specification

**Part No. 1375967-6** (keyed-D30)

per PC/104-Plus specification

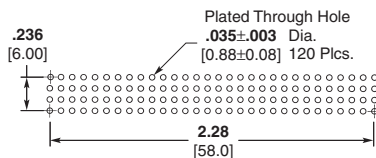
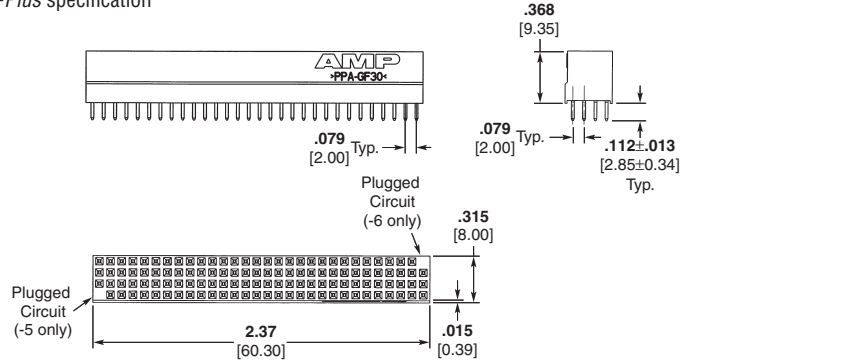

Recommended PC Board Layout for 1375967-4

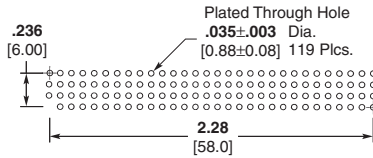

Recommended PC Board Layout for 1375967-5

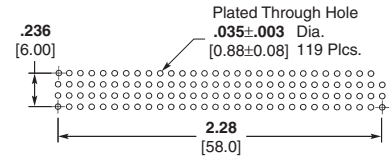

Recommended PC Board Layout for 1375967-6

### Non-Stackthrough, 2 Standoffs

**Part No. 1375965-4** (unkeyed)

**Part No. 1375965-5** (keyed-A1)

per PC/104-Plus specification

**Part No. 1375965-6** (keyed-D30)

per PC/104-Plus specification

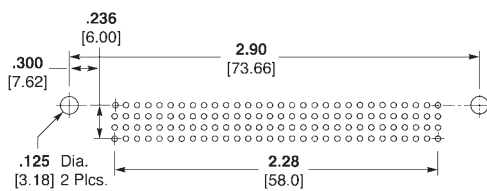
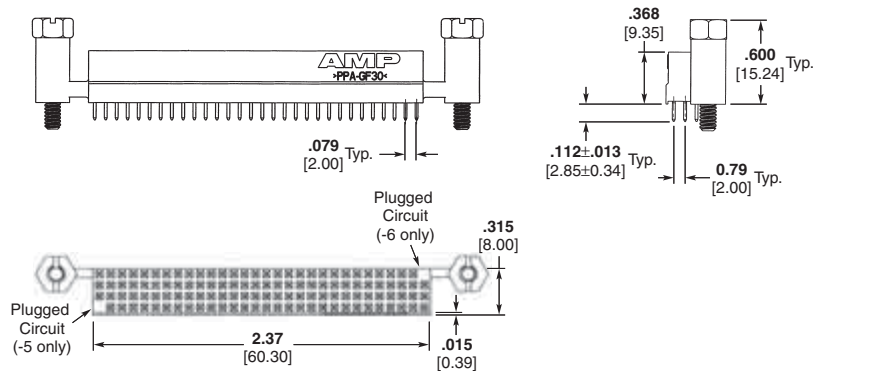

Recommended PC Board Layout for 1375965-4

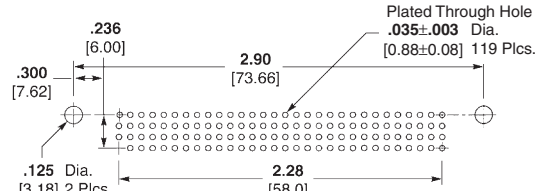

Recommended PC Board Layout for 1375965-5

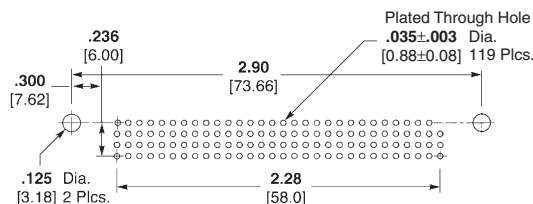

Recommended PC Board Layout for 1375965-6

**Note:** All part numbers are RoHS compliant.

**Accessories**

**Shroud, PC/104-Plus**  
Part No. 1375801-1

Material — PBT, Black

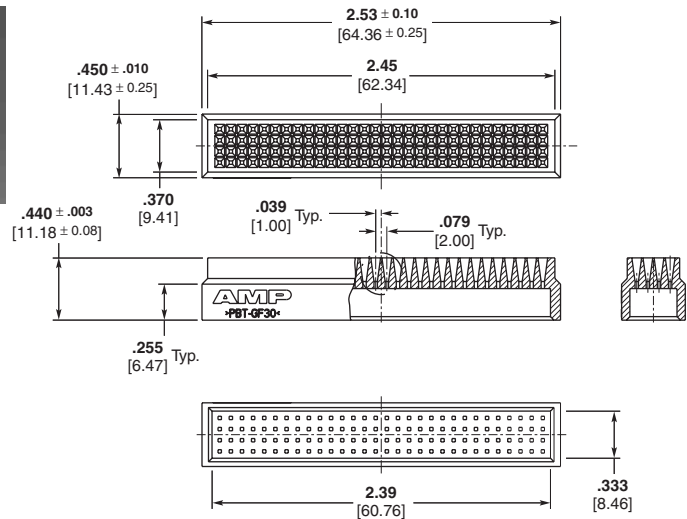

**Organizer, PC/104**  
Part Number 1445251-1

Material — Polyester, PBT, Black

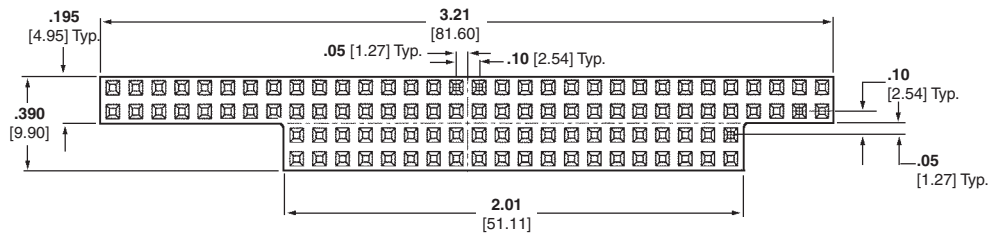

**Kit Packaging Part Numbers**

Part Number	Component Part Number		Style
	Connector Assembly	Organizer	
1445441-3	1375795-3	1445251-1	Keyed
1445441-4	1375795-4	1445251-1	Unkeyed
1445440-3	1375793-3	1445251-1	Keyed
1445440-4	1375793-4	1445251-1	Unkeyed
1445439-3	1375791-3	1445251-1	Keyed
1445439-4	1375791-4	1445251-1	Unkeyed

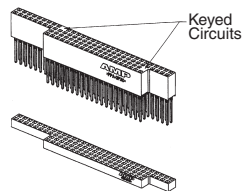

Part No. 1445441-3

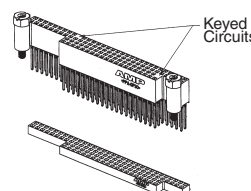

Part No. 1445440-3

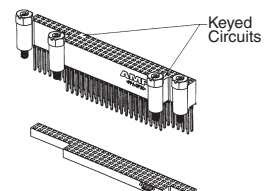

Part No. 1445439-3

**Note:** All part numbers are RoHS compliant.

**AMPMODU 50/50 Grid Connector System**

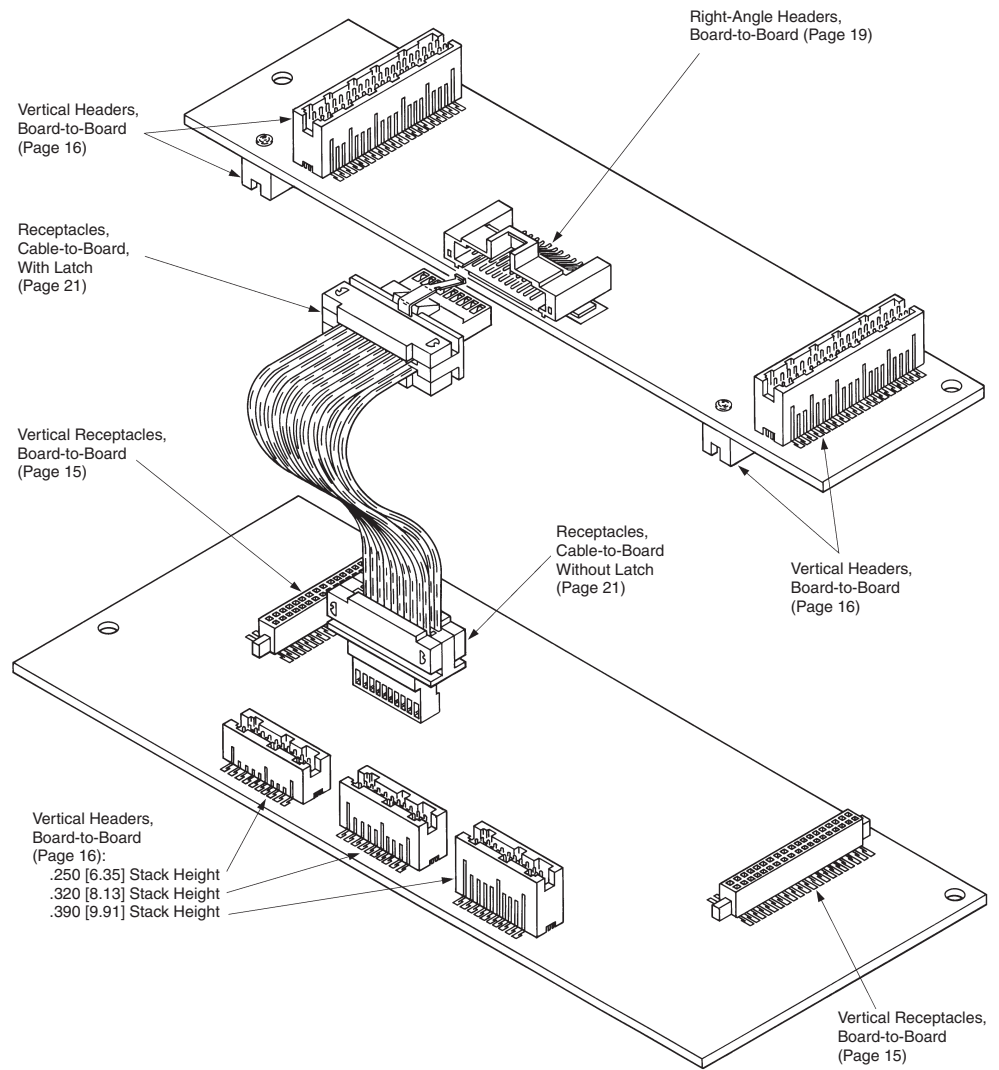



**Produced under a Quality Management System certified to ISO 9001**

A copy of the certificate is available upon request.



**Product Facts**

- Surface-mount products for parallel board-to-board applications, as well as right-angle board-to-board and cable-to-board applications
- High density .050 x .050 [1.27x1.27] centerline grid
- Three board-to-board stack heights: .250 [6.35], .320 [8.13] and .390 [9.91]
- Non-protrusive metallic holddowns
- Reliable dual beam receptacle contacts for redundant contact
- Duplex plated receptacle and post contacts; gold plated on mating areas, tin plated on tails
- Compatible with standard surface-mount processing (VPR and IR)
- Receptacle and header allow for drainage of processing fluids
- Tape and reel packaging available. Contact Tyco Electronics for details
- Polarized header and receptacle assemblies
- Sizes of 10, 20, 30, 40, 50, 60, 70, 80 and 100 positions
- Recognized under the Component Program of Underwriters Laboratories Inc., File No. E28476 
- Certified by Canadian Standards Association File No. LR7189 

**Board-to-Board Vertical Receptacles and Headers**

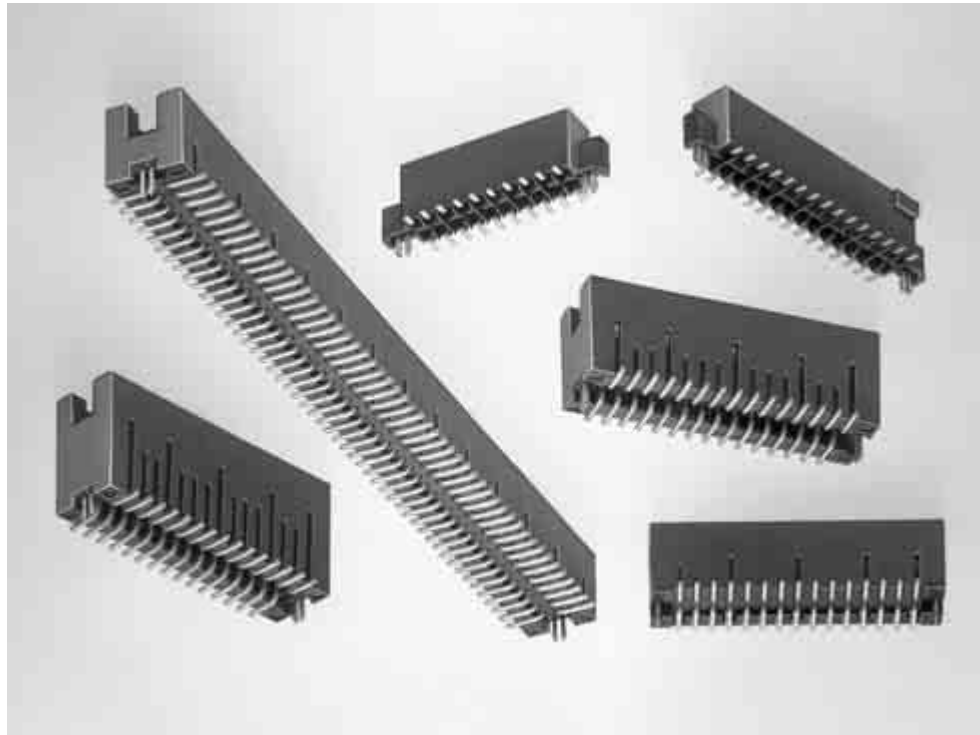

AMPMODU 50/50 Grid Vertical Headers and Receptacles are designed for parallel board-to-board stacking in high density applications.

Right-angle board-to-board and cable-to-board applications are also possible, since the vertical receptacles also mate with non-latching right-angle headers (page 19) and the vertical headers also mate with non-latching cable connectors.

Available are double row, vertical shrouded headers and receptacles in sizes ranging from 10 through 100 positions (in 10 position increments).

Parallel board-to-board stack heights of .250 [6.35], .320 [8.13] and .390 [9.91] are achievable by selection of the appropriate header. The receptacle is the same for all three stack height headers.

Non-protrusive metallic holddowns are designed for use in .062 [1.57] or thicker

PC boards and allow surface mounting to both sides of the board. In addition to providing retention during processing, the holddowns are soldered during reflow and therefore provide long-term strain relief for the solder joints.

AMPMODU 50/50 Grid Vertical Headers and Receptacles are designed to be compatible with standard surface-mount processes; IR (infrared) and VPR (vapor phase reflow). The surface-mount connectors have been designed so that dimensioning, tolerances, referenced datums, holddown characteristics

and packaging methods result in a system that is compatible with robotic assembly.

The headers and receptacles feature polarization to prevent misalignment.

**Three Board Stack Heights**

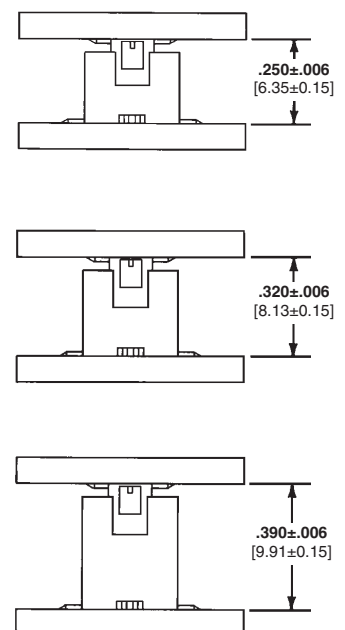

**Non-Protrusive Metallic Holddowns**

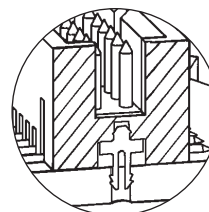

**Board-to-Board Vertical Receptacles, Double Row, .050 x .050 [1.27 x 1.27] Centerline**

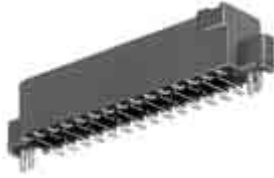

**Material and Finish**

**Housing**—Glass-filled thermoplastic, black, 94V-0 rated

**Contacts**—Copper alloy; duplex plated .000030 [0.00076] gold in mating area, .000150 [0.00381] tin on solder tail, with entire contact underplated .000050 [0.00127] nickel

**Holddown**—Copper alloy; plated .000150 [0.00381] tin over .000050 [0.00127] nickel

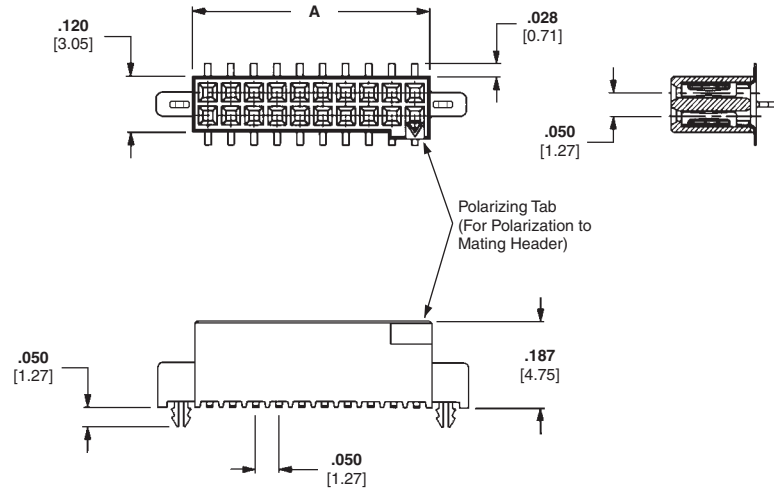

**Related Product Data**

**Mating Headers** — pages 16, 19

**PC Board Layouts** — page 17

**Performance Specifications** — page 24

**Technical Documents** — page 24

**Product Specification** 108-1332

**Application Specification** 114-7010

**Packaging:** Tube or Tape and Reel

No. of Pos.	Dimension A	Receptacle Part Numbers		
		Tube	Tape and Reel*	No Hold Down w/Vacuum Cover
10	.266 [6.75]	5-104652-1	5-147384-1	5-147413-1
20	.516 [13.11]	5-104652-2	5-147384-2	5-147413-3
30	.766 [19.46]	5-104652-3	5-147384-3	5-147413-4
40	1.016 [25.81]	5-104652-4	5-147384-4	—
50	1.266 [32.16]	5-104652-5	5-147384-5	5-147413-2
60	1.516 [38.51]	5-104652-6	5-147384-6	—
70	1.766 [44.86]	5-104652-7	5-147384-7	—
80	2.016 [51.21]	5-104652-8	5-147384-8	—
100	2.516 [63.91]	6-104652-0	5-147384-9	—

\* Parts packaged in tape and reel have vacuum pick and place cover. See PC Board Layout on page 17.

**Note:** All part numbers are RoHS compliant.

**Board-to-Board Vertical Headers, Double Row, .050 x .050  
[1.27 x 1.27] Centerline**



For .250 [6.35] Mated Height



For .320 [8.13] Mated Height



For .390 [9.91] Mated Height

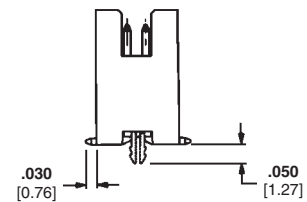
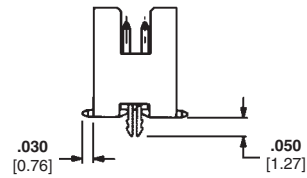
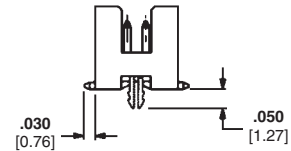
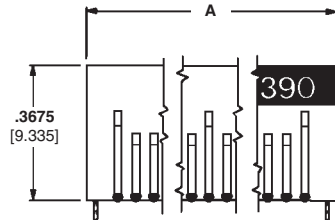
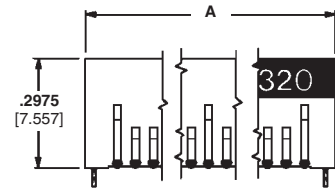
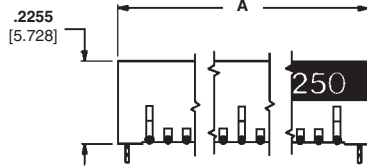
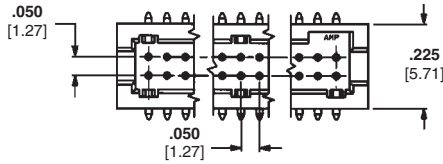

**Material and Finish**

**Housing**—Glass-filled thermoplastic, black, 94V-0 rated

**Contacts**—Copper alloy; duplex plated .000030 [0.00076] gold in mating area, .000150 [0.00381] tin on solder tail, with entire contact underplated .000050 [0.00127] nickel

**Holddown**—Copper alloy; plated .000150 [0.00381] tin over .000050 [0.00127] nickel

**Related Product Data**

**Mating Receptacles** — page 15, 21 (without latch only)

**PC Board Layouts** — page 17

**Performance Specifications** — page 24

**Technical Documents** — page 24

**Product Specification** 108-1332

**Application Specification** 114-7010

**Packaging:** Tube or Tape and Reel

No. of Pos.	Dimension A	Header Part Numbers								
		.250 [6.35] Mated Height			.320 [8.13] Mated Height		.390 [9.91] Mated Height			
		Tubes	Tape & Reel*		Tubes	Tape & Reel*	Tubes		Tape & Reel*	
		Hold Down	No Hold Down			Hold Down	No Hold Down			
10	.372 [9.44]	5-104655-1	5-147381-1	5-147121-1	5-104656-1	5-147382-1	5-104693-1	—	5-147383-1	
20	.622 [15.79]	5-104655-3	5-147381-2	5-147121-2	5-104656-2	5-147382-2	5-104693-2	—	5-147383-2	
30	.872 [22.14]	5-104655-4	5-147381-3	—	5-104656-3	5-147382-3	5-104693-3	—	5-147383-3	
40	1.122 [28.49]	5-104655-5	5-147381-4	—	5-104656-4	5-147382-4	5-104693-4	—	5-147383-4	
50	1.372 [34.84]	5-104655-6	5-147381-5	—	5-104656-5	5-147382-5	5-104693-5	—	5-147383-5	
60	1.622 [41.19]	5-104655-7	5-147381-6	—	5-104656-6	5-147382-6	5-104693-6	—	5-147383-6	
70	1.872 [47.54]	5-104655-8	5-147381-7	—	5-104656-7	5-147382-7	5-104693-7	—	5-147383-7	
80	2.122 [53.89]	5-104655-9	5-147381-8	—	5-104656-8	5-147382-8	5-104693-8	—	5-147383-8	
90	2.372 [60.24]	—	—	—	5-104656-9	—	5-104693-9	—	—	
100	2.622 [66.59]	6-104655-1	5-147381-9	—	6-104656-0	5-147382-9	6-104693-0	5-147503-1	5-147383-9	

\*Parts packaged in tape and reel have vacuum pick and place cover. See PC Board Layout on page 17.

**Note:** All part numbers are RoHS compliant.

Vertical Headers,  
Double Row  
**2**



## Recommended PC Board Layouts for Vertical Connectors

### Headers

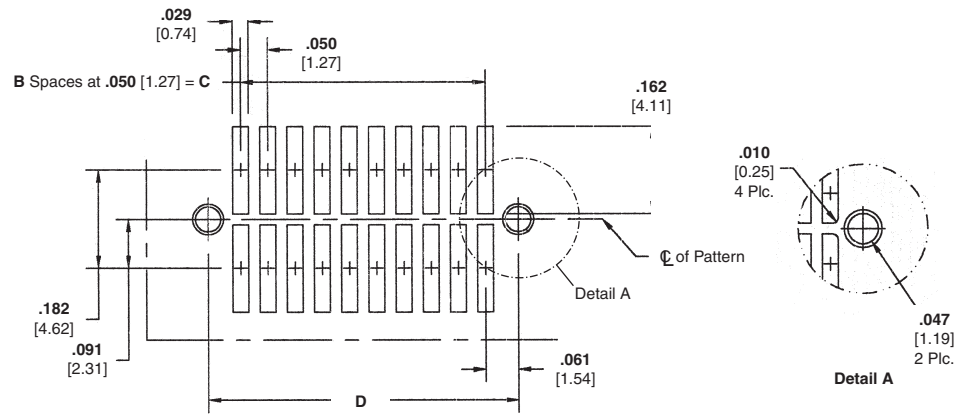

### Receptacles

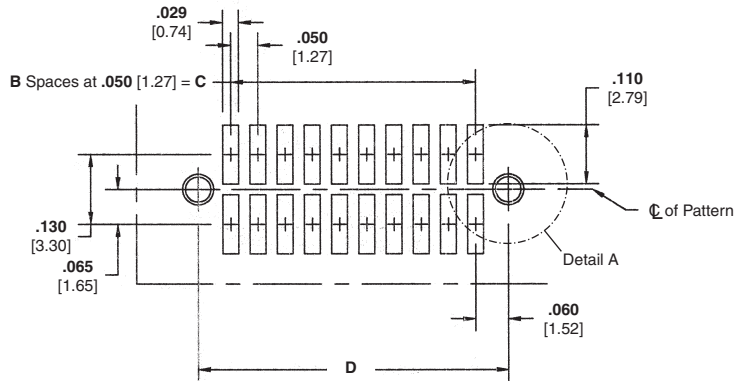

No. of Pos.	Receptacle Dimensions			Header Dimensions		
	B	C	D	B	C	D
10	4	.200 [5.08]	.320 [8.12]	4	.200 [5.08]	.322 [8.17]
20	9	.450 [11.43]	.570 [14.48]	9	.450 [11.43]	.572 [14.52]
30	14	.700 [17.78]	.820 [20.83]	14	.700 [17.78]	.822 [20.87]
40	19	.950 [24.13]	1.070 [27.19]	19	.950 [24.13]	1.072 [27.22]
50	24	1.200 [30.48]	1.320 [33.53]	24	1.200 [30.48]	1.322 [33.57]
60	29	1.450 [36.83]	1.570 [39.88]	29	1.450 [36.83]	1.572 [39.92]
70	34	1.700 [43.18]	1.820 [46.23]	34	1.700 [43.18]	1.822 [46.27]
80	39	1.950 [49.53]	2.070 [52.58]	39	1.950 [49.53]	2.072 [52.62]
90	44	2.200 [55.88]	2.320 [58.93]	44	2.200 [55.88]	2.322 [58.97]
100	49	2.450 [62.23]	2.570 [65.28]	49	2.450 [62.23]	2.572 [65.32]

**Note:** Refer to Tyco Electronics Customer Drawings for additional PC board layout information and dimensional tolerances.

**Note:** All part numbers are RoHS compliant.

## Board-to-Board Right-Angle Headers

### Product Facts

- Surface-mount products for right-angle board-to-board and cable-to-board applications
- Double-row, right-angle shrouded headers
- High density .050 x .050 [1.27 x 1.27] centerline grid
- Latching and non-latching versions available
- Non-protrusive metallic holddowns
- Metallic tabs, when soldered to PC board pad, provide added mechanical support
- Duplex plated post contacts; gold plated on mating area, tin plated on tails
- Compatible with standard surface-mount processing (VPR and IR)
- Standoffs on header housings allow for drainage of processing fluids
- All headers are polarized
- Sizes of 10, 20, 30, 40, 50, 60, 70, 80 and 100 positions
- Recognized under the Component Program of Underwriters Laboratories Inc., File No. E28476
- Certified by Canadian Standards Association File No. LR7189

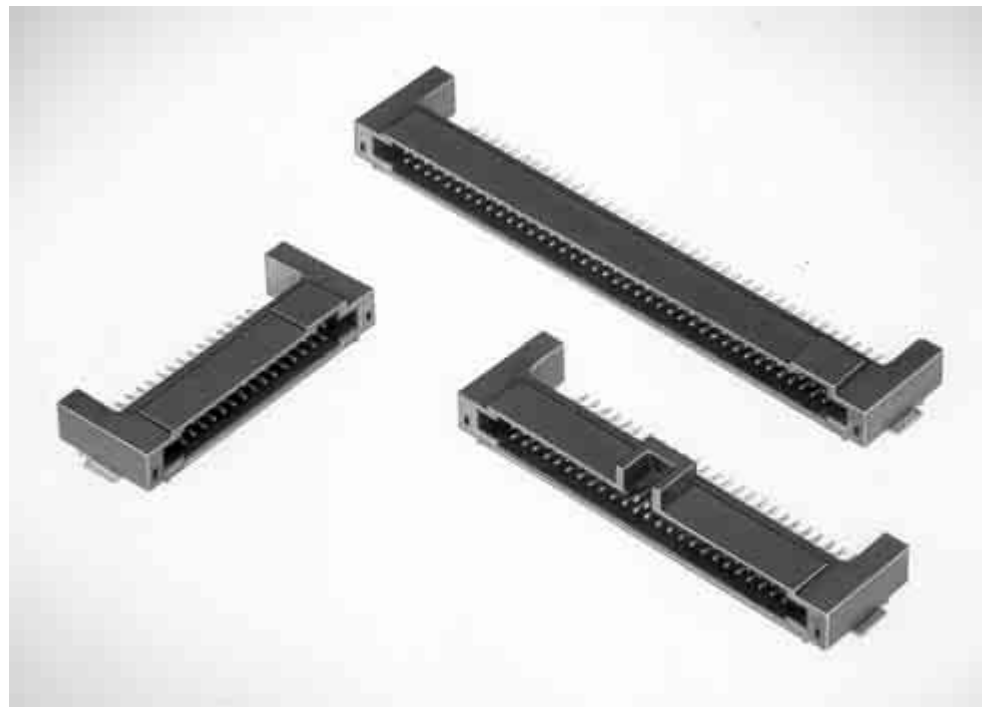

AMPMODU 50/50 Grid Right-Angle Headers will accommodate a variety of high density packaging applications; right-angle board-to-board applications when mated with vertical receptacles (page 15) and right-angle cable-to-board applications when mated with cable connectors (page 21). The small .050 x .050 [1.27 x 1.27] centerline contact spacing allows efficient use of the PC board area.

Mechanical support of the headers to the PC board is provided by non-protrusive metallic holddowns designed for .062 [1.57] or thicker PC boards. These holddowns are of the same

design as those used in the vertical headers (page 16) and receptacles (page 15). There are also metallic tabs that are soldered to the surfaces of the PC board pads for added support.

AMPMODU 50/50 Grid Right-Angle Headers are available in double-row, in either latching or non-latching versions, and in sizes ranging from 10 through 100 positions (in 10 position increments). The latching version provides positive retention when mated with the latching cable connector (page 21). All headers feature polarization to help prevent misalignment during mating.

**Board-to-Board Right-Angle Headers, Double Row, .050 x .050 [1.27 x 1.27] Centerline**

**Non-Latching Header**

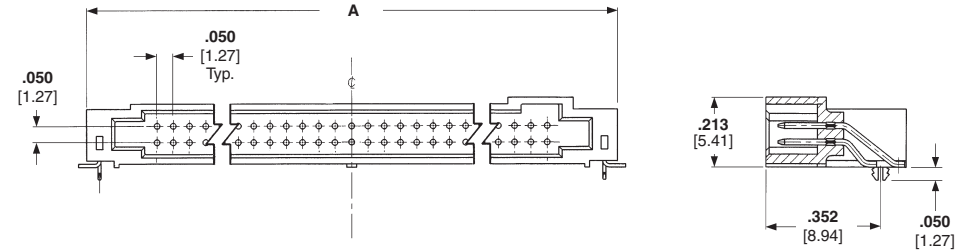

**Latching Header**

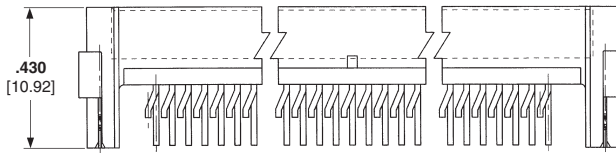
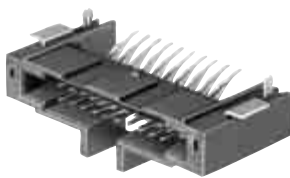

**Material and Finish**

**Housing** — Liquid crystal polymer, black, 94V-0 rated

**Contacts** — Copper alloy; duplex plated .000030 [0.00076] gold in mating area, .000150 [0.000381] tin on solder tail, with entire contact under-plated .000050 [0.00127] nickel

**Holddown** — Copper alloy; plated .0000150 [0.00381] tin over .000050 [0.00127] nickel

**Related Product Data**

**Mating Receptacles** — page 15, 21

**Performance Specifications** — page 24

**Technical Documents** — page 24

**Product Specification** 108-1443

**Application Specification** 114-7010

**Packaging:** Tube

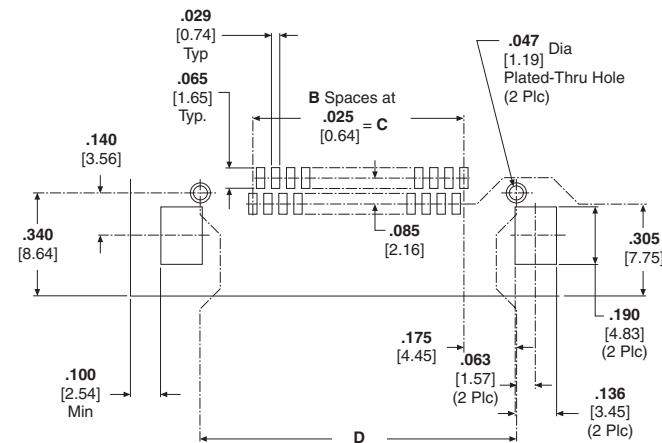

**Recommended PC Board Layout**



**Note:** Refer to Tyco Electronics Customer Drawings for additional PC board layout information and dimensional tolerances.

No. of Pos.	Dimensions				Header Part Numbers	
	A	B	C	D	Latching	Non-Latching
10	.630 [16.00]	9	.225 [5.72]	.550 [13.97]	5-104895-1	5-104894-1
20	.880 [22.35]	19	.475 [12.07]	.800 [20.32]	5-104895-2	5-104894-2
30	1.130 [28.70]	29	.725 [18.42]	1.050 [26.67]	5-104895-3	5-104894-3
40	1.380 [35.05]	39	.975 [24.77]	1.300 [33.02]	5-104895-4	5-104894-4
50	1.630 [41.40]	49	1.225 [31.12]	1.550 [39.37]	5-104895-5	5-104894-5
60	1.880 [47.75]	59	1.475 [37.47]	1.800 [45.72]	5-104895-6	5-104894-6
70	2.130 [54.10]	69	1.725 [43.82]	2.050 [52.07]	5-104895-7	5-104894-7
80	2.380 [60.45]	79	1.975 [50.17]	2.300 [58.42]	5-104895-8	5-104894-8
100	2.880 [73.15]	99	2.475 [62.87]	2.800 [71.12]	6-104895-0	6-104894-0

**Note:** All part numbers are RoHS compliant.

## Cable-to-Board Connectors

### Product Facts

- Double-row receptacle connectors provide cable-to-board connection capabilities for vertical headers (non-latching) and right-angle headers (latching and non-latching)
- IDC (Insulation Displacement Crimp) mass termination of solid or stranded round conductor .050 [1.27] centerline ribbon cable with PVC or polyethylene insulation
- Accommodates ribbon cable conductor sizes of 28 AWG [0.08-0.09 mm<sup>2</sup>] and 30 AWG [0.05 mm<sup>2</sup>] and insulation diameters up to .036 [0.91] maximum
- Reliable single beam receptacle contact design
- Duplex plated receptacle contacts; gold plated in mating area, tin in termination area
- Terminating covers (sold separately) provide both strain relief and protection to the termination area
- Sizes of 10, 20, 30, 40, 50, 60, 70, 80 and 100 positions
- Connectors available with or without metal latch
- Connectors without latches are polarized to help prevent mismatching
- Recognized under the Component Program of Underwriters Laboratories Inc.,  File No. E28476
- Certified by Canadian Standards Association  File No. LR7189



These double-row cable connectors, with a .050 x .050 [1.27 x 1.27] centerline contact spacing, provide cable-to-board connection capabilities for the AMPMODU 50/50 Grid Connector System. Cable connectors without a latch will mate with the vertical headers (page 16), while cable connectors with or without a latch can be used to mate with the right-angle headers (page 19).

The cable connectors feature reliable single-beam IDC (insulation displacement crimp) contacts which are duplex plated with .000030 [0.00076] gold. These contacts can be mass terminated to either solid or

stranded round conductor ribbon cable with conductor sizes of 28 AWG [0.08-0.09 mm<sup>2</sup>] and 30 AWG [0.05 mm<sup>2</sup>] and a maximum insulation diameter of .036 [0.91]. During termination, the terminating covers, which must be purchased separately, assist in guiding the wire into the IDC contacts, then provide strain relief when fully seated. Actual termination is accomplished with the Tyco Electronics manual tooling shown on page 23.

The latching version of the cable connector is equipped with a metal latch which provides positive retention of the receptacle cable connector when mated with a surface-

mounted right-angle header. The cable connector without a metal latch features polarization to help prevent mismatching. All connectors are available in sizes ranging from 10 through 100 positions (in 10 position increments).

**Cable-to-Board Receptacle Connectors, Double Row, .050 x .050 [1.27 x 1.27] Centerline**

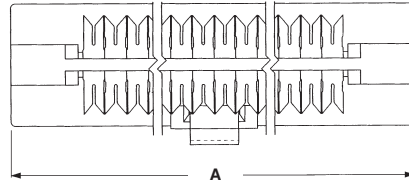
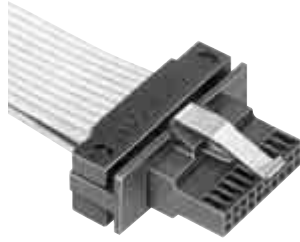

**Material and Finish**

**Housing** — Thermoplastic, black, 94V-0 rated

**Latch** — Stainless steel

**Contacts** — Phosphor bronze; duplex plated .000030 [0.00076] minimum gold in mating area, .000150 [0.00381] minimum tin on solder tail, with entire contact underplated .000050 [0.00127] minimum nickel

**Related Product Data**

**Mating Headers** — page 16, 19 (latching)

**Terminating Covers (Must be Purchased Separately, 2 Required per Connector)** — page 22

**Termination Tooling** — page 23

**Performance Specifications** — page 24

**Technical Documents** — page 24

**Product Specification** 108-1443

**Application Specification** 408-9817, 408-9909

**Packaging:** Tube

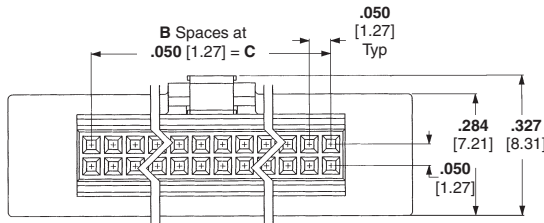
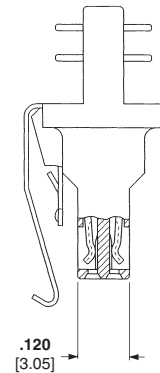
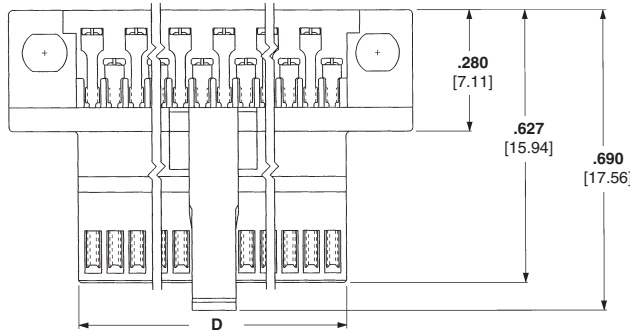

No. of Pos.	Dimensions				Receptacle Part Numbers	
	A	B	C	D	With Latch	Without Latch
10	.578 [14.68]	4	.200 [5.08]	.266 [6.76]	5-104892-1	5-104893-1
20	.828 [21.03]	9	.450 [11.43]	.516 [13.11]	5-104892-2	5-104893-2
30	1.078 [27.38]	14	.700 [17.78]	.766 [19.46]	5-104892-3	5-104893-3
40	1.328 [33.73]	19	.950 [24.13]	1.016 [25.81]	5-104892-4	5-104893-4
50	1.578 [40.08]	24	1.200 [30.48]	1.266 [32.16]	5-104892-5	5-104893-5
60	1.828 [46.43]	29	1.450 [36.83]	1.516 [38.51]	5-104892-6	5-104893-6
70	2.078 [52.78]	34	1.700 [43.18]	1.766 [44.86]	5-104892-7	5-104893-7
80	2.328 [59.13]	39	1.950 [49.53]	2.016 [51.21]	5-104892-8	5-104893-8
100	2.828 [71.83]	49	2.450 [62.23]	2.516 [63.91]	6-104892-0	6-104893-0

**Note:** All part numbers are RoHS compliant.

**Terminating Covers for Cable Connectors**



Cable Connector Terminating Cover, Double Row

**Material**

Glass-filled thermoplastic, black, 94V-0 rated

**Related Product Data**

**Connectors used with Covers** — page 21

**Termination Tooling** — page 23

**Technical Documents** — page 24

**Product Specification** 108-1443

**Application Specification** 408-9817, 408-9909

**Packaging:** Plastic bag

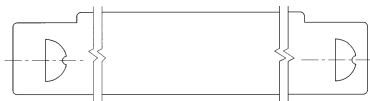
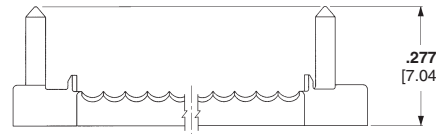
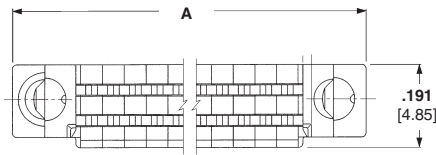

No. of Pos.	Dimension A	Terminator Cover Part Numbers
10	.565 [14.35]	104891-1
20	.815 [20.70]	104891-2
30	1.065 [27.05]	104891-3
40	1.315 [33.82]	104891-4
50	1.565 [39.75]	104891-5
60	1.815 [46.10]	104891-6
70	2.065 [52.45]	104891-7
80	2.315 [58.80]	104891-8
100	2.815 [71.50]	1-104891-0

**Note:** Terminating covers must be purchased separately, two are required for each cable connector.

**Note:** All part numbers are RoHS compliant.

**Application Tooling for Cable Connectors**

The Manual Miniature Application Frame Assembly 91295-1, equipped with a Cover Closing Kit 543518-1, is used for the IDC termination of ribbon cable to the cable connectors shown on page 21.

Prior to termination, the covers must be partially assembled onto a connector housing, the cable inserted between the covers and contacts and the covers preclosed by hand, clamping the cable in place.

In the Manual Miniature Application Frame Assembly, the covers are fully seated to complete the mass termination and provide strain relief for the completed connection.

For tooling information, call Technical Support Center **1-800-522-6752**.



**Manual Miniature Application Frame Assembly 91295-1 with Cover Closing Kit 543518-1**

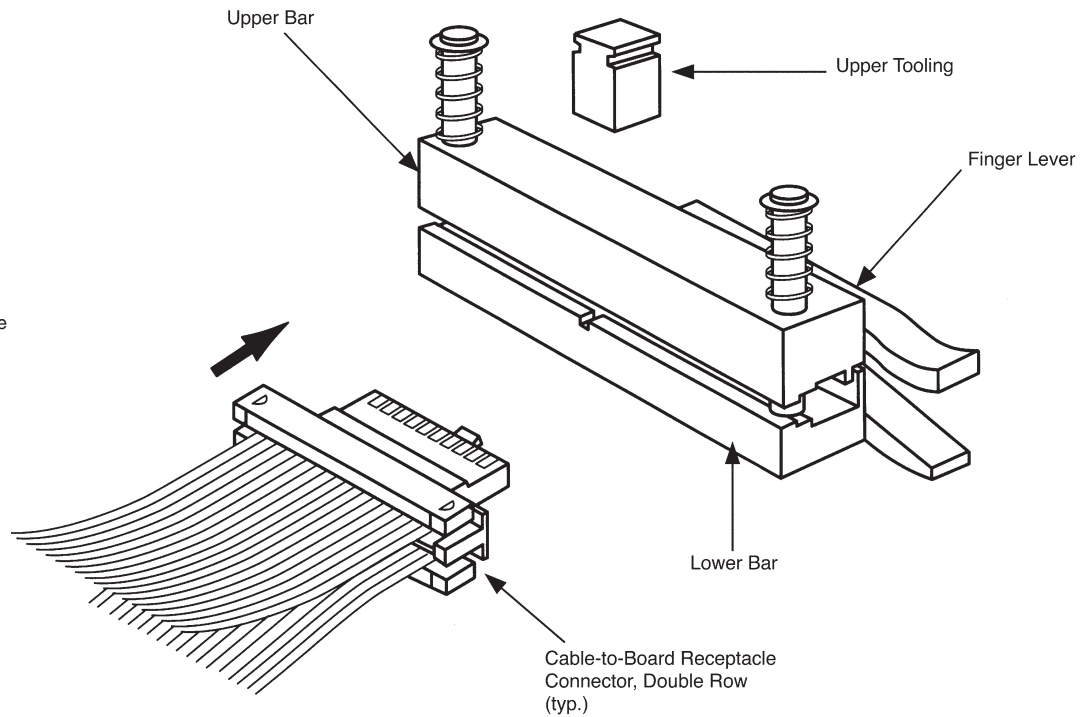

**Note:** Refer to Tyco Electronics Instruction Sheets 408-9817 (Frame Assembly 91295-1) and 408-9909 (Cover Closing Kit 543518-1) for complete termination/tooling information.

**Note:** All part numbers are RoHS compliant.

## Performance Specifications

### Board-to-Board Connectors, Vertical and Right-Angle

**Mating Force:** 6.4 oz (1.78 N) max. per contact  
**Unmating Force:** 1.0 oz [0.28 N] min. per contact  
**Durability:** Tested to 200 cycles min.  
**Current Rating:** (30°C T rise): .5 ampere per contact  
**Operating Temperature Range:** -65°C to +105°C  
**Termination Resistance:** 16 milliohms max. (initial)  
**Insulation Resistance:** 5000 megohms min. (initial)  
**Dielectric Withstanding Voltage:** 300 VAC

### Cable-to-Board Connectors

**Mating Force:** 6.4 oz (1.78 N) max. per contact  
**Unmating Force Without Latch:** .5 oz [0.14 N] min. per contact  
**Durability:** Tested to 200 cycles min.  
**Current Rating:** (10°C T rise): .5 ampere per contact  
**Operating Temperature Range:** -65°C to +105°C  
**Termination Resistance:** 25 milliohms max. (initial and final)  
**Insulation Resistance:** 5000 megohms min. (initial)  
**Dielectric Withstanding Voltage:** 300 VAC

## Technical Documents

Various technical documents are available for your use:

**Product Specifications** describe technical performance characteristics and verification tests. They are intended for the Design, Component and Quality Engineer.

108-1332	AMPMODU 50/50 Grid Vertical Board-to-Board Connectors
108-1443	AMPMODU 50/50 Grid Right-Angle Board-to-Board and Cable Connectors

**Application Specifications** describe requirements for using the product in its intended application and/or crimping information. They are intended for the Packaging and Design Engineer and the Machine Setup Person.

114-7010	AMPMODU 50/50 Grid Connector System
----------	-------------------------------------

**Instruction Sheets** provide instructions for assembling or applying the product. They are intended for the Manufacturing Assembler or Operator.

408-9817	Manual Miniature Application Frame Assembly 91295-1
408-9909	Cover Closing Kit 543518-1

**Note:** All part numbers are RoHS compliant.



Компания «Life Electronics» занимается поставками электронных компонентов импортного и отечественного производства от производителей и со складов крупных дистрибьюторов Европы, Америки и Азии.

С конца 2013 года компания активно расширяет линейку поставок компонентов по направлению коаксиальный кабель, кварцевые генераторы и конденсаторы (керамические, пленочные, электролитические), за счёт заключения дистрибьюторских договоров

Мы предлагаем:

- Конкурентоспособные цены и скидки постоянным клиентам.
- Специальные условия для постоянных клиентов.
- Подбор аналогов.
- Поставку компонентов в любых объемах, удовлетворяющих вашим потребностям.
- Приемлемые сроки поставки, возможна ускоренная поставка.
- Доставку товара в любую точку России и стран СНГ.
- Комплексную поставку.
- Работу по проектам и поставку образцов.
- Формирование склада под заказчика.
- Сертификаты соответствия на поставляемую продукцию (по желанию клиента).
- Тестирование поставляемой продукции.
- Поставку компонентов, требующих военную и космическую приемку.
- Входной контроль качества.
- Наличие сертификата ISO.

В составе нашей компании организован Конструкторский отдел, призванный помогать разработчикам, и инженерам.

Конструкторский отдел помогает осуществить:

- Регистрацию проекта у производителя компонентов.
- Техническую поддержку проекта.
- Защиту от снятия компонента с производства.
- Оценку стоимости проекта по компонентам.
- Изготовление тестовой платы монтаж и пусконаладочные работы.



Тел: +7 (812) 336 43 04 (многоканальный)

Email: [org@lifeelectronics.ru](mailto:org@lifeelectronics.ru)