

Electronic multifunction counters with preselection

→ Up counters/Down counters - 48 x 48 - CTR48E "Essential"

- Counter, Preselection chronometer
- Maximum input frequency 5 k Hz
- Simple parameter setting, configuration using text menus
- Easy modification of presets
- Multiplication factor
- 3 A changeover relay
- Backlit LCD display (green) : 6 digits, height 9 mm
- IP 65 sealed panel
- Option of locking the keypad, completely or partially (preset, programming)
- Accessories for 72 x 72 or 55 x 55 cut-out, DIN rail adaptor



Part numbers

| Type | Functions | Preset | Voltages | Output | Code |
|---------------------------|-----------------------------------|--------|-----------------------------------|-----------------------------------|----------|
| Green backlit LCD display | Counter, Preselection chronometer | 1 | 10 → 30 V $\overline{\text{---}}$ | 1 relay | 87629111 |
| | Counter, Preselection chronometer | 1 | 115 V \sim | 1 relay | 87629113 |
| | Counter, Preselection chronometer | 1 | 230 V \sim | 1 relay | 87629114 |
| | Counter, Preselection chronometer | 2 | 10 → 30 V $\overline{\text{---}}$ | 1 changeover relay, 1 NO relay | 87629121 |
| | Counter, Preselection chronometer | 2 | 115 V \sim | 1 changeover relay, 1 NO relay | 87629123 |
| | Counter, Preselection chronometer | 2 | 230 V \sim | 1 changeover relay, 1 NO relay | 87629124 |

Accessories

| Description | Code |
|--------------------------------|----------|
| Adaptor for 72 x 72 mm cut-out | 26546842 |
| Adaptor for 55 x 55 mm cut-out | 26546846 |
| DIN rail adaptor | 26546841 |

General characteristics

Environmental characteristics

| | |
|-------------------------------------|---|
| Supply | 11 → 30 V $\overline{\text{---}}$ / 115 V \sim / 230 V \sim |
| Relative humidity (no condensation) | EN 60068-2-30 40/93% RLF |
| Altitude | 0 < 2000 m |
| Certifications | CE |
| Vibration resistance in 3 axes | 10-55 Hz/1 min/XYZ EN 60068-2-6: 30 min. in each direction |
| Connection by screw terminals | Débrochable |
| Protection | Conforming to standard EN 60529 IP65 for panel/IP20 for connections |
| Front panel watertight seal | ✓ |
| Temperature limits use (°C) | -10 → +50 |
| Temperature limits stored (°C) | -25 → +75 |
| Weight (g) | 150 $\overline{\text{---}}$ version 250 \sim version |

General characteristics

| | |
|--|---|
| Reset to zero or to preset | On panel: if not locked during programming Electrical: automatic, voltage or solid state (NPN or PNP depending on programming) |
| Minimum pulse time | Impulse counter: < 15 ms Chronometer: 500 μ s |
| Option to protect against reset from front panel | ✓ |
| Scale factor (each input pulse is multiplied by this figure) | 00.0001 → 99.9999 |
| Decimal point selectable for ease of reading | 0 0.0 0.00 0.000 0.0000 0.00000 |
| Sensor supply version \sim | -40/+15% 50 mA 230 V \sim -40/+15% 40 mA 115 V \sim |
| Programming and current value backed up via EEPROM memory | ✓ |
| | Service life 10 years |

Operating characteristics

| | |
|--------------------|-----------------------------------|
| Functions | Preselection counter, Chronometer |
| Number of presets | 1 or 2 |
| Display | LCD with green backlighting |
| Height digits (mm) | LCD 9 |
| Display details | - 999 999 → 999 999 |

Input characteristics

| | |
|-------------|--|
| Inputs | 2 counter inputs 1 reset input, 1 locking input |
| Input modes | Dir: Directional AS: up/dn PP: phase |
| Input type | Voltage or solid state |
| High level | 3.5 → 30 V _{DC} |
| Low level | 0 → 2 V _{DC} |

Relay output characteristics

| | |
|------------------------------------|--|
| Changeover relay | ✓ |
| NO contact | Depending on version |
| Maximum current | 3 A |
| Minimum current | 30 mA |
| Maximum voltage | 30 V _{DC} / 250 V _{AC} |
| Min. voltage | 5 V _{AC} |
| Response time | < 10 ms |
| Mechanical life (operations) | 20 x 10 ⁶ |
| Number of operations | 1 x 10 ⁵ |
| Output modes: maintained or pulsed | 0.01 → 99.99 s |

Dimensions (mm)

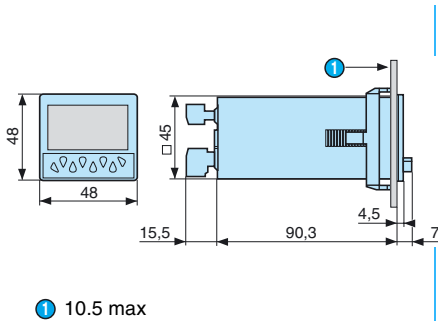

1 10.5 max

Panel cut-out

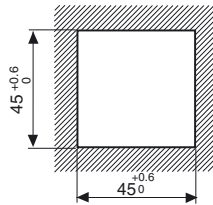

26546842 - Adaptor for 72 x 72 mm cut-out

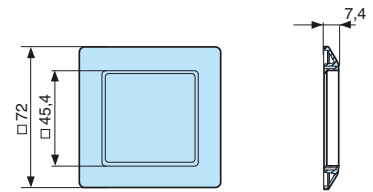

26546846 - Adaptor for 55 x 55 mm cut-out

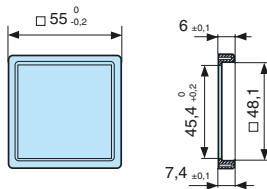

26546841 - DIN rail adaptor

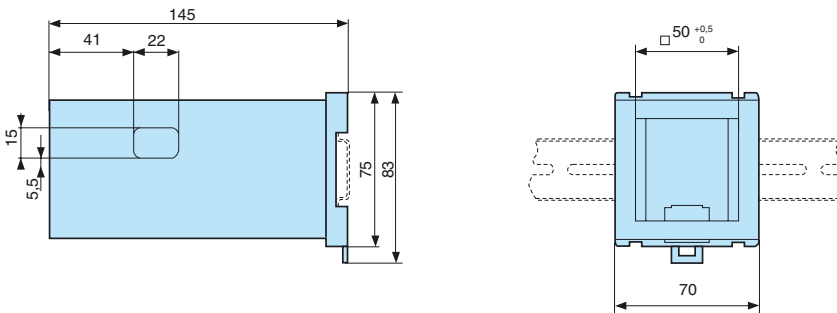

87629111

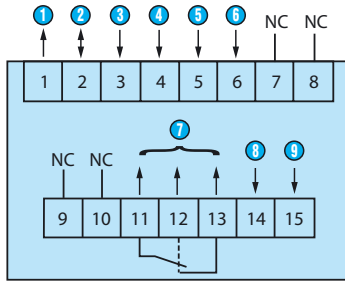

- ① Sensor voltage supply (* UB interconnected)
- ② GND (0 V₋₋₋)
- ③ INP A (signal A input)
- ④ INP B (signal B input)
- ⑤ Reset (Reset input)
- ⑥ Lock (locking switch input)
- ⑦ 11-12-13: Output 1
- ⑧ 14-15: Supply
- ⑨ Power supply - GND

87629113 / 114

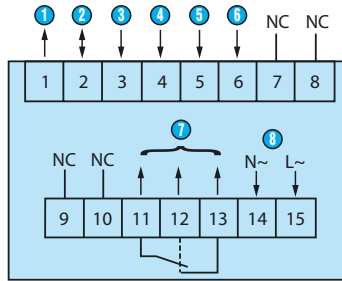

- ① Sensor voltage supply
- ② GND (0 V₋₋₋)
- ③ INP A (signal A input)
- ④ INP B (signal B input)
- ⑤ Reset (Reset input)
- ⑥ Lock (locking switch input)
- ⑦ 11-12-13: Output 1
- ⑧ 14-15: Supply

87629121

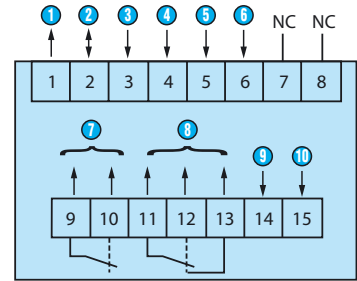

- ① Sensor voltage supply (* UB interconnected)
- ② GND (0 V₋₋₋)
- ③ INP A (signal A input)
- ④ INP B (signal B input)
- ⑤ Reset (Reset input)
- ⑥ Lock (locking switch input)
- ⑦ 9-10: Output 1
- ⑧ 11-12-13: Output 2
- ⑨ 14-15: Supply
- ⑩ Power supply - GND

87629123 / 124

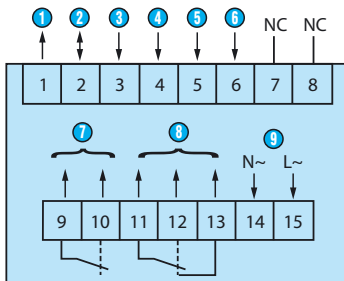

- ① Sensor voltage supply
- ② GND (0 V₋₋₋)
- ③ INP A (signal A input)
- ④ INP B (signal B input)
- ⑤ Reset (Reset input)
- ⑥ Lock (locking switch input)
- ⑦ 9-10: Output 1
- ⑧ 11-12-13: Output 2
- ⑨ 14-15: Supply

Programming diagram

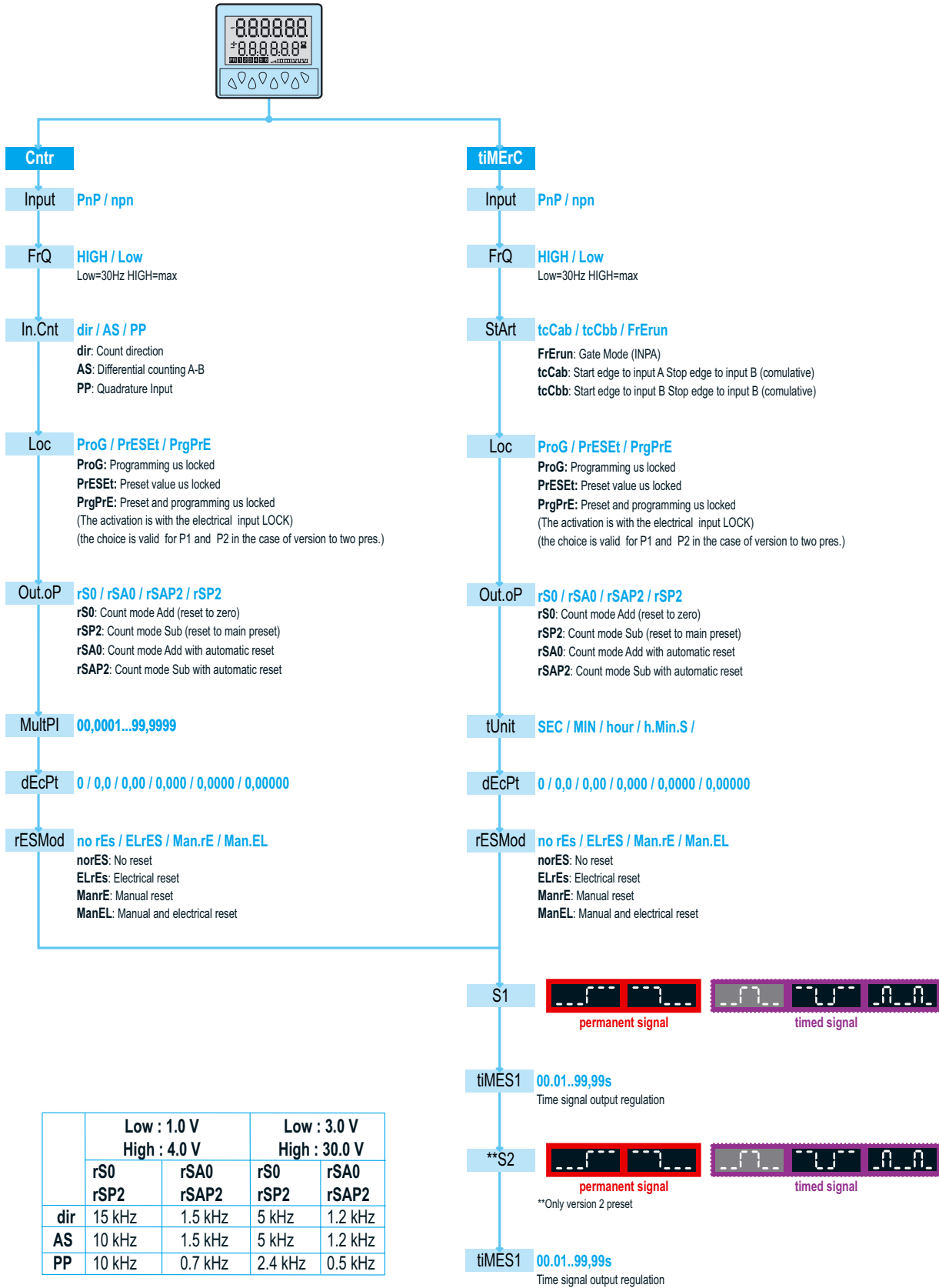

Counter: dir

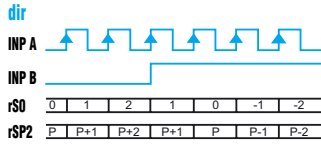

A 90° B
 Inp A: Counter input
 Counting on an edge
 Inp B: Reversal of direction
 rS0: Display 0 → Preset
 rSP2: Display Preset → 0

Chronometer: Start tcCAb

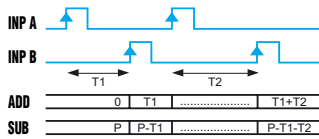

Inp A: On
 Inp B: Off
 Add: Display 0 → Preset
 Sub: Display Preset → 0

Output operation 1: rS0

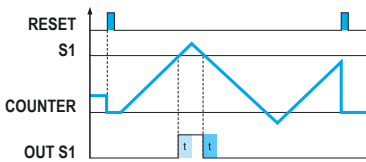

Output operation 1: rSAP2

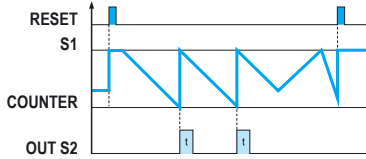

Output operation 2: rSP2

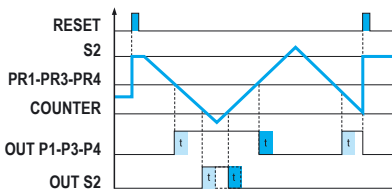

Counter: AS

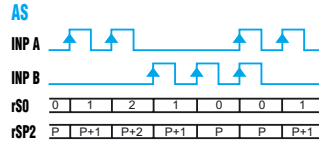

Inp A: Add. counter input 1
 Inp B: Sub. counter input 2
 rS0: Display 0 → Preset
 rSP2: Display Preset → 0

Chronometer: Start tcCbb

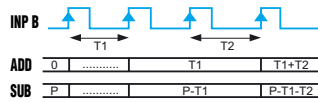

Inp A: No function
 Inp B: On/Off
 RS0/RSP2
 Add: Display 0 → Preset
 Sub: Display Preset → 0

Output operation 1: rSA0

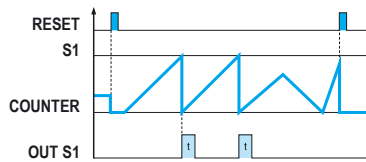

Output operation 2: rS0

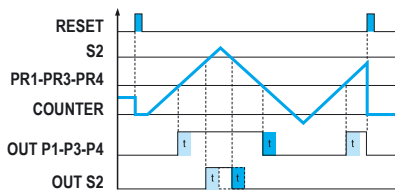

Output operation 2: rSAP2

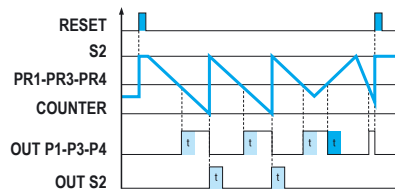

Counter: PP

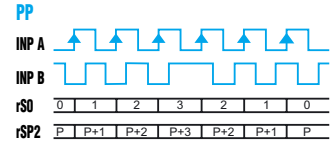

A 90° B
 Inp A: Counter input
 Counting on an edge
 Inp B: Reversal of direction
 rS0: Display 0 → Preset
 rSP2: Display Preset → 0

Chronometer: Start FrErun

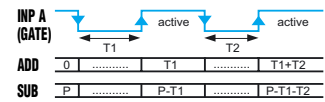

InpA: Gate
 Time measurement via InpA
 InpB: No function

Output operation 1: rSP2

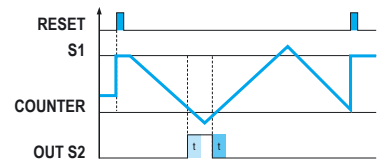

Output operation 2: rSA0

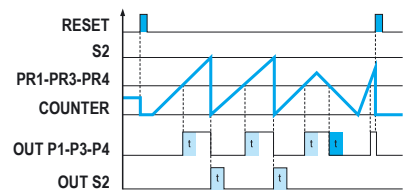

Компания «Life Electronics» занимается поставками электронных компонентов импортного и отечественного производства от производителей и со складов крупных дистрибьюторов Европы, Америки и Азии.

С конца 2013 года компания активно расширяет линейку поставок компонентов по направлению коаксиальный кабель, кварцевые генераторы и конденсаторы (керамические, пленочные, электролитические), за счёт заключения дистрибьюторских договоров

Мы предлагаем:

- Конкурентоспособные цены и скидки постоянным клиентам.
- Специальные условия для постоянных клиентов.
- Подбор аналогов.
- Поставку компонентов в любых объемах, удовлетворяющих вашим потребностям.
- Приемлемые сроки поставки, возможна ускоренная поставка.
- Доставку товара в любую точку России и стран СНГ.
- Комплексную поставку.
- Работу по проектам и поставку образцов.
- Формирование склада под заказчика.
- Сертификаты соответствия на поставляемую продукцию (по желанию клиента).
- Тестирование поставляемой продукции.
- Поставку компонентов, требующих военную и космическую приемку.
- Входной контроль качества.
- Наличие сертификата ISO.

В составе нашей компании организован Конструкторский отдел, призванный помогать разработчикам, и инженерам.

Конструкторский отдел помогает осуществить:

- Регистрацию проекта у производителя компонентов.
- Техническую поддержку проекта.
- Защиту от снятия компонента с производства.
- Оценку стоимости проекта по компонентам.
- Изготовление тестовой платы монтаж и пусконаладочные работы.



Тел: +7 (812) 336 43 04 (многоканальный)
Email: org@lifeelectronics.ru