



17 Ω, +12 V / ± 5 V / +5 V / +3 V, 8-Ch / Dual 4-Ch High Performance Analog Multiplexers

DESCRIPTION

The DG408LE, DG409LE are monolithic analog multiplexers / demultiplexers designed to operate on single and dual supplies. Single supply voltage ranges from 3 V to 16 V while dual supply operation is recommended with ± 3 V to ± 8 V.

The DG408LE is an 8 channel single-ended analog multiplexer designed to connect one of eight inputs to a common output as determined by a 3 bit binary address (A₀, A₁, A₂). The DG409LE is a dual 4 channel differential analog multiplexer designed to connect one of four differential inputs to a common dual output as determined by its 2 bit binary address (A₀, A₁). Break-before-make switching action to protect against momentary crosstalk between adjacent channels.

An on channel conducts current equally well in both directions. In the off state each channel blocks voltages up to the power supply rails. An enable (EN) function allows the user to reset the multiplexer / demultiplexer to all switches off for stacking several devices. All control inputs, address (A_x) and enable (EN) are TTL compatible over the full specified operating temperature range.

The DG408LE, DG409LE feature low on-resistance, fast switching time, and low leakage. They are ideal for data acquisition, control and automation, test instrument, and healthcare products. The DG408LE, DG409LE has an internal regulator powers the logic circuit. Such design reduces device power consumption and makes them ideal for battery operated applications.

The DG408LE, DG409LE are available in TSSOP16, SOIC16, and QFN16 packages.

FEATURES

- Pin-for-pin compatibility with DG408, DG409, and DG508, DG509
- 3 V to 16 V single supply or ± 3 V to ± 8 V dual supply operation
- Low power consumption: 6 μA/max., EN = V_X = 5 V
- Lower on-resistance: R_{DS(on)} - 17 Ω typ.
- Fast switching: t_{ON} - 55 ns, t_{OFF} - 36 ns
- Break-before-make guaranteed
- Low leakage: I_{S(OFF)} - 1 nA max.
- TTL, CMOS, LV logic (3 V) compatible
- -99 dB off-isolation and -98 dB crosstalk at 100 kHz
- Low parasitic capacitances: C_{S(OFF)} = 5.5 pF, C_{D(ON)} = 35 pF (DG408LE)
- ESD Protection:
 - ± 2.5 kV human body model
 - ± 100 V machine model
- Material categorization: for definitions of compliance please see www.vishay.com/doc?99912



Note

* This datasheet provides information about parts that are RoHS-compliant and / or parts that are non-RoHS-compliant. For example, parts with lead (Pb) terminations are not RoHS-compliant. Please see the information / tables in this datasheet for details.

BENEFITS

- High accuracy
- Single and dual power rail capacity
- Wide operating voltage range
- Simple logic interface

APPLICATIONS

- Automatic test equipment
- Data acquisition systems
- Meters and instruments
- Medical and healthcare systems
- Communication systems
- Audio and video signal routing
- Relay replacement
- Battery powered systems
- Computer peripherals
- Audio and video signal routing

FUNCTIONAL BLOCK DIAGRAMS AND PIN CONFIGURATIONS

DG408LE

Dual-In- Line, SOIC and TSSOP



DG409LE

Dual-In- Line, SOIC and TSSOP



QFN OUTLINE

TRUTH TABLE (DG408LE)				
A ₂	A ₁	A ₀	EN	ON SWITCH
X	X	X	0	None
0	0	0	1	1
0	0	1	1	2
0	1	0	1	3
0	1	1	1	4
1	0	0	1	5
1	0	1	1	6
1	1	0	1	7
1	1	1	1	8

TRUTH TABLE (DG409LE)			
A ₁	A ₀	EN	ON SWITCH
X	X	0	None
0	0	1	1
0	1	1	2
1	0	1	3
1	1	1	4

Note

- For low and high voltage levels for V_{AX} and V_{EN} consult "Digital Control" parameters for specific V₊ operation.

ORDERING INFORMATION				
TEMP. RANGE	CONFIGURATION	PACKAGE	PART NUMBER	MIN. ORDER / PACK. QUANTITY
-40 °C to +85 °C Lead-free	8 Channel Single Ended DG408LE	16-pin TSSOP	DG408LEDQ-GE3	Tube 360 units
			DG408LEDQ-T1-GE3	Tape and reel, 3000 units
		16-pin SOIC	DG408LEDY-GE3	Tube 500 units
			DG408LEDY-T1-GE3	Tape and reel, 2500 units
		16-pin QFN (3 mm x 3 mm) Variation 2	DG408LEDN-T1-GE4	Tape and reel, 2500 units
		Dual 4 Channel Differential DG409LE	16-pin TSSOP	DG409LEDQ-GE3
	DG409LEDQ-T1-GE3			Tape and reel, 3000 units
	16-pin SOIC		DG409LEDY-GE3	Tube 500 units
			DG409LEDY-T1-GE3	Tape and reel, 2500 units
	16-pin QFN (3 mm x 3 mm) Variation 2		DG409LEDN-T1-GE4	Tape and reel, 2500 units

Note

- T1 indicates tape and reel, -GE3 indicates lead (Pb)-free and RoHS-compliant, NO -GE3 indicates standard tin/lead finish.
- Exposed pad of QFN package can be connected to GND, V₋, or left floating.



ABSOLUTE MAXIMUM RATINGS			
PARAMETER		LIMIT	UNIT
V+ to V- ^e		18	V
GND to V-		-18	
Digital Inputs ^a , V _S , V _D		(V-) - 0.3 to (V) + 0.3	
Current (any terminal)		30	mA
Peak Current, S or D (pulsed at 1 ms, 10 % duty cycle max.)		100	
Storage Temperature	(D suffix)	-65 to +125	°C
Power Dissipation (package) ^b	16-pin plastic TSSOP ^c	600	mW
	16-pin narrow SOIC ^c	600	
	16-pin miniQFN ^d	1385	
ESD Human Body Model (HBM); per ANSI / ESDA / JEDEC [®] JS-001		2500	V
Latch Up Current, per JESD78D		300	mA

Notes

- a. Signals on S_x, D_x, A_x, or EN exceeding V+ or V- will be clamped by internal diodes. Limit forward diode current to maximum current ratings.
- b. All leads soldered or welded to PC board.
- c. Derate 8 mW/°C above 75 °C.
- d. Derate 17.3 mW/°C above 70 °C
- e. Also applies when V- = GND

Stresses beyond those listed under "Absolute Maximum Ratings" may cause permanent damage to the device. These are stress ratings only, and functional operation of the device at these or any other conditions beyond those indicated in the operational sections of the specifications is not implied. Exposure to absolute maximum rating conditions for extended periods may affect device reliability.



SPECIFICATIONS (Single Supply 12 V)									
PARAMETER	SYMBOL	TEST CONDITIONS UNLESS OTHERWISE SPECIFIED V+ = 12 V, ± 10 %, V- = 0 V VEN = 0.8 V or 2.4 V ^f	TEMP. ^b	TYP. ^d	D SUFFIX -40 °C to +85 °C		UNIT		
					MIN. ^c	MAX. ^c			
Analog Switch									
Analog Signal Range ^e	V _{ANALOG}		Full	-	0	12	V		
Drain-Source On-Resistance	R _{DS(on)}	V _D = 10.8 V, V _D = 2 V or 9 V, I _S = 10 mA sequence each switch on	Room	17	-	23	Ω		
			Full	-	-	27			
R _{DS(on)} Matching Between Channels ^g	ΔR _{DS}	V _D = 10.8 V, V _D = 2 V or 9 V I _S = 10 mA	Room	1	-	3	Ω		
On-Resistance Flatness	R _{FLAT(on)}		Room	3	-	6.5			
Switch Off Leakage Current ^a	I _{S(off)}	V _{EN} = 0 V, V _D = 11 V or 1 V V _S = 1 V or 11 V	Room	-	-1	1	nA		
			Full	-	-5	5			
	Room		-	-1	1				
	Full		-	-5	5				
Channel On Leakage Current ^a	I _{D(on)}	V _S = V _D = 1 V or 11 V	Room	-	-1	1			
			Full	-	-5	5			
Digital Control									
Logic High Input Voltage	V _{INH}		Full	-	2.4	-	V		
Logic Low Input Voltage	V _{INL}		Full	-	-	0.8			
Input Current ^a	I _{IN}	V _{AX} = V _{EN} = 2.4 V or 0.8 V	Full	-	-1	1	μA		
Dynamic Characteristics									
Transition Time	t _{TRANS}	V _{S1} = 8 V, V _{S8} = 0 V, (DG408LE) V _{S1b} = 8 V, V _{S4b} = 0 V, (DG409LE) see figure 2	Room	85	-	100	ns		
			Full	-	-	110			
Break-Before-Make Time	t _{OPEN}	V _{S(all)} = V _{DA} = 5 V see figure 4	Room	34	1	-	ns		
			Full	-	-	-			
Enable Turn-On Time	t _{ON(EN)}	V _{AX} = 0 V, V _{S1} = 5 V (DG408LE) V _{AX} = 0 V, V _{S1b} = 5 V (DG409LE) see figure 3	Room	55	-	72	ns		
			Full	-	-	82			
Enable Turn-Off Time	t _{OFF(EN)}		Room	36	-	47			
			Full	-	-	50			
Charge Injection ^e (DG408LE)	Q	C _L = 1 nF, V _{GEN} = 6 V, R _{GEN} = 0 Ω	Room	-11	-	-	pC		
Charge Injection ^e (DG409LE)			Room	-10	-	-			
Off Isolation ^{e, h} (DG408LE)	OIRR	f = 100 kHz, R _L = 50 Ω	Room	-99	-	-	dB		
Off Isolation ^{e, h} (DG409LE)			Room	-87	-	-			
Crosstalk ^e (DG408LE)	X _{TALK}		Room	-98	-	-			
Crosstalk ^e (DG409LE)			Room	-109	-	-			
Source Off Capacitance ^e (DG408LE)	C _{S(off)}		f = 1 MHz, V _S = 0 V, V _{EN} = 0 V	Room	5.5	-		-	pF
Source Off Capacitance ^e (DG409LE)				Room	5.5	-		-	
Drain Off Capacitance ^e (DG408LE)	C _{D(off)}	f = 1 MHz, V _D = 2.4 V, V _{EN} = 0 V	Room	25	-	-	pF		
Drain Off Capacitance ^e (DG409LE)			Room	13.5	-	-			
Drain On Capacitance (DG408LE)	C _{D(on)}	f = 1 MHz, V _D = 0 V, V _{EN} = 2.4 V (DG409LE only)	Room	35	-	-	pF		
Drain On Capacitance ^e (DG409LE)			Room	23.5	-	-			
Power Supplies									
Power Supply Range	V+			-	3	12	V		
Power Supply Current	I+	V _{EN} = V _A = 0 V or 5 V	Room	3.5	-	6	μA		

Notes

- a. Leakage parameters are guaranteed by worst case test condition and not subject to production test.
- b. Room = 25 °C, Full = as determined by the operating temperature suffix.
- c. The algebraic convention whereby the most negative value is a minimum and the most positive a maximum, is used in this data sheet.
- d. Typical values are for DESIGN AID ONLY, not guaranteed nor subject to production testing.
- e. Guaranteed by design, not subject to production test.
- f. V_{IN} = input voltage to perform proper function.
- g. ΔR_{DS(on)} = R_{DS(on)} max. - R_{DS(on)} min.
- h. Worst case isolation occurs on Channel 4 do to proximity to the drain pin.



SPECIFICATIONS (Dual Supply $V_+ = 5\text{ V}$, $V_- = -5\text{ V}$)							
PARAMETER	SYMBOL	TEST CONDITIONS UNLESS OTHERWISE SPECIFIED $V_+ = 5\text{ V}$, $\pm 10\%$, $V_- = -5\text{ V}$ $V_{EN} = 0.6\text{ V}$ or 2.4 V ^f	TEMP. ^b	TYP. ^d	D SUFFIX -40 °C to +85 °C		UNIT
					MIN. ^c	MAX. ^c	
Analog Switch							
Analog Signal Range ^e	V_{ANALOG}		Full	-	-5	5	V
Drain-Source On-Resistance	$R_{DS(on)}$	$V_D = \pm 3.5\text{ V}$, $I_S = 10\text{ mA}$ sequence each switch on	Room	15	-	25	Ω
			Full	-	-	30	
Switch Off Leakage Current ^a	$I_{S(off)}$	$V_+ = 5.5\text{ V}$, $V_- = 5.5\text{ V}$ $V_{EN} = 0\text{ V}$, $V_D = \pm 4.5\text{ V}$, $V_S = \pm 4.5\text{ V}$	Room	-	-1	1	nA
			Full	-	-5	5	
	$I_{D(off)}$		Room	-	-1	1	
			Full	-	-5	5	
Channel On Leakage Current ^a	$I_{D(on)}$	$V_+ = 5.5\text{ V}$, $V_- = -5.5\text{ V}$ $V_{EN} = 2.4\text{ V}$, $V_D = \pm 4.5\text{ V}$, $V_S = \pm 4.5\text{ V}$	Room	-	-1	1	
			Full	-	-5	5	
Digital Control							
Logic High Input Voltage	V_{INH}		Full	-	2.4	-	V
Logic Low Input Voltage	V_{INL}		Full	-	-	0.6	
Input Current ^a	I_{IN}	$V_{AX} = V_{EN} = 2.4\text{ V}$ or 0.6 V	Full	-	-1	1	μA
Dynamic Characteristics							
Transition Time	t_{TRANS}	$V_{S1} = 3.5\text{ V}$, $V_{S8} = -3.5\text{ V}$, (DG408LE) $V_{S1b} = 3.5\text{ V}$, $V_{S4b} = -3.5\text{ V}$, (DG409LE) see figure 2	Room	87	-	100	ns
			Full	-	-	120	
Break-Before-Make Time	t_{OPEN}	$V_{S(all)} = V_{DA} = 3.5\text{ V}$ see figure 4	Room	84	1	-	ns
			Full	-	-	-	
Enable Turn-On Time	$t_{ON(EN)}$	$V_{AX} = 0\text{ V}$, $V_{S1} = 3.5\text{ V}$ (DG408LE) $V_{AX} = 0\text{ V}$, $V_{S1b} = 3.5\text{ V}$ (DG409LE) see figure 3	Room	58	-	73	ns
			Full	-	-	80	
Enable Turn-Off Time	$t_{OFF(EN)}$		Room	31	-	46	
			Full	-	-	51	
Source Off Capacitance ^e (DG408LE)	$C_{S(off)}$	$f = 1\text{ MHz}$, $V_S = 0\text{ V}$, $V_{EN} = 0\text{ V}$	Room	6	-	-	pF
Source Off Capacitance ^e (DG409LE)			Room	5.5	-	-	
Drain Off Capacitance ^e (DG408LE)	$C_{D(off)}$	$f = 1\text{ MHz}$, $V_D = 0\text{ V}$, $V_{EN} = 0\text{ V}$	Room	26	-	-	
Drain Off Capacitance ^e (DG409LE)			Room	14	-	-	
Drain On Capacitance ^e (DG408LE)	$C_{D(on)}$	$f = 1\text{ MHz}$, $V_D = 0\text{ V}$, $V_{EN} = 2.4\text{ V}$	Room	36	-	-	
Drain On Capacitance ^e (DG409LE)			Room	24	-	-	

Notes

- a. Leakage parameters are guaranteed by worst case test condition and not subject to production test.
- b. Room = 25 °C, full = as determined by the operating temperature suffix.
- c. The algebraic convention whereby the most negative value is a minimum and the most positive a maximum, is used in this datasheet.
- d. Typical values are for DESIGN AID ONLY, not guaranteed nor subject to production testing.
- e. Guaranteed by design, not subject to production test.
- f. V_{IN} = input voltage to perform proper function.
- g. $\Delta R_{DS(on)} = R_{DS(on)} \text{ max.} - R_{DS(on)} \text{ min.}$
- h. Worst case isolation occurs on channel 4 do to proximity to the drain pin.



SPECIFICATIONS (Single Supply 5 V)							
PARAMETER	SYMBOL	TEST CONDITIONS UNLESS OTHERWISE SPECIFIED V+ = 5 V, ± 10 %, V- = 0 V VEN = 0.6 V or 2.4 V ^f	TEMP. ^b	TYP. ^d	D SUFFIX -40 °C to +85 °C		UNIT
					MIN. ^c	MAX. ^c	
Analog Switch							
Analog Signal Range ^e	V _{ANALOG}		Full	-	0	5	V
Drain-Source On-Resistance	R _{DS(on)}	V+ = 4.5 V, V _D or V _S = 1 V or 3.5 V, I _S = 5 mA	Room	28	-	36	Ω
			Full	-	-	41	
R _{DS(on)} Matching Between Channels ^g	ΔR _{DS}	V+ = 4.5 V, V _D = 1 V or 3.5 V, I _S = 5 mA	Room	1	-	3	Ω
On-Resistance Flatness	R _{FLAT(on)}		Room	-	-	4	
Switch Off Leakage Current ^a	I _{S(off)}	V+ = 5.5 V, V _S = 1 V or 4 V V _D = 4 V or 1 V	Room	-	-1	1	nA
	I _{D(off)}		Full	-	-5	5	
I _{D(on)}			Room	-	-1	1	
	Full		-	-5	5		
Channel On Leakage Current ^a	I _{D(on)}	V+ = 5.5 V, V _D = V _S = 1 V or 4 V sequence each switch on	Room	-	-1	1	nA
			Full	-	-5	5	
Digital Control							
Logic High Input Voltage	V _{INH}	V+ = 5 V	Full	-	2.4	-	V
Logic Low Input Voltage	V _{INL}		Full	-	-	0.6	
Input Current ^a	I _{IN}	V _{AX} = V _{EN} = 2.4 V or 0.6 V	Full	-	-1	1	μA
Dynamic Characteristics							
Transition Time	t _{TRANS}	V _{S1} = 3.5 V, V _{S8} = 0 V, (DG408LE) V _{S1b} = 3.5 V, V _{S4b} = 0 V, (DG409LE) see figure 2	Room	113	-	135	ns
			Full	-	-	165	
Break-Before-Make Time	t _{OPEN}	V _{S(all)} = V _{DA} = 3.5 V, see figure 4	Room	75	1	-	ns
			Full	-	-	-	
Enable Turn-On Time	t _{ON(EN)}	V _{AX} = 0 V, V _{S1} = 3.5 V (DG408LE) V _{AX} = 0 V, V _{S1b} = 3.5 V (DG409LE) see figure 3	Room	77	-	89	ns
			Full	-	-	110	
Enable Turn-Off Time	t _{OFF(EN)}		Room	43	-	50	
			Full	-	-	53	
Charge Injection ^e (DG408LE)	Q	C _L = 1 nF, R _{GEN} = 0 Ω, V _{GEN} = 2.5 V	Room	-2	-	-	pC
Charge Injection ^e (DG409LE)			Room	-2	-	-	
Off Isolation ^{e, h} (DG408LE)	OIRR	f = 100 kHz, R _L = 50 Ω	Room	-100	-	-	dB
Off Isolation ^{e, h} (DG409LE)			Room	-83	-	-	
Crosstalk ^e (DG408LE)	X _{TALK}		Room	-101	-	-	
Crosstalk ^e (DG409LE)			Room	-108	-	-	
Source Off Capacitance ^e (DG408LE)	C _{S(off)}	f = 1 MHz, V _S = 0 V, V _{EN} = 0 V	Room	6.5	-	-	pF
Source Off Capacitance ^e (DG409LE)			Room	6.5	-	-	
Drain Off Capacitance ^e (DG408LE)	C _{D(off)}	f = 1 MHz, V _D = 0 V, V _{EN} = 0 V	Room	30	-	-	pF
Drain Off Capacitance ^e (DG409LE)			Room	16	-	-	
Drain On Capacitance ^e (DG408LE)	C _{D(on)}	f = 1 MHz, V _D = 0 V, V _{EN} = 2.4 V	Room	40	-	-	pF
Drain On Capacitance ^e (DG409LE)			Room	26.5	-	-	

Notes

- a. Leakage parameters are guaranteed by worst case test condition and not subject to production test.
- b. Room = 25 °C, full = as determined by the operating temperature suffix.
- c. The algebraic convention whereby the most negative value is a minimum and the most positive a maximum, is used in this data sheet.
- d. Typical values are for DESIGN AID ONLY, not guaranteed nor subject to production testing.
- e. Guaranteed by design, not subject to production test.
- f. V_{IN} = input voltage to perform proper function.
- g. ΔR_{DS(on)} = R_{DS(on)} max. - R_{DS(on)} min.
- h. Worst case isolation occurs on channel 4 do to proximity to the drain pin.



SPECIFICATIONS (Single Supply 3 V)							
PARAMETER	SYMBOL	TEST CONDITIONS UNLESS OTHERWISE SPECIFIED V+ = 3 V, ± 10 %, V- = 0 V VEN = 0.4 V or 2 V ^f	TEMP. ^b	TYP. ^d	D SUFFIX -40 °C to +85 °C		UNIT
					MIN. ^c	MAX. ^c	
Analog Switch							
Analog Signal Range ^e	V _{ANALOG}		Full	-	0	3	V
Drain-Source On-Resistance	R _{DS(on)}	V+ = 2.7 V, V _D = 0.5 or 2.2 V, I _S = 5 mA	Room	63	-	80	Ω
			Full	-	-	92	
Switch Off Leakage Current ^a	I _{S(off)}	V+ = 3.3 V, V _S = 2 or 1 V, V _D = 1 or 2 V	Room	-	-1	1	nA
			Full	-	-5	5	
	I _{D(off)}		Room	-	-1	1	
			Full	-	-5	5	
Channel On Leakage Current ^a	I _{D(on)}	V+ = 3.3 V, V _D = V _S = 1 V or 2 V sequence each switch on	Room	-	-1	1	
			Full	-	-5	5	
Digital Control							
Logic High Input Voltage	V _{INH}		Full	-	2	-	V
Logic Low Input Voltage	V _{INL}		Full	-	-	0.4	
Input Current ^a	I _{IN}	V _{AX} = V _{EN} = 2.4 V or 0.4 V	Full	-	-1	1	μA
Dynamic Characteristics							
Transition Time	t _{TRANS}	V _{S1} = 1.5 V, V _{S8} = 0 V, (DG408LE) V _{S1b} = 1.5 V, V _{S4b} = 0 V, (DG409LE) see figure 2	Room	211	-	275	ns
			Full	-	-	300	
Break-Before-Make Time	t _{OPEN}	V _{S(all)} = V _{DA} = 1.5 V, see figure 4	Room	209	1	-	ns
			Full	-	-	-	
Enable Turn-On Time	t _{ON(EN)}	V _{AX} = 0 V, V _{S1} = 1.5 V (DG408LE) V _{AX} = 0 V, V _{S1b} = 1.5 V (DG409LE) see figure 3	Room	125	-	150	ns
			Full	-	-	180	
Enable Turn-Off Time	t _{OFF(EN)}	V _{AX} = 0 V, V _{S1} = 1.5 V (DG408LE) V _{AX} = 0 V, V _{S1b} = 1.5 V (DG409LE) see figure 3	Room	45	-	75	ns
			Full	-	-	95	
Charge Injection ^e (DG408LE)	Q	C _L = 1 nF, R _{GEN} = 0 Ω, V _{GEN} = 1.5 V	Room	0	-	-	pC
Charge Injection ^e (DG409LE)			Room	-0.4	-	-	
Off Isolation ^{e, h} (DG408LE)	OIRR	f = 100 kHz, R _L = 50 Ω	Room	-90	-	-	dB
Off Isolation ^{e, h} (DG409LE)			Room	-95	-	-	
Crosstalk ^e (DG408LE)	X _{TALK}	f = 100 kHz, R _L = 50 Ω	Room	-95	-	-	dB
Crosstalk ^e (DG409LE)			Room	-93	-	-	
Source Off Capacitance ^e (DG408LE)	C _{S(off)}	f = 1 MHz, V _S = 0 V, V _{EN} = 0 V	Room	7	-	-	pF
Source Off Capacitance ^e (DG409LE)			Room	7	-	-	
Drain Off Capacitance ^e (DG408LE)	C _{D(off)}	f = 1 MHz, V _D = 0 V, V _{EN} = 0 V	Room	33	-	-	pF
Drain Off Capacitance ^e (DG409LE)			Room	18	-	-	
Drain On Capacitance ^e (DG408LE)	C _{D(on)}	f = 1 MHz, V _D = 0 V, V _{EN} = 2 V	Room	43	-	-	pF
Drain On Capacitance ^e (DG409LE)			Room	28	-	-	

Notes

- a. Leakage parameters are guaranteed by worst case test condition and not subject to production test.
- b. Room = 25 °C, full = as determined by the operating temperature suffix.
- c. The algebraic convention whereby the most negative value is a minimum and the most positive a maximum, is used in this data sheet.
- d. Typical values are for DESIGN AID ONLY, not guaranteed nor subject to production testing.
- e. Guaranteed by design, not subject to production test.
- f. V_{IN} = input voltage to perform proper function.
- g. ΔR_{DS(on)} = R_{DS(on)} max. - R_{DS(on)} min.
- h. Worst case isolation occurs on channel 4 do to proximity to the drain pin.



TYPICAL CHARACTERISTICS (25 °C, unless otherwise noted)



R_{DS(on)} vs. V_D and Power Supply



R_{DS(on)} vs. V_D and Power Supply



R_{DS(on)} vs. V_D and Temperature (Dual Supply)



R_{DS(on)} vs. V_D and Temperature



Input Threshold vs. V₊ Supply Voltage



Switching Time vs. Supply Voltage

TYPICAL CHARACTERISTICS (25 °C, unless otherwise noted)



Leakage Current vs. Analog Voltage

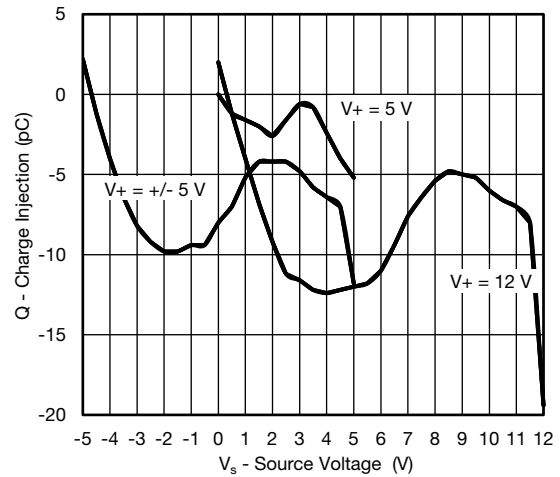

Charge Injection vs. Analog Voltage (DG408LE)



Charge Injection vs. Analog Voltage (DG409LE)

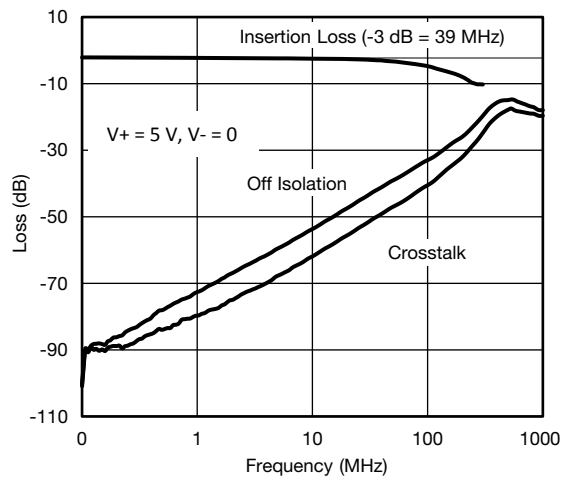

Insertion Loss, Off Isolation, and Crosstalk vs. Frequency



Drain/Source Capacitance vs. Analog Voltage (DG408LE)

SCHEMATIC DIAGRAM (Typical Channel)



Fig. 1

TEST CIRCUITS



Fig. 2 - Transition Time

TEST CIRCUITS



Fig. 3 - Enable Switching Time



Fig. 4 - Break-Before-Make Interval

TEST CIRCUITS

Fig. 5 - Charge Injection

Fig. 6 - Off Isolation

Fig. 7 - Crosstalk

Fig. 8 - Insertion Loss

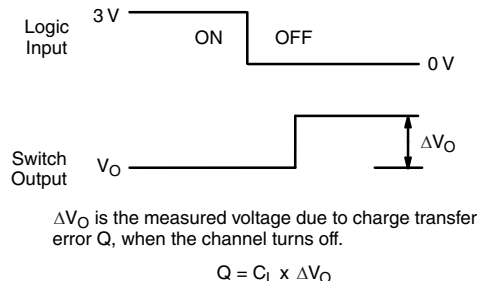
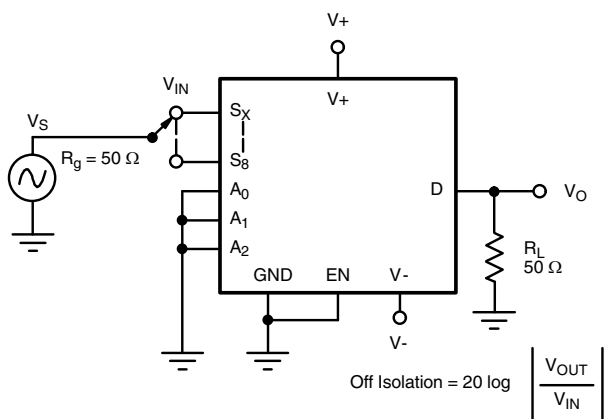
Fig. 9 - Source Drain Capacitance

Vishay Siliconix maintains worldwide manufacturing capability. Products may be manufactured at one of several qualified locations. Reliability data for Silicon Technology and Package Reliability represent a composite of all qualified locations. For related documents such as package/tape drawings, part marking, and reliability data, see www.vishay.com/ppg?78084.



SOIC (NARROW): 16-LEAD
JEDEC Part Number: MS-012



Dim	MILLIMETERS		INCHES	
	Min	Max	Min	Max
A	1.35	1.75	0.053	0.069
A ₁	0.10	0.20	0.004	0.008
B	0.38	0.51	0.015	0.020
C	0.18	0.23	0.007	0.009
D	9.80	10.00	0.385	0.393
E	3.80	4.00	0.149	0.157
e	1.27 BSC		0.050 BSC	
H	5.80	6.20	0.228	0.244
L	0.50	0.93	0.020	0.037
∅	0°	8°	0°	8°

ECN: S-03946—Rev. F, 09-Jul-01
DWG: 5300



QFN-16 Lead (3 x 3)



Notes

- (1) All dimensions are in millimeters.
- (2) N is the total number of terminals.
- (3) Dimension b applies to metallized terminal and is measured between 0.25 and 0.30 mm from terminal tip.
- (4) Coplanarity applies to the exposed heat sink slug as well as the terminal.
- (5) The pin #1 identifier may be either a mold or marked feature, it must be located within the zone indicated.

DIM.	VARIATION 1						VARIATION 2					
	MILLIMETERS			INCHES			MILLIMETERS			INCHES		
	MIN.	NOM	MAX.	MIN.	NOM	MAX.	MIN.	NOM	MAX.	MIN.	NOM	MAX.
A	0.80	0.90	1.00	0.031	0.035	0.039	0.80	0.90	1.00	0.031	0.035	0.039
b	0.18	0.23	0.30	0.007	0.009	0.012	0.18	0.25	0.30	0.007	0.010	0.012
D	2.90	3.00	3.10	0.114	0.118	0.122	2.90	3.00	3.10	0.114	0.118	0.122
D_2	1.00	1.15	1.25	0.039	0.045	0.049	1.50	1.70	1.80	0.059	0.067	0.071
E	2.90	3.00	3.10	0.114	0.118	0.122	2.90	3.00	3.10	0.114	0.118	0.122
E_2	1.00	1.15	1.25	0.039	0.045	0.049	1.50	1.70	1.80	0.059	0.067	0.071
e	0.50 BSC			0.020 BSC			0.50 BSC			0.020 BSC		
L	0.30	0.40	0.50	0.012	0.016	0.020	0.30	0.40	0.50	0.012	0.016	0.020

ECN: T16-0233-Rev. D, 09-May-16
DWG: 5899

TSSOP: 16-LEAD

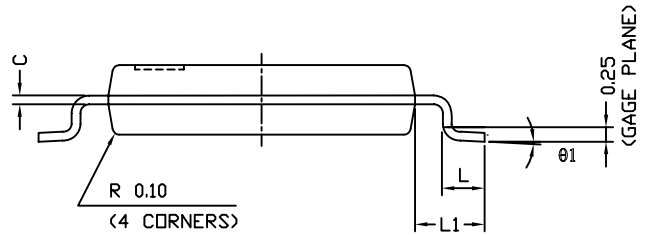
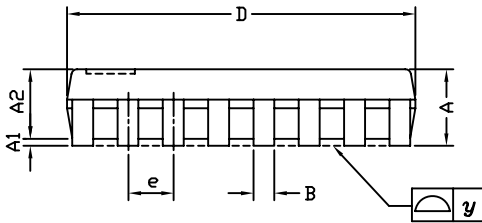
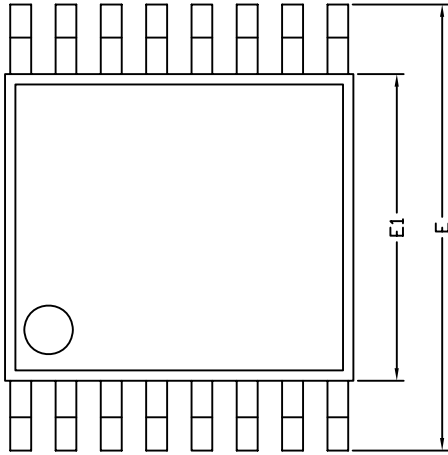

Symbols	DIMENSIONS IN MILLIMETERS		
	Min	Nom	Max
A	-	1.10	1.20
A1	0.05	0.10	0.15
A2	-	1.00	1.05
B	0.22	0.28	0.38
C	-	0.127	-
D	4.90	5.00	5.10
E	6.10	6.40	6.70
E1	4.30	4.40	4.50
e	-	0.65	-
L	0.50	0.60	0.70
L1	0.90	1.00	1.10
y	-	-	0.10
θ1	0°	3°	6°

ECN: S-61920-Rev. D, 23-Oct-06
DWG: 5624



RECOMMENDED MINIMUM PAD FOR TSSOP-16



Recommended Minimum Pads
Dimensions in inches (mm)

RECOMMENDED MINIMUM PADS FOR SO-16



Recommended Minimum Pads
Dimensions in Inches/(mm)

[Return to Index](#)



Disclaimer

ALL PRODUCT, PRODUCT SPECIFICATIONS AND DATA ARE SUBJECT TO CHANGE WITHOUT NOTICE TO IMPROVE RELIABILITY, FUNCTION OR DESIGN OR OTHERWISE.

Vishay Intertechnology, Inc., its affiliates, agents, and employees, and all persons acting on its or their behalf (collectively, "Vishay"), disclaim any and all liability for any errors, inaccuracies or incompleteness contained in any datasheet or in any other disclosure relating to any product.

Vishay makes no warranty, representation or guarantee regarding the suitability of the products for any particular purpose or the continuing production of any product. To the maximum extent permitted by applicable law, Vishay disclaims (i) any and all liability arising out of the application or use of any product, (ii) any and all liability, including without limitation special, consequential or incidental damages, and (iii) any and all implied warranties, including warranties of fitness for particular purpose, non-infringement and merchantability.

Statements regarding the suitability of products for certain types of applications are based on Vishay's knowledge of typical requirements that are often placed on Vishay products in generic applications. Such statements are not binding statements about the suitability of products for a particular application. It is the customer's responsibility to validate that a particular product with the properties described in the product specification is suitable for use in a particular application. Parameters provided in datasheets and/or specifications may vary in different applications and performance may vary over time. All operating parameters, including typical parameters, must be validated for each customer application by the customer's technical experts. Product specifications do not expand or otherwise modify Vishay's terms and conditions of purchase, including but not limited to the warranty expressed therein.

Except as expressly indicated in writing, Vishay products are not designed for use in medical, life-saving, or life-sustaining applications or for any other application in which the failure of the Vishay product could result in personal injury or death. Customers using or selling Vishay products not expressly indicated for use in such applications do so at their own risk. Please contact authorized Vishay personnel to obtain written terms and conditions regarding products designed for such applications.

No license, express or implied, by estoppel or otherwise, to any intellectual property rights is granted by this document or by any conduct of Vishay. Product names and markings noted herein may be trademarks of their respective owners.

Material Category Policy

Vishay Intertechnology, Inc. hereby certifies that all its products that are identified as RoHS-Compliant fulfill the definitions and restrictions defined under Directive 2011/65/EU of The European Parliament and of the Council of June 8, 2011 on the restriction of the use of certain hazardous substances in electrical and electronic equipment (EEE) - recast, unless otherwise specified as non-compliant.

Please note that some Vishay documentation may still make reference to RoHS Directive 2002/95/EC. We confirm that all the products identified as being compliant to Directive 2002/95/EC conform to Directive 2011/65/EU.

Vishay Intertechnology, Inc. hereby certifies that all its products that are identified as Halogen-Free follow Halogen-Free requirements as per JEDEC JS709A standards. Please note that some Vishay documentation may still make reference to the IEC 61249-2-21 definition. We confirm that all the products identified as being compliant to IEC 61249-2-21 conform to JEDEC JS709A standards.

Компания «Life Electronics» занимается поставками электронных компонентов импортного и отечественного производства от производителей и со складов крупных дистрибьюторов Европы, Америки и Азии.

С конца 2013 года компания активно расширяет линейку поставок компонентов по направлению коаксиальный кабель, кварцевые генераторы и конденсаторы (керамические, пленочные, электролитические), за счёт заключения дистрибьюторских договоров

Мы предлагаем:

- Конкурентоспособные цены и скидки постоянным клиентам.
- Специальные условия для постоянных клиентов.
- Подбор аналогов.
- Поставку компонентов в любых объемах, удовлетворяющих вашим потребностям.
- Приемлемые сроки поставки, возможна ускоренная поставка.
- Доставку товара в любую точку России и стран СНГ.
- Комплексную поставку.
- Работу по проектам и поставку образцов.
- Формирование склада под заказчика.
- Сертификаты соответствия на поставляемую продукцию (по желанию клиента).
- Тестирование поставляемой продукции.
- Поставку компонентов, требующих военную и космическую приемку.
- Входной контроль качества.
- Наличие сертификата ISO.

В составе нашей компании организован Конструкторский отдел, призванный помогать разработчикам, и инженерам.

Конструкторский отдел помогает осуществить:

- Регистрацию проекта у производителя компонентов.
- Техническую поддержку проекта.
- Защиту от снятия компонента с производства.
- Оценку стоимости проекта по компонентам.
- Изготовление тестовой платы монтаж и пусконаладочные работы.



Тел: +7 (812) 336 43 04 (многоканальный)

Email: org@lifeelectronics.ru