

U_XPRO_Extension_TEMPLATE
CryptoAuth-XPRO-B_Connector.SchDoc

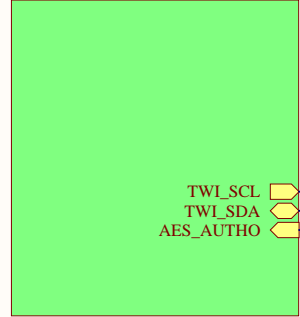

TWI_SCL
TWI_SDA
AES_AUTHO

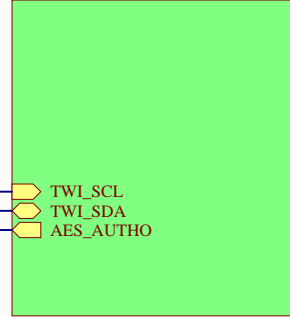

U_CryptoSheet
CryptoAuth-XPRO-B_Crypto.SchDoc

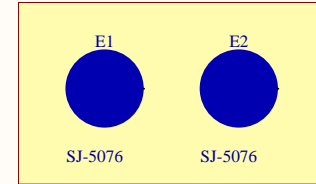

TWI_SCL
TWI_SDA
AES_AUTHO



LABEL1

 Product number/revision
 Serial number

Label PCBA

BOM Variant Component Substitution Table

VARIANT NAME	PCBA DOC	TEST DOC	TEST SFTWR
Default Assembly	A12-1291	A12-1292	A11-0394
AWS			
AZURE			

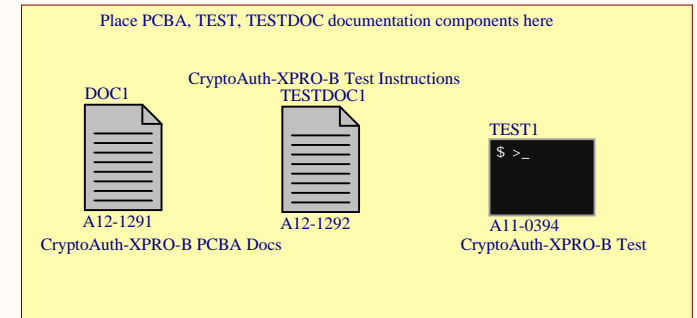
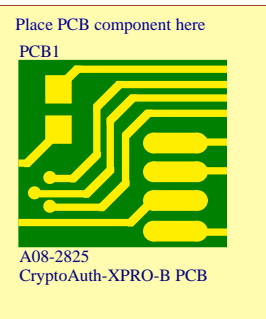

Drawn By:
Jim Boomer
Engineer:
Jim Boomer



Project Title
CryptoAuth-XPRO-B

Sheet Title
CryptoAuth-XPRO-B Top Level



Size A4	PCB Assembly Number: * PCB Number: A08-2332	PCBA Revision: 1 PCB Revision: 4	Date: 8/6/2017
File: CryptoAuth-XPRO-B_TopLevel.SchDoc			Page: 1 of 3

Extension Identification

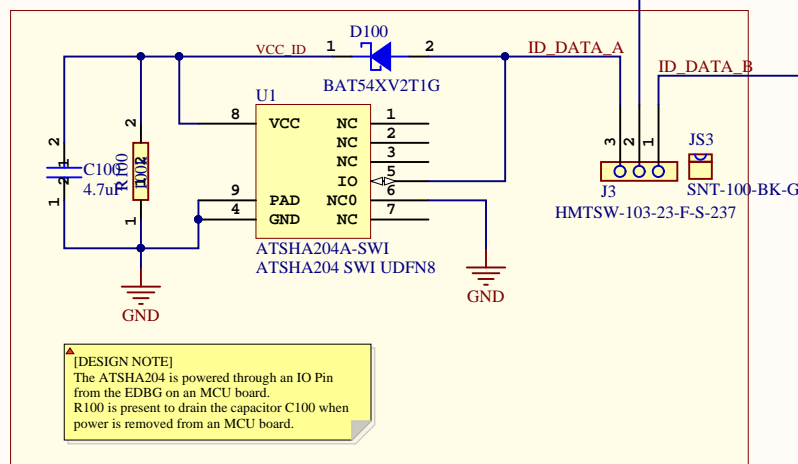

[DESIGN NOTE]
The ATSHA204 is powered through an IO Pin from the EDBG on an MCU board. R100 is present to drain the capacitor C100 when power is removed from an MCU board.

Standard Extension Header (Female)

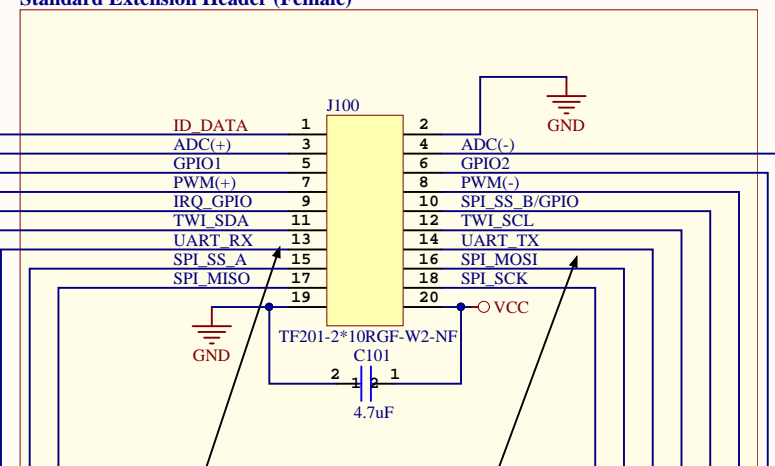

[DESIGN NOTE]
IMPORTANT NOTICE:
UART_RX and UART_TX refer to RX (input) and TX (output) at the target device side. Connect UART_RX to TX of the UART device on the extension board and UART_TX to RX of the UART device on the extension board.

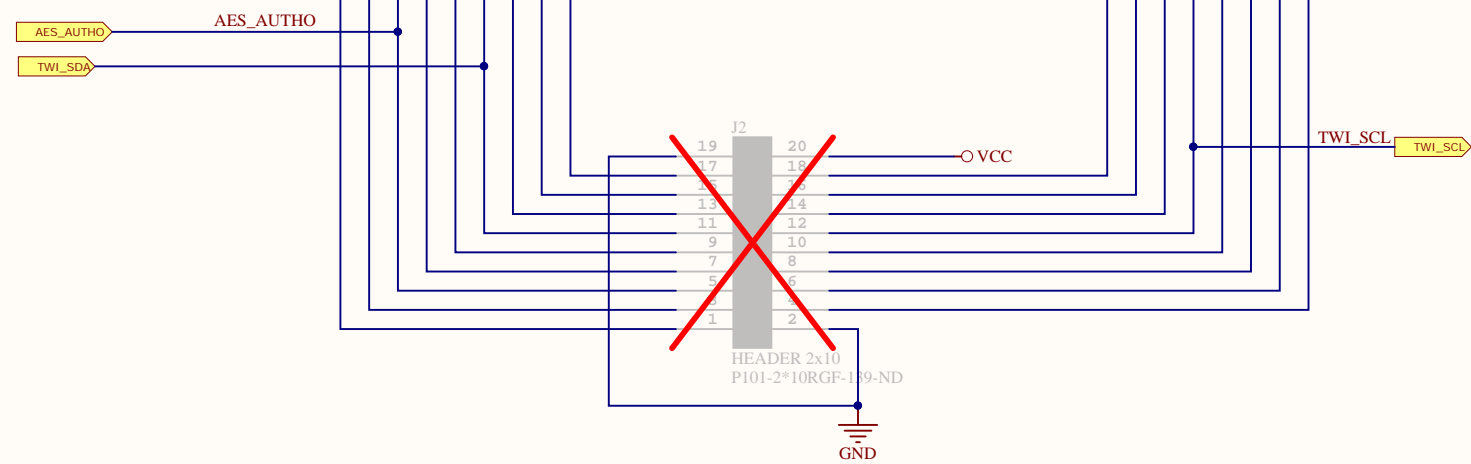

Drawn By: Jim Boomer		
Engineer: Jim Boomer		
Project Title CryptoAuth-XPRO-B Explained Pro	Designed with 	
Sheet Title CryptoAuth-XPRO Connectors	Altium.com	
Size A3	PCB Assembly Number: * A08-2332	PCBA Revision: 1
File: CryptoAuth-XPRO-B_Connector.SchDoc	PCB Number:	PCB Revision: 4
		Date: 8/6/2017
		Page: 2 of 3

If I2C Address of ECC508A and ECC608A Are the same then:
 - ECC508A = 2-4
 - ECC608A = 1-3

If I2C Address is different then both jumpers may be placed.

ATECC508A UDFN TWI

ATECC608A UDFN TWI

ATSHA204A UDFN TWI

ATAES132A UDFN TWI

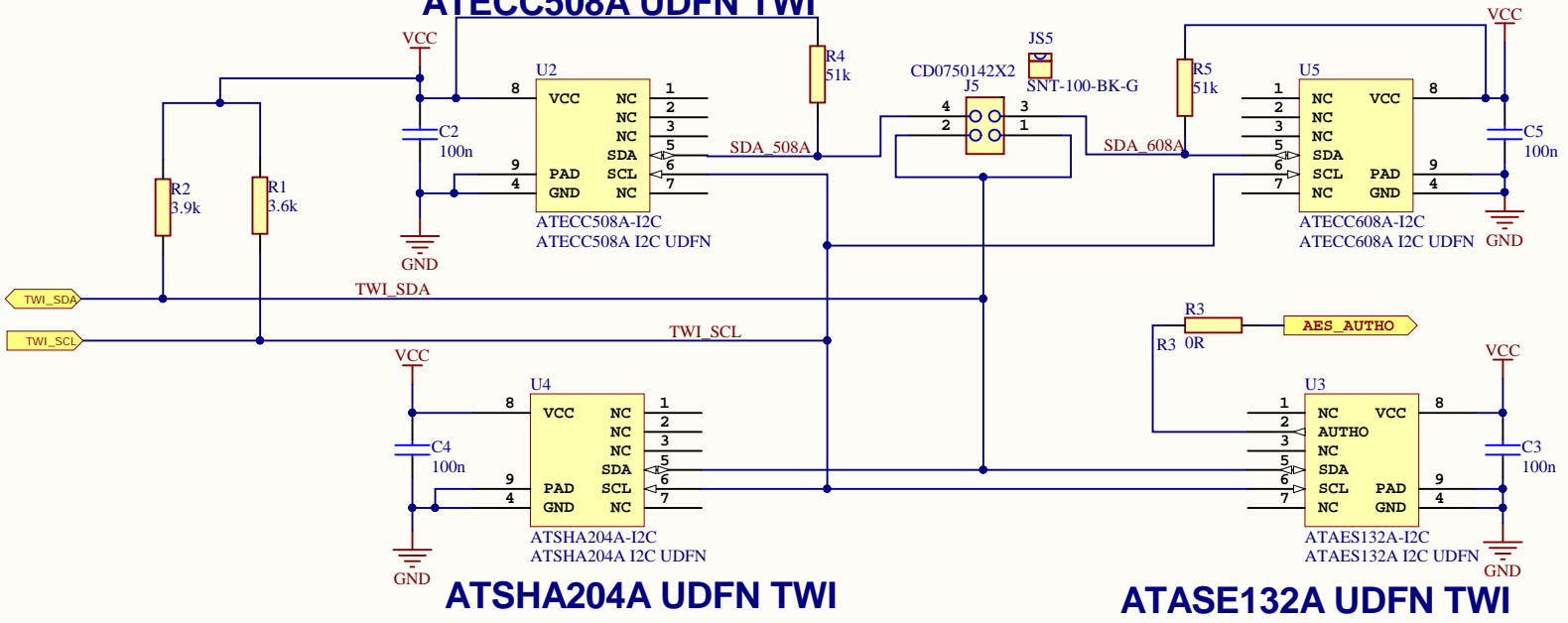

F1
FIDUCIAL
FIDUCIAL 1.5mm



F2
FIDUCIAL
FIDUCIAL 1.5mm

Drawn By:
Jim Boomer
Engineer:
Jim Boomer



Project Title
CryptoAuth-XPRO-B
Sheet Title
Crypto Device Schematic



Size A4 PCB Assembly Number: * PCB Number: A08-2332 PCBA Revision: 1 PCB Revision: 4

Date: 8/6/2017
Page: 3 of 3

2 1



C401

EXT



EXT



MICROCHIP
www.microchip.com/cryptokits
CRYPTOAUTH X PLAINED PRO

1 2

J2



Microchip Corp © 2017



12C

WAKE PULSE

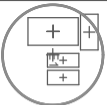

DEV ADDR	+	WAKE PULSE
AES 0xA0		NO
SHA 0xC8		YES
ECC 0xC0		YES



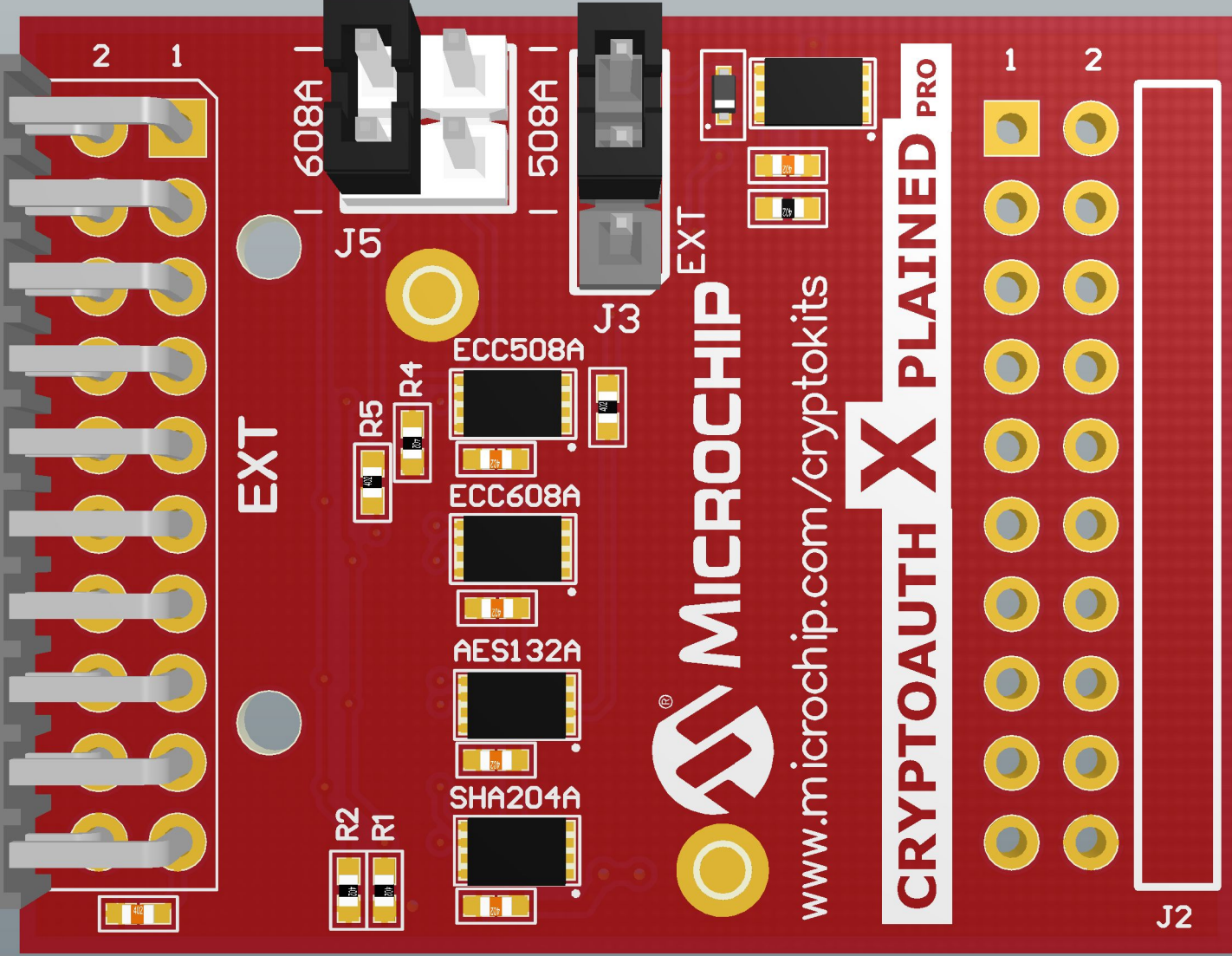

 **MICROCHIP**
www.microchip.com/cryptokits

CRYPTOAUTH X PLAINED PRO

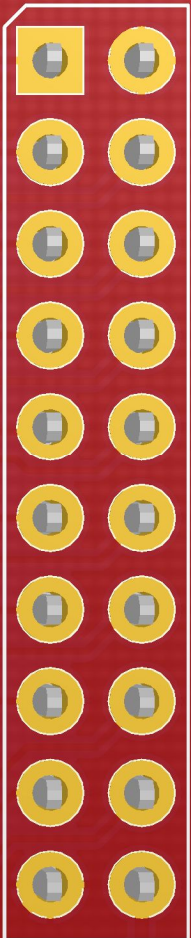

Microchip Corp © 2017

PCBA LABEL
A08-2825 Rev 1

	I2C	WAKE
DEV	ADDR	PULSE
AES	0xA0	NO
SHA	0xC8	YES
ECC	0xC0	YES

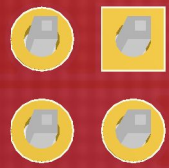
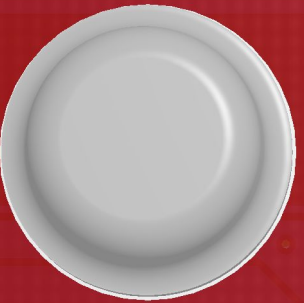
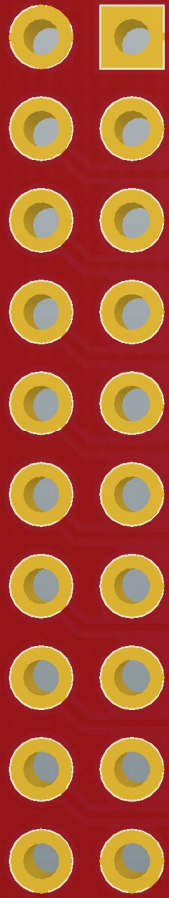



EXT



R2

R1



R5



R4



SHA204A



AES132A



ECC608A



ECC508A



J3



608A

J5



508A

J3



MICROCHIP

EXT

www.microchip.com/cryptokits

CRYPTOAUTH X PLAINED

PRO

1

2



J2

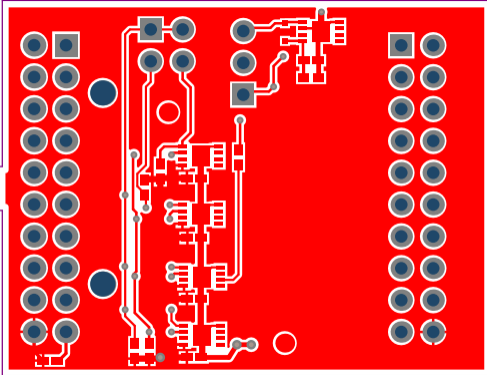

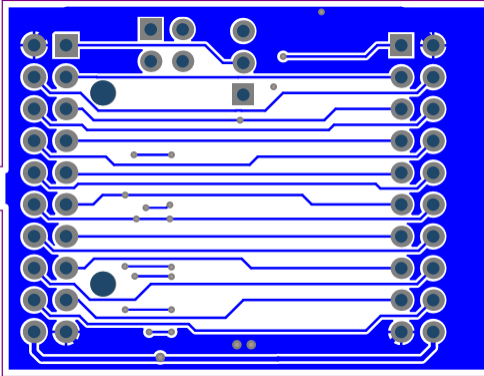



ECC	0XC0	YES
SHA	0XC8	YES
AES	0XA0	NO
DEV	ADDR	BUT SE
ISC	MAKE	



A08-S852 Rev 1
PCBA LABEL

Microchip Corp © 2012



Component list

CryptoAuth-XPRO-B Top Level

Source Data From: CryptoAuth_XPRO-B.PrjPCB
 Project: CryptoAuth_XPRO-B.PrjPCB
 Variant: NoExtHdr



Report Date: 8/6/2017 2:08:16 PM
 Print Date: 8/6/2017 1:55:58 PM

Fitted	Designator	Quantity	Value	Manufacturer	MPN	Description
Fitted	C100, C101	2	4.7uF	Murata	GRM155R60J475ME87D	Ceramic capacitor, SMD 0402, X5R, 6.3V, +/-20% (de33687)
Fitted	C2, C3, C4, C5	4	100n	Kemet	C0402C104K4RACTU	Ceramic capacitor, SMD 0402, X7R, 16V, +/-10%
Fitted	D100	1	BAT54XV2T1G	ON Semiconductor	BAT54XV2T1G	Schottky diode, If:200mA, Vf:0.35V, Vrrm:30V, SOD-523
Fitted	DOC1	1	CryptoAuth-XPRO-B PCBA Docs			CryptoAuth-XPRO-B Documentation
Fitted	E1, E2	2	SJ-5076	3M	SJ-5076	2.8mm adhesive feet, diam 8.0mm
Fitted	J100	1	TF201-2*10RGF-W2-NF	Pro-data International Corp	F201-2*10RGF-W2-NF	2x10, female pin header receptable, right-angled, 2.54mm pitch, THM, Pin In Paste
Fitted	J3	1	HMTSW-103-23-F-S-237	SAMTEC	HMTSW-103-23-F-S-237	1x3 pin header, 2.54mm pitch, Pin-in-Paste THM, 1mm hole
Fitted	J5	1	CD0750142X2	Freber	CD0750142X2	2x2 pin header, 2.54 mm pitch, Pin-in-Paste THM
Fitted	JS3	1	SNT-100-BK-G	SAMTEC	SNT-100-BK-G	Jumper cap for 2.54mm pinheader
Fitted	JS5	1	SNT-100-BK-G	SAMTEC	SNT-100-BK-G	Jumper cap for 2.54mm pinheader
Fitted	LABEL1	1	Label PCBA	ACT Logimark AS	505462	PCBA identification label PP Top White Gloss
Fitted	PCB1	1	CryptoAuth-XPRO-B PCB			CryptoAuth-XPRO-B PCB
Fitted	R1	1	3.6k			Thick film resistor, SMD 0402, 1/16W, 1%
Fitted	R100	1	100k			Thick film resistor, SMD 0402, 1/16W, 1%
Fitted	R2	1	3.9k			Thick film resistor, SMD 0402, 1/16W, 1%
Fitted	R3	1	0R	(n/a)	RMCF0402ZT0R00	RES 0.0 OHM 1/16W 0402 SMD
Fitted	R4	1	51k			Thick film resistor, SMD 0402, 1/16W, 1%
Fitted	R5	1	51k			Thick film resistor, SMD 0402, 1/16W, 1%
Fitted	TEST1	1	CryptoAuth-XPRO-B Test			Fixture test for CryptoAuth-XPRO-B
Fitted	TESTDOC1	1	CryptoAuth-XPRO-B Test Instructions			CryptoAuth-XPRO-B Test Instructions
Fitted	U1	1	ATSHA204 SW1 UDFN8	ATMEL	ATSHA204A-MAHCZ-T	ATSHA204 with 1-wire interface and UDFN8 package
Fitted	U2	1	ATECC508A I2C UDFN			ATECC508A with an I2C Interface and a 8 Pin UDFN Package with Paddle
Fitted	U3	1	ATAES132A I2C UDFN			AES132A with an I2C Interface in a UDFN Package
Fitted	U4	1	ATSHA204A I2C UDFN			ATSHA204A with and I2C Interface in the UDFN8 Pin Package with Paddle
Fitted	U5	1	ATECC608A I2C UDFN	MICROCHIP	ATECC608A-MAHDA-S	ATECC608A with an I2C Interface and a 8 Pin UDFN Package with Paddle
Not Fitted	J2	0	P101-2*10RGF-139-ND	Pro-data International Corp	P101-2*10RGF-139-ND	Pin header, 2x10, Right Angle, 2.54mm, THM, Pin In Paste

30

Approved _____ Notes _____

Компания «Life Electronics» занимается поставками электронных компонентов импортного и отечественного производства от производителей и со складов крупных дистрибьюторов Европы, Америки и Азии.

С конца 2013 года компания активно расширяет линейку поставок компонентов по направлению коаксиальный кабель, кварцевые генераторы и конденсаторы (керамические, пленочные, электролитические), за счёт заключения дистрибьюторских договоров

Мы предлагаем:

- Конкуренеспособные цены и скидки постоянным клиентам.
- Специальные условия для постоянных клиентов.
- Подбор аналогов.
- Поставку компонентов в любых объемах, удовлетворяющих вашим потребностям.
- Приемлемые сроки поставки, возможна ускоренная поставка.
- Доставку товара в любую точку России и стран СНГ.
- Комплексную поставку.
- Работу по проектам и поставку образцов.
- Формирование склада под заказчика.
- Сертификаты соответствия на поставляемую продукцию (по желанию клиента).
- Тестирование поставляемой продукции.
- Поставку компонентов, требующих военную и космическую приемку.
- Входной контроль качества.
- Наличие сертификата ISO.

В составе нашей компании организован Конструкторский отдел, призванный помогать разработчикам, и инженерам.

Конструкторский отдел помогает осуществить:

- Регистрацию проекта у производителя компонентов.
- Техническую поддержку проекта.
- Защиту от снятия компонента с производства.
- Оценку стоимости проекта по компонентам.
- Изготовление тестовой платы монтаж и пусконаладочные работы.



Тел: +7 (812) 336 43 04 (многоканальный)

Email: org@lifeelectronics.ru