



## Main

|                                    |   |
|------------------------------------|---|
| Range of product                   | Altivar 71  |
| Product or component type          | Variable speed drive  |
| Product specific application       | Complex, high-power machines  |
| Component name                     | ATV71   |
| Motor power kW                     | 3 kW at 200...240 V single phase<br>4 kW at 200...240 V 3 phases  |
| Motor power hp                     | 5 hp at 200...240 V 3 phases  |
| Motor cable length                 |   |
| [Us] rated supply voltage          | 200...240 V (- 15...10 %)   |
| Phase                              | 3 phases<br>Single phase  |
| Line current                       | 22 A for 240 V single phase 3 kW<br>22.9 A for 240 V 3 phases 4 kW / 5 hp<br>25.8 A for 200 V 3 phases 4 kW / 5 hp<br>25.9 A for 200 V 3 phases 3 kW  |
| EMC filter                         | Integrated  |
| Assembly style                     | With heat sink  |
| Apparent power                     | 9.5 kVA at 240 V 3 phases 4 kW / 5 hp<br>5.3 kVA at 240 V single phase 3 kW   |
| Prospective line Isc               | <= 5 kA, 3 phases<br><= 5 kA, single phase  |
| Nominal output current             | 13.7 A at 4 kHz 230 V 3 phases 3 kW<br>17.5 A at 4 kHz 230 V 3 phases 4 kW / 5 hp   |
| Maximum transient current          | 22.6 A for 2 s single phase 3 kW<br>26.3 A for 60 s 3 phases 4 kW / 5 hp<br>28.8 A for 2 s 3 phases 4 kW / 5 hp<br>20.6 A for 60 s 3 phases 3 kW  |
| Output frequency                   | 0.1...599 Hz  |
| Nominal switching frequency        | 4 kHz   |
| Switching frequency                | 1...16 kHz adjustable<br>4...16 kHz with derating factor  |
| Asynchronous motor control profile | ENA (Energy adaptation) system for unbalanced loads<br>Flux vector control (FVC) with sensor (current vector)<br>Sensorless flux vector control (SFVC) (voltage or current vector)<br>Voltage/frequency ratio (2 or 5 points) |
| Type of polarization               | No impedance Modbus   |

## Complementary

|                       |   |
|-----------------------|---|
| Product destination   | Asynchronous motors<br>Synchronous motors   |
| Supply voltage limits | 170...264 V   |
| Supply frequency      | 50...60 Hz (- 5...5 %)  |
| Network frequency     | 47.5...63 Hz  |
| Speed range           | 1...100 asynchronous motor in open-loop mode, without speed feedback<br>1...50 synchronous motor in open-loop mode, without speed feedback<br>1...1000 asynchronous motor in closed-loop mode with encoder feedback |
| Speed accuracy        | +/- 0.01 % of nominal speed 0.2 Tn to Tn torque variation in closed-loop mode with encoder feedback<br>+/- 10 % of nominal slip 0.2 Tn to Tn torque variation without speed feedback                                |
| Torque accuracy       | +/- 15 % in open-loop mode, without speed feedback<br>+/- 5 % in closed-loop mode with encoder feedback   |
| Transient overtorque  | 220 % of nominal motor torque +/- 10 % for 2 s<br>170 % of nominal motor torque +/- 10 % for 60 s every 10 minutes  |

The information provided in this documentation contains general descriptions and/or technical characteristics of the products contained herein. This documentation is not intended as a substitute for and is not to be used for determining suitability or reliability of these products for specific user applications. It is the duty of any such user or integrator to perform the appropriate and complete risk analysis, evaluation and testing of the products with respect to the relevant specific application or use thereof. Neither Schneider Electric Industries SAS nor any of its affiliates or subsidiaries shall be responsible or liable for misuse of the information contained herein.

|                                     |  |
|-------------------------------------|--|
| Braking torque                      | <= 150 % with braking or hoist resistor<br>30 % without braking resistor   |
| Synchronous motor control profile   | Vector control without speed feedback  |
| Regulation loop                     | Adjustable PI regulator  |
| Motor slip compensation             | Adjustable<br>Automatic whatever the load<br>Not available in voltage/frequency ratio (2 or 5 points)<br>Suppressable  |
| Local signalling                    | 1 LED red presence of drive voltage  |
| Output voltage                      | <= power supply voltage  |
| Insulation                          | Electrical between power and control   |
| Type of cable                       | With a NEMA Type1 kit: 3-strand UL 508 cableat 104 °F (40 °C), copper 75 °C PVC<br>With an IP21 or an IP31 kit: 3-strand IEC cableat 104 °F (40 °C), copper 70 °C PVC<br>Without mounting kit: 1-strand IEC cableat 113 °F (45 °C), copper 70 °C PVC<br>Without mounting kit: 1-strand IEC cableat 113 °F (45 °C), copper 90 °C XLPE/EPR     |
| Electrical connection               | AI1-/AI1+, AI2, AO1, R1A, R1B, R1C, R2A, R2B, LI1...LI6, PWR terminal 2.5 mm <sup>2</sup> / AWG 14<br>L1/R, L2/S, L3/T, U/T1, V/T2, W/T3, PC/-, PO, PA/+, PA, PB terminal 4 mm <sup>2</sup> / AWG 10   |
| Tightening torque                   | AI1-/AI1+, AI2, AO1, R1A, R1B, R1C, R2A, R2B, LI1...LI6, PWR 5.31 lbf.in (0.6 N.m)<br>L1/R, L2/S, L3/T, U/T1, V/T2, W/T3, PC/-, PO, PA/+, PA, PB 12.39 lbf.in (1.4 N.m) / 12.3 lb.in   |
| Supply                              | Internal supply for reference potentiometer (1 to 10 kOhm), 10.5 V DC +/- 5 %, <= 10 mAfor overload and short-circuit protection<br>Internal supply, 24 V DC, voltage limits 21...27 V, <= 200 mAfor overload and short-circuit protection   |
| Analogue input number               | 2  |
| Analogue input type                 | AI1-/AI1+ bipolar differential voltage +/- 10 V DC, input voltage 24 V max, resolution 11 bits + sign<br>AI2 software-configurable current 0...20 mA, impedance 242 Ohm, resolution 11 bits<br>AI2 software-configurable voltage 0...10 V DC, input voltage 24 V max, impedance 30000 Ohm, resolution 11 bits                                |
| Sampling duration                   | AI1-/AI1+ 2 ms, +/- 0.5 ms analog input(s)<br>AI2 2 ms, +/- 0.5 ms analog input(s)<br>LI1...LI5 2 ms, +/- 0.5 ms discrete input(s)<br>LI6 (if configured as logic input) 2 ms, +/- 0.5 ms discrete input(s)  |
| Response time                       | <= 100 ms in STO (Safe Torque Off)<br>AO1 2 ms, tolerance +/- 0.5 ms analog output(s)<br>R1A, R1B, R1C 7 ms, tolerance +/- 0.5 ms discrete output(s)<br>R2A, R2B 7 ms, tolerance +/- 0.5 ms discrete output(s)   |
| Accuracy                            | AI1-/AI1+ +/- 0.6 % for a temperature variation 60 °C<br>AI2 +/- 0.6 % for a temperature variation 60 °C<br>AO1 +/- 1 % for a temperature variation 60 °C  |
| Linearity error                     | AI1-/AI1+, AI2 +/- 0.15 % of maximum value<br>AO1 +/- 0.2 %  |
| Analogue output number              | 1  |
| Analogue output type                | AO1 software-configurable current 0...20 mA, impedance 500 Ohm, resolution 10 bits<br>AO1 software-configurable logic output 10 V <= 20 mA<br>AO1 software-configurable voltage 0...10 V DC, impedance 470 Ohm, resolution 10 bits   |
| Discrete output number              | 2  |
| Discrete output type                | R1A, R1B, R1C configurable relay logic NO/NC, electrical durability 100000 cycles<br>R2A, R2B configurable relay logic NO, electrical durability 100000 cycles   |
| Minimum switching current           | Configurable relay logic 3 mAat 24 V DC  |
| Maximum switching current           | R1, R2 on resistive load, 5 Aat 250 V AC, cos phi = 1,<br>R1, R2 on resistive load, 5 Aat 30 V DC, cos phi = 1,<br>R1, R2 on inductive load, 2 Aat 250 V AC, cos phi = 0.4,<br>R1, R2 on inductive load, 2 Aat 30 V DC, cos phi = 0.4,   |
| Discrete input number               | 7  |
| Discrete input type                 | LI6: switch-configurable 24 V DC with level 1 PLC, impedance: 3500 Ohm<br>PWR: safety input 24 V DC, impedance: 1500 Ohm conforming to ISO 13849-1 level d<br>LI1...LI5: programmable 24 V DC with level 1 PLC, impedance: 3500 Ohm<br>LI6: switch-configurable PTC probe 0...6, impedance: 1500 Ohm   |
| Discrete input logic                | LI1...LI5 positive logic (source), < 5 V (state 0), > 11 V (state 0)<br>LI1...LI5 negative logic (sink), > 16 V (state 0), < 10 V (state 0)<br>LI6 (if configured as logic input) positive logic (source), < 5 V (state 0), > 11 V (state 0)<br>LI6 (if configured as logic input) negative logic (sink), > 16 V (state 0), < 10 V (state 0) |
| Acceleration and deceleration ramps | Automatic adaptation of ramp if braking capacity exceeded, by using resistor   |

Linear adjustable separately from 0.01 to 9000 s  
S, U or customized

|                             |   |
|-----------------------------|---|
| Braking to standstill       | By DC injection   |
| Protection type             | Drive against exceeding limit speed<br>Drive against input phase loss<br>Drive break on the control circuit<br>Drive input phase breaks<br>Drive line supply overvoltage<br>Drive line supply undervoltage<br>Drive overcurrent between output phases and earth<br>Drive overheating protection<br>Drive overvoltages on the DC bus<br>Drive short-circuit between motor phases<br>Drive thermal protection<br>Motor motor phase break<br>Motor power removal<br>Motor thermal protection |
| Insulation resistance       | > 1 mOhm at 500 V DC for 1 minute to earth  |
| Frequency resolution        | Analog input 0.024/50 Hz<br>Display unit 0.1 Hz   |
| Communication port protocol | CANopen<br>Modbus   |
| Connector type              | 1 RJ45 Modbus on front face<br>1 RJ45 Modbus on terminal<br>Male SUB-D 9 on RJ45 CANopen  |
| Physical interface          | 2-wire RS 485 Modbus  |
| Transmission frame          | RTU Modbus  |
| Transmission rate           | 20 kbps, 50 kbps, 125 kbps, 250 kbps, 500 kbps, 1 Mbps CANopen<br>4800 bps, 9600 bps, 19200 bps, 38.4 Kbps Modbus on terminal<br>9600 bps, 19200 bps Modbus on front face   |
| Data format                 | 8 bits, 1 stop, even parity Modbus on front face<br>8 bits, odd even or no configurable parity Modbus on terminal   |
| Number of addresses         | 1...247 Modbus<br>1...127 CANopen   |
| Method of access            | Slave CANopen   |
| Marking                     | CE  |
| Operating position          | Vertical +/- 10 degree  |
| Height                      | 10.24 in (260 mm)   |
| Depth                       | 7.36 in (187 mm)  |
| Width                       | 6.1 in (155 mm)   |
| Product weight              | 8.82 lb(US) (4 kg)  |
| Functionality               | Full  |
| Specific application        | Other applications  |
| Option card                 | CC-Link communication card<br>Controller inside programmable card<br>DeviceNet communication card<br>Ethernet/IP communication card<br>Fipio communication card<br>I/O extension card<br>Interbus-S communication card<br>Interface card for encoder<br>Modbus Plus communication card<br>Modbus TCP communication card<br>Modbus/Uni-Telway communication card<br>Overhead crane card<br>Profibus DP communication card<br>Profibus DP V1 communication card                             |

## Environment

|                               |   |
|-------------------------------|---|
| noise level                   | 54.5 dB conforming to 86/188/EEC  |
| dielectric strength           | 2830 V DC between earth and power terminals<br>4230 V DC between control and power terminals  |
| electromagnetic compatibility | Conducted radio-frequency immunity test conforming to IEC 61000-4-6 level 3<br>Electrical fast transient/burst immunity test conforming to IEC 61000-4-4 level 4<br>Electrostatic discharge immunity test conforming to IEC 61000-4-2 level 3<br>Radiated radio-frequency electromagnetic field immunity test conforming to IEC 61000-4-3 level 3 |

Voltage dips and interruptions immunity test conforming to IEC 61000-4-11  
1.2/50 µs - 8/20 µs surge immunity test conforming to IEC 61000-4-5 level 3

|                                       |   |
|---------------------------------------|---|
| standards                             | EN 55011 class A group 2<br>EN 61800-3 environments 1 category C3<br>EN 61800-3 environments 2 category C3<br>EN/IEC 61800-3<br>EN/IEC 61800-5-1<br>IEC 60721-3-3 class 3C1<br>IEC 60721-3-3 class 3S2<br>UL Type 1 |
| product certifications                | CSA<br>C-Tick<br>GOST<br>NOM 117<br>UL  |
| pollution degree                      | 2 conforming to EN/IEC 61800-5-1  |
| IP degree of protection               | IP20  |
| vibration resistance                  | 1.5 mm peak to peak (f = 3...13 Hz) conforming to EN/IEC 60068-2-6<br>1 gn (f = 13...200 Hz) conforming to EN/IEC 60068-2-6   |
| shock resistance                      | 15 gn 11 ms conforming to EN/IEC 60068-2-27   |
| relative humidity                     | 5...95 % without condensation conforming to IEC 60068-2-3<br>5...95 % without dripping water conforming to IEC 60068-2-3  |
| ambient air temperature for operation | 14...122 °F (-10...50 °C) without derating  |
| ambient air temperature for storage   | -13...158 °F (-25...70 °C)  |
| operating altitude                    | <= 3280.84 ft (1000 m) without derating<br>3280.84...9842.52 ft (1000...3000 m) with current derating 1 % per 100 m   |

### Offer Sustainability

|  |  |
|--|--|
| WARNING: This product can expose you to chemicals including:   | WARNING: This product can expose you to chemicals including:   |
| Lead and lead compounds, which is known to the State of California to cause cancer and birth defects or other reproductive harm. | Lead and lead compounds, which is known to the State of California to cause cancer and birth defects or other reproductive harm. |
| Bisphenol A (BPA), which is known to the State of California to cause birth defects or other reproductive harm.                  | Bisphenol A (BPA), which is known to the State of California to cause birth defects or other reproductive harm.                  |
| For more information go to <a href="http://www.p65warnings.ca.gov">www.p65warnings.ca.gov</a>                                    | For more information go to <a href="http://www.p65warnings.ca.gov">www.p65warnings.ca.gov</a>                                    |

### Contractual warranty

|                 |           |
|-----------------|-----------|
| Warranty period | 18 months |
|-----------------|-----------|

### UL Type 1/IP 20 Drives

#### Dimensions without Option Card

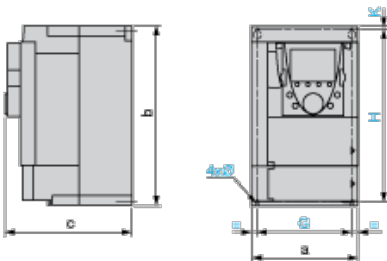

Dimensions in mm

| a   | b   | c   | G   | H   | K | Ø |
|-----|-----|-----|-----|-----|---|---|
| 155 | 260 | 187 | 138 | 249 | 4 | 5 |

Dimensions in in.

| a    | b     | c    | G    | H    | K    | Ø    |
|------|-------|------|------|------|------|------|
| 6.10 | 10.24 | 7.36 | 5.43 | 9.80 | 0.15 | 0.19 |

#### Dimensions with 1 Option Card (1)

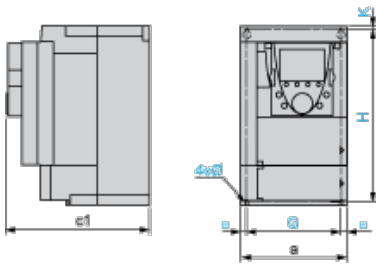

Dimensions in mm

| a   | c1  | G   | H   | K | Ø |
|-----|-----|-----|-----|---|---|
| 155 | 210 | 138 | 249 | 4 | 5 |

Dimensions in in.

| a    | c1   | G    | H    | K    | Ø    |
|------|------|------|------|------|------|
| 6.10 | 8.26 | 5.43 | 9.80 | 0.15 | 0.19 |

(1) Option cards: I/O extension cards, communication cards or "Controller Inside" programmable card.

### Dimensions with 2 Option Cards (1)

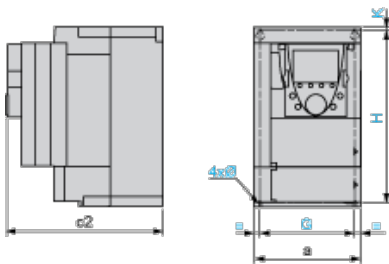

Dimensions in mm

| a   | c2  | G   | H   | K | Ø |
|-----|-----|-----|-----|---|---|
| 155 | 233 | 138 | 249 | 4 | 5 |

Dimensions in in.

| a    | c2   | G    | H    | K    | Ø    |
|------|------|------|------|------|------|
| 6.10 | 9.17 | 5.43 | 9.80 | 0.15 | 0.19 |

(1) Option cards: I/O extension cards, communication cards or "Controller Inside" programmable card.

## Mounting Recommendations

Depending on the conditions in which the drive is to be used, its installation will require certain precautions and the use of appropriate accessories.

Install the unit vertically:

- ▮ Avoid placing it close to heating elements
- ▮ Leave sufficient free space to ensure that the air required for cooling purposes can circulate from the bottom to the top of the unit.

### Clearance

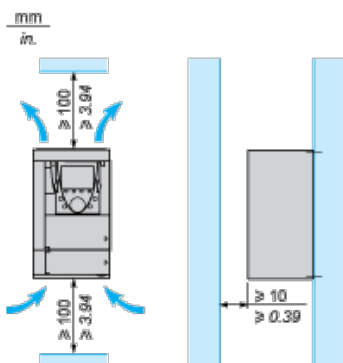

### Mounting Types

#### Type A Mounting



### Type B Mounting

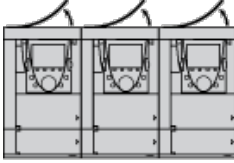

### Type C Mounting

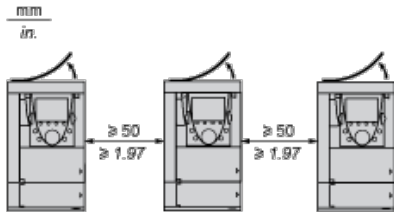

By removing the protective blanking cover from the top of the drive, the degree of protection for the drive becomes IP 20.

The protective blanking cover may vary according to the drive model (refer to the user guide).

The protective blanking cover must be removed from ATV 71P•••N4Z drives when they are mounted in a dust and damp proof enclosure.

## Specific Recommendations for Mounting the Drive in an Enclosure

### Ventilation

To ensure proper air circulation in the drive:

- 1 Fit ventilation grilles.
- 1 Ensure that there is sufficient ventilation. If there is not, install a forced ventilation unit with a filter. The openings and/or fans must provide a flow rate at least equal to that of the drive fans (refer to the product characteristics).

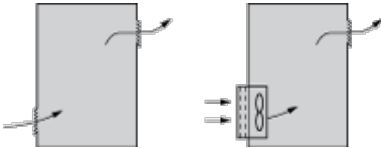

- 1 Use special filters with IP 54 protection.
- 1 Remove the blanking cover from the top of the drive.

### Dust and Damp Proof Metal Enclosure (IP 54)

The drive must be mounted in a dust and damp proof enclosure in certain environmental conditions: dust, corrosive gases, high humidity with risk of condensation and dripping water, splashing liquid, etc.

This enables the drive to be used in an enclosure where the maximum internal temperature reaches 50°C.

## Wiring Diagram Conforming to Standards EN 954-1 Category 1, IEC/EN 61508 Capacity SIL1, in Stopping Category 0 According to IEC/EN 60204-1

### Three-Phase Power Supply with Upstream Breaking via Contactor

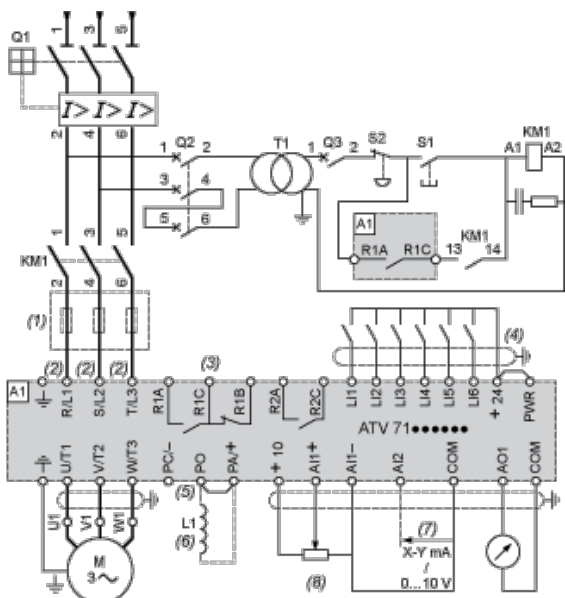

A1 ATV71 drive

KM1 Contactor

L1 DC choke

Q1 Circuit-breaker

Q2 GV2 L rated at twice the nominal primary current of T1

Q3 GB2CB05

S1, XB4 B or XB5 A pushbuttons

S2

T1 100 VA transformer 220 V secondary

(1) Line choke (three-phase); mandatory for ATV71HC11Y...HC63Y drives (except when a special transformer is used (12-pulse)).

(2) For ATV71HC40N4 drives combined with a 400 kW motor, ATV71HC50N4 and ATV71HC40Y...HC63Y, refer to the power terminal connections diagram.

(3) Fault relay contacts. Used for remote signalling of the drive status.

(4) Connection of the common for the logic inputs depends on the positioning of the SW1 switch. The above diagram shows the internal power supply switched to the "source" position (for other connection types, refer to the user guide).

(5) There is no PO terminal on ATV71HC11Y...HC63Y drives.

(6) Optional DC choke for ATV71H...M3, ATV71HD11M3X...HD45M3X, ATV71•075N4...•D75N4 and ATV71P...N4Z drives. Connected in place of the strap between the PO and PA+ terminals. For ATV71HD55M3X, HD75M3X, ATV71HD90N4...HC50N4 drives, the choke is supplied with the drive; the customer is responsible for connecting it.

(7) Software-configurable current (0...20 mA) or voltage (0...10 V) analog input.

(8) Reference potentiometer.

All terminals are located at the bottom of the drive. Fit interference suppressors on all inductive circuits near the drive or connected on the same circuit, such as relays, contactors, solenoid valves, fluorescent lighting, etc.

## Wiring Diagram Conforming to Standards EN 954-1 Category 1, IEC/EN 61508 Capacity SIL1, in Stopping Category 0 According to IEC/EN 60204-1

### Power Section for Single-Phase Power Supply

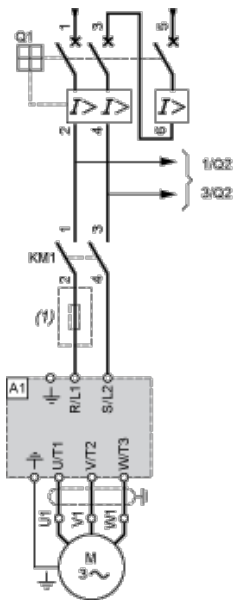

A1 ATV71 drive

KM1 Contactor

Q1 Circuit-breaker

Q2 GV2 L rated at twice the nominal primary current of T1

(1) Line Choke (single-phase); mandatory for ATV71HU40M3...HU75M3 drives with a 200...240 V 50/60 Hz single-phase power supply.

All terminals are located at the bottom of the drive. Fit interference suppressors on all inductive circuits near the drive or connected on the same circuit, such as relays, contactors, solenoid valves, fluorescent lighting, etc.

## Wiring Diagram Conforming to Standards EN 954-1 Category 1, IEC/EN 61508 Capacity SIL1, in Stopping Category 0 According to IEC/EN 60204-1

### Three-Phase Power Supply with Downstream Breaking via Switch Disconnector

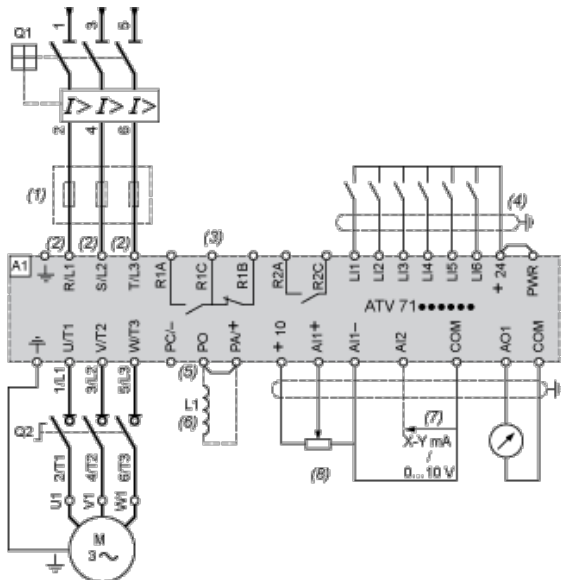

A1 ATV71 drive

L1 DC choke

Q1 Circuit-breaker

Q2 Switch disconnector (Vario)

(1) Line choke (three-phase), mandatory for ATV71HC11Y...HC63Y drives (except when a special transformer is used (12-pulse)).

(2) For ATV71HC40N4 drives combined with a 400 kW motor, ATV71HC50N4 and ATV71HC40Y...HC63Y, refer to the power terminal connections diagram.

(3) Fault relay contacts. Used for remote signalling of the drive status.

(4) Connection of the common for the logic inputs depends on the positioning of the SW1 switch. The above diagram shows the internal power supply switched to the "source" position (for other connection types, refer to the user guide).

(5) There is no PO terminal on ATV71HC11Y...HC63Y drives.

(6) Optional DC choke for ATV71H...M3, ATV71HD11M3X...HD45M3X, ATV71•075N4...•D75N4 and ATV71P...N4Z drives.



Connected in place of the strap between the PO and PA/+ terminals. For ATV71HD55M3X, HD75M3X, ATV71HD90N4...HC50N4 drives, the choke is supplied with the drive; the customer is responsible for connecting it.

- (7) Software-configurable current (0...20 mA) or voltage (0...10 V) analog input.
- (8) Reference potentiometer.

All terminals are located at the bottom of the drive. Fit interference suppressors on all inductive circuits near the drive or connected on the same circuit, such as relays, contactors, solenoid valves, fluorescent lighting, etc.

## Wiring Diagram Conforming to Standards EN 954-1 Category 1, IEC/EN 61508 Capacity SIL1, in Stopping Category 0 According to IEC/EN 60204-1

### Power Section for Single-Phase Power Supply

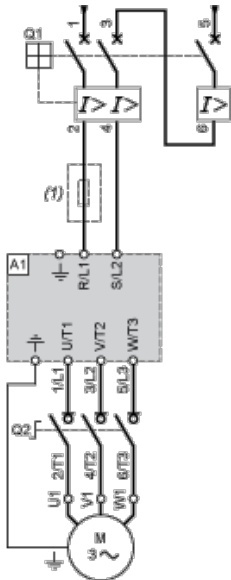

A1 ATV71 drive

Q1 Circuit-breaker

Q2 Switch disconnecter (Vario)

(1) Line Choke (single-phase); mandatory for ATV71HU40M3...HU75M3 drives with a 200...240 V 50/60 Hz single-phase power supply.

All terminals are located at the bottom of the drive. Fit interference suppressors on all inductive circuits near the drive or connected on the same circuit, such as relays, contactors, solenoid valves, fluorescent lighting, etc.

## Wiring Diagram Conforming to Standards EN 954-1 Category 3, IEC/EN 61508 Capacity SIL2, in Stopping Category 0 According to IEC/EN 60204-1

### Three-Phase Power Supply, Low Inertia Machine, Vertical Movement

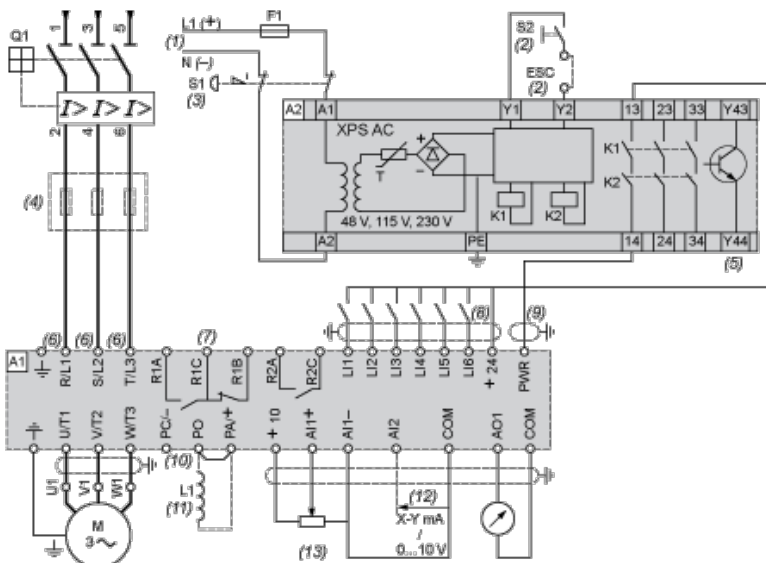

A1 ATV71 drive

A2 Preventa XPS AC safety module for monitoring emergency stops and switches. One safety module can manage the "Power Removal" function for several drives on the same machine. In this case, each drive must connect its PWR terminal to its + 24 V via

the safety contacts on the XPS AC module. These contacts are independent for each drive.

- F1 Fuse
  - L1 DC choke
  - Q1 Circuit-breaker
  - S1 Emergency stop button with 2 contacts
  - S2 XB4 B or XB5 A pushbutton
- (1) Power supply: 24 Vdc or Vac, 48 Vac, 115 Vac, 230 Vac.
  - (2) S2: resets XPS AC module on power-up or after an emergency stop. ESC can be used to set external starting conditions.
  - (3) Requests freewheel stopping of the movement and activates the "Power Removal" safety function.
  - (4) Line choke (three-phase), mandatory for and ATV71HC11Y...HC63Y drives (except when a special transformer is used (12-pulse)).
  - (5) The logic output can be used to signal that the machine is in a safe stop state.
  - (6) For ATV71HC40N4 drives combined with a 400 kW motor, ATV71HC50N4 and ATV71HC40Y...HC63Y, refer to the power terminal connections diagram.
  - (7) Fault relay contacts. Used for remote signalling of the drive status.
  - (8) Connection of the common for the logic inputs depends on the positioning of the SW1 switch. The above diagram shows the internal power supply switched to the "source" position (for other connection types, refer to the user guide).
  - (9) Standardized coaxial cable, type RG174/U according to MIL-C17 or KX3B according to NF C 93-550, external diameter 2.54 mm / 0.09 in., maximum length 15 m / 49.21 ft. The cable shielding must be earthed.
  - (10) There is no PO terminal on ATV71HC11Y...HC63Y drives.
  - (11) Optional DC choke for ATV71H...M3, ATV71HD11M3X...HD45M3X, ATV71•075N4...•D75N4 and ATV71P...N4Z drives. Connected in place of the strap between the PO and PA/+ terminals. For ATV71HD55M3X, HD75M3X, ATV71HD90N4...HC50N4 drives, the choke is supplied with the drive; the customer is responsible for connecting it.
  - (12) Software-configurable current (0...20 mA) or voltage (0...10 V) analog input.
  - (13) Reference potentiometer.

All terminals are located at the bottom of the drive. Fit interference suppressors on all inductive circuits near the drive or connected on the same circuit, such as relays, contactors, solenoid valves, fluorescent lighting, etc.

## Wiring Diagram Conforming to Standards EN 954-1 Category 3, IEC/EN 61508 Capacity SIL2, in Stopping Category 0 According to IEC/EN 60204-1

### Power Section for Single-Phase Power Supply

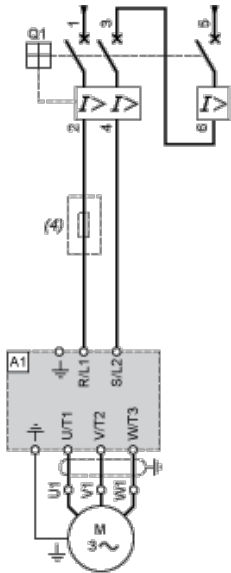

- A1 ATV71 drive
  - Q1 Circuit-breaker
- (4) Line Choke (single-phase); mandatory for ATV71HU40M3...HU75M3 drives with a 200...240 V 50/60 Hz single-phase power supply.

All terminals are located at the bottom of the drive. Fit interference suppressors on all inductive circuits near the drive or connected on the same circuit, such as relays, contactors, solenoid valves, fluorescent lighting, etc.

## Wiring Diagram Conforming to Standards EN 954-1 Category 3, IEC/EN 61508 Capacity SIL2, in Stopping Category 1 According to IEC/EN 60204-1

### Three-Phase Power Supply, High Inertia Machine

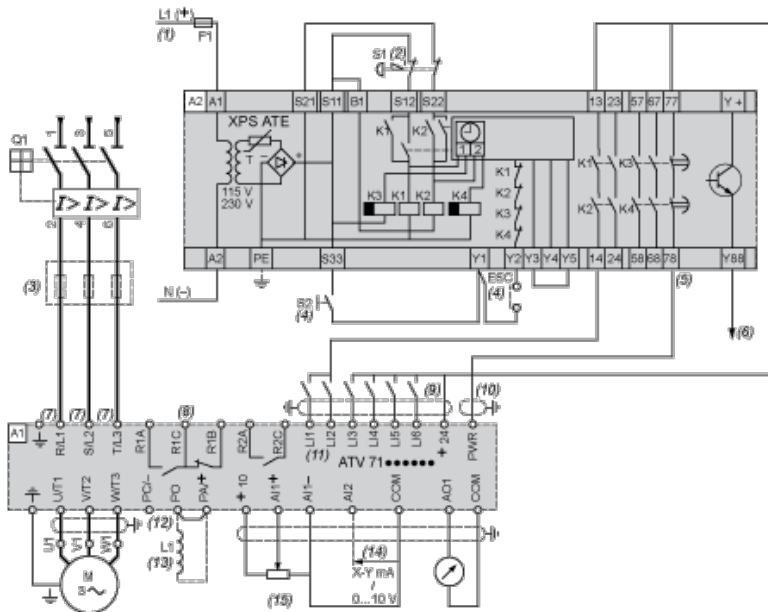

- A1 ATV71 drive
- A2 Preventa XPS ATE safety module for monitoring emergency stops and switches. One safety module can manage the "Power Removal" safety function for several drives on the same machine. In this case the time delay must be adjusted on the drive controlling the motor that requires the longest stopping time. In addition, each drive must connect its PWR terminal to its + 24 V via the safety contacts on the XPS ATE module. These contacts are independent for each drive.
- (5) Removal" safety function for several drives on the same machine. In this case the time delay must be adjusted on the drive controlling the motor that requires the longest stopping time. In addition, each drive must connect its PWR terminal to its + 24 V via the safety contacts on the XPS ATE module. These contacts are independent for each drive.
- F1 Fuse
- L1 DC choke
- Q1 Circuit-breaker
- S1 Emergency stop button with 2 N/C contacts
- S2 Run button
- (1) Power supply: 24 Vdc or Vac, 115 Vac, 230 Vac.
- (2) Requests controlled stopping of the movement and activates the "Power Removal" safety function.
- (3) Line choke (three-phase), mandatory for ATV71HC11Y...HC63Y drives (except when a special transformer is used (12-pulse)).
- (4) S2: resets XPS ATE module on power-up or after an emergency stop. ESC can be used to set external starting conditions.
- (5) For stopping times requiring more than 30 seconds in category 1, use a Preventa XPS AV safety module which can provide a maximum time delay of 300 seconds.
- (6) The logic output can be used to signal that the machine is in a safe state.
- (7) For ATV71HC40N4 drives combined with a 400 kW motor, ATV71HC50N4 and ATV71HC40Y...HC63Y, refer to the power terminal connections diagram.
- (8) Fault relay contacts. Used for remote signalling of the drive status.
- (9) Connection of the common for the logic inputs depends on the positioning of the SW1 switch. The above diagram shows the internal power supply switched to the "source" position (for other connection types, refer to the user guide).
- (10) Standardized coaxial cable, type RG174/U according to MIL-C17 or KX3B according to NF C 93-550, external diameter 2.54 mm/0.09 in., maximum length 15 m/49.21 ft. The cable shielding must be earthed.
- (11) Logic inputs LI1 and LI2 must be assigned to the direction of rotation: LI1 in the forward direction and LI2 in the reverse direction.
- (12) There is no PO terminal on ATV71HC11Y...HC63Y drives.
- (13) Optional DC choke for ATV71H...M3, ATV71HD11M3X...HD45M3X, ATV71•075N4...•D75N4 and ATV71P...N4Z drives. Connected in place of the strap between the PO and PA/+ terminals. For ATV71HD55M3X, HD75M3X, ATV71HD90N4...HC50N4 drives, the choke is supplied with the drive; the customer is responsible for connecting it.
- (14) Software-configurable current (0...20 mA) or voltage (0...10 V) analog input.
- (15) Reference potentiometer.

All terminals are located at the bottom of the drive. Fit interference suppressors on all inductive circuits near the drive or connected on the same circuit, such as relays, contactors, solenoid valves, fluorescent lighting, etc.

## Wiring Diagram Conforming to Standards EN 954-1 Category 3, IEC/EN 61508 Capacity SIL2, in Stopping Category 1 According to IEC/EN 60204-1

### Power Section for Single-Phase Power Supply

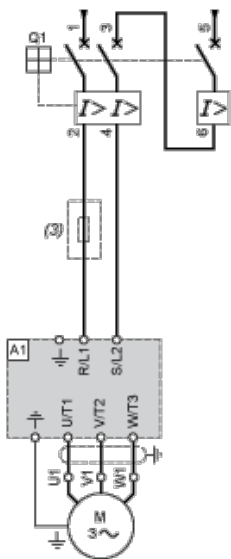

A1 ATV71 drive

Q1 Circuit-breaker

(3) Line Choke (single-phase); mandatory for ATV71HU40M3...HU75M3 drives with a 200...240 V 50/60 Hz single-phase power supply.

All terminals are located at the bottom of the drive. Fit interference suppressors on all inductive circuits near the drive or connected on the same circuit, such as relays, contactors, solenoid valves, fluorescent lighting, etc.

## Derating Curves

The derating curves for the drive nominal current ( $I_n$ ) depend on the temperature, the switching frequency and the mounting type. For intermediate temperatures (e.g. 55°C), interpolate between 2 curves.

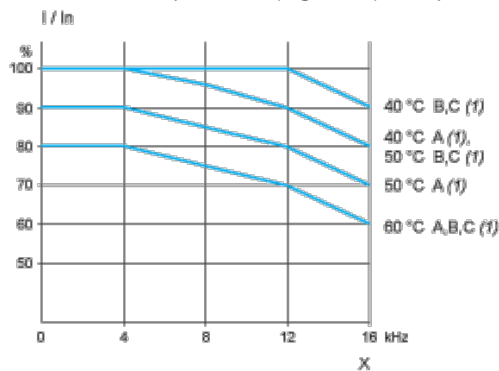

X Switching frequency

(f) Mounting type

Компания «Life Electronics» занимается поставками электронных компонентов импортного и отечественного производства от производителей и со складов крупных дистрибьюторов Европы, Америки и Азии.

С конца 2013 года компания активно расширяет линейку поставок компонентов по направлению коаксиальный кабель, кварцевые генераторы и конденсаторы (керамические, пленочные, электролитические), за счёт заключения дистрибьюторских договоров

Мы предлагаем:

- Конкурентоспособные цены и скидки постоянным клиентам.
- Специальные условия для постоянных клиентов.
- Подбор аналогов.
- Поставку компонентов в любых объемах, удовлетворяющих вашим потребностям.
- Приемлемые сроки поставки, возможна ускоренная поставка.
- Доставку товара в любую точку России и стран СНГ.
- Комплексную поставку.
- Работу по проектам и поставку образцов.
- Формирование склада под заказчика.
- Сертификаты соответствия на поставляемую продукцию (по желанию клиента).
- Тестирование поставляемой продукции.
- Поставку компонентов, требующих военную и космическую приемку.
- Входной контроль качества.
- Наличие сертификата ISO.

В составе нашей компании организован Конструкторский отдел, призванный помогать разработчикам, и инженерам.

Конструкторский отдел помогает осуществить:

- Регистрацию проекта у производителя компонентов.
- Техническую поддержку проекта.
- Защиту от снятия компонента с производства.
- Оценку стоимости проекта по компонентам.
- Изготовление тестовой платы монтаж и пусконаладочные работы.



Тел: +7 (812) 336 43 04 (многоканальный)  
Email: [org@lifeelectronics.ru](mailto:org@lifeelectronics.ru)