

## Multi Power Supply IC with Amplifier for LCD

NO.EA-301-160107

### OUTLINE

The R1293K is a multi power supply IC dedicated for mid-size TFT LCD panels. The R1293K consists of a PWM control step-up DC/DC converter, an LDO regulator, a VCOM amplifier and six GAMMA amplifiers. The output noise can be reduced by SEL pin. (SEL pin "H": normal mode, SEL pin "L": low noise mode.) The MOSFET for step-up DC/DC converter is built-in and, low power operation is realized by standby mode. The package is 4mm square QFN(PLP)0404-32.

### FEATURES

#### Step-up DC/DC converter part

- Input Voltage Range ..... 2.2V to 5.5V ( $V_{IN\_DC}$  pin)
- Adjustable Output Voltage Range with external resistors ..... up to 16V
- Feedback Voltage ..... 1.0V
- Feedback Voltage Accuracy .....  $\pm 1.5\%$
- Adjustable Oscillator Frequency with external resistors for RT pin ..... 300kHz to 1MHz
- Adjustable Phase compensation with external components
- Internal Soft Start Time ..... TYP. 10ms
- Adjustable Soft Start Time with external capacitors for DTC pin
- Oscillator Maximum Duty Cycle ..... Set with external resistors for

#### DTC pin (Limit TYP. 90%)

- UVLO detector threshold ..... TYP. 1.9V
- Internal 2A /16V capability Nch MOSFET Driver ..... TYP. 0.2 $\Omega$
- Built-in Peak Current Limit Circuit
- Short Protection with timer latch function (Adjustable delay time with external capacitors for  $D_{DELAY}$  pin)

#### LDO part

- Input Voltage Range ..... 2.2V to 5.5V ( $V_{IN\_LDO}$  pin)
- Output Voltage Range ..... 1.8V to 2.5V (Selectable / 0.1V Step)
- Output Voltage Accuracy .....  $\pm 1.0\%$
- Maximum Output Current ..... Min. 350mA guaranteed
- Ripple Rejection ..... TYP. 65db (Frequency = 1kHz)
- Built-in Fold-back Protection Circuit ..... TYP. 70mA (Current at short mode)

#### Buffer Amplifier part

- Input Voltage Range for Amplifiers ..... 5V to 16V ( $V_{BUFF}$  pin)
- Output Current Range for VCOM Amplifier ..... -100mA to 100mA
- Output Current Range for GAMMA Amplifier ..... -10mA to 10mA

#### Others

- Built-in Thermal Shutdown Circuit
- Stand-by function by ENB pin
- Package ..... QFN(PLP)0404-32

### APPLICATIONS

- Power sources of the medium and small sized TFT LCD panels

**BLOCK DIAGRAM**

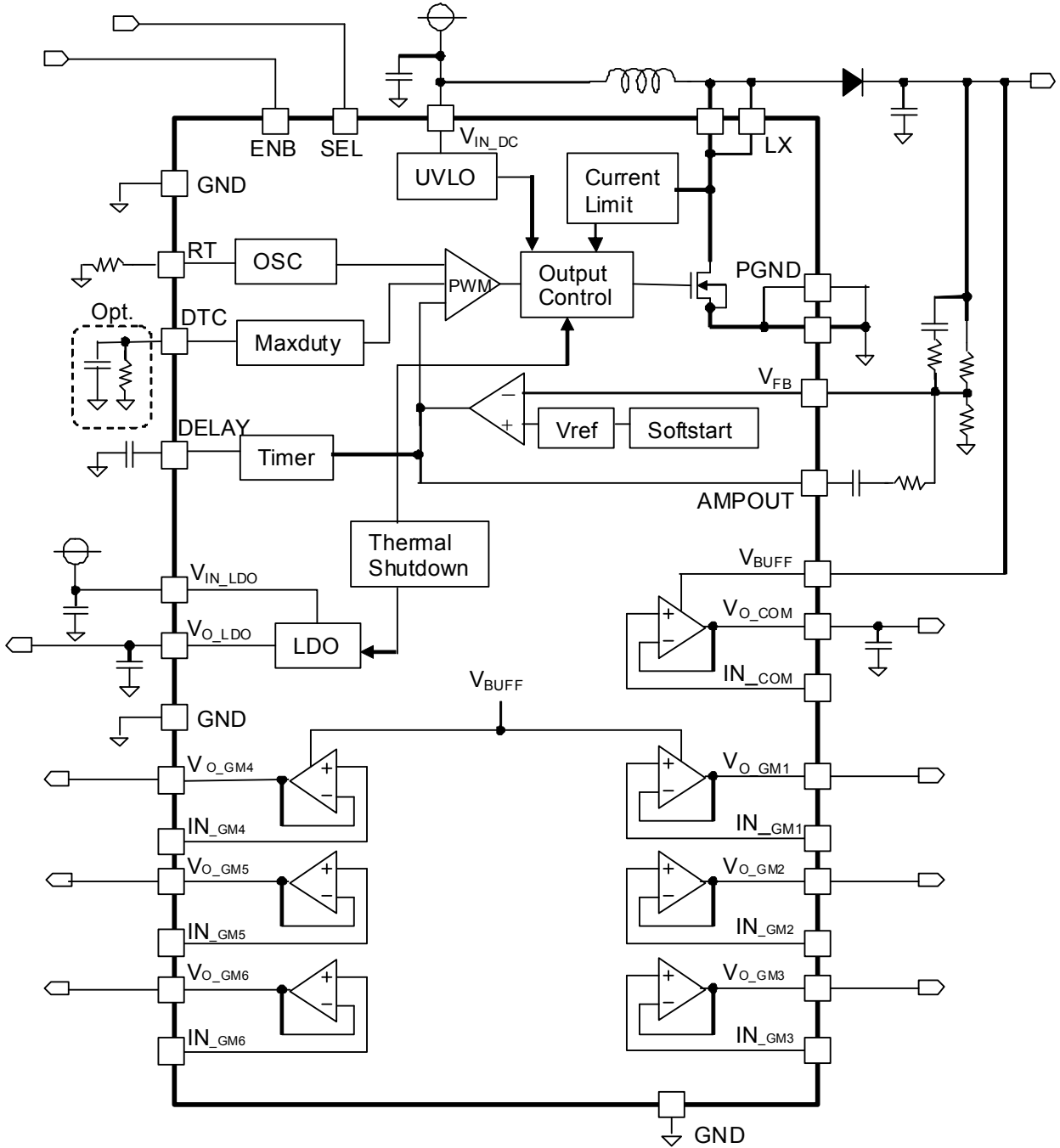

R1293K Block Diagram

## SELECTION GUIDE

The output voltage ( $V_{OUT}$ ) for the ICs is a user-selectable option.

### Selection Guide

Product Name	Package	Quantity per Reel	Pb Free	Halogen Free
R1293Kxx1A-E2	QFN(PLP)0404-32	2,000 pcs	Yes	Yes

xx: Designation of the LDO output voltage ( $V_{OUT}$ )

$V_{OUT}$  can be set within the range of 1.8 V to 2.5 V in 0.1 V steps.

## PIN CONFIGURATION

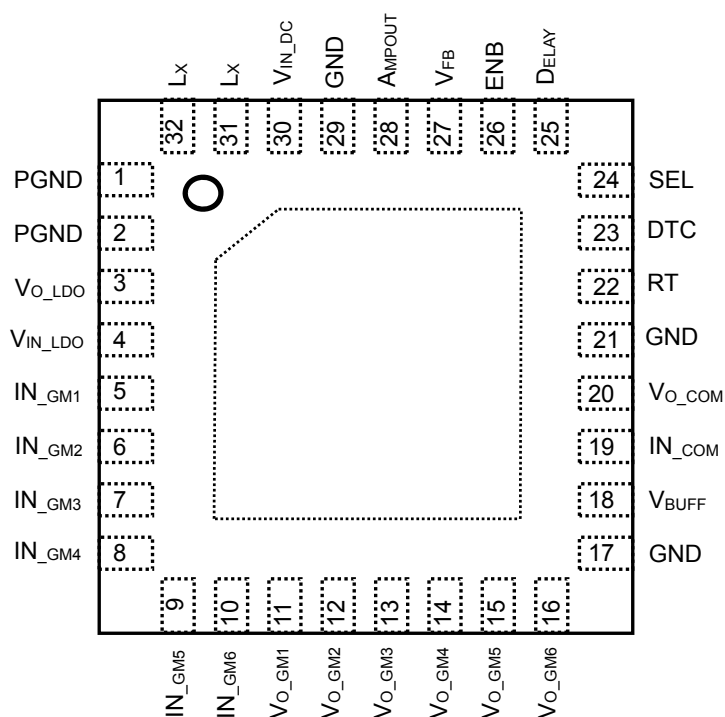

QFN(PLP)0404-32 Pin Configuration

---

**R1293K**

---

NO.EA-301-160107

**PIN DESCRIPTIONS****R1293K Pin Description**

Pin No	Symbol	Description	Notes
1	PGND	Power GND Pin	Make the PGND pin a short-circuit with the GND pin.
2	PGND	Power GND Pin	Make the PGND pin a short-circuit with the GND pin.
3	V <sub>O_LDO</sub>	LDO Output Pin	
4	V <sub>IN_LDO</sub>	LDO Power Input Pin	Input 2.2V to 5.5V to V <sub>IN_LDO</sub> . Make V <sub>IN_LDO</sub> a short-circuit with the V <sub>IN_DC</sub> pin.
5	IN <sub>GM1</sub> *1	GAMMA1 Input Pin	
6	IN <sub>GM2</sub> *1	GAMMA2 Input Pin	
7	IN <sub>GM3</sub> *1	GAMMA3 Input Pin	
8	IN <sub>GM4</sub> *1	GAMMA4 Input Pin	
9	IN <sub>GM5</sub> *1	GAMMA5 Input Pin	
10	IN <sub>GM6</sub> *1	GAMMA6 Input Pin	
11	V <sub>O_GM1</sub>	GAMMA1 Output Pin	
12	V <sub>O_GM2</sub>	GAMMA2 Output Pin	
13	V <sub>O_GM3</sub>	GAMMA3 Output Pin	
14	V <sub>O_GM4</sub>	GAMMA4 Output Pin	
15	V <sub>O_GM5</sub>	GAMMA5 Output Pin	
16	V <sub>O_GM6</sub>	GAMMA6 Output Pin	
17	GND	GND Pin	
18	V <sub>BUFF</sub>	Buffer Amplifier Power Source Pin	Connect the V <sub>BUFF</sub> pin to Boost Output.
19	IN <sub>COM</sub> *1	VCOM Input Pin	
20	V <sub>O_COM</sub>	VCOM Output Pin	
21	GND	GND Pin	
22	RT	Oscillator Frequency Setting Pin	Connect a resistor to the RT pin to set the operation frequency.
23	DTC	Maxduty/ Soft-start Time Setting Pin	By adding a resistor, the Maxduty limit can be set; otherwise the Maxduty limit will be the preset value set inside the ICs. By adding a capacitor, Maxduty can start from 0 which means startup-time can be set longer.
24	SEL*1	Noise Reduction Level Selection Pin	“L” Input: Low Noise Mode “H” Input: Normal Mode

Pin No	Symbol	Description	Notes
25	DELAY	Short-circuit Protection Delay Time Setting Pin	By adding a capacitor, the DELAY pin can set a protection delay time.
26	ENB* <sup>1</sup>	Chip Enable Pin (DC/DC or Buffer Amplifier)	“L” Input: Active
27	V <sub>FB</sub>	DC/ DC Feedback Pin	
28	AMPOUT	DC/ DC Phase Compensation Pin	
29	GND	GND Pin	
30	V <sub>IN_DC</sub>	DC/ DC Power Source Pin	Input voltage should be 2.2V to 5.5V. Make the V <sub>IN_DC</sub> pin a short-circuit with the V <sub>IN_LDO</sub> pin.
31	L <sub>X</sub>	DC/ DC Switching Pin	
32	L <sub>X</sub>	DC/ DC Switching Pin	

The exposed tab on the bottom of the package enhances thermal performance and is electrically connected to GND(substrate level). It is recommended that the exposed tab be connected to the ground plane on the board otherwise be left open.

\*<sup>1</sup> Do not leave the IN<sub>GM1</sub> to IN<sub>GM6</sub>, IN<sub>COM</sub>, SEL and ENB pins open.

## R1293K

NO.EA-301-160107

### ABSOLUTE MAXIMUM RATINGS

#### Absolute Maximum Ratings

(GND = PGND = 0 V)

Symbol	Item	Rating	Unit
V <sub>IN_DC</sub>	V <sub>IN_DC</sub> Pin Voltage	-0.3 to 6.5	V
V <sub>IN_LDO</sub>	V <sub>IN_LDO</sub> Pin Voltage	-0.3 to 6.5	V
V <sub>BUFF</sub>	V <sub>BUFF</sub> Pin Voltage	-0.3 to 24	V
V <sub>RT</sub>	RT Pin Voltage	-0.3 to 4.0	V
V <sub>DTC</sub>	DTC Pin Voltage	-0.3 to 4.0	V
V <sub>FB</sub>	V <sub>FB</sub> Pin Voltage	-0.3 to 4.0	V
V <sub>AMP</sub>	AMPOUT Pin Voltage	-0.3 to 4.0	V
V <sub>DELAY</sub>	DELAY Pin Voltage	-0.3 to 4.0	V
V <sub>SEL</sub>	SEL Pin Voltage	-0.3 to 6.5	V
V <sub>ENB</sub>	ENB Pin Voltage	-0.3 to 6.5	V
V <sub>LX</sub>	Lx Pin Voltage	-0.3 to 24	V
V <sub>O_LDO</sub>	V <sub>O_LDO</sub> Pin Output Voltage	-0.3 to V <sub>IN_LDO</sub> +0.3	V
I <sub>O_LDO</sub>	V <sub>O_LDO</sub> Pin Output Current	450	mA
V <sub>IN_BUFF</sub>	Buffer Amplifier Input Voltage	-0.3 to V <sub>BUFF</sub> +0.3	V
V <sub>O_BUFF</sub>	Buffer Amplifier Output Voltage	-0.3 to V <sub>BUFF</sub> +0.3	V
P <sub>o</sub>	Power Dissipation (Standard Land Pattern)* <sup>1</sup>	1500	mW
T <sub>a</sub>	Operating Temperature Range	-40 to +85	°C
T <sub>stg</sub>	Storage Temperature Range	-55 to +125	°C
T <sub>j</sub>	Junction Temperature	-40 to +125	°C

\*<sup>1</sup> For more information about the Power Dissipation, please refer to PACKAGE INFORMATION.

#### ABSOLUTE MAXIMUM RATINGS

Electronic and mechanical stress momentarily exceeded absolute maximum ratings may cause the permanent damages and may degrade the life time and safety for both device and system using the device in the field. The functional operation at or over these absolute maximum ratings is not assured.

#### RECOMMENDED OPERATING CONDITIONS (ELECTRICAL CHARACTERISTICS)

All of electronic equipment should be designed that the mounted semiconductor devices operate within the recommended operating conditions. The semiconductor devices cannot operate normally over the recommended operating conditions, even if when they are used over such conditions by momentary electronic noise or surge. And the semiconductor devices may receive serious damage when they continue to operate over the recommended operating conditions.

## ELECTRICAL CHARACTERISTICS

$V_{IN\_DC} = 3.6\text{ V}$ ,  $T_a = 25^\circ\text{C}$  unless otherwise noted.

### R1293K Electrical Characteristics

Symbol	Item	Conditions	Min.	Typ.	Max.	Unit
$V_{IN}$	$V_{IN}$ Input Voltage	$V_{IN} = V_{IN\_DC} = V_{IN\_LDO}$	2.2		5.5	V
$I_{IN}$	$V_{IN}$ Supply Current	$V_{IN\_DC}=5.5\text{V}$ , $V_{FB}=1.1\text{V}$		300	550	$\mu\text{A}$
$I_{STB}$	Standby $V_{IN}$ Current	$V_{IN\_DC}=5.5\text{V}$		60	90	$\mu\text{A}$
$V_{UVLO1}$	UVLO Detector Threshold	$V_{IN\_DC}=2.2\text{V}\rightarrow 1.7\text{V}$	1.8	1.9	2.0	V
$V_{UVLO2}$	UVLO Release Voltage	$V_{IN\_DC}=1.7\text{V}\rightarrow 2.2\text{V}$		2.05	2.15	V

### DC/DC CONVERTER

$V_{FB}$	$V_{FB}$ Voltage		0.985	1.000	1.015	V
$A_v$	Opened-loop Voltage Gain			90		dB
$f_t$	Single Gain-bandwidth Range	$A_v=0\text{dB}$		1.8		MHz
$I_{AMPH}$	AMP "H" Output Current	$V_{AMP}=1\text{V}$ , $V_{FB}=0.9\text{V}$	0.3	1.4	3.5	mA
$I_{AMPL}$	AMP "L" Output Current	$V_{AMP}=1\text{V}$ , $V_{FB}=1.1\text{V}$	50	90	150	$\mu\text{A}$
$f_{OSC}$	Oscillator Frequency	$V_{DELAY}=V_{FB}=0\text{V}$ , $R_6=24\text{k}\Omega$	630	700	770	kHz
DTC_duty	DTC Maximum Duty Cycle	$R_6=24\text{k}\Omega$ , $R_5=100\text{k}\Omega$	62	72	82	%
Maxduty	Oscillator Maximum Duty Cycle	$V_{FB}=0\text{V}$	85	90	95	%
$t_{SS}$	Soft-start Time		3.5	10	16	ms
$I_{DLY}$	DELAY Pin Charge Current	$V_{DELAY}=0.8\text{V}$ , $V_{FB}=0\text{V}$	2	4	6	$\mu\text{A}$
$V_{DLY}$	DELAY Pin Detector Threshold Voltage	$V_{FB}=0\text{V}$	0.95	1.0	1.05	V
$R_{ON}$	$L_x$ ON Resistance			0.2		$\Omega$
$I_{LXLIM}$	$L_x$ Limit Current		2.0	3.0	3.7	A
$V_{OVP1}$	OVP Detector Threshold Voltage	$V_{OUT}$ rising		21	23	V
$V_{OVP2}$	OVP Release Voltage	$V_{OUT}$ falling	18	$V_{OVP1}-1$		V
$V_{SELL}$	SEL "L" Input Voltage	$V_{IN\_DC}=2.2\text{V}$			0.4	V
$V_{SELH}$	SEL "H" Input Voltage	$V_{IN\_DC}=5.5\text{V}$	1.5			V

### LDO

$V_{O\_LDO}$	LDO Output Voltage	$V_{IN\_DC} = V_{O\_LDO} + 1.0\text{V}$ , $I_{O\_LDO}=1\text{mA}$	x 0.99		x 1.01	V	
$V_{DIF}$	Dropout Voltage	$I_{O\_LDO}=250\text{mA}$	$V_{SET} < 2.4\text{V}$		600	700	mV
			$V_{SET} \geq 2.4\text{V}$		400	500	mV
$\frac{\Delta V_{O\_LDO}}{\Delta V_{IN}}$	Line Regulation	$I_{O\_LDO}=30\text{mA}$ , $V_{O\_LDO}+0.5\text{V} \leq V_{IN\_LDO} \leq 5.5\text{V}$			0.2	%/V	
$\frac{\Delta V_{O\_LDO}}{\Delta I_{OUT}}$	Load Regulation	$V_{IN\_DC} = V_{O\_LDO} + 1.0\text{V}$ , $1\text{mA} \leq I_{O\_LDO} \leq 250\text{mA}$			0.4	mV/mA	
RR	Ripple Rejection	$f=1\text{kHz}$ , Ripple Rejection $0.2\text{ V}_{p-p}$ , $I_{O\_LDO}=30\text{mA}$		65		dB	
$I_{LIM\_LDO}$	LDO Output Current Limit	$V_{IN\_DC} = V_{O\_LDO} + 1.0\text{V}$	350			mA	
$I_{SC\_LDO}$	LDO Short Current	$V_{IN\_DC} = V_{O\_LDO} + 1.0\text{V}$		70		mA	

## R1293K

NO.EA-301-160107

V<sub>IN\_DC</sub>=3.6V, Ta = 25°C unless otherwise noted.

### R1293K Electrical Characteristics

Symbol	Item	Conditions	Min.	Typ.	Max.	Unit
<b>BUFFER AMP</b>						
V <sub>BUFF</sub>	Amplifier Power Source Voltage		5		16	V
I <sub>DD_BUFF</sub>	Amplifier Supply Current	V <sub>BUFF</sub> =16V, V <sub>i</sub> =8V, VCOM 1ch + GAMMA 1 to 6ch		0.6		mA
V <sub>OS</sub>	Offset Voltage	V <sub>i</sub> =V <sub>BUFF</sub> / 2		1		mV
V <sub>CM_COM</sub>	VCOM Common-mode Input Voltage Range	VCOM ch	1.5		V <sub>BUFF</sub> -1.5	V
V <sub>CM_GM</sub>	GAMMA Common-mode Input Voltage Range	GAMMA ch	0		V <sub>BUFF</sub>	V
I <sub>O_COM</sub>	VCOM Output Current	V <sub>BUFF</sub> =10V, V <sub>i</sub> =5V	-100		100	mA
I <sub>O_GM</sub>	GAMMA Output Current	V <sub>BUFF</sub> =10V, V <sub>i</sub> =5V	-10		10	mA
$\frac{\Delta V_{O\_COM}}{\Delta I_{OUT}}$	VCOM Load Regulation	V <sub>BUFF</sub> =10V, V <sub>i</sub> =5V, -50mA ≤ I <sub>OUT</sub> ≤ +50mA		0.5	1	mV /mA
$\frac{\Delta V_{O\_GM}}{\Delta I_{OUT}}$	GAMMA Load Regulation	V <sub>BUFF</sub> =10V, V <sub>i</sub> =5V, -10mA ≤ I <sub>OUT</sub> ≤ +10mA		0.5	1	mV /mA
CMRR	Input Voltage Ripple Rejection	f=0.1kHz, V <sub>BUFF</sub> =10V, V <sub>i</sub> =5V, Ripple Rejection 50mVp-p		75		dB
PSRR	Power Source Ripple Rejection	f=0.1kHz, V <sub>BUFF</sub> =10V, V <sub>i</sub> =5V, Ripple Rejection 0.2Vp-p		70		dB
V <sub>OL_COM</sub>	VCOM "L" Output Voltage	V <sub>BUFF</sub> =10V, V <sub>i</sub> =1.5V, I <sub>o</sub> =+50mA		1.5	1.55	V
V <sub>OL_GM</sub>	GAMMA "L" Output Voltage	V <sub>BUFF</sub> =10V, V <sub>i</sub> =0V, I <sub>o</sub> =+5mA		0.1	0.2	V
		V <sub>BUFF</sub> =10V, V <sub>i</sub> =0.2V, I <sub>o</sub> =+10mA		0.2	0.25	V
		V <sub>BUFF</sub> =10V, V <sub>i</sub> =1.5V, I <sub>o</sub> =+10mA		1.5	1.55	V
V <sub>OH_COM</sub>	VCOM "H" Output Voltage	V <sub>BUFF</sub> =10V, V <sub>i</sub> =8.5V, I <sub>o</sub> =-50mA	8.45	8.5		V
V <sub>OH_GM</sub>	GAMMA "H" Output Voltage	V <sub>BUFF</sub> =10V, V <sub>i</sub> =10V, I <sub>o</sub> =-5mA	9.8	9.9		V
		V <sub>BUFF</sub> =10V, V <sub>i</sub> =9.8V, I <sub>o</sub> =-10mA	9.75	9.8		V
		V <sub>BUFF</sub> =10V, V <sub>i</sub> =8.5V, I <sub>o</sub> =-10mA	8.45	8.5		V
<b>CONTROL</b>						
V <sub>ENBL</sub>	ENB "L" Input Voltage	V <sub>IN_DC</sub> =2.2V			0.4	V
V <sub>ENBH</sub>	ENB "H" Input Voltage	V <sub>IN_DC</sub> =5.5V	1.5			V
T <sub>TSD</sub>	Thermal Shutdown Temperature	Junction Temperature		150		°C
T <sub>TSR</sub>	Thermal Shutdown Released Temperature	Junction Temperature		100		°C

All test items listed under *Electrical Characteristics* are done under the pulse load condition (T<sub>j</sub>≈T<sub>a</sub>=25°C) except Opened-loop Voltage Gain (DC/ DC), Single Gain-bandwidth Range (DC/ DC), Ripple Rejection (LDO), Input Voltage Ripple Rejection (Buffer AMP) and Power Source Ripple Rejection (Buffer AMP).

\*1 V<sub>SET</sub>=Set Output Voltage



### TYPICAL APPLICATION

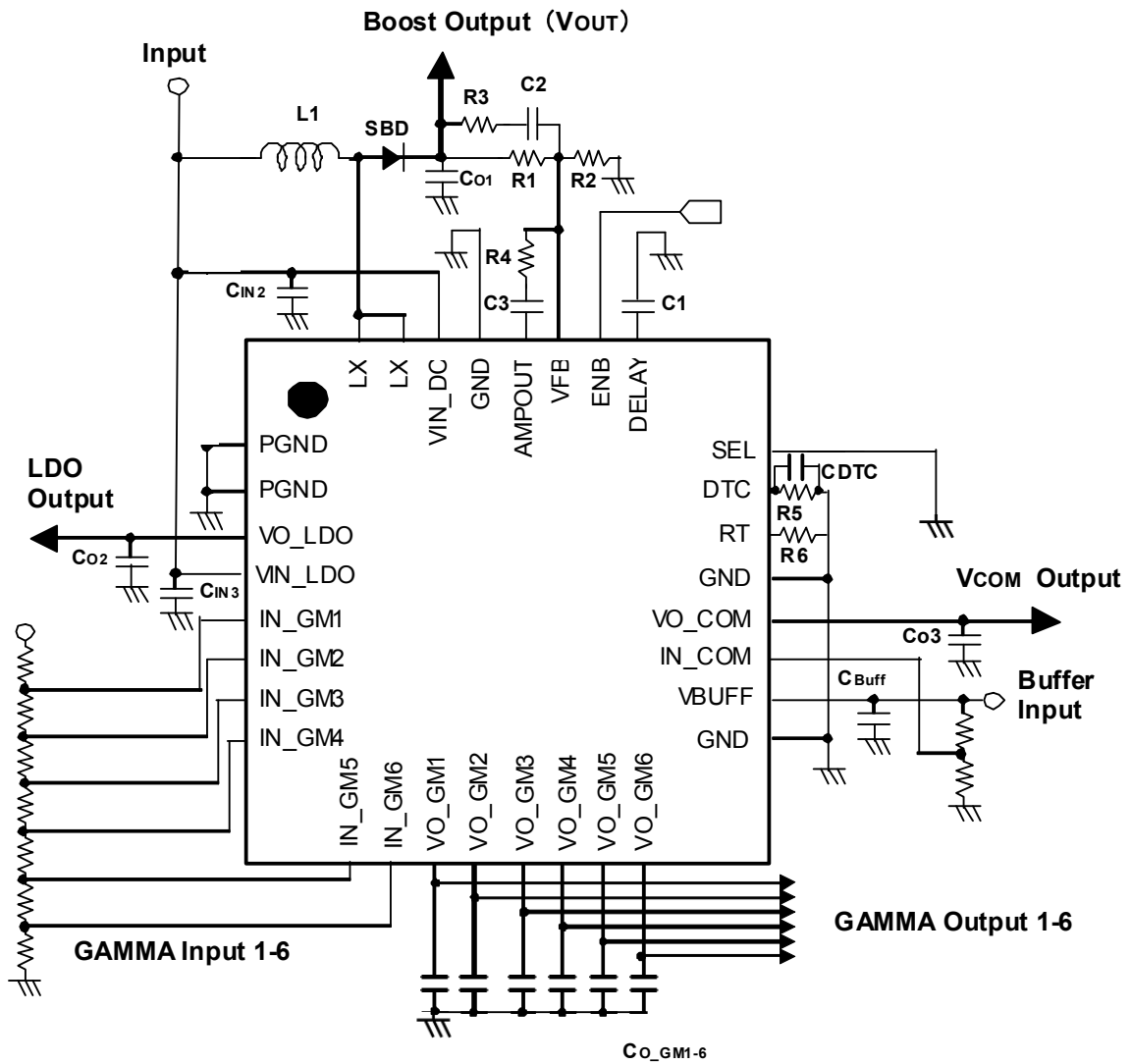

R1293K Typical Application

---

**R1293K**

---

NO.EA-301-160107

## External Parts Example

Vout [V]	Frequency [kHz]	L1	CIN2	CO1	VO_GM [pF]
8~10	300	VLF5014S-4R7M1R7	C1608JB0J106M	GRM21BB31E475KA75B	1000
10~12	300	VLF5014S-4R7M1R7	C1608JB0J106M	GRM21BB31E475KA75B * 2	1000
12~16	300	NR6020T4R7N	C1608JB0J106M	GRM21BB31E475KA75B * 2	1000
8~10	700	NR4018T4R7M	GRM21BB31E475KA75B	GRM21BB31E475KA75B	1000
10~12	700	NR4018T4R7M	GRM21BB31E475KA75B	GRM21BB31E475KA75B * 2	1000
12~16	700	VLF5014S-4R7M1R7	GRM21BB31E475KA75B	GRM21BB31E475KA75B * 2	1000
8~10	1000	NR4018T4R7M	GRM21BB31E475KA75B	GRM21BB31E475KA75B	1000
10~12	1000	NR4018T4R7M	GRM21BB31E475KA75B	GRM21BB31E475KA75B * 2	1000
12~16	1000	VLF5014S-4R7M1R7	GRM21BB31E475KA75B	GRM21BB31E475KA75B * 2	1000

Vout [V]	Frequency [kHz]	CO3	CIN3	CO2
8~10	300	TMK316BJ106MD-TD	CM105B105K10AT	CM105B105K10AT
10~12	300	TMK316BJ106MD-TD	CM105B105K10AT	CM105B105K10AT
12~16	300	TMK316BJ106MD-TD	CM105B105K10AT	CM105B105K10AT
8~10	700	TMK316BJ106MD-TD	CM105B105K10AT	CM105B105K10AT
10~12	700	TMK316BJ106MD-TD	CM105B105K10AT	CM105B105K10AT
12~16	700	TMK316BJ106MD-TD	CM105B105K10AT	CM105B105K10AT
8~10	1000	TMK316BJ106MD-TD	CM105B105K10AT	CM105B105K10AT
10~12	1000	TMK316BJ106MD-TD	CM105B105K10AT	CM105B105K10AT
12~16	1000	TMK316BJ106MD-TD	CM105B105K10AT	CM105B105K10AT

Vout [V]	Frequency [kHz]	R4 [kΩ]	C3 [pF]	R3 [kΩ]	C2 [pF]	R1 [kΩ]	R2 [kΩ]	R6 [kΩ]	R5 [kΩ]	CDTC [uF]	C1 [uF]
8~10	300	3.3	1000	8.2	120	(VOUT-1) * R2	33	62	330	-	0.22
10~12	300	3.3	1000	8.2	120	(VOUT-1) * R2	33	62	330	-	0.22
12~16	300	4.7	1500	10	47	(VOUT-1) * R2	22	62	330	-	0.22
8~10	700	3.3	1000	8.2	120	(VOUT-1) * R2	33	24	130	-	0.22
10~12	700	3.3	1000	8.2	120	(VOUT-1) * R2	33	24	130	-	0.22
12~16	700	4.7	1500	10	47	(VOUT-1) * R2	22	24	130	-	0.22
8~10	1000	3.3	1000	8.2	120	(VOUT-1) * R2	33	16	91	-	0.22
10~12	1000	3.3	1000	8.2	120	(VOUT-1) * R2	33	16	91	-	0.22
12~16	1000	4.7	1500	10	47	(VOUT-1) * R2	22	16	91	-	0.22

## TECHNICAL NOTES

### Output Voltage Setting (DC/ DC)

$V_{OUT}$  controls the  $V_{FB}$  pin voltage to maintain  $V_{FB}=1.0V$ .  $V_{OUT}$  can be set using R1 and R2 in the following equation.  $V_{OUT}$  voltage should be set between 5V to 16V. Also, the sum of R1 and R2 should be equal or less than 500k $\Omega$ .

$$V_{OUT} = V_{FB} \times (R1 + R2) / R2$$

### Phase Compensation Setting (DC/ DC)

A 180 degree phase shift may be caused by the inductor (L1) and the capacitor ( $C_{01}$ ). The phase shift reduces phase margin and stability of the system. Thus, it is necessary to keep a leading phase margin. In the following equation, the pole is made by L1 and  $C_{01}$ .

$$F_{pole} \sim 1 / \{2 \times \pi \times \sqrt{L1 \times C_{01}}\}$$

The phase compensation and the system gain can be set by using R4, C3 and C2. Please refer to *Typical Application* (P.10,11) for positioning and setting value examples. In the following equation, the zero is made by R4 and C3.

$$F_{zero} \sim 1 / (2 \times \pi \times R4 \times C3)$$

When selecting the values for R4 and C3, please consider that the cutoff frequency of zero should be approximately equal to the cutoff frequency of pole.

For example, if  $L1=10\mu H$  and  $C_{01}=10\mu F$ , the cutoff frequency of pole is approximately 16kHz.

The gain can be set by the resistance ratio of R4 and  $R_T$  which is the combined resistance of R1 and R2 ( $R_T=R1 \times R2 / (R1+R2)$ ). If R4 is larger than  $R_T$ , the gain becomes high. The high gain improves the response characteristic; however, the extremely high gain decreases stability of the operation. It is important to select an appropriate value for R4. In the following equation, zero is made by R1 and C2.

$$F_{zero} \sim 1 / (2 \times \pi \times R1 \times C2)$$

Set the cutoff frequency of zero lower than the cutoff frequency of pole.

### Reduction of Feedback Voltage Noise (DC/ DC)

If the system noise is large, it may wrap around the  $V_{FB}$  pin and causes unstable operation. In this case, set R1 and R2 resistance values lower to reduce the noise entering the  $V_{FB}$  pin. Or, place R3 with 1k $\Omega$  to 5k $\Omega$  to reduce the noise entering the  $V_{FB}$  pin as shown in *Typical Application* (P.10,11).

### Input Voltage Setting (DC/ DC and LDO)

The input voltage ranges of the  $V_{IN\_DC}$  and  $V_{IN\_LDO}$  pins are from 2.2V to 5.5V. Place a bypass capacitor between  $V_{IN}$  and GND. Use Boost Output as the input voltage for the  $V_{BUFF}$  pin.

---

## R1293K

---

NO.EA-301-160107

### Oscillator Frequency Setting (DC/ DC)

By connecting R6 to the the RT pin,  $f_{osc}$  can be set in the range of 300kHz to 1MHz. R6 can be calculated by inserting a desired oscillator frequency value into  $f_{osc}$  in the following equation.

$$R6 = 19.128 \times 10^9 / F_{osc} - 3443$$

Example: Oscillator Frequency 700kHz

$$R6 = 19.128 \times 10^9 / (700 \times 10^3) - 3443 = 23883 \approx 24k\Omega$$

### Maxduty and Maxduty Soft-start Adjustment (DC/ DC)

Maxduty is preset to 90% (Typ.); however, it can be set lower by adding R5 to the DTC pin. Maxduty is determined by R6 and R5 as shown in the equation below. The preset Maxduty is compared with the Maxduty set by the DTC pin, and the lower Maxduty will be selected.

$$\text{Maxduty (DC)} = \frac{0.3267 \times R5 - 0.6285 \times R6 + 2367}{R6 + 3550}$$

Example: R6=24k $\Omega$ , R5=110k $\Omega$

$$\begin{aligned} \text{Maxduty} &= (0.3267 \times 110000 - 0.6285 \times 24000 + 2367) / (24000 + 3550) \\ &\approx 0.843 \rightarrow 84.3\% \end{aligned}$$

By adding  $C_{DTC}$  to the DTC pin, Maxduty can increase gradually and the inrush current can be controlled. (Maxduty Soft-start). After start-up, Maxduty after t-time (Maxduty (t)) can be calculated by the following equation.

$$\text{Maxduty ( t )} = \frac{0.3267 \times R5 \times [ 1 - \text{EXP}(-t / C_{DTC} \times R5 ) ] - 0.6285 \times R6 + 2367}{R6 + 3550}$$

Example: R6=24k $\Omega$ , R5=110k $\Omega$ ,  $C_{DTC}$ =0.047 $\mu$ F to 0.47 $\mu$ F

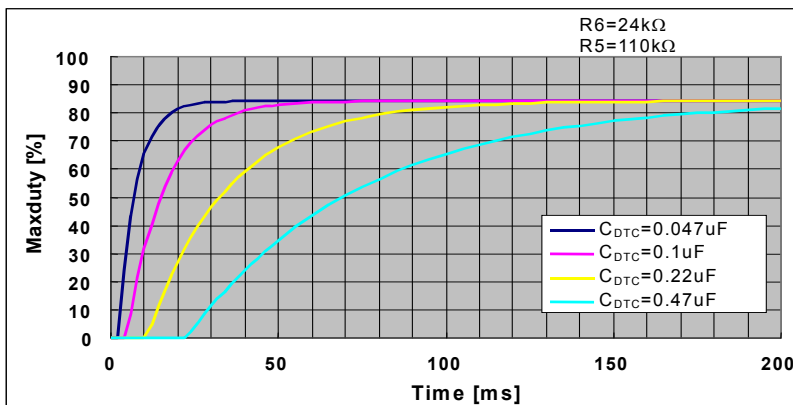

### Typical Application with RT Pin/ DTC Pin

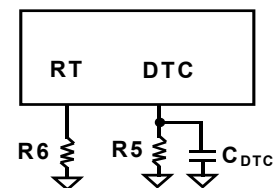

When using Maxduty soft-start, it is recommended that latch protection delay time ( $t_{DLY}$ ) be set  $t_{DLY} > 6 \times (R5 \times C_{DTC})$ .  $t_{DLY}$  should be longer than the soft-start time.

**Overcurrent Protection (DC/ DC)**

The overcurrent protection circuit monitors the Nch-switch current and immediately turns off if the Nch-switch current reaches the current limit. Nch-switch turns on every internal reference clock cycle and turns off if the Nch-switch current reaches the current limit again.

**Short Current Protection/ Protection Delay Time Setting (DC/ DC)**

If Boost Output drops and causes the VFB voltage drop to 85% of the preset value, the IC recognizes a short-circuit and starts to charge C1. If the short-circuit condition persists for a certain period of time and the DELAY pin voltage reaches  $V_{DLY}$ , the latch-type protection circuit shuts down Boost Output.  $t_{DLY}$  can be set by C1 shown in the following equations.

$$t_{DLY} = C \times V_{DLY} / I_{DLY}$$

To release latch state, make  $V_{IN,DC}$  voltage below the UVLO detector threshold and then restart, or set ENB "H" once and then set it back to "L".

**Undervoltage Lock Out (DC/ DC)**

If the  $V_{IN,DC}$  pin voltage becomes equal or lower than UVLO detector threshold, the UVLO circuit immediately disables the switching output.

**Thermal Shutdown (LDO and Buffer AMP)**

Thermal shutdown circuit detects overheating of the IC and turns off VCOM Output, GAMMA Output, and LDO Outputs to reset the IC if the junction temperature becomes more than the detector threshold. If the causes of overheating are removed and the junction temperature decreases to the release temperature, the IC restarts.

**Standby Mode (DC/ DC and Buffer AMP)**

By setting the ENB pin "H", DC/ DC and Buffer AMP go into Standby mode and the output shuts down. LDO is always-on and outputs voltage.

**SEL Pin Mode Switching (DC/ DC)**

By setting the SEL pin voltage "L", the switching speed of a built-in MOSFET shifts to moderate mode to reduce the influences of noise to external parts. The SEL pin voltage operates in normal mode when "H".

**Diode, Inductor and Capacitor Selections (DC/ DC, LDO and Buffer AMP)**

Efficiency and stability of system can be affected by the following conditions. Spike voltage may be generated by the influence of an inductor when Nch MOSFET turns off. Therefore, diodes, inductors and capacitors should not exceed the voltage tolerance of the capacitor connected to  $V_{OUT}$  or their respected rated values (voltage, current and power). Please refer to *Operation of DC/ DC Converter and Output Current* (P.15). Choose the diode with low forward voltage (schottky diode), small reverse current and fast switching speed.

**Operation of DC/ DC Converter and Output Current**

**Figure 1. Basic Circuit**

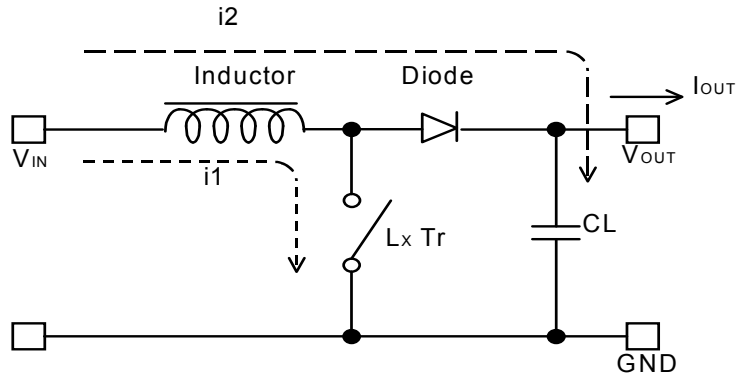

**Figure 2. The inductor current (IL) flowing through the inductor (L)**

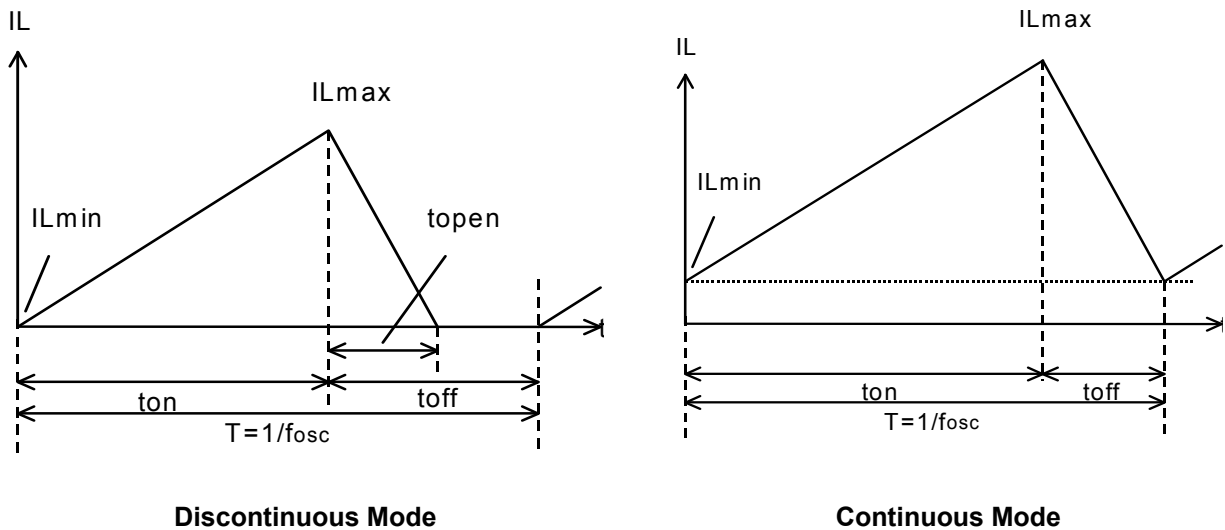

**Discontinuous Mode**

**Continuous Mode**

There are two operation modes in the PWM step-up DC/ DC converter: continuous mode and discontinuous mode. When a transistor is in the On-state, the voltage to be applied to L is described as  $V_{IN}$ . An increase in the inductor current ( $i1$ ) can be written as follows:

$$\Delta i1 = V_{IN} \times t_{on} / L \dots\dots\dots \text{Formula 1}$$

In the step-up circuit, the energy accumulated during the On-state is transferred into the capacitor even in the Off-state. A decrease in the inductor current ( $i2$ ) can be written as follows:

$$\Delta i2 = (V_{OUT} - V_{IN}) \times t_{open} / L \dots\dots\dots \text{Formula 2}$$

In the PWM switching control,  $i_1$  and  $i_2$  become continuous when  $t_{open}=t_{off}$ , which is called continuous mode.

When the IC is in the continuous mode and operates in steady-state conditions, the variations of  $i_1$  and  $i_2$  are same:

$$V_{IN} \times t_{on} / L = (V_{OUT} - V_{IN}) \times t_{off} / L \dots\dots\dots \text{Formula 3}$$

Therefore, the duty cycle in the continuous mode is:

$$\text{Duty} = t_{on} / (t_{on} + t_{off}) = (V_{OUT} - V_{IN}) / V_{OUT} \dots\dots\dots \text{Formula 4}$$

When  $t_{open}=t_{off}$ , the average of  $I_L$  is:

$$I_L (\text{Ave.}) = V_{IN} \times t_{on} / (2 \times L) \dots\dots\dots \text{Formula 5}$$

If the input voltage ( $V_{IN}$ ) is equal to  $V_{OUT}$ , the output current ( $I_{OUT}$ ) is:

$$I_{OUT} = V_{IN}^2 \times t_{on} / (2 \times L \times V_{OUT}) \dots\dots\dots \text{Formula 6}$$

If  $I_{OUT}$  is larger than Formula 6, the IC switches to the continuous mode.

$I_{Lmax}$  flowing through  $L$  is:

$$I_{Lmax} = I_{OUT} \times V_{OUT} / V_{IN} + V_{IN} \times t_{on} / (2 \times L) \dots\dots\dots \text{Formula 7}$$

$$I_{Lmax} = I_{OUT} \times V_{OUT} / V_{IN} + V_{IN} \times T \times (V_{OUT} - V_{IN}) / (2 \times L \times V_{OUT}) \dots\dots\dots \text{Formula 8}$$

As a result,  $I_{Lmax}$  becomes larger compared to  $I_{OUT}$ .

When considering the input and output conditions or selecting the external parts, please pay attention to  $I_{Lmax}$ .

The above calculations are based on the ideal operation of the ICs in the continuous mode. They do not include the losses caused by the external parts or  $L_x$  switch. The actual maximum output current will be 50% to 80% of the above calculation results. Especially, if  $I_L$  is large or  $V_{IN}$  is low, it may cause the switching losses. As for  $V_{OUT}$ , please consider  $V_F$  of the diode (approximately 0.8V).

# R1293K

NO.EA-301-160107

## TYPICAL CHARACTERISTICS

$V_{IN} = V_{IN\_DC} = V_{IN\_LDO}$ , unless otherwise noted.

### 1) Output Voltage vs. Output Current (DCDC)

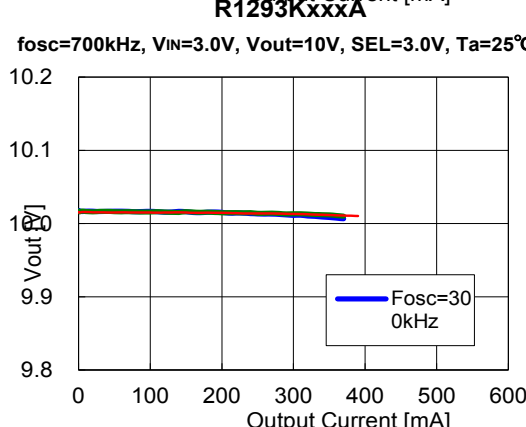
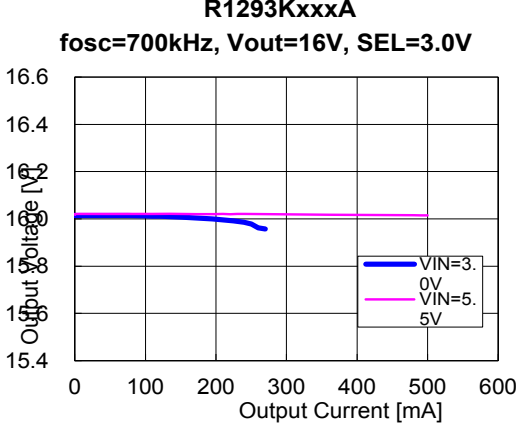
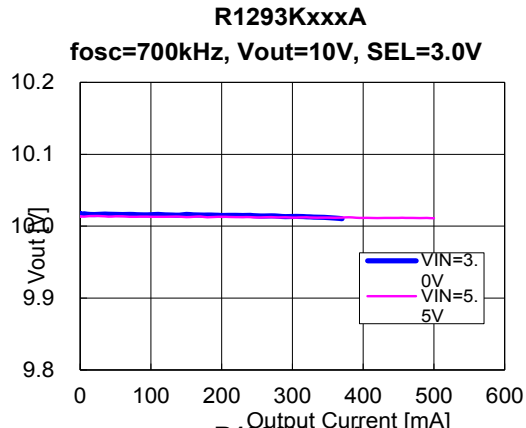
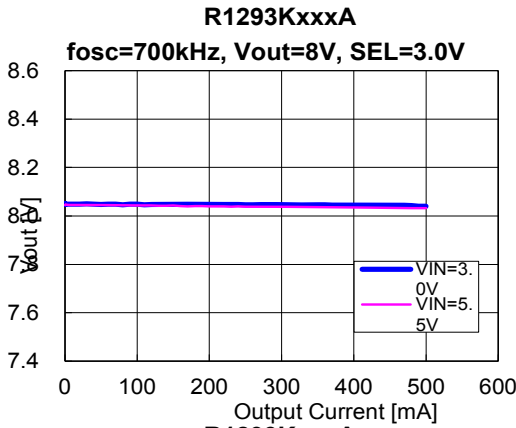

### 2) Efficiency vs. Output Current (DCDC)

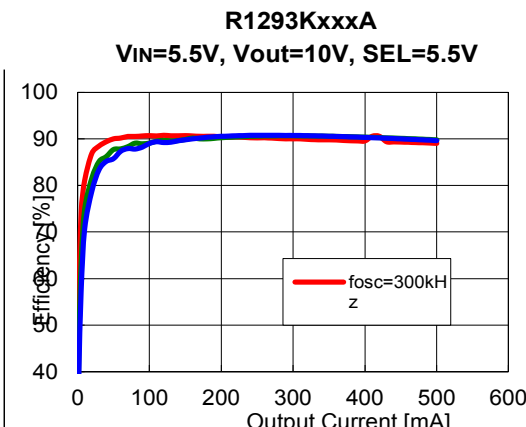
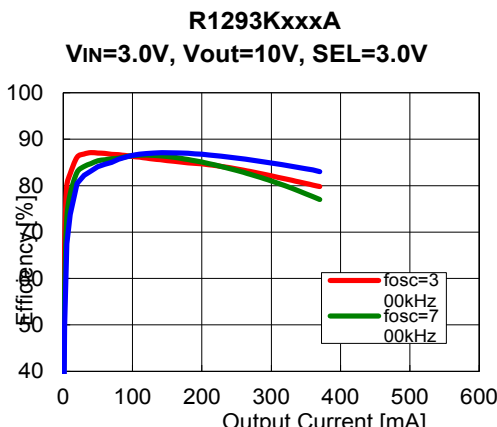



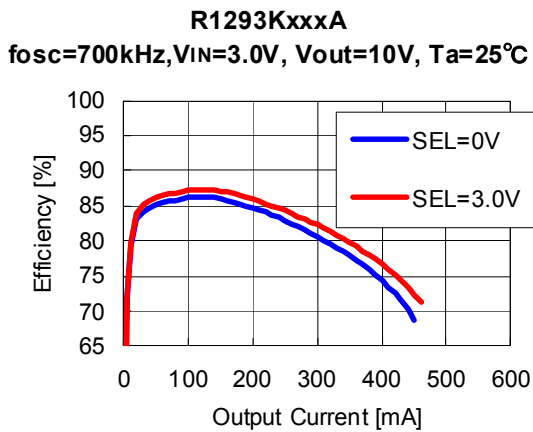
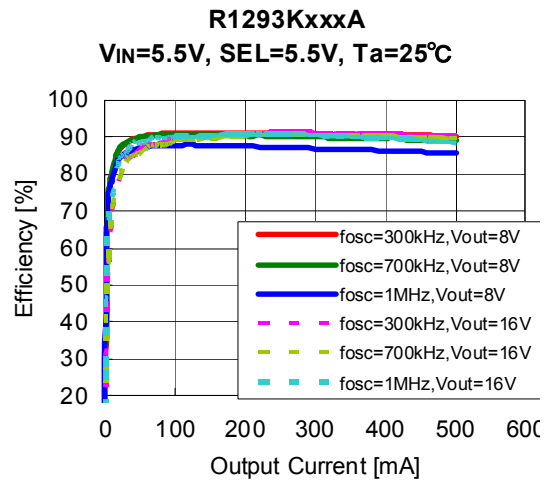
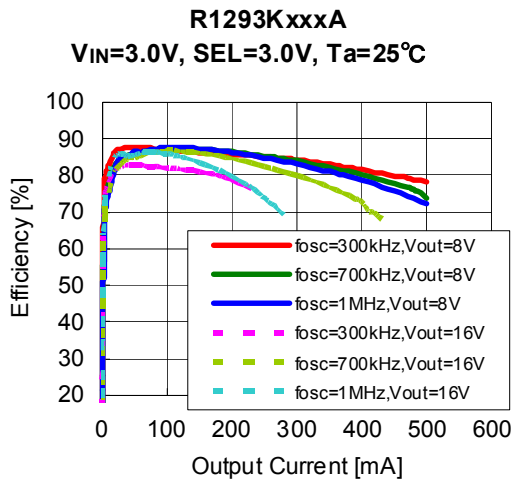

**3) Output Voltage Waveform (DCDC)**

**R1293KxxxA**  
**fosc=700kHz, V<sub>IN</sub>=3.0V, V<sub>out</sub>=10V, T<sub>a</sub>=25°C**  
**SEL=0V, I<sub>out</sub>=80mA**

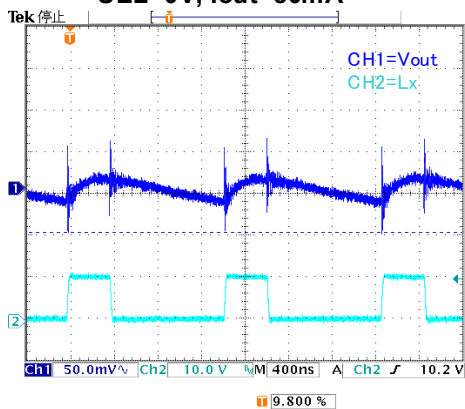

**R1293KxxxA**  
**fosc=700kHz, V<sub>IN</sub>=3.0V, V<sub>out</sub>=10V, T<sub>a</sub>=25°C**  
**SEL=3.0V, I<sub>out</sub>=80mA**

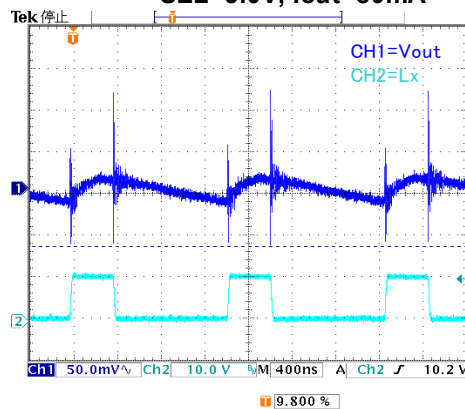

---

# R1293K

---

NO.EA-301-160107

## 4) VFB Voltage vs. Temperature

R1293KxxxA

V<sub>IN</sub>=3.6V

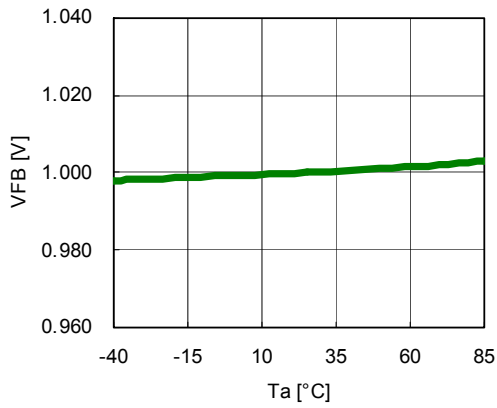

## 5) Oscillator Frequency vs. Temperature

R1293KxxxA

fosc=300kHz, V<sub>IN</sub>=3.6V, V<sub>DELAY</sub>=V<sub>F</sub>B=0V

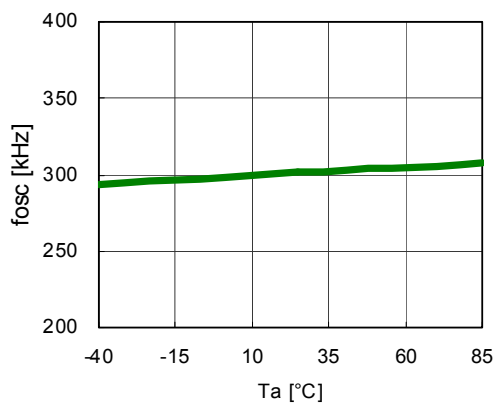

R1293KxxxA

fosc=700kHz, V<sub>IN</sub>=3.6V, V<sub>DELAY</sub>=V<sub>F</sub>B=0V

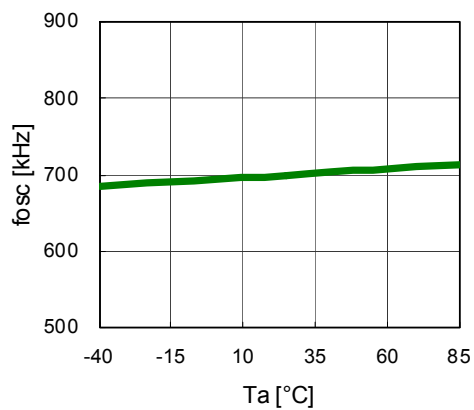

R1293KxxxA

fosc=1MHz, V<sub>IN</sub>=3.6V, V<sub>DELAY</sub>=V<sub>F</sub>B=0V

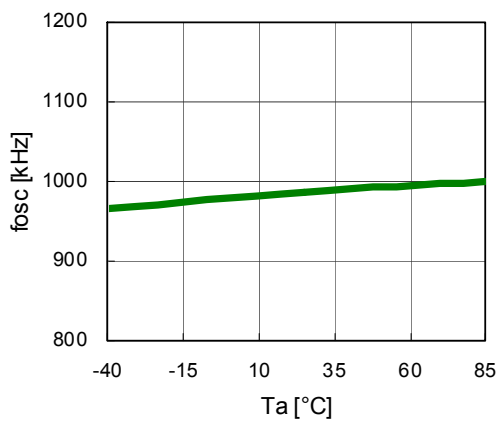

6) Oscillator Frequency vs. VIN Voltage

R1293KxxxA

fosc=300kHz, VIN=3.6V, VDELAY=VFB=0V, Ta=25°C

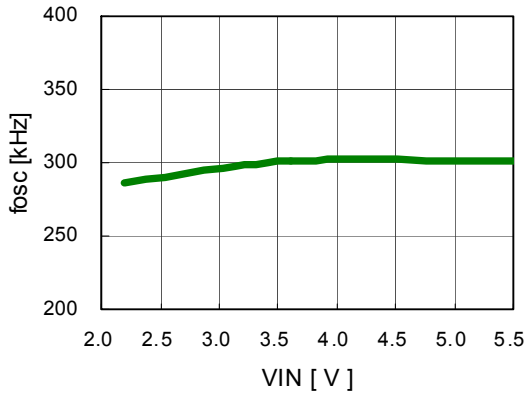

R1293KxxxA

fosc=700kHz, VIN=3.6V, VDELAY=VFB=0V, Ta=25°C

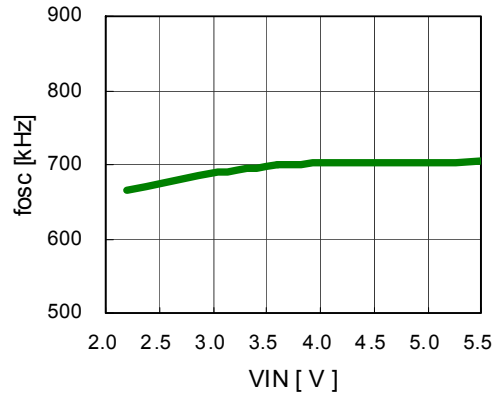

7) Oscillator Frequency vs. R6 Resistance

R1293KxxxA

fosc=1MHz, VIN=3.6V, VDELAY=VFB=0V, Ta=25°C

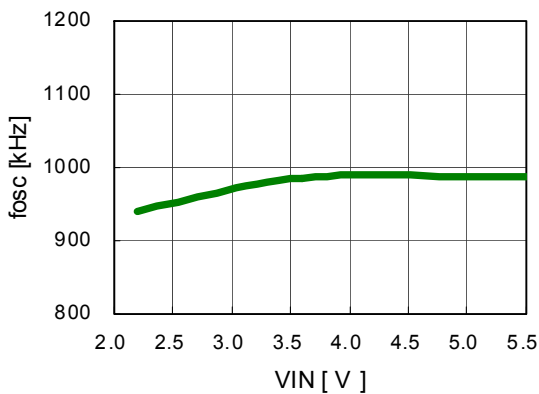

R1293KxxxA

VIN=3.6V, VDELAY=VFB=0V, Ta=25°C

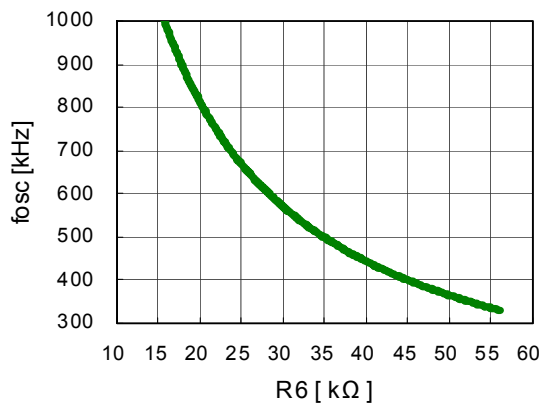

8) Standby VIN Current vs. Temperature 9) Supply VIN Current vs. Temperature

R1293KxxxA

VIN=ENB=5.5V

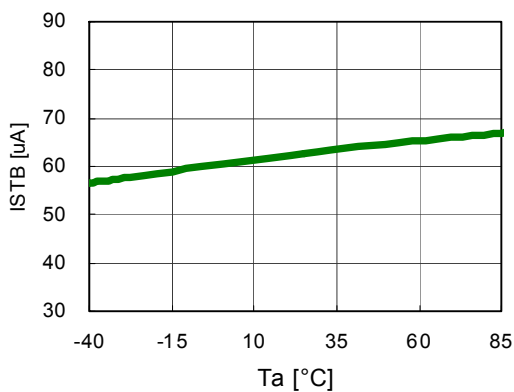

R1293KxxxA

VIN=5.5V, ENB=0V, SEL=0V, VFB=1.1V

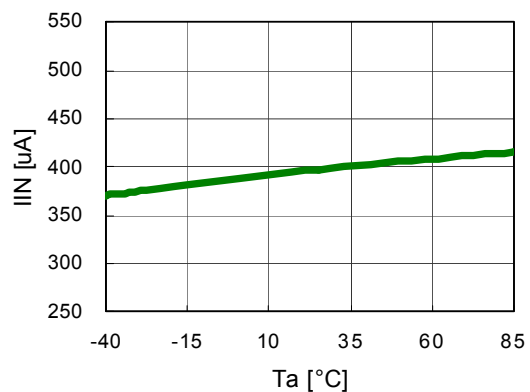

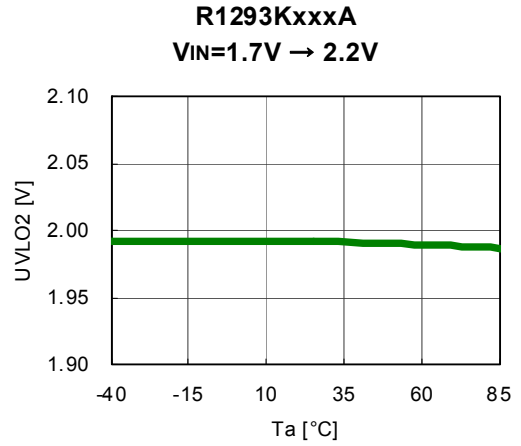
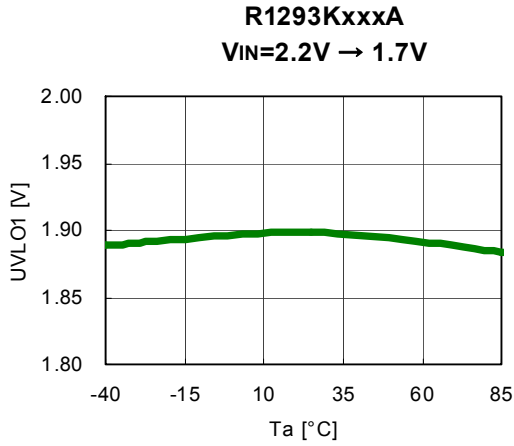
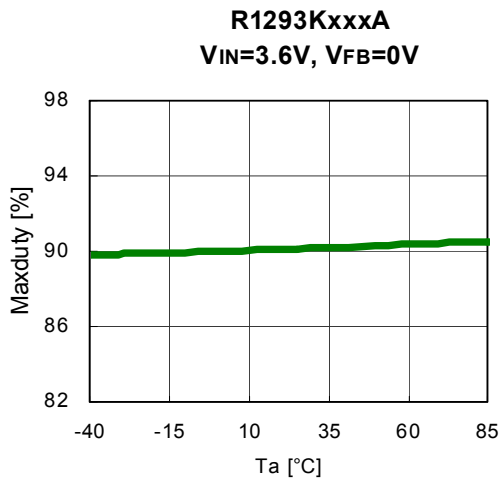
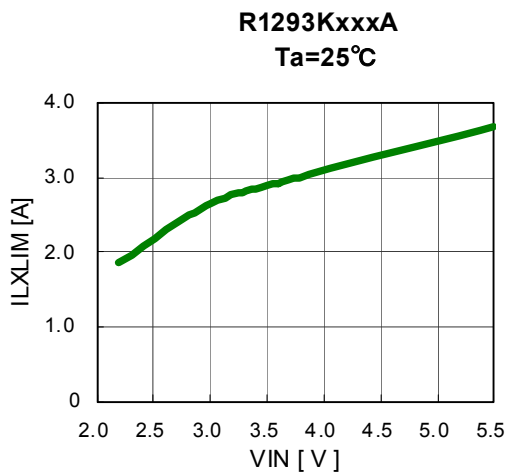
**10) UVLO Detector Threshold vs. Temperature    11) UVLO Released Voltage vs. Temperature****12) Oscillator Maximum Duty Cycle vs. Temperature****13) LX Limit Current vs. VIN Voltage**

**14) DELAY Pin Charge Current vs. Temperature**

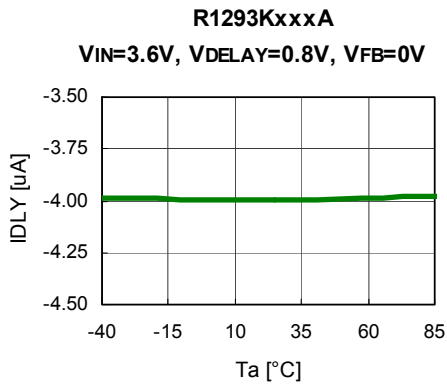

**15) DELAY Pin Discharge Current vs. Temperature**

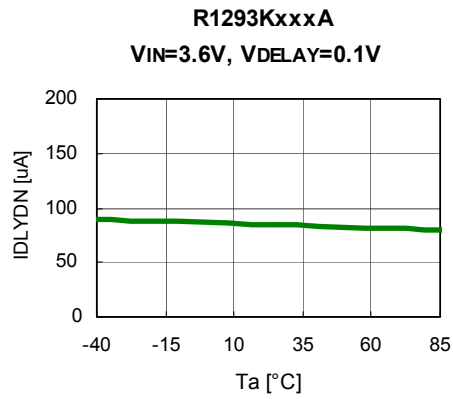

**16) DELAY Pin Detector Threshold Voltage vs. Temperature**

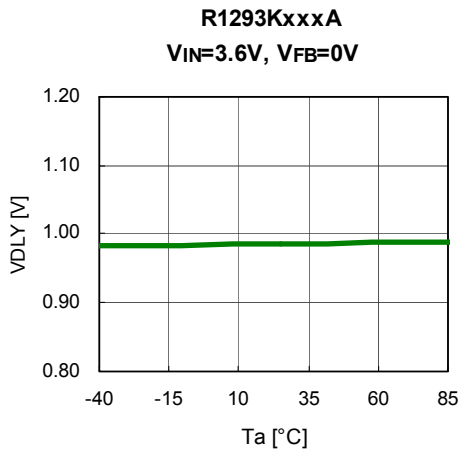

**17) ENB "L" Input Voltage vs. Temperature**

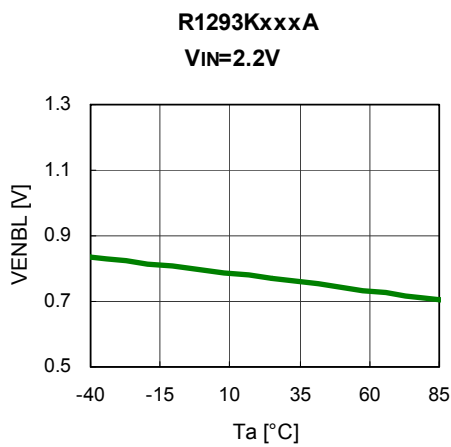

**18) ENB "H" Input Voltage vs. Temperature**

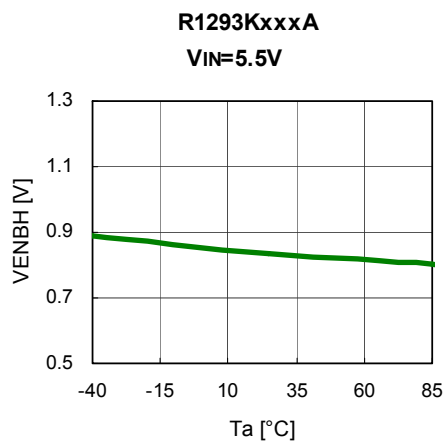

---

# R1293K

---

NO.EA-301-160107

## 19) DTC Maximum Duty Cycle vs. Temperature    20) DTC Maximum Duty Cycle vs. R5/R6

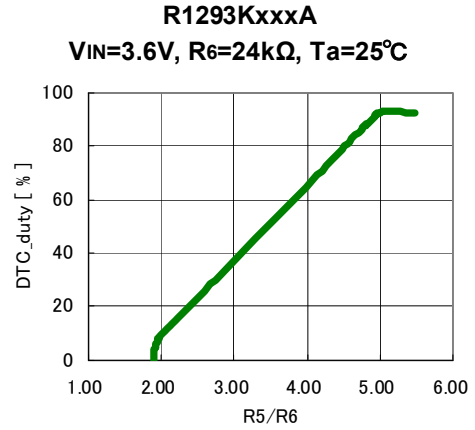
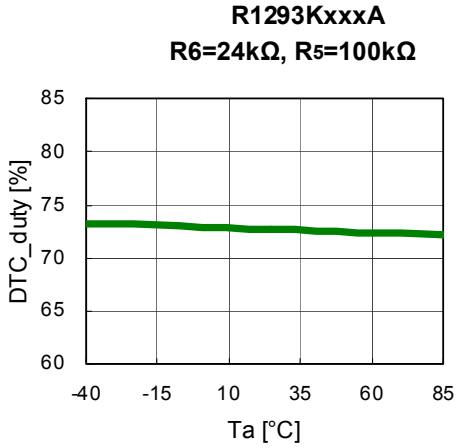

## 21) Soft Start Time vs. Temperature

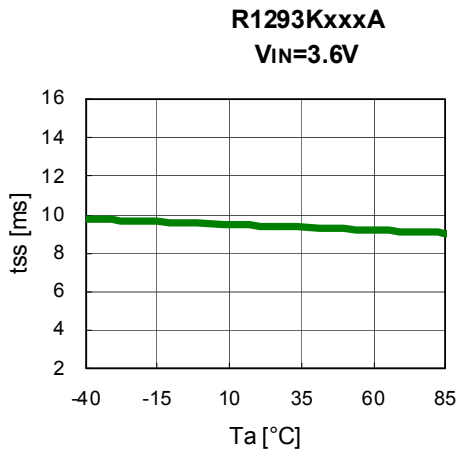

## 22) OVP Detector Threshold Voltage vs Temperature

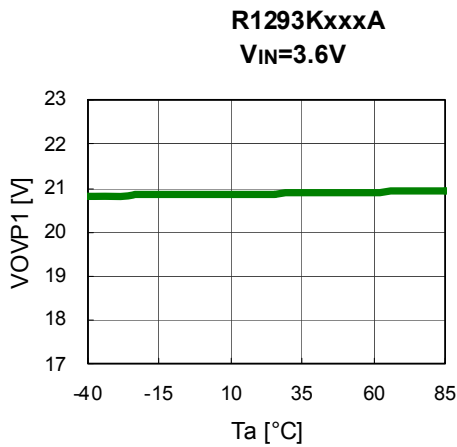

## 23) OVP Release Voltage vs Temperature

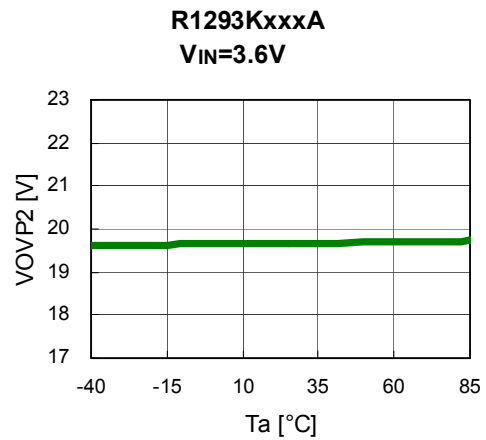

24) SEL "L" Input Voltage vs. Temperature    25) SEL "H" Input Voltage vs. Temperature

R1293K181A  
VIN=2.2V

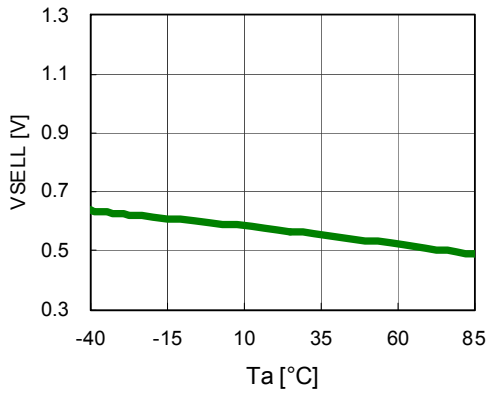

R1293K251A  
VIN=5.5V

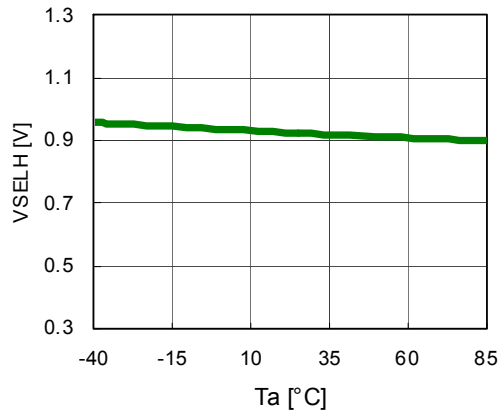

26) Output Voltage vs. Output Current (LDO)

R1293K181A  
Ta=25°C

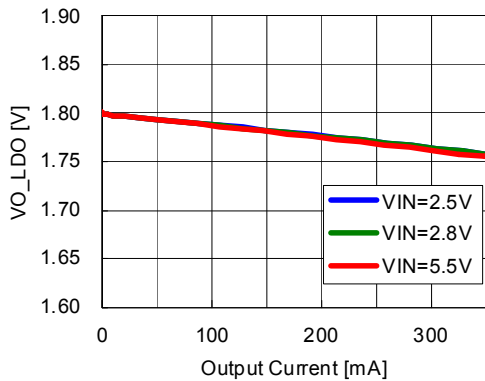

R1293K251A  
Ta=25°C

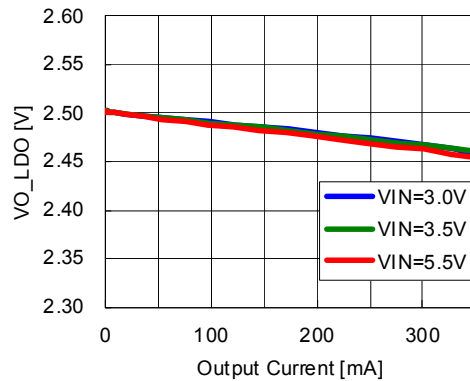

R1293K181A  
Ta=25°C

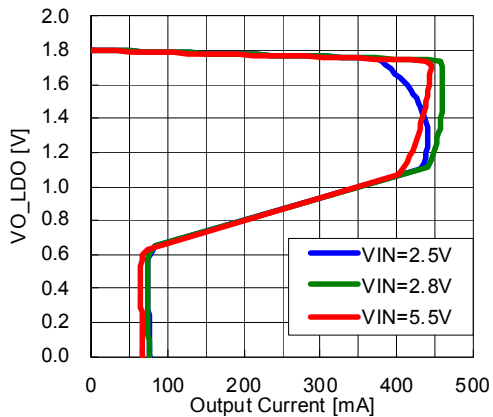

R1293K251A  
Ta=25°C

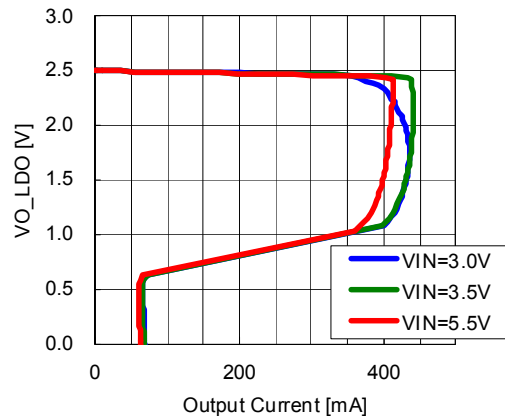

# R1293K

NO.EA-301-160107

## 27) Output Voltage vs. Temperature (LDO)

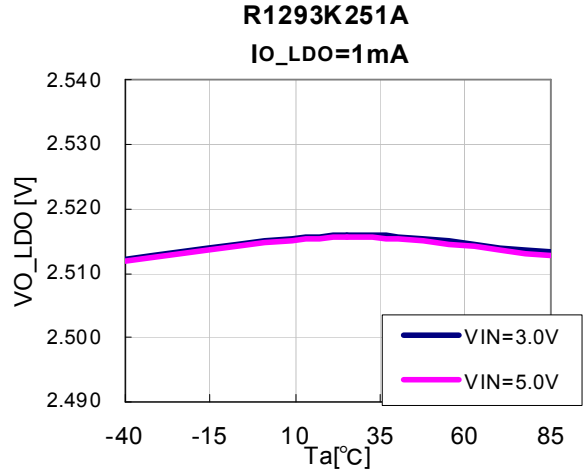
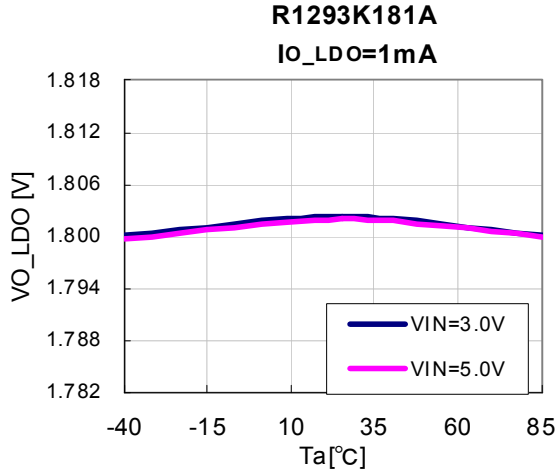

## 28) Output Voltage vs. VIN Voltage (LDO)

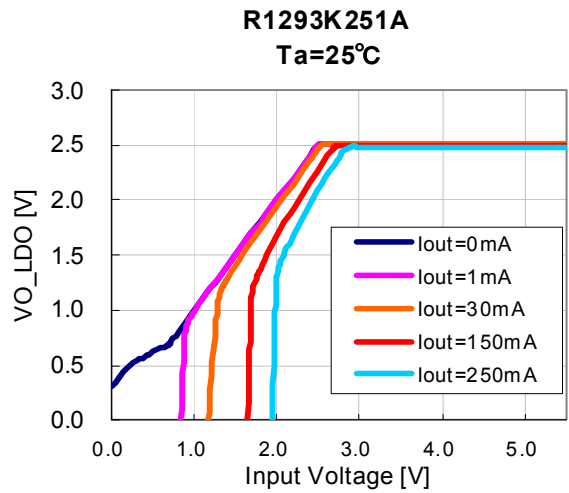
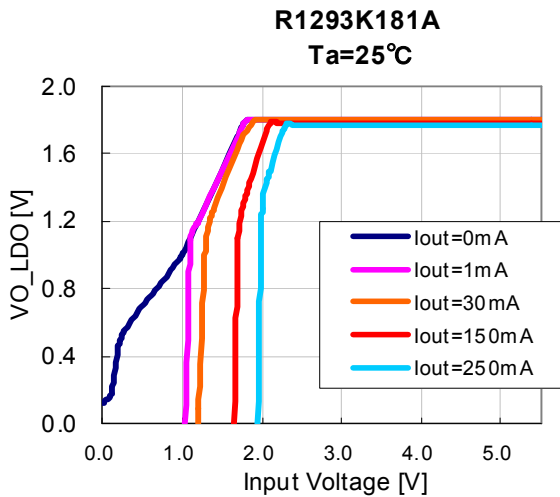

## 29) LDO Ripple Rejection vs. Frequency

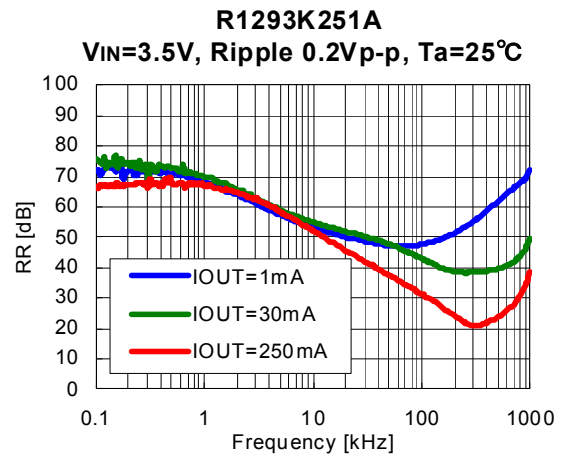
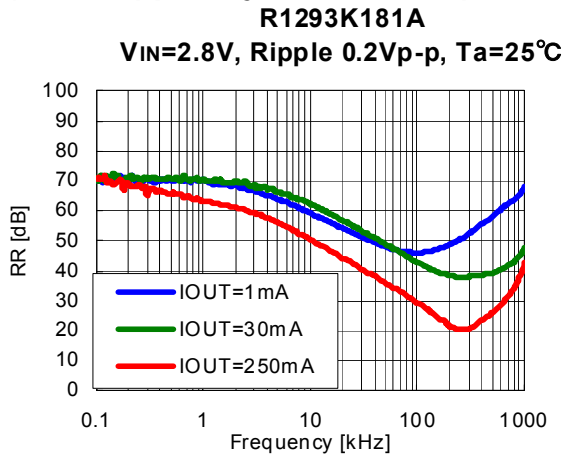



**30) Amplifier Supply Current vs. Temperature (BUFFER AMP)**

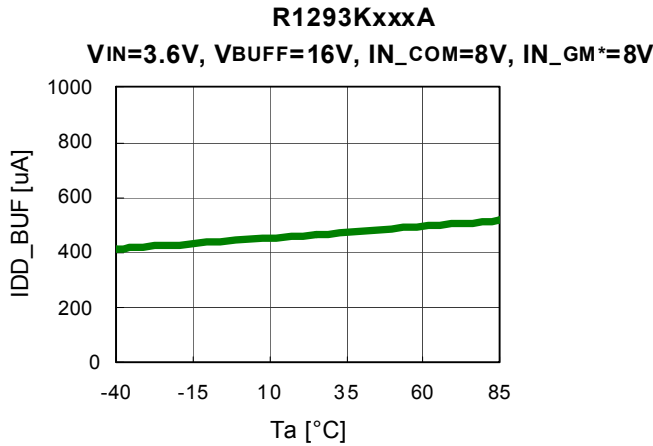

**31) VCOM Offset Voltage vs. Temperature**

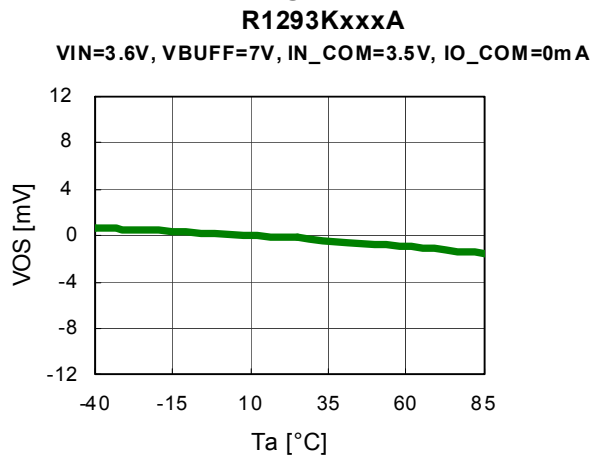

**32) GAMMA Offset Voltage vs. Temperature**

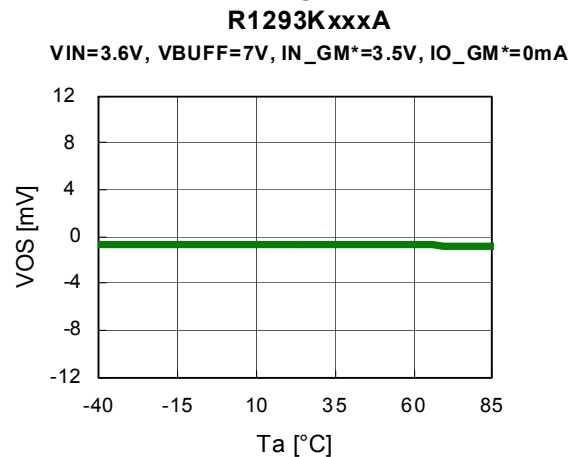

**33) VCOM Output Voltage vs. Temperature**

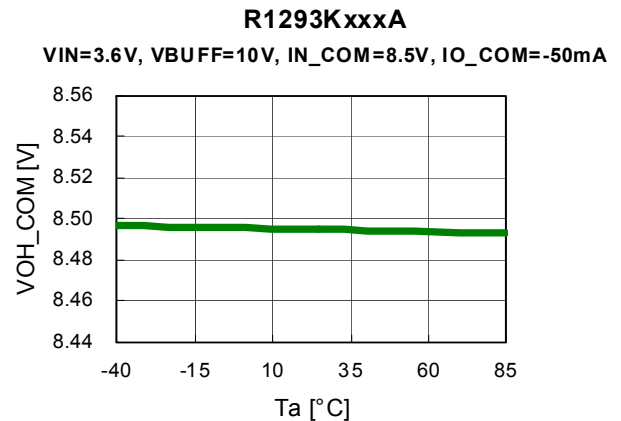
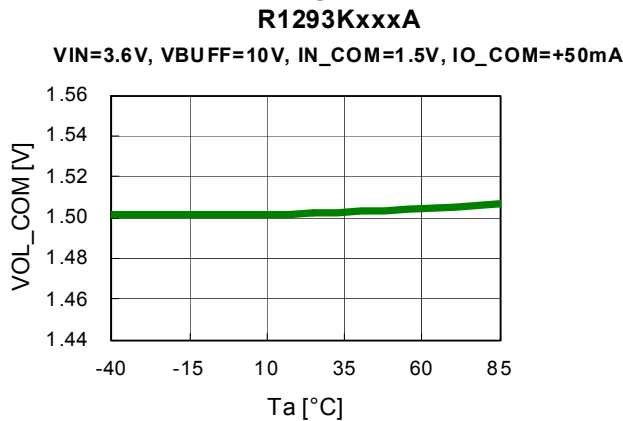

---

# R1293K

---

NO.EA-301-160107

## 34) GAMMA Output Voltage vs. Temperature

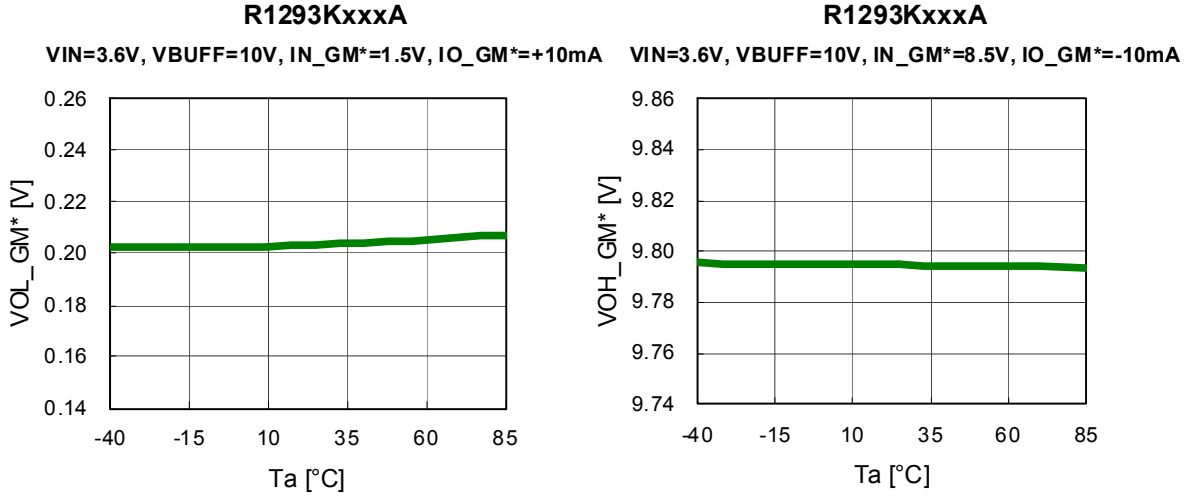

## 35) VCOM Output Voltage vs. Output Current

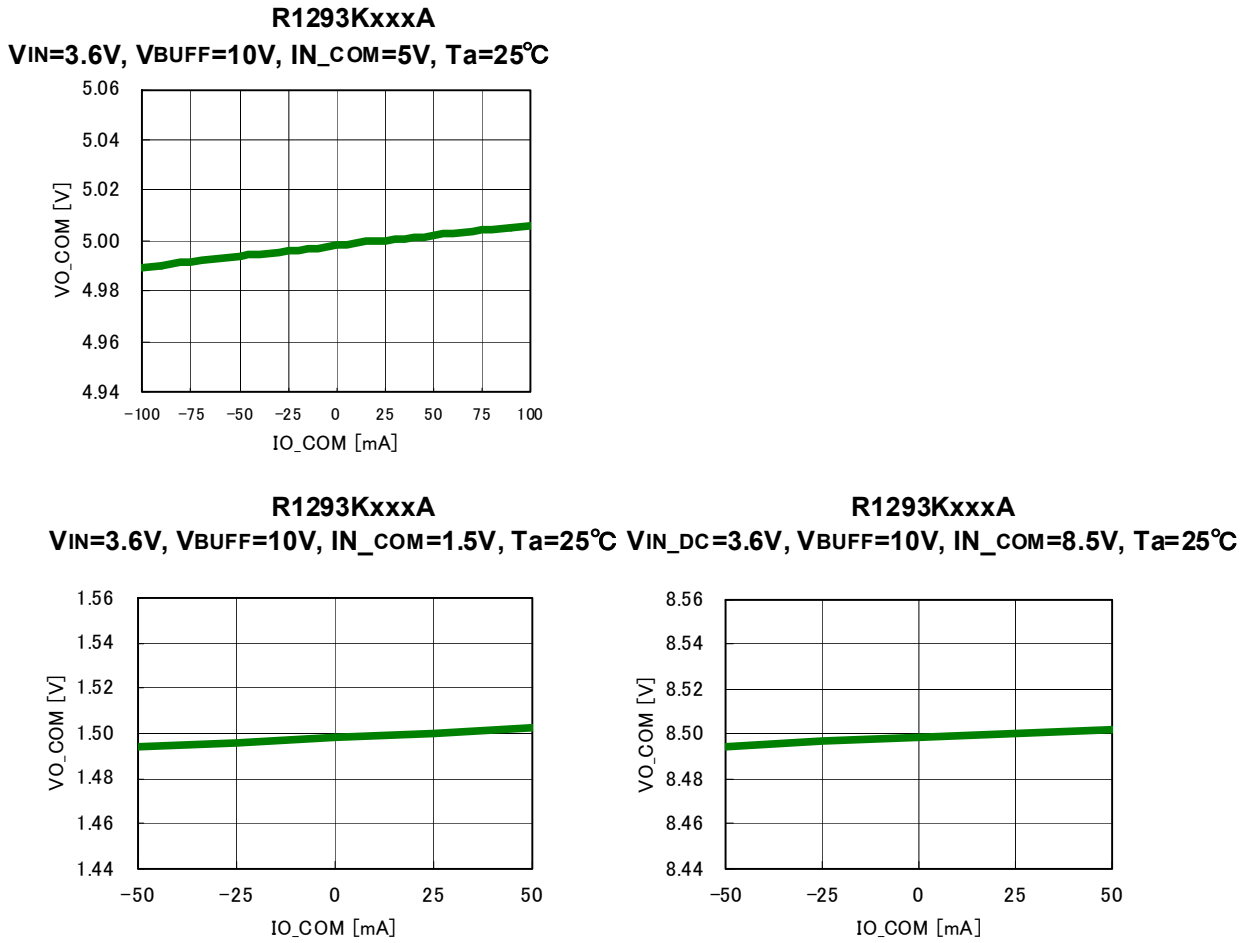

36) GAMMA Output Voltage vs. Output Current

R1293KxxxA

VIN=3.6V, VBUFF=10V, IN\_GM\*=5V, Ta=25°C

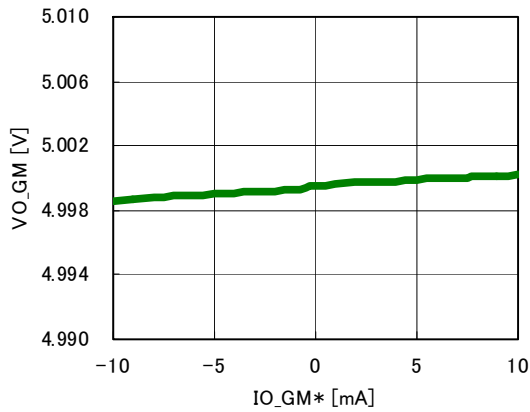

R1293KxxxA

VIN=3.6V, VBUFF=10V, IN\_GM\*=0.2V, Ta=25°C

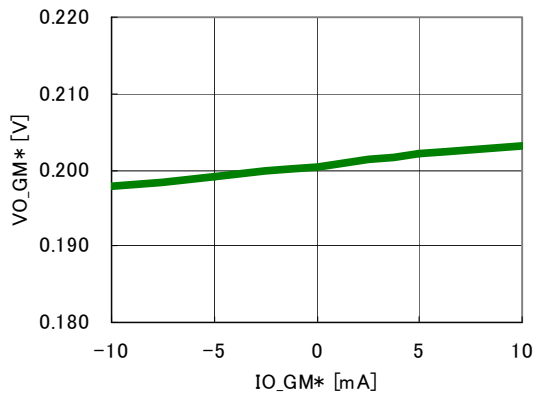

R1293KxxxA

VIN=3.6V, VBUFF=10V, IN\_GM\*=9.8V, Ta=25°C

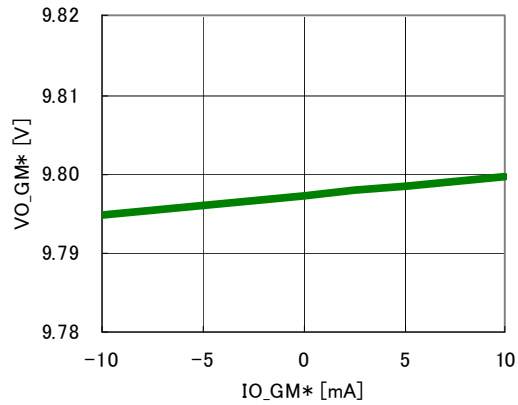

# R1293K

NO.EA-301-160107

## 37) DCDC Turn-on/Turn-off WaveForm by ENB

R1293KxxxA

R1293KxxxA

$V_{IN}=3.6V, V_{out}=V_{BUFF}=10V, f_{osc}=700kHz, SEL=0V, T_a=25^{\circ}C$   $V_{IN}=3.6V, V_{out}=V_{BUFF}=10V, f_{osc}=700kHz, SEL=0V, T_a=25^{\circ}C$

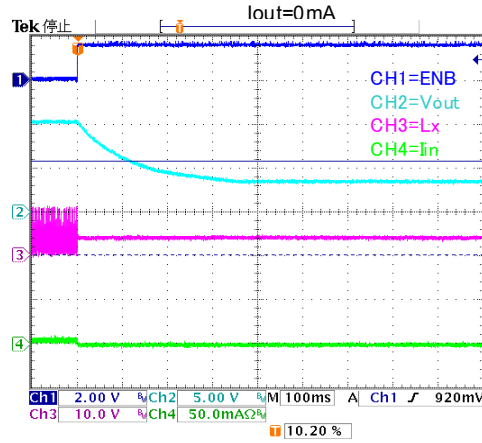
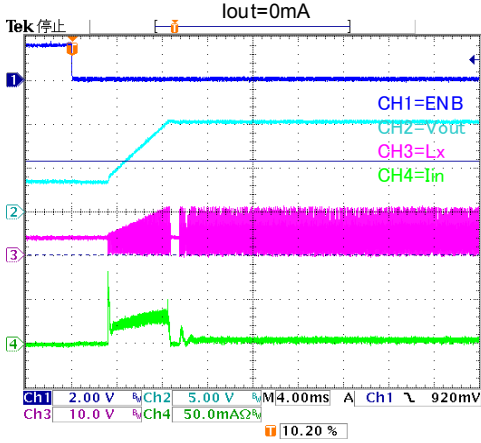

## 38) DCDC Turn-on/Turn-off WaveForm (DTC Soft Start) by VIN

R1293KxxxA

R1293KxxxA

$V_{IN}=3.6V, V_{out}=V_{BUFF}=10V, f_{osc}=700kHz, SEL=0V, T_a=25^{\circ}C$   $V_{IN}=3.6V, V_{out}=V_{BUFF}=10V, f_{osc}=700kHz, SEL=0V, T_a=25^{\circ}C$

$R_5=130k\Omega, C_{DTC}=0.22\mu F, I_{out}=0mA$

$R_5=130k\Omega, C_{DTC}=0.22\mu F, I_{out}=80mA$

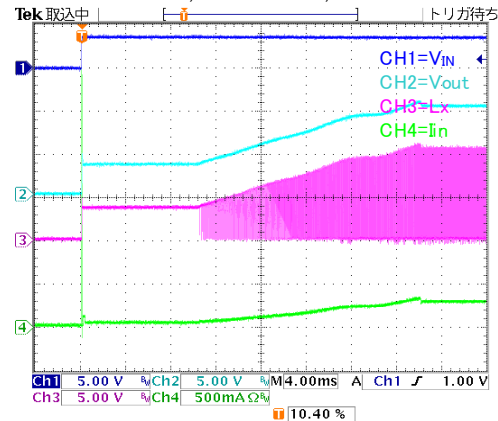
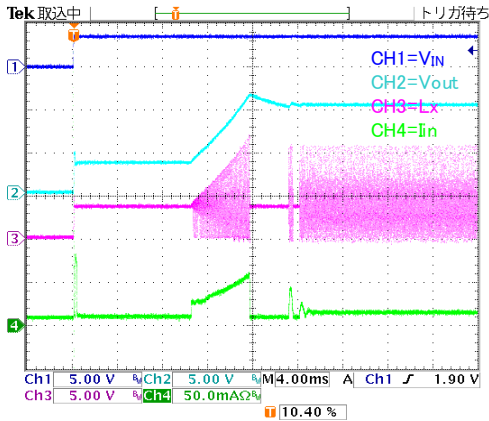

## 39) LDO Turn-on/Turn-off WaveForm by VIN

$V_{IN}=3.6V, V_{O\_LDO}=2.4V, T_a=25^{\circ}C$

$V_{IN}=3.6V, V_{O\_LDO}=2.4V, T_a=25^{\circ}C$

$I_{O\_LDO}=0mA$

$I_{O\_LDO}=0mA$

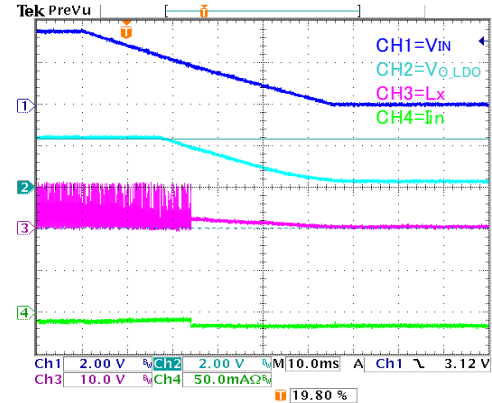
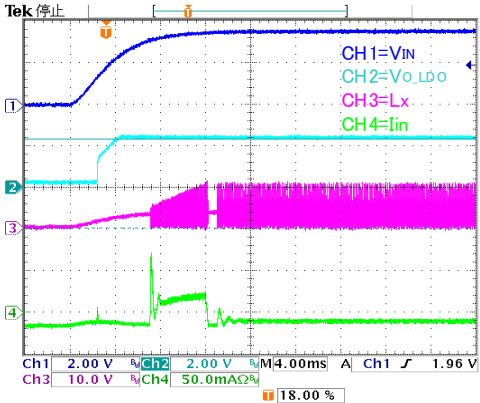

### 40) VCOM Turn-on/Turn-off WaveForm by ENB

$V_{IN}=3.6V$ ,  $V_{out}=V_{BUFF}=10V$ ,  $I_{N\_COM}=V_{BUFF}/2V$ ,  $SEL=0V$ ,  $T_a=25^{\circ}C$

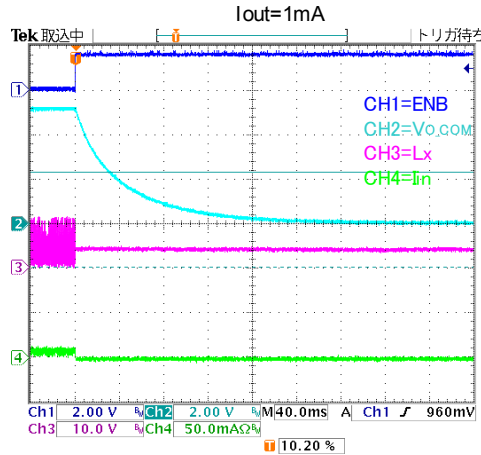
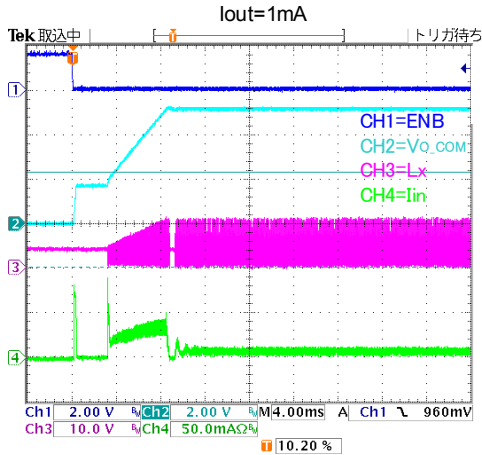

### 41) GAMMA Turn-on/Turn-off WaveForm by ENB

$V_{IN}=3.6V$ ,  $V_{out}=V_{BUFF}=10V$ ,  $I_{N\_GM}=V_{BUFF}/2V$ ,  $SEL=0V$ ,  $T_a=25^{\circ}C$

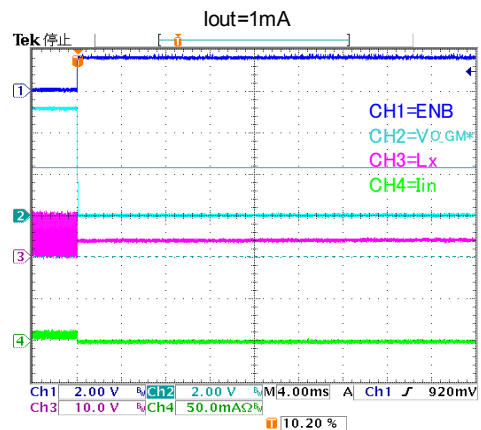
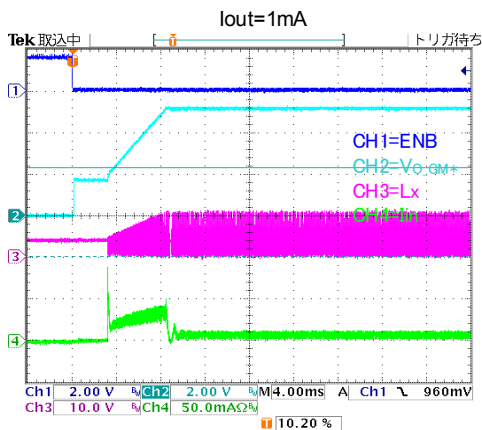

### 42) DCDC Load Tranjent Response

$V_{IN}=3.3V$ ,  $V_{out}=V_{BUFF}=10V$ ,  $f_{osc}=700kHz$ ,

$I_{OUT}=10mA \leftrightarrow 100mA$ ,  $SEL=0V$ ,  $T_a=25^{\circ}C$

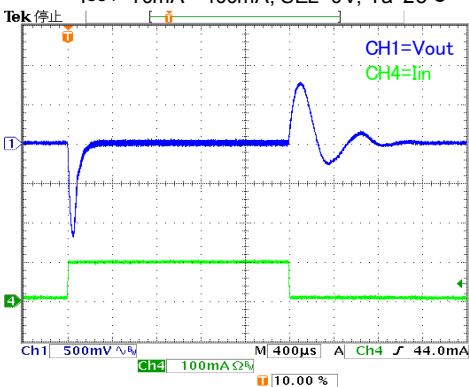

$V_{IN}=5.0V$ ,  $V_{out}=V_{BUFF}=10V$ ,  $f_{osc}=700kHz$ ,

$I_{OUT}=10mA \leftrightarrow 100mA$ ,  $SEL=0V$ ,  $T_a=25^{\circ}C$

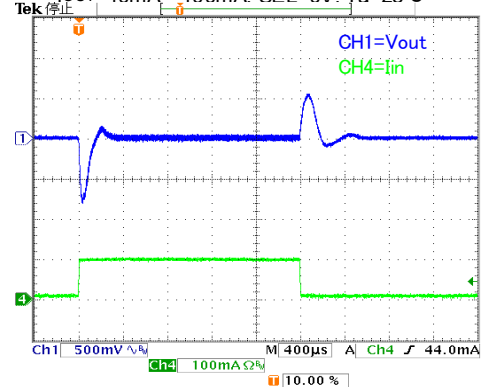

### 43) LDO Load Tranjent Response

$V_{IN}=2.9V, V_{O\_LDO}=2.4V$

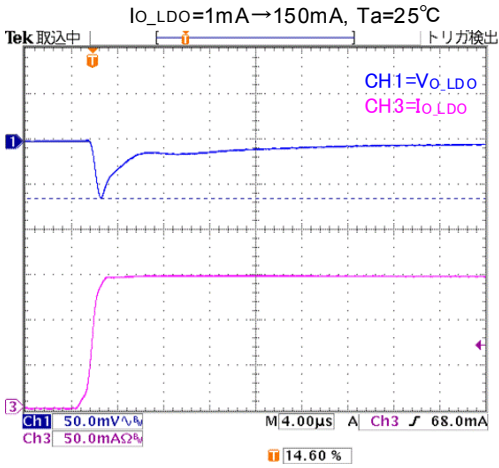

$V_{IN}=2.9V, V_{O\_LDO}=2.4V$

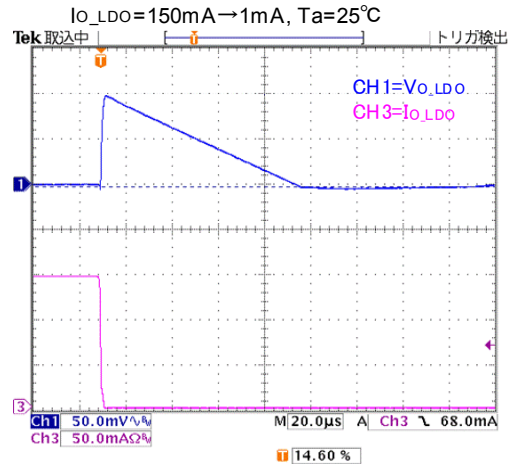

$V_{IN}=5.5V, V_{O\_LDO}=2.4V$

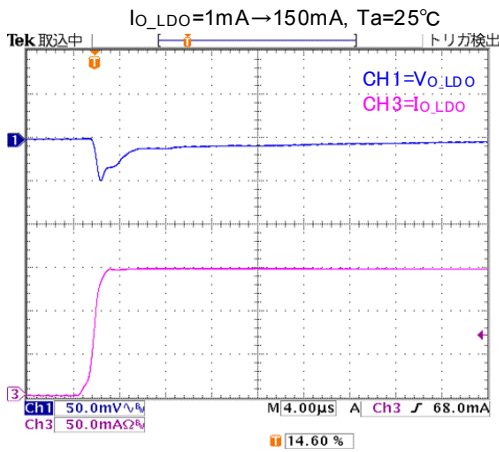

$V_{IN}=5.5V, V_{O\_LDO}=2.4V$

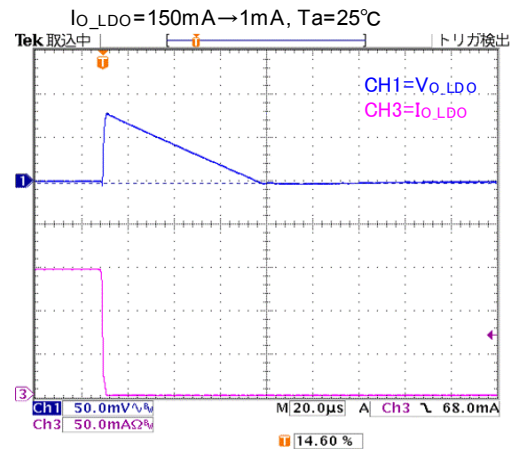

### 44) VCOM Load Tranjent Response

$V_{IN}=3.6V, V_{BUFF}=10V, I_{N\_COM}=V_{BUFF}/2V,$   
 $I_{O\_COM}=-10mA \leftrightarrow 10mA, T_a=25^\circ C$

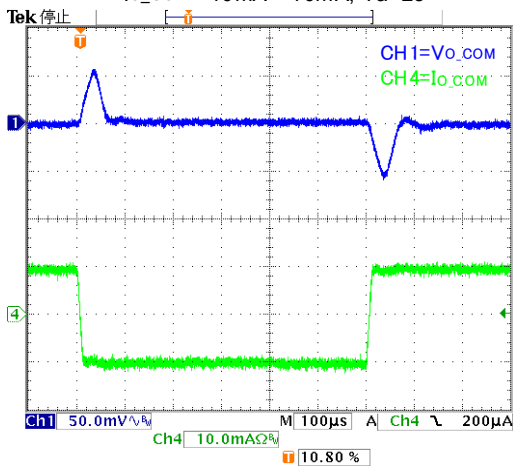

### 45) GAMMA Load Tranjent Response

$V_{IN}=3.6V, V_{BUFF}=10V, I_{N\_GM^*}=V_{BUFF}/2V,$   
 $I_{O\_GM^*}=-5mA \leftrightarrow 5mA, T_a=25^\circ C$

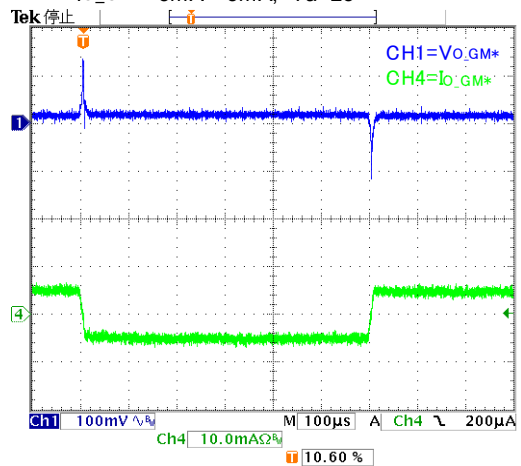



1. The products and the product specifications described in this document are subject to change or discontinuation of production without notice for reasons such as improvement. Therefore, before deciding to use the products, please refer to Ricoh sales representatives for the latest information thereon.
2. The materials in this document may not be copied or otherwise reproduced in whole or in part without prior written consent of Ricoh.
3. Please be sure to take any necessary formalities under relevant laws or regulations before exporting or otherwise taking out of your country the products or the technical information described herein.
4. The technical information described in this document shows typical characteristics of and example application circuits for the products. The release of such information is not to be construed as a warranty of or a grant of license under Ricoh's or any third party's intellectual property rights or any other rights.
5. The products listed in this document are intended and designed for use as general electronic components in standard applications (office equipment, telecommunication equipment, measuring instruments, consumer electronic products, amusement equipment etc.). Those customers intending to use a product in an application requiring extreme quality and reliability, for example, in a highly specific application where the failure or misoperation of the product could result in human injury or death (aircraft, spacevehicle, nuclear reactor control system, traffic control system, automotive and transportation equipment, combustion equipment, safety devices, life support system etc.) should first contact us.
6. We are making our continuous effort to improve the quality and reliability of our products, but semiconductor products are likely to fail with certain probability. In order to prevent any injury to persons or damages to property resulting from such failure, customers should be careful enough to incorporate safety measures in their design, such as redundancy feature, fire containment feature and fail-safe feature. We do not assume any liability or responsibility for any loss or damage arising from misuse or inappropriate use of the products.
7. Anti-radiation design is not implemented in the products described in this document.
8. Please contact Ricoh sales representatives should you have any questions or comments concerning the products or the technical information.



**Ricoh is committed to reducing the environmental loading materials in electrical devices with a view to contributing to the protection of human health and the environment.**

Ricoh has been providing RoHS compliant products since April 1, 2006 and Halogen-free products since April 1, 2012.

**RICOH** RICOH ELECTRONIC DEVICES CO., LTD.

<http://www.e-devices.ricoh.co.jp/en/>

#### Sales & Support Offices

##### **RICOH ELECTRONIC DEVICES CO., LTD.**

**Higashi-Shinagawa Office (International Sales)**  
3-32-3, Higashi-Shinagawa, Shinagawa-ku, Tokyo 140-8655, Japan  
Phone: +81-3-5479-2857 Fax: +81-3-5479-0502

##### **RICOH EUROPE (NETHERLANDS) B.V.**

**Semiconductor Support Centre**  
Prof. W.H. Keesomlaan 1, 1183 DJ Amstelveen, The Netherlands  
Phone: +31-20-5474-309

##### **RICOH INTERNATIONAL B.V. - German Branch**

**Semiconductor Sales and Support Centre**  
Oberrather Strasse 6, 40472 Düsseldorf, Germany  
Phone: +49-211-6546-0

##### **RICOH ELECTRONIC DEVICES KOREA CO., LTD.**

3F, Haesung Bldg, 504, Teheran-ro, Gangnam-gu, Seoul, 135-725, Korea  
Phone: +82-2-2135-5700 Fax: +82-2-2051-5713

##### **RICOH ELECTRONIC DEVICES SHANGHAI CO., LTD.**

Room 403, No.2 Building, No.690 Bibo Road, Pu Dong New District, Shanghai 201203, People's Republic of China  
Phone: +86-21-5027-3200 Fax: +86-21-5027-3299

##### **RICOH ELECTRONIC DEVICES CO., LTD.**

**Taipei office**  
Room 109, 10F-1, No.51, Hengyang Rd., Taipei City, Taiwan (R.O.C.)  
Phone: +886-2-2313-1621/1622 Fax: +886-2-2313-1623

# Mouser Electronics

Authorized Distributor

Click to View Pricing, Inventory, Delivery & Lifecycle Information:

[Ricoh Electronics:](#)

[R1293K241A-E2](#)



Компания «Life Electronics» занимается поставками электронных компонентов импортного и отечественного производства от производителей и со складов крупных дистрибьюторов Европы, Америки и Азии.

С конца 2013 года компания активно расширяет линейку поставок компонентов по направлению коаксиальный кабель, кварцевые генераторы и конденсаторы (керамические, пленочные, электролитические), за счёт заключения дистрибьюторских договоров

Мы предлагаем:

- Конкурентоспособные цены и скидки постоянным клиентам.
- Специальные условия для постоянных клиентов.
- Подбор аналогов.
- Поставку компонентов в любых объемах, удовлетворяющих вашим потребностям.
- Приемлемые сроки поставки, возможна ускоренная поставка.
- Доставку товара в любую точку России и стран СНГ.
- Комплексную поставку.
- Работу по проектам и поставку образцов.
- Формирование склада под заказчика.
- Сертификаты соответствия на поставляемую продукцию (по желанию клиента).
- Тестирование поставляемой продукции.
- Поставку компонентов, требующих военную и космическую приемку.
- Входной контроль качества.
- Наличие сертификата ISO.

В составе нашей компании организован Конструкторский отдел, призванный помогать разработчикам, и инженерам.

Конструкторский отдел помогает осуществить:

- Регистрацию проекта у производителя компонентов.
- Техническую поддержку проекта.
- Защиту от снятия компонента с производства.
- Оценку стоимости проекта по компонентам.
- Изготовление тестовой платы монтаж и пусконаладочные работы.



Тел: +7 (812) 336 43 04 (многоканальный)  
Email: [org@lifeelectronics.ru](mailto:org@lifeelectronics.ru)