

FPER48Txyz30*A

36-75Vdc Input, 30A, 1.2-3.3Vdc Output

The **SENSE²** Series of isolated dc-dc converters deliver exceptional electrical and thermal performance in industry-standard footprints for isolated brick converters. These are the converters of choice for Intermediate Bus Architecture (IBA) and Distributed Power Architecture (DPA) applications that require high efficiency and high reliability in elevated temperature environments with low airflow.

絶縁型ブリックDC/DCコンバータの **SENSE²** シリーズは業界標準のピン配列で、極めて優れた電気的特性、及び温度特性を提供します。このコンバータは、高温、及び風量の少ない環境で高効率、高信頼性が要求されるIBA、又はDPAでの使用に最適です。

The **FPER48Txyz30*A** converters of the **SENSE²** Series are eighth brick converters that operate from a 36Vdc to 75Vdc input and provide tightly regulated standard output voltages from 1.2V to 3.3V. They deliver up to 30A of output current. Their thermal performance is excellent: no derating is needed up to 75°C with 400LFM airflow.

SENSE² シリーズの **FPER48Txyz30*A**は36V~75V入力で動作し、1.2V~3.3Vの高い標準出力電圧精度を備えたエイズブリックコンバータです。30Aを出力可能です。**FPER48Txyz30*A**は優れた温度特性を持っています。400LFMの条件で75°Cまでデレーティングを必要としません。

This leading edge thermal performance results from electrical, thermal and packaging design that is optimized for high density circuit card conditions. Extremely high quality and reliability are achieved through advanced circuit and thermal design techniques and FDK's state of the art in-house manufacturing processes and systems.

回路設計、放熱設計、及びパッケージング設計の結果である最先端の温度特性は、高密度実装回路用に最適化されています。非常に優れた品質と信頼性は高度な回路設計、温度設計技術、及びFDKの最先端の自社製造プロセスによりもたらされます。

Applications

- Intermediate Bus Architecture
中間バス構成システム
- Telecommunications
テレコムシステム
- Data/Voice processing
データ処理システム
- Distributed Power Architecture
分散型電源システム
- Computing (Servers, Workstations)
コンピュータ関係(サーバー、ワークステーション)

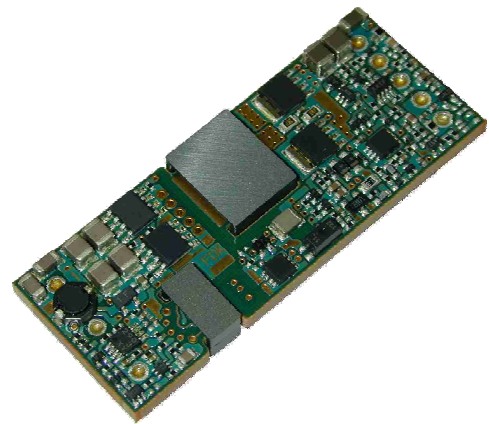

FPER48Txyz30*A

Features

- RoHS compliant RoHS準拠
- Delivers up to 30A (99W)
30A (99W)まで供給可能
- Outputs available: 1.2, 1.5, 1.8, 2.5 and 3.3Vdc
供給可能出力電圧: 1.2, 1.5, 1.8, 2.5, 3.3Vdc
- Industry-standard eighth brick footprint and pinout
業界標準の1/8ブリック フットプリントとピン配列
- Small size and low profile: 2.30" x 0.898" x 0.421"
小型および低背(58.4 x 22.8 x 10.7mm)
- No minimum load required 最小負荷は不要
- Start up into pre-biased output
出力にプリバイアスがあっても起動可能
- Meets basic insulation requirements of EN60950
- Input to output isolation: 1500Vdc
入出力間の絶縁: 1500Vdc
- Positive or negative logic remote ON/OFF option
- Fully protected: OCP, OTP, OVP, UVLO
保護機能: 過電流、加熱、過電圧、低電圧ロックアウト
- Remote output voltage sense
- Output voltage trim (+10%/-20%) using industry-standard trim equations
- High reliability, MTBF = 3.5 Million Hours (@30°C)
高信頼性: MTBF = 3.5 Million Hours (@30°C)
- UL60950 recognition in U.S. & Canada, and CB Scheme certification per IEC/EN60950
UL60950、CB Scheme 認証
- All materials meet UL94, V-0 flammability rating
全ての部品は UL94 V-0に適合
- Meets conducted emissions requirements of FCC Class B and EN55022 Class B with external filter
外部フィルター付きの状態でのFCCクラスB、及びEN55022クラスBを満足します。

FPER48Txyz30*A

36-75Vdc Input, 30A, 1.2-3.3Vdc Output

Electrical Specifications 電氣的仕様

Specifications apply over specified input voltage, output load, and temperature range, unless otherwise noted.

注記が無い場合、仕様は指定された入力電圧、負荷、温度範囲で適用されます。

Conditions: $T_a=25\text{degC}$, Airflow=300LFM (1.5m/s), $V_{in}=48\text{Vdc}$, unless otherwise specified.

PARAMETER	NOTES	MIN	TYP	MAX	UNITS
ABSOLUTE MAXIMUM RATINGS¹					
Input Voltage	Continuous	0		80	Vdc
Operating Temperature	Ambient temperature	-40		85	°C
Storage Temperature		-55		125	°C
ISOLATION					
Isolation Voltage		1500			Vdc
Isolation Resistance		10			MΩ
Isolation Capacitance			220		pF
INPUT CHARACTERISTICS					
Operating Input Voltage Range	Continuous	36	48	75	Vdc
Input Under Voltage Lockout					
Turn-on Threshold		33	34	36	Vdc
Turn-off Threshold		31	32	33	Vdc
Input Voltage Transient	100mS			100	Vdc
Maximum Input Current	30Adc out, @36Vdc in				
	Vout=3.3 VDC			3.3	Adc
	Vout=2.5 VDC			2.5	Adc
	Vout=1.8 VDC			1.9	Adc
	Vout=1.5 VDC			1.6	Adc
	Vout=1.2 VDC			1.3	Adc
Input Stand-by Current (module disabled)	$V_{in} = 48\text{V}$, converter disabled		25		mA
Input No Load Current (module disabled)	$V_{in} = 48\text{V}$, converter enabled				
	Vout=3.3 VDC		55		mA
	Vout=2.5 VDC		45		mA
	Vout=1.8 VDC		40		mA
	Vout=1.5 VDC		40		mA
	Vout=1.2 VDC		40		mA
Input Reflected-Ripple Current, i_s	Full load, 10μH source inductance				
	Vout=3.3 VDC		2		mAp-p
	Vout=2.5 VDC		2		mAp-p
	Vout=1.8 VDC		2		mAp-p
	Vout=1.5 VDC		2		mAp-p
	Vout=1.2 VDC		2		mAp-p

¹Absolute Maximum Ratings 絶対最大定格

¹Stresses in excess of the absolute maximum ratings and operation beyond the rated current as specified by the derating curves may lead to degradation in performance and reliability of the converter and may result in permanent damage.

絶対最大定格を超えたストレスとデレーティングカーブにより規定された定格電流を超えた動作は、性能の低下、長期信頼性の低下、及びモジュールの破損を引き起こすことがあります。

FPER48Txyz30*A

36-75Vdc Input, 30A, 1.2-3.3Vdc Output

Electrical Specifications (Continued) 電氣的仕様 (続き)

Conditions: $T_a=25\text{degC}$, Airflow=300LFM (1.5m/s), $V_{in}=48\text{Vdc}$, unless otherwise specified.

PARAMETER	NOTES	MIN	TYP	MAX	UNITS
OUTPUT CHARACTERISTICS					
Output Voltage Range (Over all operating input voltage, resistive load and temperature conditions)		-1.5		+1.5	%
Load Regulation	Co=10 μ F tantalum + 1 μ F ceramic		± 2	± 5	mV
Output Ripple and Noise BW=20MHz	Co=10 μ F tantalum + 1 μ F ceramic		50		mVp-p
External Load Capacitance	Plus full load (resistive)			20,000	μ F
Output Current Range		0		30	A
Output Current Limit Inception (I _{out})		31.5	36.5	42	A
Output Short-Circuit Current	Short=10m Ω		15		Arms
Transient Response 50%-75% load step change with di/dt=5A/ μ s	Co=470 μ F os-con + 10 μ F tantalum + 1 μ F ceramic		150		mV
Efficiency	100% Load (30A)				
	V _{out} =3.3 VDC		90.0		%
	V _{out} =2.5 VDC		88.0		%
	V _{out} =1.8 VDC		85.5		%
	V _{out} =1.5 VDC		84.0		%
	V _{out} =1.2 VDC		82.0		%
	50% Load (15A)				
	V _{out} =3.3 VDC		91.0		%
	V _{out} =2.5 VDC		90.0		%
	V _{out} =1.8 VDC		87.5		%
	V _{out} =1.5 VDC		86.0		%
	V _{out} =1.2 VDC		84.0		%
FEATURE CHARACTERISTICS					
Switching Frequency	Output		500		kHz
Turn-On Delay Time	with V _{in} and Enable.		5		ms
Rise Time (Full resistive load)	From 0.1*V _{out} (nom) to 0.9*V _{out} (nom)		5		ms
ON/OFF Control (Negative Logic)					
Module Off		2.5		20	Vdc
Module On		-0.5		0.8	Vdc
ON/OFF Control (Positive Logic)					
Module Off		-0.5		0.8	Vdc
Module On		2.5		20	Vdc

FPER48Txyz30*A

36-75Vdc Input, 30A, 1.2-3.3Vdc Output

Operation

Input and Output Impedance

Inductance associated with input and output power lines can affect the stability of the **FPER48Txyz30*A** converter. The addition of a 100 μ F electrolytic capacitor with an ESR < 1 Ω across the input will help to ensure stability of the converter in many applications. To cover applications where decoupling capacitance is needed at the load, the converter has been designed to exhibit stable operation with external load capacitance up to 20,000 μ F.

入力、及び出力ラインのインダクタンスは**FPER48Txyz30*A**の安定動作に大きな影響があります。多くのアプリケーションで入力ラインにESRが1 Ω 未満の100 μ F電解コンデンサを付けることでコンバータの安定動作が可能です。負荷端にデカップリングコンデンサが付くアプリケーションでは、20,000 μ Fまで安定して動作するように設計されています。

To minimize output ripple voltage, the use of very low ESR ceramic capacitors is recommended. These capacitors should be placed in close proximity to the load to improve transient performance and to decrease output voltage ripple.

出力リップルを最小にするため、極低ESRのセラミックコンデンサの接続を推奨します。過渡時の特性向上と出力リップル低減のために負荷の近傍にこれらのコンデンサを実装することをお勧めします。

ON/OFF (Pin 2)

The ON/OFF pin (Pin 2) can be used to turn the converter on or off remotely using a signal that is referenced to $V_{in(-)}$ (Pin 3). Two remote control options are available, corresponding to positive and negative logic. A typical configuration for remote ON/OFF is shown in Fig. A.

ON/OFF端子(2番ピン)は $V_{in(-)}$ (3番ピン)を基準としたリモート信号によりコンバータをON/OFFするのに使用できます。リモートコントロールはポジティブとネガティブの2種類が可能です。一般的なリモートON/OFF回路を図-Aに示します。

In the positive logic version the converter turns on when the ON/OFF pin is at logic high (open) and turns off when it is at logic low. When the ON/OFF pin is left open, the converter is on. Voltage ranges for logic high/low are provided in the Electrical Specifications section.

ポジティブロジックはON/OFFピンが論理的にHigh (open)で動作し、論理的にLowで停止します。ON/OFFピンが未接続(オープン)の場合、コンバータはONします。論理的High/Lowの電圧範囲は電気的特性を参照してください。

In the negative logic version the converter turns on when the ON/OFF pin is at logic low and turns off when it is at logic high (open). If the ON/OFF pin is connected directly (shorted) to $V_{in(-)}$, the converter will turn on without the need for a control signal.

ネガティブロジックはON/OFFピンが論理的にLowで動作し、論理的にHigh (open)で停止します。ON/OFFピンが $V_{in(-)}$ に接続されている場合、コントロール信号が無くてもコンバータはONします。

The ON/OFF pin is pulled up internally. A mechanical switch, open-collector transistor, or FET can be used to drive the ON/OFF pin. The device must be capable of sinking up to 0.2mA at a voltage $\leq 0.8V$. An external voltage source (+20V maximum), capable of sourcing or sinking up to 1mA depending on the polarity, can also be used to drive the ON/OFF pin.

ON/OFFピンはモジュール内部でプルアップされています。ON/OFFピンを駆動するために機械的スイッチ、オープンコレクタートランジスタ、又はFETを使用可能です。使用する部品は0.8V以下の電圧で0.2mAまで電流を流せる必要があります。1mAまで流せる外部電源(最大+20V)がON/OFFピンを駆動するのに使用可能です。

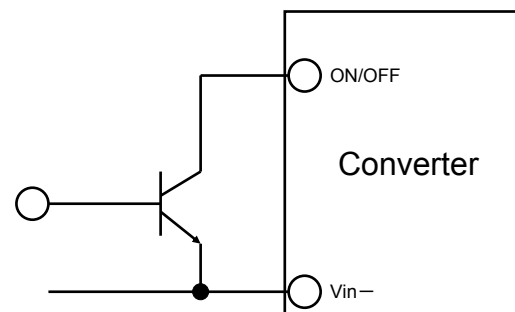

Fig A: A typical configuration for remote ON/OFF

FPER48Txyz30*A

36-75Vdc Input, 30A, 1.2-3.3Vdc Output

Remote Sense (Pins 5 and 7)

To compensate for voltage drops that occur between the output pins of the converter and the point of regulation (typically, the load), the SENSE(-) (Pin 5) and SENSE(+) (Pin 7) pins should be connected across the load or at the point where regulation is needed (see Fig. B).

コンバータの出力端子と電圧制御が必要なポイント(通常負荷端)との間で発生する電圧降下を補正するためには、SENSE(-) (Pin 5) と SENSE(+) (Pin 7) を負荷側か、又は電圧精度が必要なポイントに接続します。(図B参照)

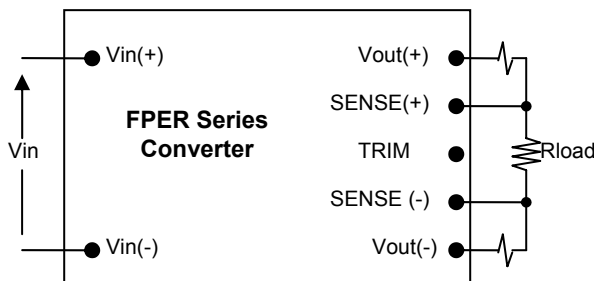

Fig. B: Circuit configuration for remote sense

If remote sensing is not necessary, the SENSE(-) pin should be connected to the Vout(-) pin (Pin 4), and the SENSE(+) pin should be connected to the Vout(+) pin (Pin 8) to ensure proper regulation of the converter output voltage. If the SENSE pins are left open, the converter will regulate at an output voltage that is slightly higher than specified.

リモートセンスが必要でないなら、SENSE(-)ピンはVout(-) (4番ピン) と、SENSE(+)ピンはVout(+) (8番ピン) に接続し、出力電圧の電圧精度を確実にします。SENSEピンが接続されていないと出力電圧は規定の値よりわずかに上昇します。

To minimize noise pick-up, traces from the SENSE pins to the load should be located in proximity to a ground plane. If wiring discretely, a twisted pair is recommended.

ノイズの影響を最小に抑えるため、センスピンから負荷への配線はグラウンド配線に近くしてください。もし線材で直接配線する場合は、ツイストペア線の使用をお勧めします。

Note that the output over-voltage protection (OVP) feature of the converter depends on the voltage across the Vout(+) and Vout(-) pins, and not across the SENSE pins. To preclude unnecessary triggering of the OVP feature, the resistance (and thus voltage drop) between the output pins of the converter and the load should be kept at a minimum.

このコンバータの出力電圧保護(OVP)はVout(+)とVout(-)間の電圧に依存し、センスピン間の電圧には依存しません。OVPの予期せぬトリガを防ぐために、コンバータの出力端子と負荷間の抵抗成分(電圧ドロップ)は最小にしてください。

Note that the remote sense function will allow the voltage across the output pins to be higher than the nominal output voltage, in order to maintain regulation at the load. The system design should take this into account to ensure that the power drawn from the converter under a given set of conditions does not exceed the maximum output power of the converter. For any given ambient conditions, the maximum output power of the converter is the product of the maximum output current, as defined by the derating curves, and the nominal output voltage.

リモートセンス機能は負荷端での電圧を制御するため、出力端の電圧を通常よりも高くします。システムの設計では本件に留意し、コンバータの出力電力が最大定格電力を超えないように注意してください。いずれの外部条件においてもコンバータの最大定格電力はデレーティングカーブに記載された最大出力電流と出力電圧で規定されます。

FPER48Txyz30*A

36-75Vdc Input, 30A, 1.2-3.3Vdc Output

Output Voltage Adjust/TRIM (Pin 6)

The output voltage can be trimmed up 10% or down 20% relative to the nominal output voltage using an external resistor.

出力電圧は外部抵抗を接続する事で、定格電圧に対し +10%、-20%の調整が可能です。

The TRIM pin should be left open if trimming is not being used. Note that a 0.1μF capacitor is connected internally between the TRIM and SENSE(-) pins, to minimize noise pick-up.

TRIM ピンは出力電圧のトリミングを使わなければ未接続にしておきます。微小のノイズを拾わないように、コンバータ内部でTRIM端子と SENSE(-)端子間に0.1μFのコンデンサが接続されています。

To trim the output voltage up (Fig. C), a trim resistor, R_{T-UP}, should be connected between the TRIM (Pin 6) and SENSE(+)(Pin 7):

出力電圧を上昇させる(トリムアップ)には (図C参照)、トリム抵抗 R_{T-UP} を TRIM(Pin 6)と SENSE(+)(Pin 7)間に接続します。

$$R_{T-UP} = \frac{5.11(100 + \Delta)V_{O-NOM}}{V_{ref} \Delta} - \frac{511}{\Delta} - 10.22 \text{ [k}\Omega\text{]}$$

$$V_{ref} = 1.225V \quad [3.3V \text{ to } 1.5V]$$

$$V_{ref} = 1.0V \quad [1.2V]$$

where,

R_{T-UP} = Required value of trim-up resistor [kΩ]

V_{O-NOM} = Nominal value of output voltage [V]

$$\Delta = \frac{(V_{O-REQ} - V_{O-NOM})}{V_{O-NOM}} \times 100 \text{ [%]}$$

V_{O-REQ} = Desired (trimmed) output voltage [V]

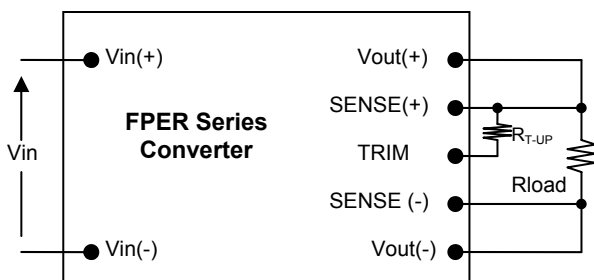

Fig. C: Configuration for trimming output voltage up

When trimming up, care should be taken not to exceed the maximum output power of the converter, as discussed in the previous section.

出力電圧を上昇させる(トリムアップ)場合、前章での説明のようにコンバータの最大定格電力を超えないように注意してください。

To trim the output voltage down (Fig.D), a trim resistor, R_{T-DWN}, should be connected between the TRIM (Pin 6) and SENSE(-) (Pin 5):

出力電圧を下げる(トリムダウン)には (図D参照)、トリム抵抗 R_{T-DWN} を TRIM(Pin 6)と SENSE(-)(Pin 5)間に接続します。

$$R_{T-DWN} = \frac{511}{|\Delta|} - 10.22 \text{ [k}\Omega\text{]}$$

where,

R_{T-DWN} = Required value of trim-down resistor [kΩ]

And Δ is as defined above.

The above equations are standard in the industry for isolated brick converters.

上記のトリム抵抗値の計算方法は絶縁型ブリックコンバータで業界標準です。

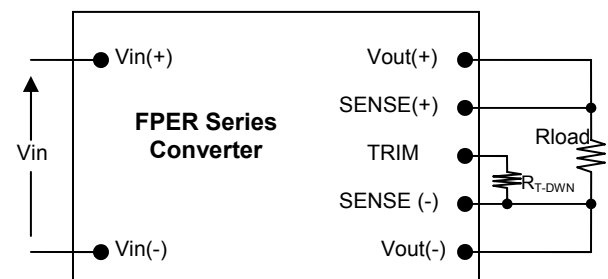

Fig. D: Configuration for trimming output voltage down

Note that trimming up or sensing above 10% of the nominal output voltage could cause unnecessary triggering of the output over-voltage protection (OVP). The voltage of between converter's output pins with remote sense should not exceed 110% of nominal output voltage:

$$[V_{out(+)} - V_{out(-)}] \leq [V_{out(Nominal)} \times 110\%] \text{ [V]}$$

定格出力電圧の10%を超えるトリムアップ、又は電圧センサは、不必要な過電圧保護(OVP)の検出の原因となります。

リモートセンス時のコンバータの出力端子間電圧が定格出力電圧の110%を超えない様にして下さい。

FPER48Txyz30*A

36-75Vdc Input, 30A, 1.2-3.3Vdc Output

Protection Features

Input Under-Voltage Lockout

From a turned-on state, the converter will turn off automatically when the input voltage drops below typically 32V. It will then turn on automatically when the input voltage reaches typically 34V.

動作している状態で、入力電圧がTYPで32V未満になるとコンバータは自動的に停止します。また、入力電圧がTYPで34V以上になるとコンバータは自動的に動作を開始します。

Output Over-Current Protection (OCP)

The converter is self-protected against over-current and short circuit conditions. On the occurrence of an over-current condition, the converter will reduce the output voltage until it shuts down. Once the converter has shut down, it will attempt to restart about every 200ms until the over-current or short circuit condition is removed.

このコンバータは過電流と負荷短絡に対し自己保護します。過電流状態になると、コンバータはシャットダウンするまで出力電圧を低下させます。コンバータがシャットダウン後、OCP状態、又は負荷短絡が解除されるまで およそ200ms毎に再起動を繰り返します。

Output Over-Voltage Protection (OVP)

The converter provides protection against over-voltage conditions at the output. It will shut down if the voltage across the output pins exceeds a threshold defined by the independently-referenced OVP circuitry. Once the converter has shut down, it will attempt to restart about every 200ms until the OVP condition is removed.

このコンバータは出力端の過電圧を保護します。出力端の電圧がOVP回路として独立した基準値で決められたしきい値を超えるとシャットダウンします。コンバータがシャットダウンすると、過電圧状態が解除されるまでおよそ200ms毎に再起動を繰り返します。

Over-Temperature Protection (OTP)

The converter is self-protected against over-temperature conditions. In case of overheating due to abnormal operation conditions, the converter will turn off automatically. It will turn back on automatically once it has cooled down to a safe temperature (auto-reset).

このコンバータは加熱保護機能を有しています。異常な動作条件によって加熱状態になると、このコンバータは自動的に停止します。安全な温度にまで下がると自動的に復帰します。(自動リセット)

Safety Requirements

The **FPER48Txyz30*A** converter is provided with basic insulation between input and output circuits according to IEC60950 standards. It features 1500Vdc isolation from input to output, and input-to-output resistance is greater than 10MΩ.

FPER48Txyz30*AはIEC60950準拠で入力-出力間が基礎絶縁されています。また、入力-出力間は1500Vdcの耐圧を有しており、絶縁抵抗は10MΩ以上あります。

This converter meets North American and International safety regulatory requirements per UL60950 and EN60950.

このコンバータは北米及び国際的な安全基準であるUL60950とEN60950に適合しています。

Note that the converter is not internally fused: to meet safety requirements, a fast acting in-line fuse with a maximum rating in the table below must be used in the positive input line.

このコンバータは内部にヒューズを持っていませんので、安全規格に適合させるためには、入力ラインのプラス側に即断型で最大定格下表のヒューズを接続してください。

Output Voltage	Fuse Rating
3.3V	5A
2.5V	4A
1.8V	3A
1.5V	2.5A
1.2V	2A

FPER48Txyz30*A

36-75Vdc Input, 30A, 1.2-3.3Vdc Output

Characterization

Overview

The converter has been characterized for several operational features, including thermal derating (maximum available load current as a function of ambient temperature and airflow), efficiency, power dissipation, start-up and shutdown characteristics, ripple and noise, and transient response to load step-changes.

このコンバータは温度デレーティング、効率、電力損失、スタートアップ時、及びシャットダウン時の動作、リップル・ノイズ、動的負荷変動などを含む、さまざまな動作状態で特徴付けられます。データ、及び波形の図は以後のページに掲載されています。

Figures showing data plots and waveforms for different output voltages are presented in the following pages. The figures are numbered as Fig.*V-#, where *V indicates the output voltage, and # indicates a particular plot type for that voltage. For example, Fig.*V-2 is a plot of efficiency vs. load current for any output voltage *V.

各出力電圧時のデータ、及び波形の図は以後のページに掲載されています。図はFig.*V-#のように番号付けされており、*Vは出力電圧を表し、#は特定のプロットを表します。例えば Fig.*V-2とあれば、*V出力での効率特性を表します。

Test Conditions

To ensure measurement accuracy and reproducibility, all thermal and efficiency data were taken with the converter soldered to a standardized thermal test board. The thermal test board was mounted inside FDK's custom wind tunnel to enable precise control of ambient temperature and airflow conditions.

測定精度、及び再現性を確実にするために、全ての温度、及び効率データは標準化された温度評価ボードにコンバータを半田付けして取得しています。温度評価ボードをFDK特製の風洞実験設備内に設置することで、環境温度、及び風量を精密に管理しています。

The thermal test board comprised a four layer printed circuit board (PCB) with a total thickness of 0.060". Copper metallization on the two outer layers was limited to pads and traces needed for soldering the converter and peripheral components to the board. The two inner layers comprised power and ground planes of 2 oz. copper. This thermal test board, with the paucity of copper on the outer surfaces, limits heat transfer from the converter to the PCB, thereby providing a worst-case but consistent set of conditions for thermal measurements.

温度評価ボードは厚さ0.060"(1.6mm)厚の4層PCBで作成しています。表面2層の銅箔はコンバータを実装するためのパッドと周辺部品へのパターンのみ限定しています。内側2層は70μmの銅箔で電力、及びグランドラインを形成しています。このように表層の銅箔を限りなく少なくした温度評価ボードは、コンバータからPCBへの熱の逃げを制限し、ワーストケースでありながら矛盾の無い温度評価条件を実現しています。

FDK's custom wind tunnel was used to provide precise horizontal laminar airflow in the range of 50 LFM to 600LFM, at ambient temperatures between 30°C and 85°C. Infrared (IR) thermography and thermocouples were used for temperature measurements. (See Fig. E & Fig. F)

FDKオリジナルの風洞実験装置は水平方向の層流を50LFM(自然対流と同等、NC)から600LFMまで精密に制御でき、環境温度は30°Cから85°Cを制御できます。温度測定には赤外線(IR)サーモグラフィと熱電対を使用しています。(図E、及び図F参照)

It is advisable to check the converter temperature in the actual application, particularly if the application calls for loads close to the maximums specified by the derating curves. IR thermography or thermocouples may be used for this purpose. In the latter case, AWG#40 gauge thermocouples are recommended to minimize interference and measurement error. Optimum locations for placement of thermocouples are indicated in Fig. G.

コンバータの温度を実際の使用環境で測定することをお勧めします。特に実用上の負荷が温度デレーティングの最大値に近い場合は測定が必要です。温度測定には赤外線サーモグラフィ、又は熱電対をお使いいただけます。熱電対を使用する場合、風の妨げになることを防ぐためと、測定誤差を少なくするため、AWG40の熱電対を推奨します。熱電対での測定に最適な箇所は図Gに示します



Fig. E: FDK Original Wind Tunnel

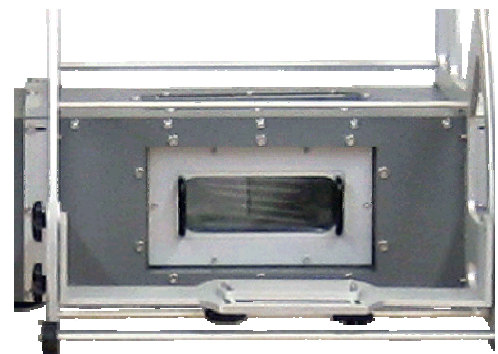

Fig. F: Test Chamber

FPER48Txyz30*A

36-75Vdc Input, 30A, 1.2-3.3Vdc Output

Thermal Derating

Fig.*V-1 shows the maximum available load current vs. ambient temperature and airflow rates. Ambient temperature was varied between 30°C and 85°C, with airflow rates from 100 LFM to 500 LFM (0.5 m/s to 2.5 m/s). The converter was mounted horizontally, and the airflow was parallel to the short axis of the converter, going from pin 1 to pin 3.

図*V-1はある環境温度と風量の条件下における最大出力電流を表します。環境温度は風量100LFM～500LFMの条件で30°C～85°Cの間を変動させています。コンバータは水平に設置し、風向きはコンバータの短手方向に平行で1ピンから3ピンに向けて吹いています。

The maximum available load current, for any given set of conditions, is defined as the lower of:

- (i) The output current at which the temperature of any component reaches 125°C, or
- (ii) The current rating of the converter (30A)

A maximum component temperature of 125°C should not be exceeded in order to operate within the derating curves. Thus, the temperature at the thermocouple locations shown in Fig. G should not exceed 125°C in normal operation.

各々の測定条件で最大出力電流の値は下記のとおり定義します。

- (i) いずれかの部品の温度が125°Cの到達した時点の出力電流値、又は
- (ii) コンバータの公称定格電流 (30A)

温度デレーティングの範囲内で動作させるために、部品温度は125°Cを超えないようにご注意ください。従って、通常動作時に図Gに示す位置の熱電対の温度が125°Cを超えないようにしてください。

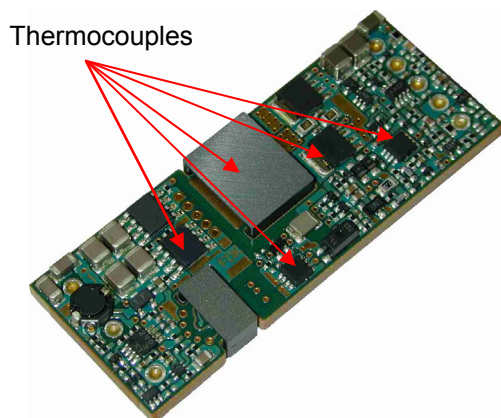

Fig. G: Location of thermocouples for thermal testing

Efficiency

Fig.*V-2 shows efficiency vs. load current at an ambient temperature of 25°C, airflow of 300LFM (1.5m/s) with horizontal mounting and input voltages of 36V, 48V and 75V.

図*V-2は環境温度25°C、風量300LFM (1.5m/s)、水平実装、入力電圧36V、48V、及び75V時における負荷電流と効率のプロットです。

Power dissipation

Fig.*V-3 shows power dissipation vs. load current at an ambient temperature of 25°C, airflow of 300LFM (1.5m/s) with horizontal mounting and input voltages of 36V, 48V and 72V.

図*V-3は環境温度25°C、風量300LFM (1.5m/s)、水平実装、入力電圧36V、48V、及び72V時における負荷電流と電力消費のプロットです。

Start-up

Fig.*V-4 and Fig.*V-5 show turn-on output voltage waveforms, using the ON/OFF pin, for full rated load currents (resistive load), with minimal and maximum external load capacitance.

最大負荷(抵抗負荷)でON/OFFピンによる起動時について、外部コンデンサ有りとなしとの出力電圧立ち上がり波形を図*V-4、及び図*V-5に示します。

Transient Response

Fig.*V-6 shows the output voltage response to a step change in the load current.

図*V-6は負荷電流の変動に対する出力電圧応答を示します。

Ripple and Noise

Fig.*V-7 shows the output voltage ripple waveform, measured at full rated load current with a 10µF tantalum capacitor and 1µF of ceramic capacitors across the output.

図*V-7は最大負荷で出力端子間に10µFのタンタルコンデンサと1µFのセラミックコンデンサを付けた状態で測定した出力リップル電圧波形を示します。

Fig.*V-9 and Fig.*V-10 show input reflected ripple current waveforms, obtained using the test setup shown in Fig.*V-8.

入力反射リップルは図*V-8に示す試験セットアップを使って観測しています。入力反射リップル波形は図*V-9、及び図*V-10に示します。

FPER48Txyz30*A

36-75Vdc Input, 30A, 1.2-3.3Vdc Output

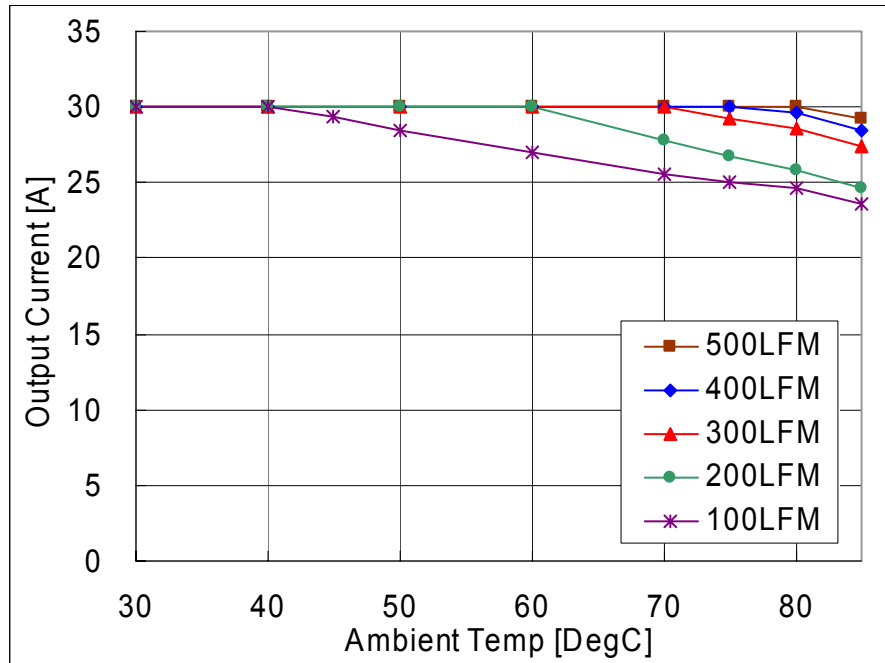

Fig.3.3V-1: Available load current vs. ambient temperature and airflow rates for Vin=48V. Maximum component temperature $\leq 125^{\circ}\text{C}$

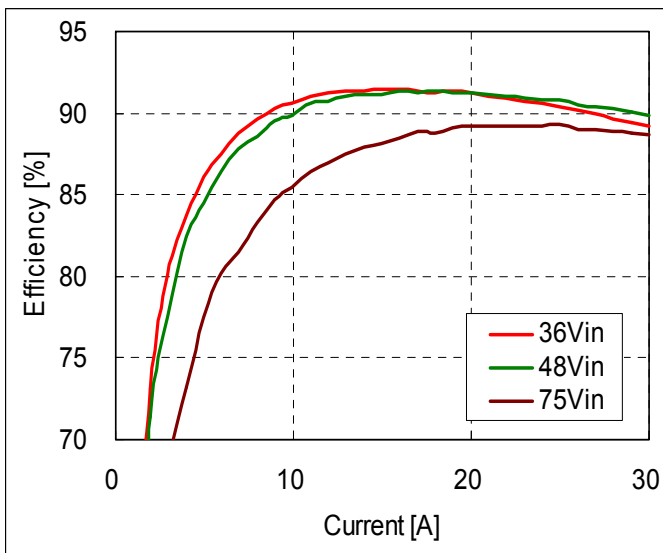

Fig.3.3V-2: Efficiency vs. load current and input voltage for converter mounted horizontally with airflow from pin 3 to pin 1 at a rate of 300LFM (1.5m/s) and Ta=25°C.

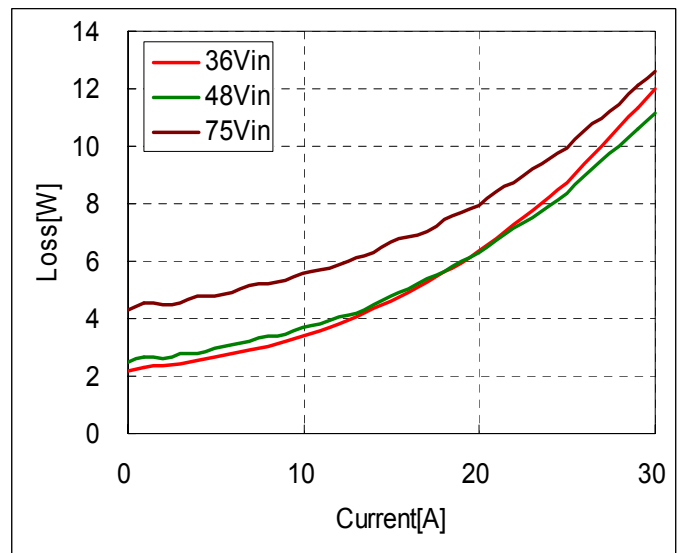

Fig.3.3V-3: Power Loss vs. load current and input voltage for converter mounted horizontally with airflow from pin 3 to pin 1 at a rate of 300LFM (1.5m/s) and Ta=25°C.

FPER48Txyz30*A

36-75Vdc Input, 30A, 1.2-3.3Vdc Output

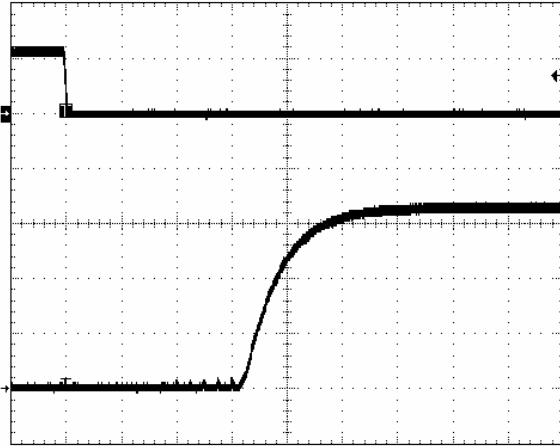

Fig.3.3V-4: Turn-on transient at full rated load current (resistive) with 10 μ F tantalum + 1 μ F ceramic capacitor at Vin=48V, triggered via ON/OFF pin. Top trace: ON/OFF signal (10V/div). Bottom trace: output voltage (1V/div). Time scale: 2ms/div

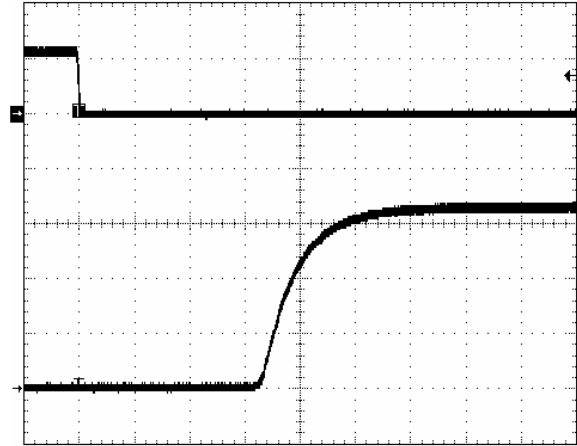

Fig.3.3V-5: Turn-on transient at full rated load current (resistive) plus 20,000 μ F at Vin=48V, triggered via ON/OFF pin. Top trace: ON/OFF signal (10V/div). Bottom trace: output voltage (1V/div). Time scale: 2ms/div

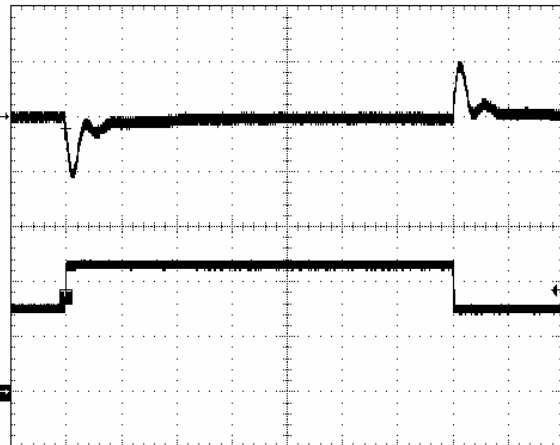

Fig.3.3V-6: Output voltage response to load current step-change (15A \leftrightarrow 22.5A) at Vin=48V. Top trace: Output voltage (100mV/div). Bottom trace: load current (10A/div). Current slew rate: 5A/ μ s. Co=470 μ F os-con + 10 μ F tantalum + 1 μ F ceramic. Time scale: 100 μ s/div

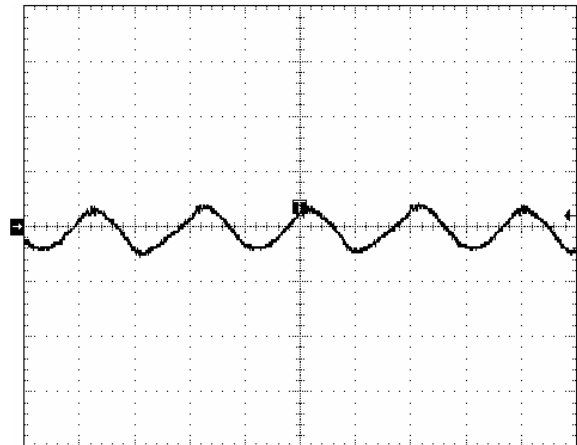

Fig.3.3V-7: Output voltage ripple (50mV/div) at full rated load current into a resistive load with Co=10 μ F tantalum + 1 μ F ceramic and Vin=48V. Time scale: 1 μ s/div

FPER48Txyz30*A

36-75Vdc Input, 30A, 1.2-3.3Vdc Output

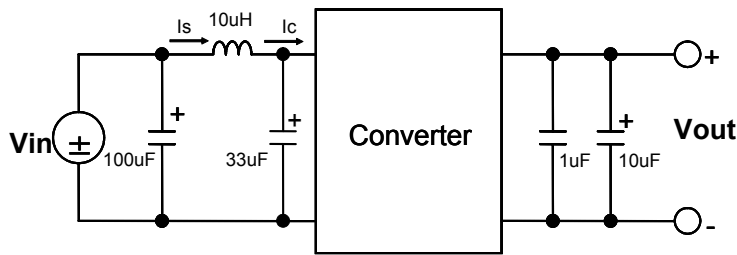

Fig.3.3V-8: Test Set-up for measuring input reflected ripple current.

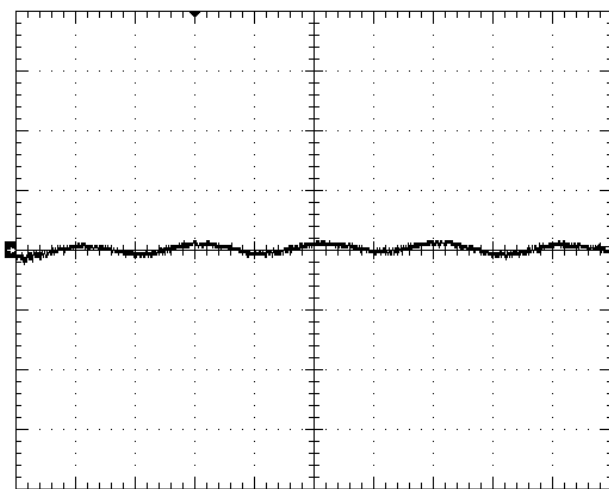

Fig.3.3V-9: Input reflected ripple current, I_s (5mA/div), measured through 10µH at the source at full rated load current and $V_{in}=48V$. Time scale: 1µs/div.

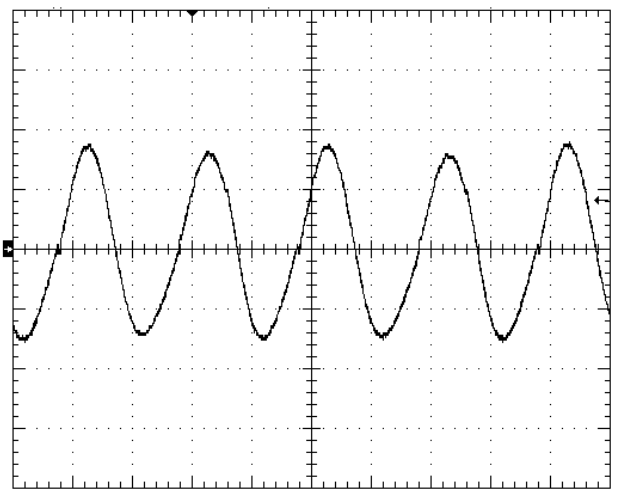

Fig.3.3V-10: Input reflected ripple current, I_c (100mA/div), measured through 10µH at the source at full rated load current and $V_{in}=48V$. Time scale: 1µs/div.

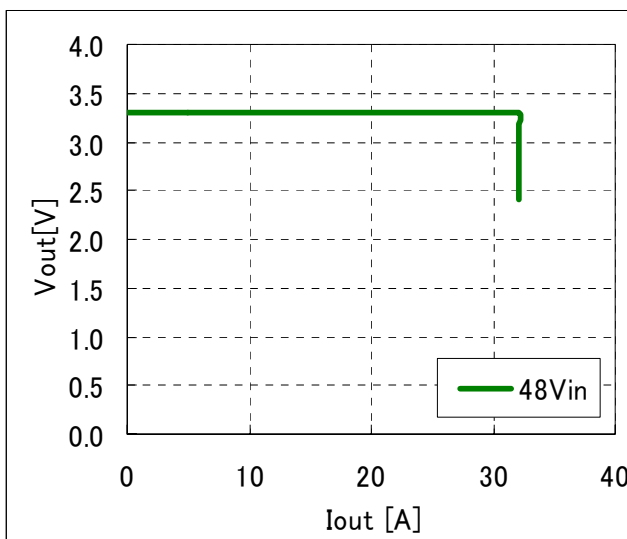

Fig.3.3V-11: Output voltage vs. load current showing current limit point and converter shutdown point. ($V_{in} = 48V$)

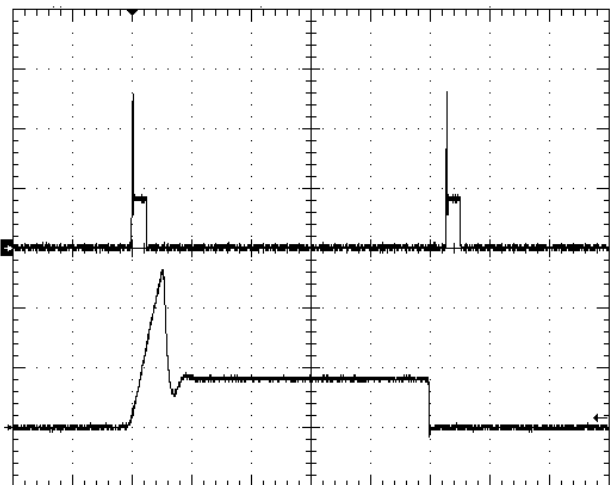

Fig.3.3V-12: Load current (top trace, 50A/div, 40ms/div) into a 10mΩ short circuit during restart, at $V_{in} = 48V$. Bottom trace (50A/div, 2ms/div) is an expansion of the top trace.

FPER48Txyz30*A

36-75Vdc Input, 30A, 1.2-3.3Vdc Output

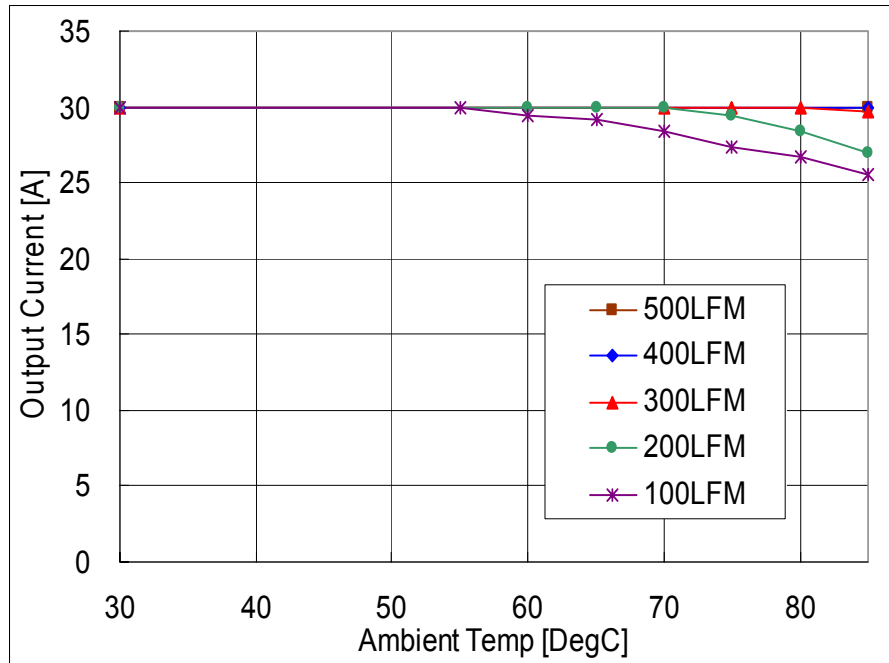

Fig.2.5V-1: Available load current vs. ambient temperature and airflow rates for Vin=48V. Maximum component temperature $\leq 125^{\circ}\text{C}$

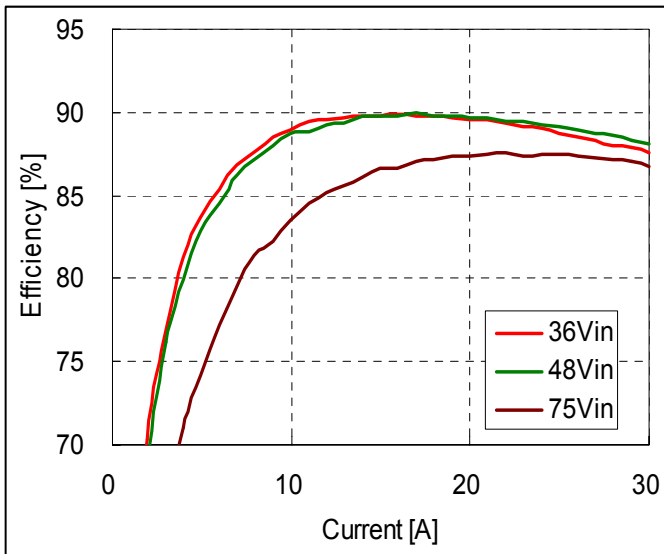

Fig.2.5V-2: Efficiency vs. load current and input voltage for converter mounted horizontally with airflow from pin 3 to pin 1 at a rate of 300LFM (1.5m/s) and Ta=25°C.

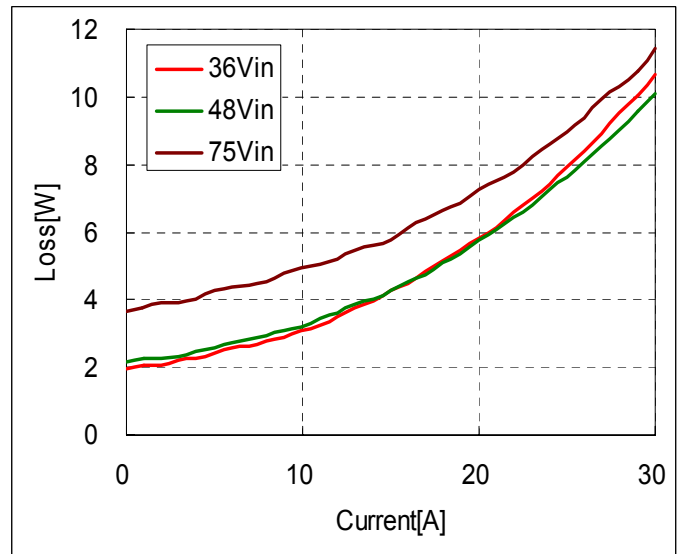

Fig.2.5V-3: Power dissipation vs. load current and input voltage for converter mounted horizontally with airflow from pin 3 to pin 1 at a rate of 300LFM (1.5m/s) and Ta=25°C.

FPER48Txyz30*A

36-75Vdc Input, 30A, 1.2-3.3Vdc Output

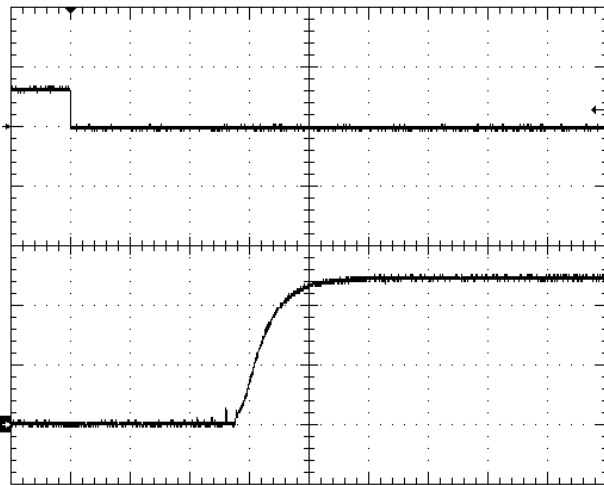

Fig.2.5V-4: Turn-on transient at full rated load current (resistive) with 10µF tantalum + 1µF ceramic capacitor at Vin=48V, triggered via ON/OFF pin. Top trace: ON/OFF signal (5V/div). Bottom trace: output voltage (1V/div). Time scale: 2ms/div

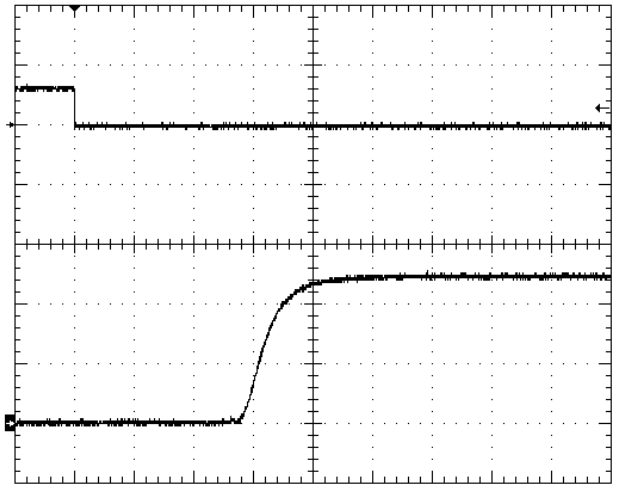

Fig.2.5V-5: Turn-on transient at full rated load current (resistive) plus 20,000µF at Vin=48V, triggered via ON/OFF pin. Top trace: ON/OFF signal (5V/div). Bottom trace: output voltage (1V/div). Time scale: 2ms/div

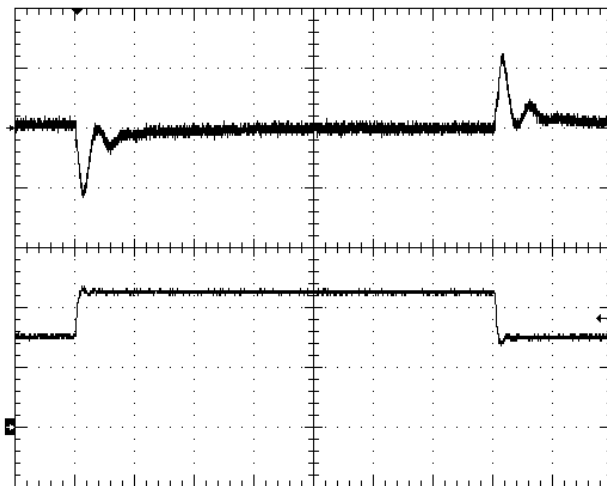

Fig.2.5V-6: Output voltage response to load current step-change (15⇌22.5A) at Vin=48V. Top trace: Output voltage (100mV/div). Bottom trace: load current (10A/div). Current slew rate: 5A/µs. Co=470µF os-con + 10µF tantalum + 1µF ceramic. Time scale: 100µs/div

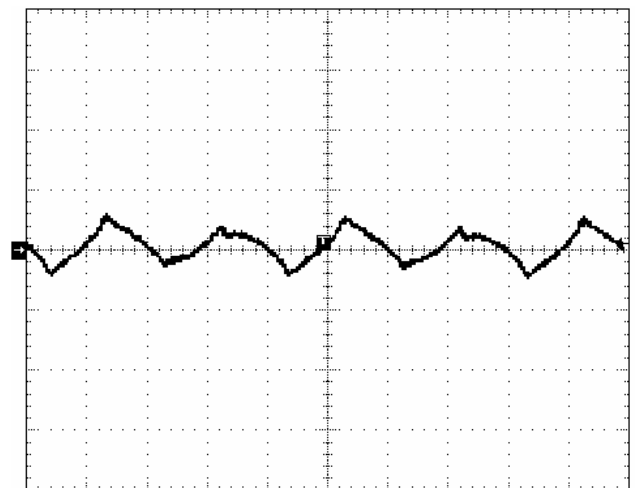

Fig.2.5V-7: Output voltage ripple (50mV/div) at full rated load current into a resistive load with Co=10µF tantalum + 1µF ceramic and Vin=48V. Time scale: 1µs/div

FPER48Txyz30*A

36-75Vdc Input, 30A, 1.2-3.3Vdc Output

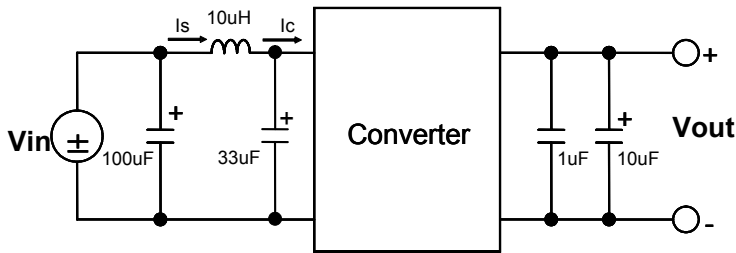

Fig.2.5V-8: Test Set-up for measuring input reflected current.

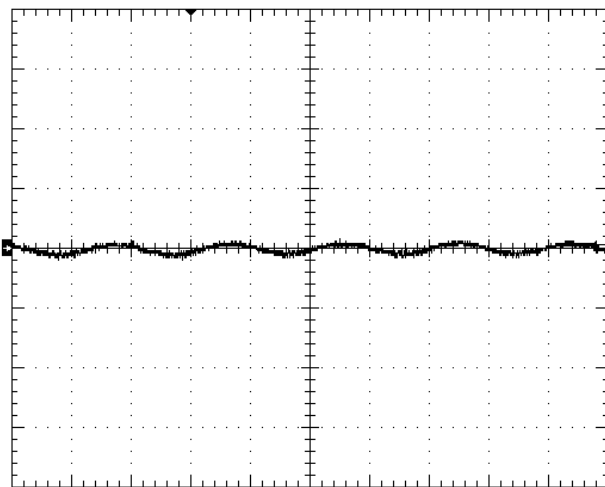

Fig.2.5V-9: Input reflected ripple current, I_s (5mA/div), measured through 10 μ H at the source at full rated load current and $V_{in}=48V$. Time scale: 1 μ s/div.

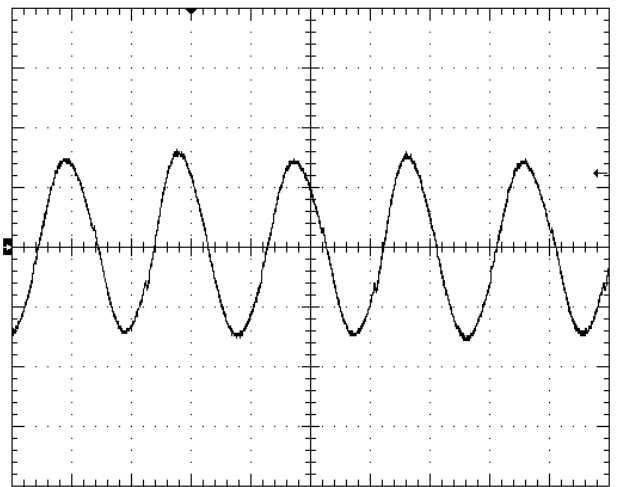

Fig.2.5V-10: Input reflected ripple current, I_c (100mA/div), measured through 10 μ H at the source at full rated load current and $V_{in}=48V$. Time scale: 1 μ s/div.

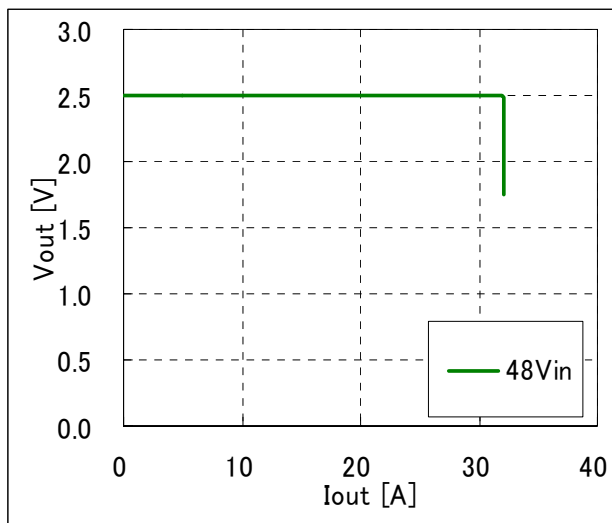

Fig.2.5V-11: Output voltage vs. load current showing current limit point and converter shutdown point. ($V_{in} = 48V$)

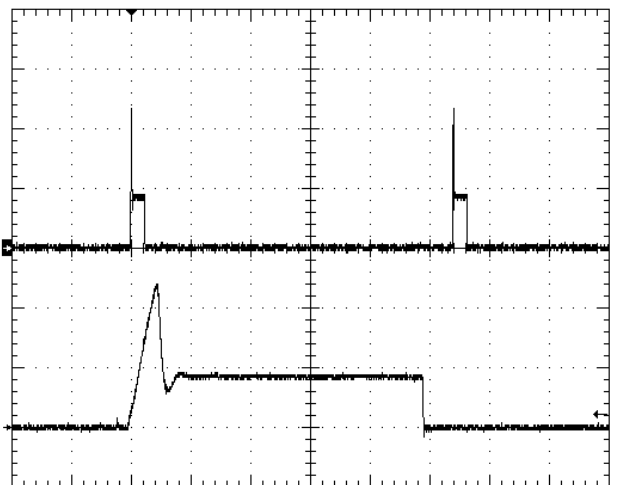

Fig.2.5V-12: Load current (top trace, 50A/div, 40ms/div) into a 10m Ω short circuit during restart, at $V_{in} = 48V$. Bottom trace (50A/div, 2ms/div) is an expansion of the top trace.

FPER48Txyz30*A

36-75Vdc Input, 30A, 1.2-3.3Vdc Output

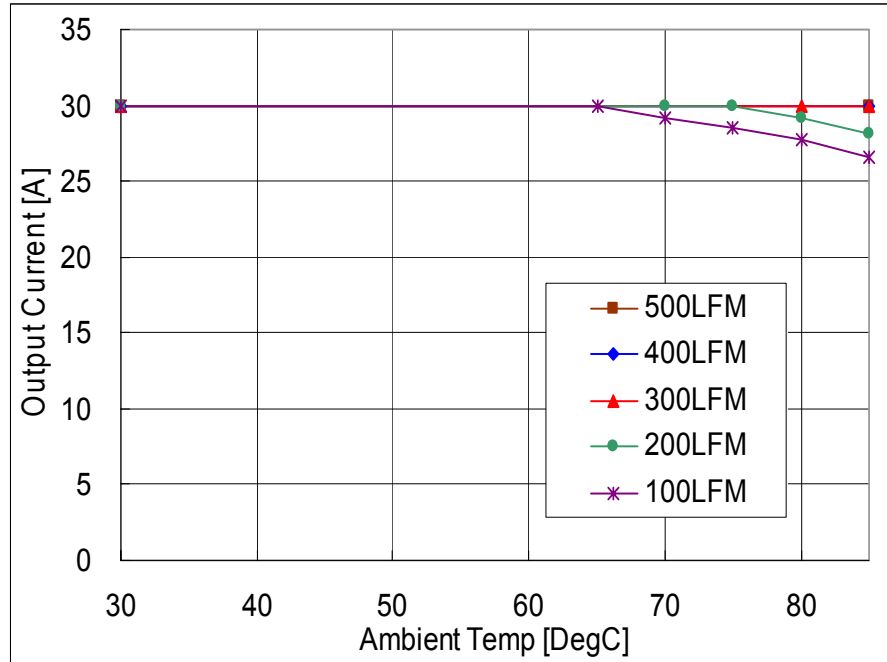

Fig.1.8V-1: Available load current vs. ambient temperature and airflow rates for Vin=48V. Maximum component temperature $\leq 125^{\circ}\text{C}$

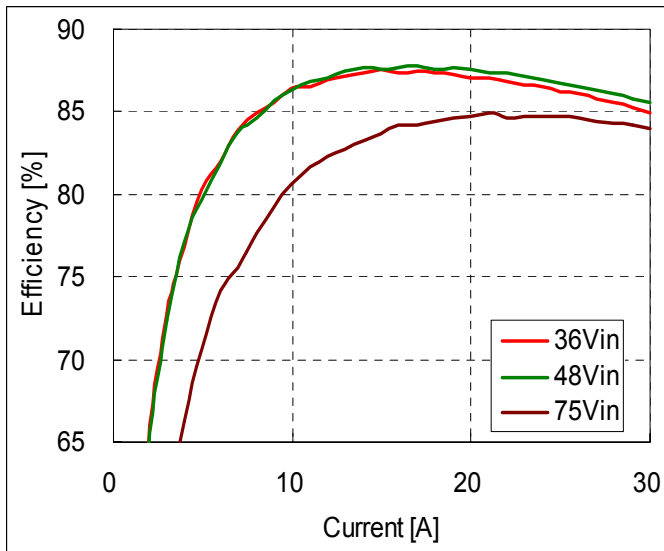

Fig.1.8V-2: Efficiency vs. load current and input voltage for converter mounted horizontally with airflow from pin 3 to pin 1 at a rate of 300LFM (1.5m/s) and Ta=25°C.

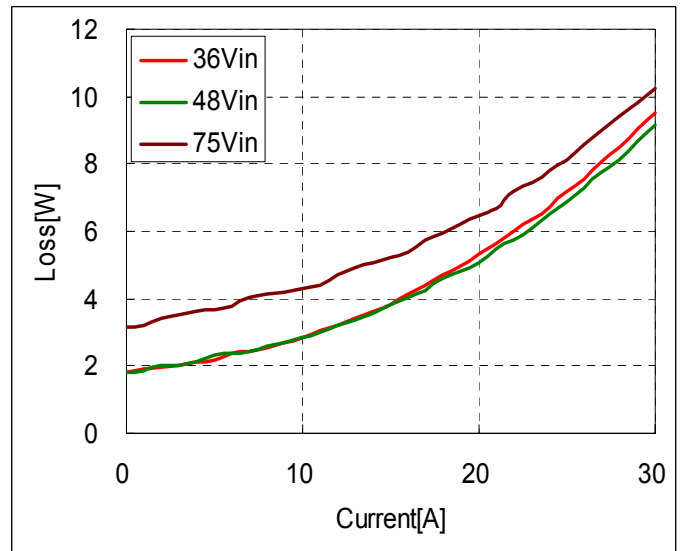

Fig.1.8V-3: Power dissipation vs. load current and input voltage for converter mounted horizontally with airflow from pin 3 to pin 1 at a rate of 300LFM (1.5m/s) and Ta=25°C.

FPER48Txyz30*A

36-75Vdc Input, 30A, 1.2-3.3Vdc Output

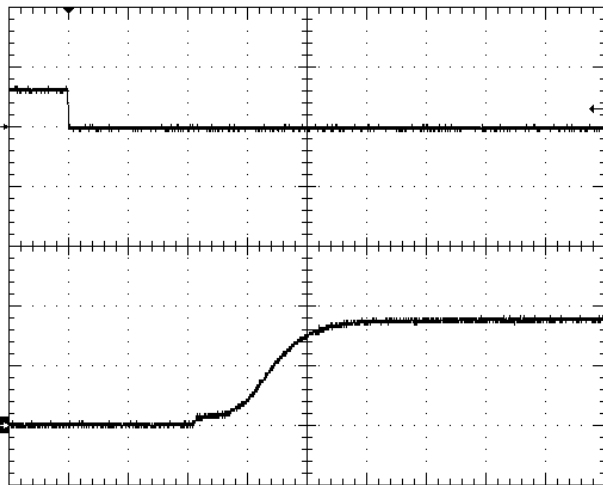

Fig.1.8V-4: Turn-on transient at full rated load current (resistive) with 10µF tantalum + 1µF ceramic capacitor at Vin=48V, triggered via ON/OFF pin. Top trace: ON/OFF signal (5V/div). Bottom trace: output voltage (1V/div). Time scale: 2ms/div

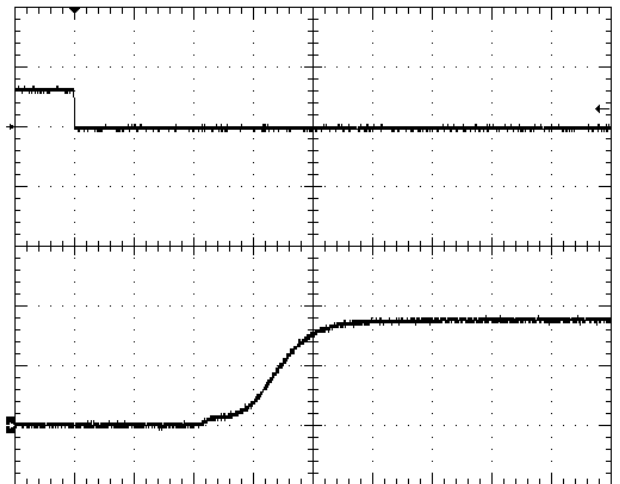

Fig.1.8V-5: Turn-on transient at full rated load current (resistive) plus 20,000µF at Vin=48V, triggered via ON/OFF pin. Top trace: ON/OFF signal (5V/div). Bottom trace: output voltage (1V/div). Time scale: 2ms/div

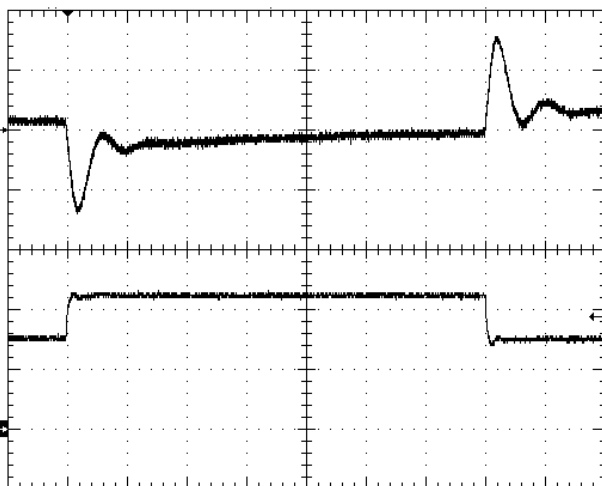

Fig.1.8V-6: Output voltage response to load current step-change (15⇌22.5A) at Vin=48V. Top trace: Output voltage (100mV/div). Bottom trace: load current (10A/div). Current slew rate: 5A/µs. Co=470µF os-con + 10µF tantalum + 1µF ceramic. Time scale: 100µs/div

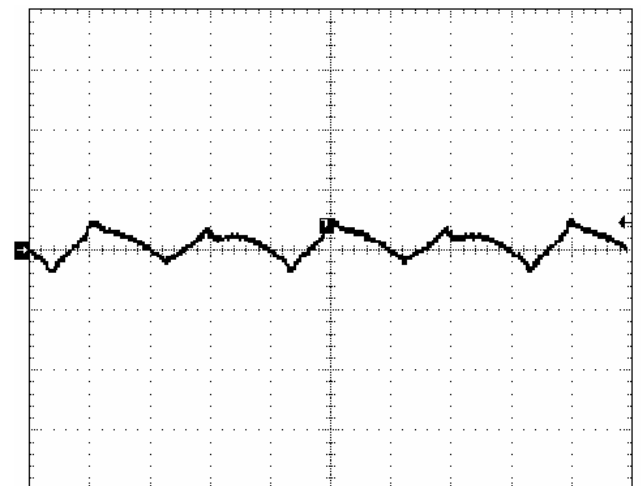

Fig.1.8V-7: Output voltage ripple (50mV/div) at full rated load current into a resistive load with Co=10µF tantalum + 1µF ceramic and Vin=48V. Time scale: 1µs/div

FPER48Txyz30*A

36-75Vdc Input, 30A, 1.2-3.3Vdc Output

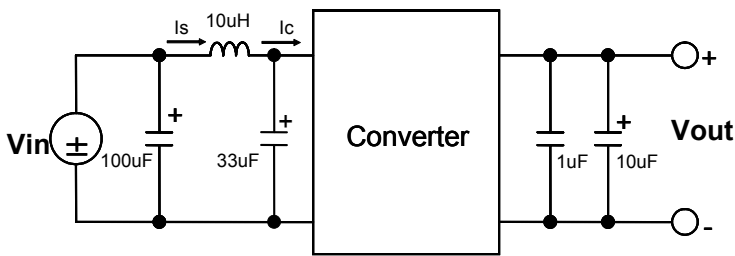

Fig.1.8V-8: Test Set-up for measuring input reflected ripple current.

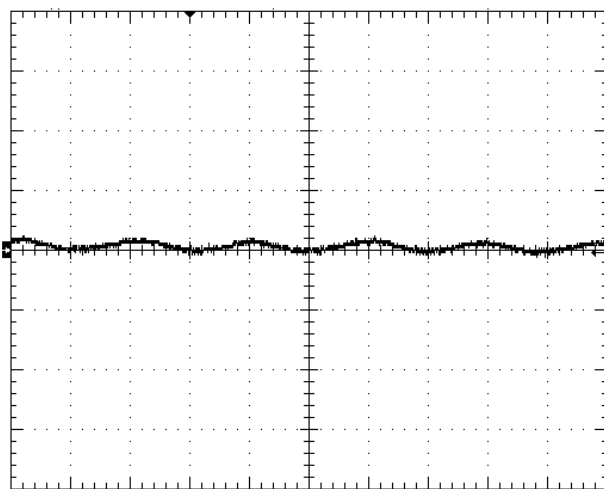

Fig.1.8V-9: Input reflected ripple current, I_s (5mA/div), measured through 10µH at the source at full rated load current and $V_{in}=48V$. Time scale: 1µs/div.

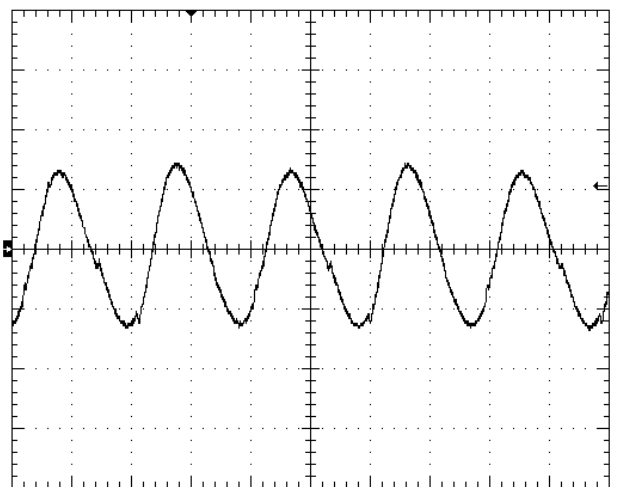

Fig.1.8V-10: Input reflected ripple current, I_c (100mA/div), measured through 10µH at the source at full rated load current and $V_{in}=48V$. Time scale: 1µs/div.

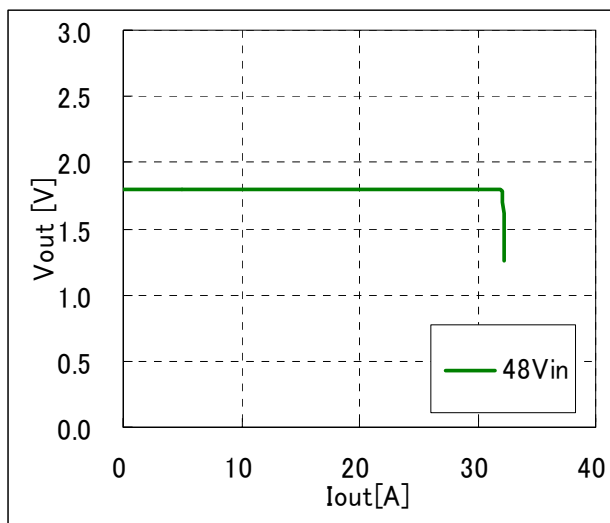

Fig.1.8V-11: Output voltage vs. load current showing current limit point and converter shutdown point. ($V_{in} = 48V$)

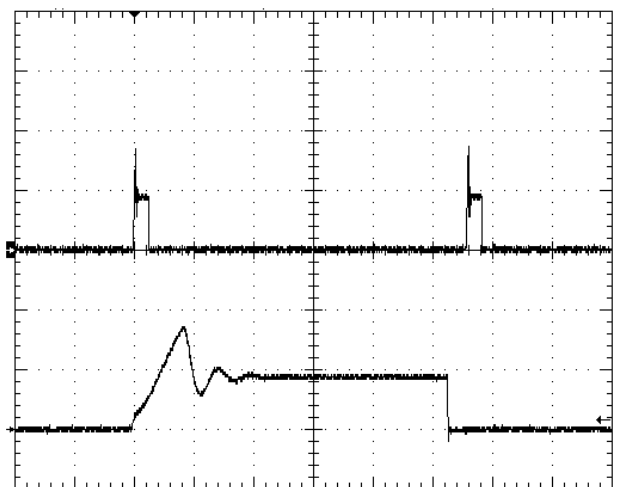

Fig.1.8V-12: Load current (top trace, 50A/div, 20ms/div) into a 10mΩ short circuit during restart, at $V_{in} = 48V$. Bottom trace (50A/div, 5ms/div) is an expansion of the top trace.

FPER48Txyz30*A

36-75Vdc Input, 30A, 1.2-3.3Vdc Output

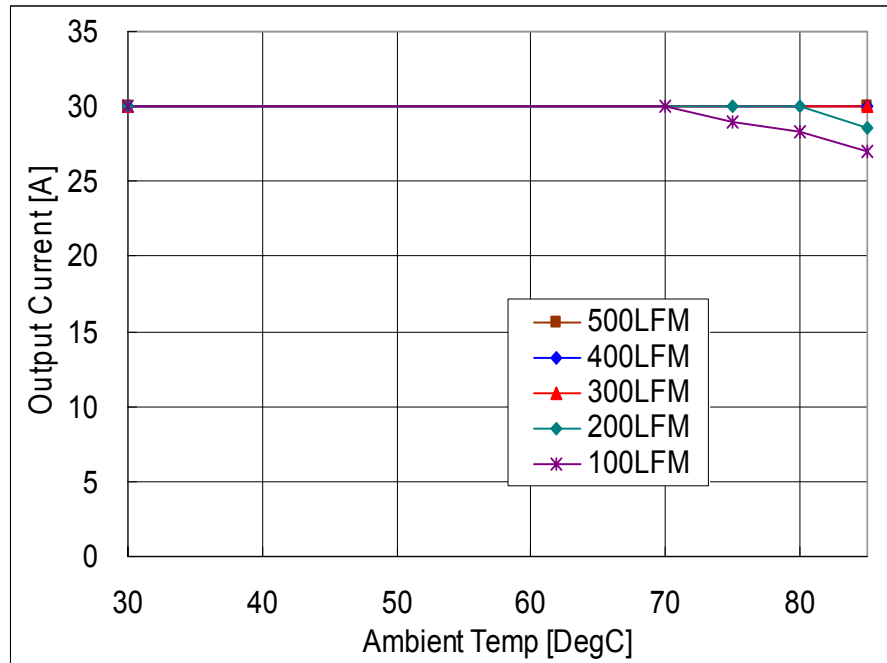

Fig.1.5V-1: Available load current vs. ambient temperature and airflow rates for Vin=48V. Maximum component temperature $\leq 125^{\circ}\text{C}$

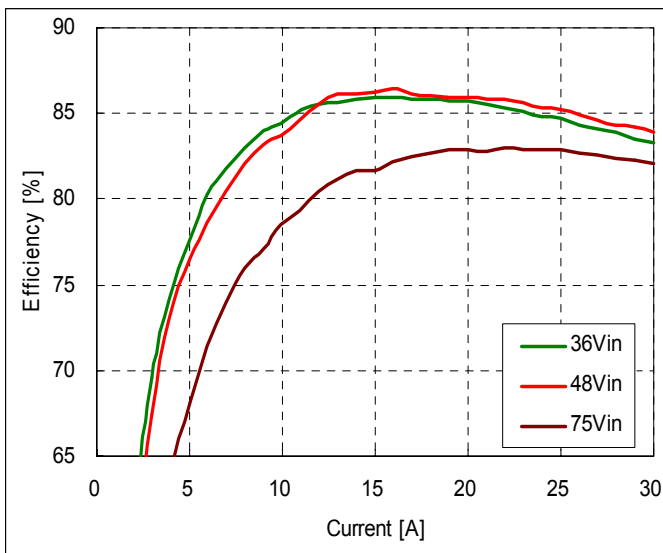

Fig.1.5V-2: Efficiency vs. load current and input voltage for converter mounted horizontally with airflow from pin 3 to pin 1 at a rate of 300LFM (1.5m/s) and Ta=25°C.

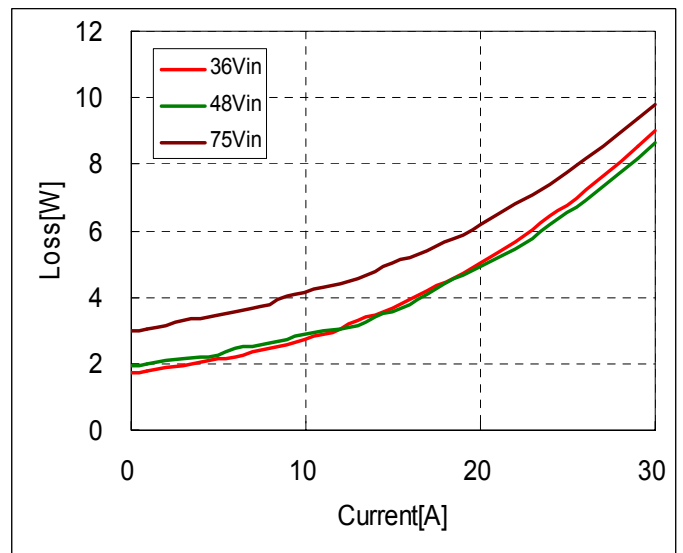

Fig.1.5V-3: Power dissipation vs. load current and input voltage for converter mounted horizontally with airflow from pin 3 to pin 1 at a rate of 300LFM (1.5m/s) and Ta=25°C.

FPER48Txyz30*A

36-75Vdc Input, 30A, 1.2-3.3Vdc Output

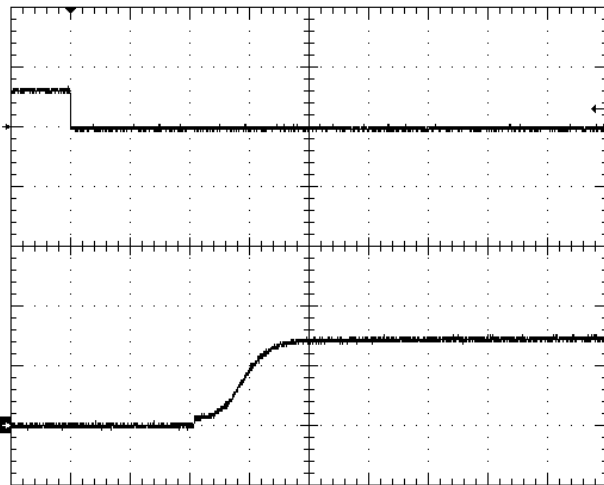

Fig.1.5V-4: Turn-on transient at full rated load current (resistive) with 10µF tantalum + 1µF ceramic capacitor at Vin=48V, triggered via ON/OFF pin. Top trace: ON/OFF signal (5V/div). Bottom trace: output voltage (1V/div). Time scale: 2ms/div

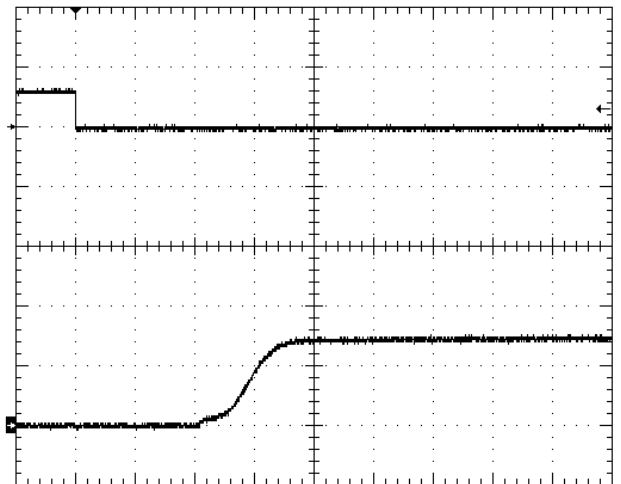

Fig.1.5V-5: Turn-on transient at full rated load current (resistive) plus 20,000µF at Vin=48V, triggered via ON/OFF pin. Top trace: ON/OFF signal (5V/div). Bottom trace: output voltage (1V/div). Time scale: 2ms/div

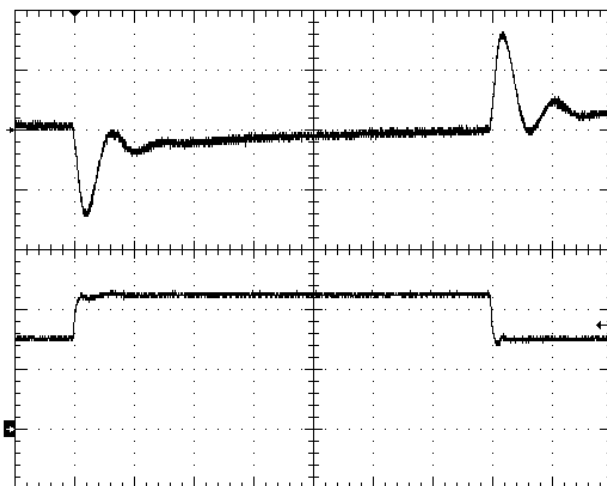

Fig.1.5V-6: Output voltage response to load current step-change (15⇌22.5A) at Vin=48V. Top trace: Output voltage (100mV/div). Bottom trace: load current (10A/div). Current slew rate: 5A/µs. Co=470µF os-con + 10µF tantalum + 1µF ceramic. Time scale: 100µs/div

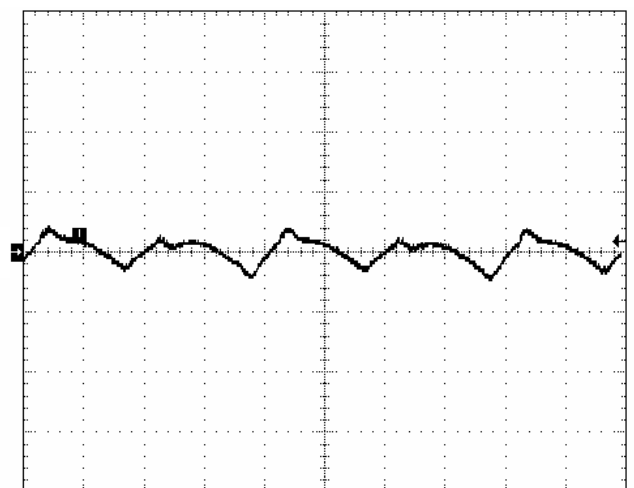

Fig.1.5V-7: Output voltage ripple (50mV/div) at full rated load current into a resistive load with Co=10µF tantalum + 1µF ceramic and Vin=48V. Time scale: 1µs/div

FPER48Txyz30*A

36-75Vdc Input, 30A, 1.2-3.3Vdc Output

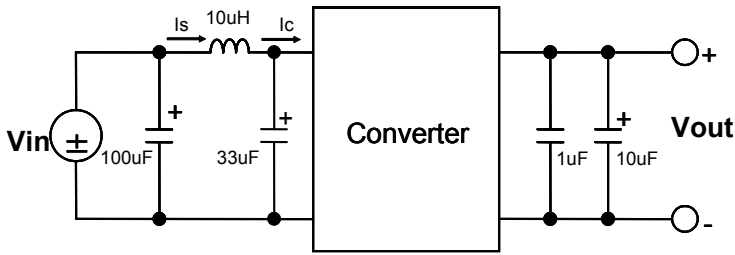

Fig.1.5V-8: Test Set-up for measuring input reflected ripple current.

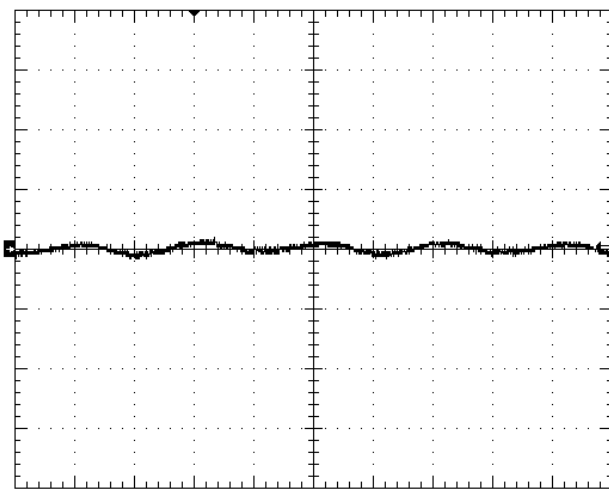

Fig.1.5V-9: Input reflected ripple current, I_s (5mA/div), measured through 10µH at the source at full rated load current and $V_{in}=48V$. Time scale: 1µs/div.

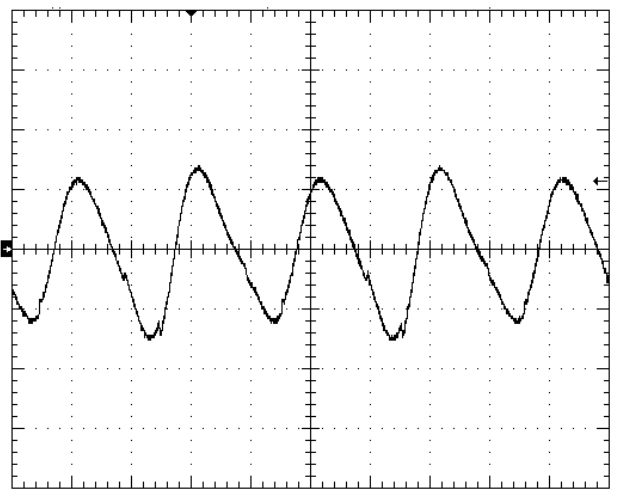

Fig.1.5V-10: Input reflected ripple current, I_c (100mA/div), measured through 10µH at the source at full rated load current and $V_{in}=48V$. Time scale: 1µs/div.

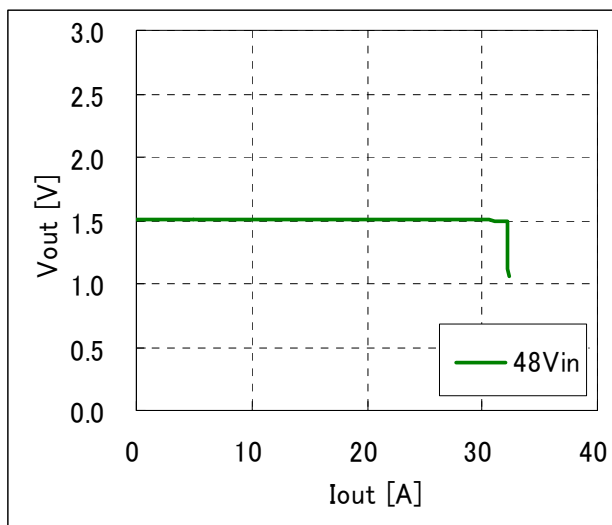

Fig.1.5V-11: Output voltage vs. load current showing current limit point and converter shutdown point. ($V_{in} = 48V$)

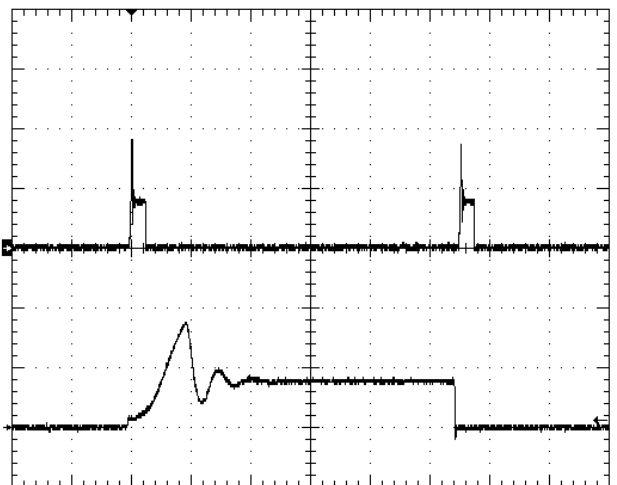

Fig.1.5V-12: Load current (top trace, 50A/div, 40ms/div) into a 10mΩ short circuit during restart, at $V_{in} = 48V$. Bottom trace (50A/div, 2ms/div) is an expansion of the top trace.

FPER48Txyz30*A

36-75Vdc Input, 30A, 1.2-3.3Vdc Output

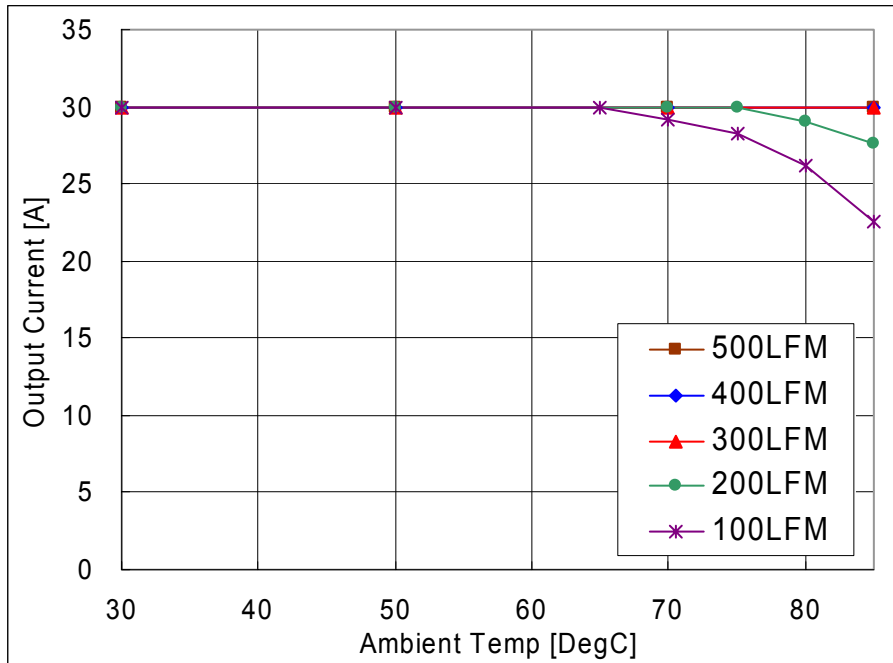

Fig.1.2V-1: Available load current vs. ambient temperature and airflow rates for Vin=48V. Maximum component temperature $\leq 125^{\circ}\text{C}$

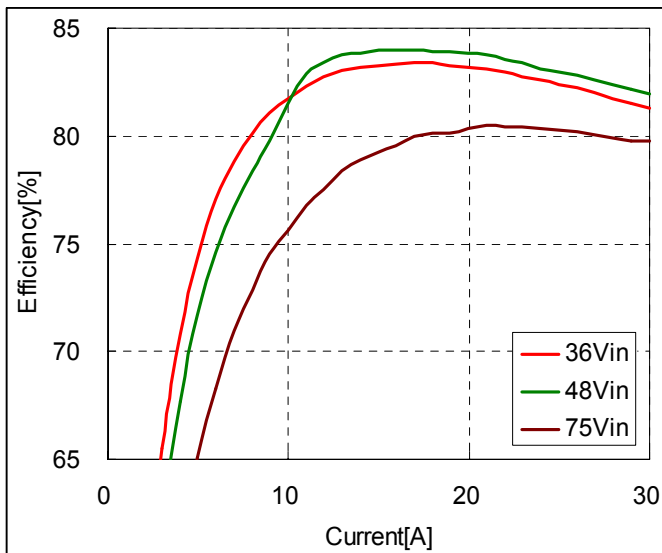

Fig.1.2V-2: Efficiency vs. load current and input voltage for converter mounted horizontally with airflow from pin 3 to pin 1 at a rate of 300LFM (1.5m/s) and Ta=25°C.

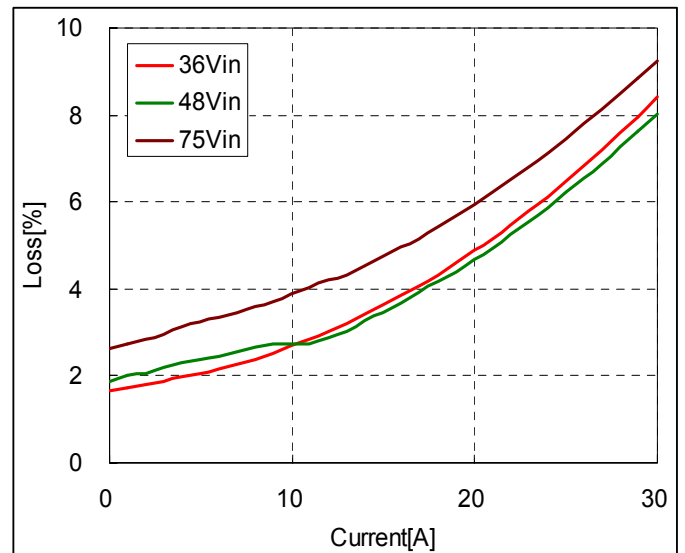

Fig.1.2V-3: Power dissipation vs. load current and input voltage for converter mounted horizontally with airflow from pin 3 to pin 1 at a rate of 300LFM (1.5m/s) and Ta=25°C.

FPER48Txyz30*A

36-75Vdc Input, 30A, 1.2-3.3Vdc Output

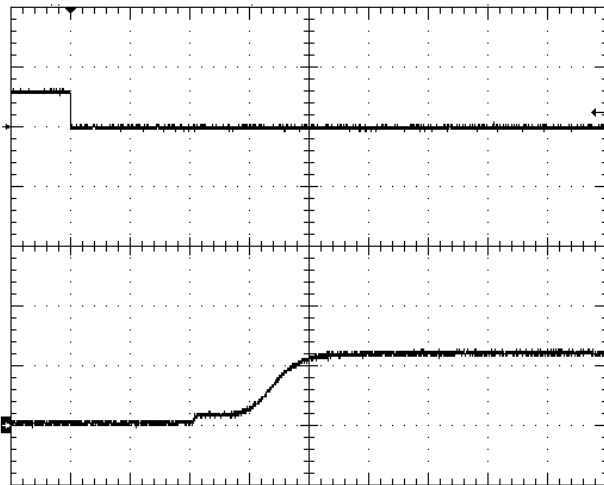

Fig.1.2V-4: Turn-on transient at full rated load current (resistive) with 10µF tantalum + 1µF ceramic capacitor at Vin=48V, triggered via ON/OFF pin. Top trace: ON/OFF signal (5V/div). Bottom trace: output voltage (1V/div). Time scale: 2ms/div

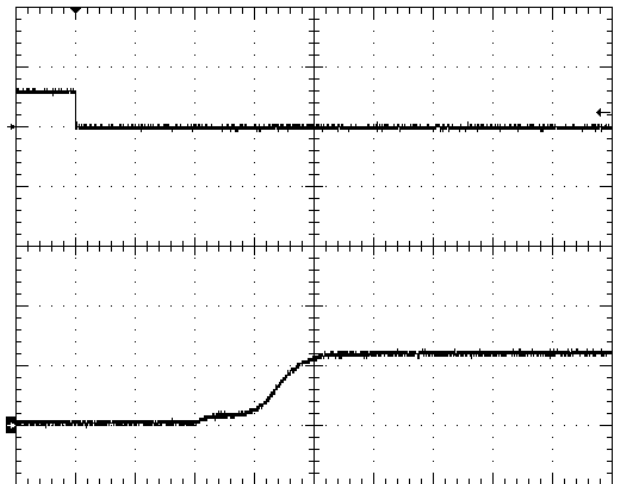

Fig.1.2V-5: Turn-on transient at full rated load current (resistive) plus 20,000µF at Vin=48V, triggered via ON/OFF pin. Top trace: ON/OFF signal (5V/div). Bottom trace: output voltage (1V/div). Time scale: 2ms/div

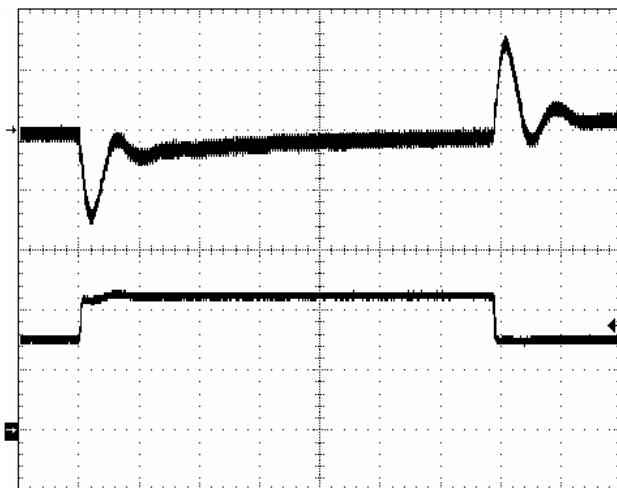

Fig.1.2V-6: Output voltage response to load current step-change (15⇌22.5A) at Vin=48V. Top trace: Output voltage (100mV/div). Bottom trace: load current (10A/div). Current slew rate: 5A/µs. Co=470µF os-con + 10µF tantalum + 1µF ceramic. Time scale: 100µs/div

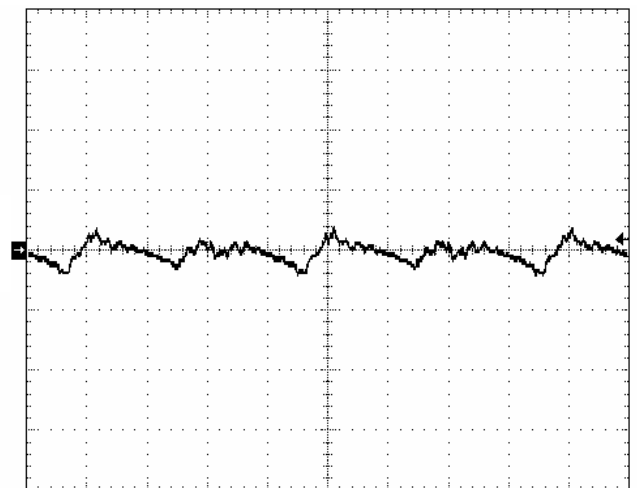

Fig.1.2V-7: Output voltage ripple (50mV/div) at full rated load current into a resistive load with Co=10µF tantalum + 1µF ceramic and Vin=48V. Time scale: 1µs/div

FPER48Txyz30*A

36-75Vdc Input, 30A, 1.2-3.3Vdc Output

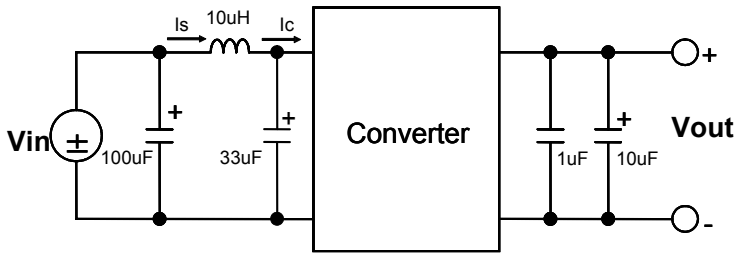

Fig.1.2V-8: Test Set-up for measuring input reflected ripple current.

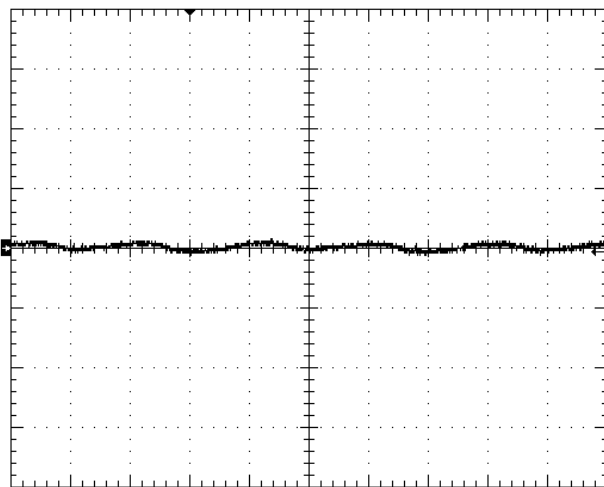

Fig.1.2V-9: Input reflected ripple current, I_s (5mA/div), measured through 10 μ H at the source at full rated load current and $V_{in}=48V$. Time scale: 1 μ s/div.

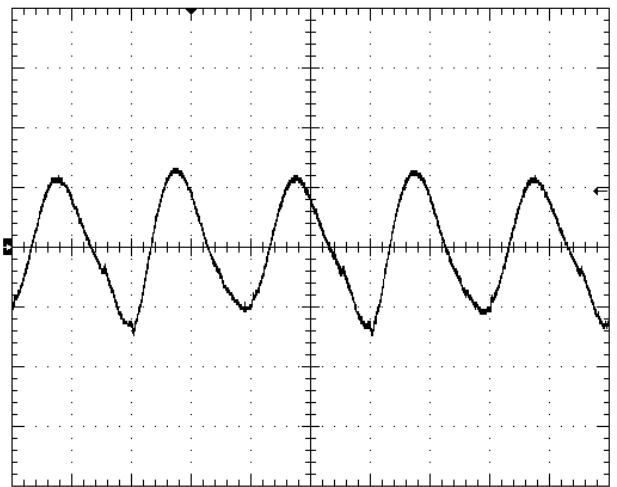

Fig.1.2V-10: Input reflected ripple current, I_c (100mA/div), measured through 10 μ H at the source at full rated load current and $V_{in}=48V$. Time scale: 1 μ s/div.

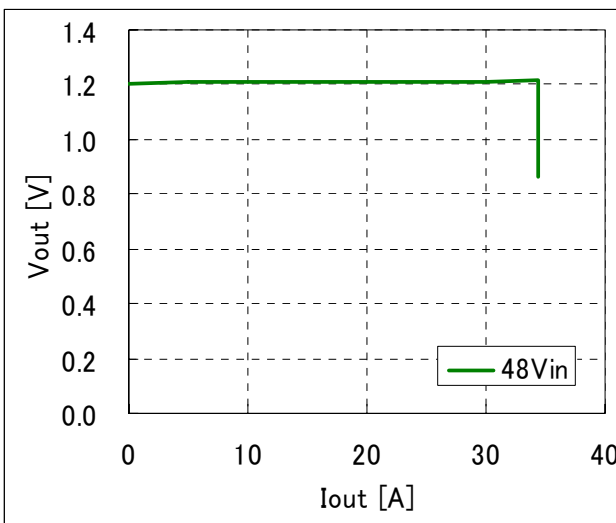

Fig.1.2V-11: Output voltage vs. load current showing current limit point and converter shutdown point. ($V_{in} = 48V$)

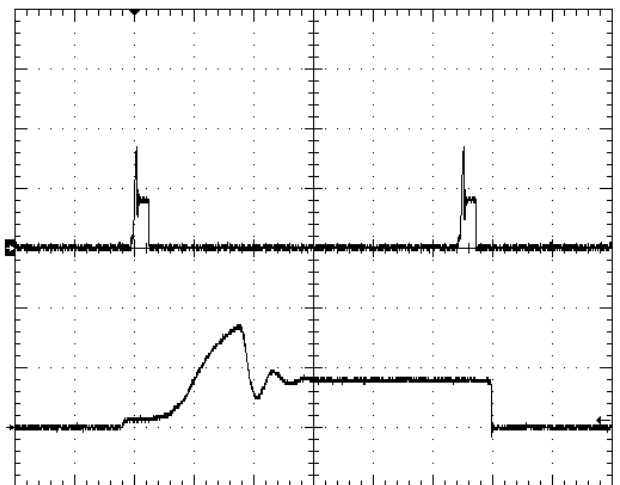
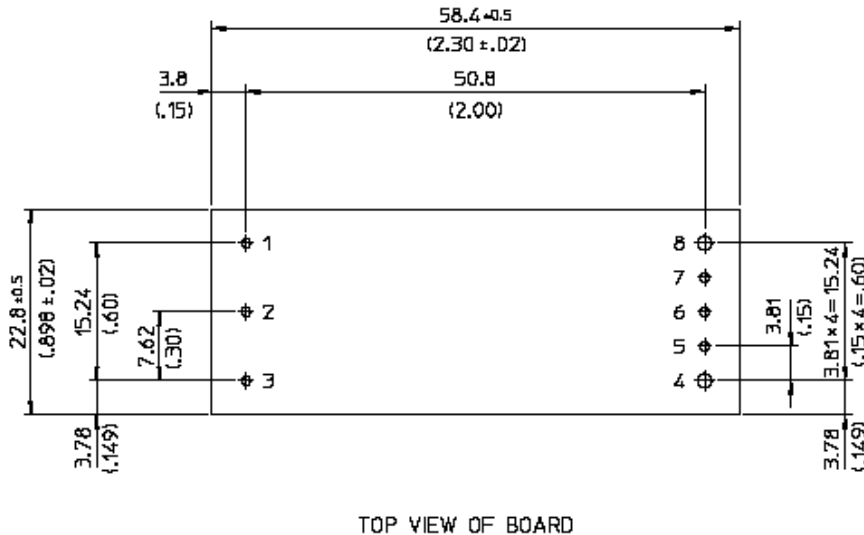

Fig.1.2V-12: Load current (top trace, 50A/div, 20ms/div) into a 10m Ω short circuit during restart, at $V_{in} = 48V$. Bottom trace (50A/div, 5ms/div) is an expansion of the top trace.

FPER48Txyz30*A

36-75Vdc Input, 30A, 1.2-3.3Vdc Output

Mechanical Drawing



Pin Connections	
Pin #	Function
1	Vin (+)
2	ON/OFF
3	Vin (-)
4	Vout (-)
5	SENSE (-)
6	TRIM
7	SENSE (+)
8	Vout (+)

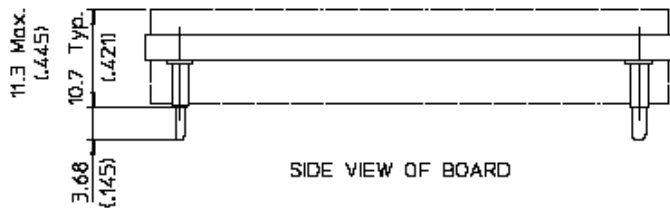

Notes

- All dimensions are in millimeters (inches)
- Unless otherwise specified, tolerances are +/- 0.25mm
- Pins 1-3 and 5-7 are $\Phi 1.02$ (0.040") with $\Phi 1.80$ (0.071") shoulder
Recommended TH dia. is $\phi 1.40$ (0.055")
- Pins 4 and 8 are $\Phi 1.58$ (0.062") with $\Phi 2.40$ (0.094") shoulder
Recommended TH dia. is $\phi 2.00$ (0.079")
- Pin Material: Copper
- Pin Finish: Tin over Nickel
- Converter Weight: 0.81oz (23.0g) typical

Part Number System

Product Series	Size	Regulation	Input Voltage	Mounting Scheme	Output Voltage	Rated Current	ON/OFF Logic	Pin Shape
FP	E	R	48	T	xyz	30	*	A
Series Name	Eighth Brick	Regulated	36V – 75V	Through Hole	1R2⇒1.2V 1R5⇒1.5V 1R8⇒1.8V 2R5⇒2.5V 3R3⇒3.3V	30A	N: Negative P: Positive	Standard

Cautions

NUCLEAR AND MEDICAL APPLICATIONS: FDK Corporation products are not authorized for use as critical components in life support systems, equipment used in hazardous environments, or nuclear control systems without the written consent of FDK Corporation.

SPECIFICATION CHANGES AND REVISIONS: Specifications are version-controlled, but are subject to change without notice.

Mouser Electronics

Authorized Distributor

Click to View Pricing, Inventory, Delivery & Lifecycle Information:

[Fujitsu:](#)

[FPER48T1R530NA](#) [FPER48T1R230PA](#) [FPER48T1R830PA](#) [FPER48T1R530PA](#) [FPER48T3R330PA](#)
[FPER48T2R530NA](#) [FPER48T1R230NA](#) [FPER48T3R330NA](#) [FPQR48T5R050PA](#) [FPER48T1R830NA](#)
[FPER48T2R530PA](#)

Компания «Life Electronics» занимается поставками электронных компонентов импортного и отечественного производства от производителей и со складов крупных дистрибьюторов Европы, Америки и Азии.

С конца 2013 года компания активно расширяет линейку поставок компонентов по направлению коаксиальный кабель, кварцевые генераторы и конденсаторы (керамические, пленочные, электролитические), за счёт заключения дистрибьюторских договоров

Мы предлагаем:

- Конкурентоспособные цены и скидки постоянным клиентам.
- Специальные условия для постоянных клиентов.
- Подбор аналогов.
- Поставку компонентов в любых объемах, удовлетворяющих вашим потребностям.
- Приемлемые сроки поставки, возможна ускоренная поставка.
- Доставку товара в любую точку России и стран СНГ.
- Комплексную поставку.
- Работу по проектам и поставку образцов.
- Формирование склада под заказчика.
- Сертификаты соответствия на поставляемую продукцию (по желанию клиента).
- Тестирование поставляемой продукции.
- Поставку компонентов, требующих военную и космическую приемку.
- Входной контроль качества.
- Наличие сертификата ISO.

В составе нашей компании организован Конструкторский отдел, призванный помогать разработчикам, и инженерам.

Конструкторский отдел помогает осуществить:

- Регистрацию проекта у производителя компонентов.
- Техническую поддержку проекта.
- Защиту от снятия компонента с производства.
- Оценку стоимости проекта по компонентам.
- Изготовление тестовой платы монтаж и пусконаладочные работы.



Тел: +7 (812) 336 43 04 (многоканальный)

Email: org@lifeelectronics.ru