

SMD ▪ PLCC

EAHE5630WE53

Preliminary



Features

- PLCC-2 Package
- Top view white LED
- High luminous flux output
- High current capability
- High Efficiency
- Wide viewing angle
- Pb-free
- RoHS compliant
- ANSI Binning

Description

The Everlight EAHE5630WE53 package has high efficacy, high CRI, low power consumption, wide viewing angle and a compact form factor. These features make this package an ideal LED for all lighting application.

Applications

- Decorative and Entertainment Lighting
- Light pipe application
- Indicator and backlight in office and family equipment
- General use

Mass Production List for CRI>80

Product	CRI Min. (1)	CCT(K)	Φ(lm) Min. (2)	Φ(lm) Typ. (2)	Φ(lm) Max. (2)
EAHE5630WE53	80	5700K	33	34	43

1. Tolerance of Color Rendering Index: ± 3
2. Tolerance of Luminous flux: $\pm 11\%$.

Device Selection Guide

Chip Materials	Emitted Color	Resin Color
InGaN	Cool White	Water Clear
	Neutral White	
	Warm White	

Absolute Maximum Ratings ($T_{\text{Soldering}}=25^{\circ}\text{C}$)

Parameter	Symbol	Rating	Unit
Forward Current	I_F	180	mA
Peak Forward Current (Duty 1/10 @10ms)	I_{FP}	300	mA
Power Dissipation	P_d	540	mW
Operating Temperature	T_{opr}	-40 ~ +85	$^{\circ}\text{C}$
Storage Temperature	T_{stg}	-40 ~ +100	$^{\circ}\text{C}$
Thermal Resistance (Junction / Soldering point)	$R_{th\ J-S}$	21	$^{\circ}\text{C/W}$
Junction Temperature	T_j	115	$^{\circ}\text{C}$
Soldering Temperature	T_{sol}	Reflow Soldering : 260 $^{\circ}\text{C}$ for 10 sec. Hand Soldering : 350 $^{\circ}\text{C}$ for 3 sec.	

Electro-Optical Characteristics ($T_{\text{Soldering}}=25^{\circ}\text{C}$)

Parameter	Symbol	Min.	Typ.	Max.	Unit	Condition
Luminous Flux ₍₁₎	Φ	33	-----	43	lm	$I_F=65\text{mA}$
Forward Voltage ₍₂₎	V_F	2.5	-----	3.0	V	$I_F=65\text{mA}$
Color Rendering Index ₍₃₎	Ra	80	-----	-----	-----	$I_F=65\text{mA}$
Viewing Angle	$2\theta_{1/2}$	-----	120	-----	deg	$I_F=65\text{mA}$

Notes:

1. Tolerance of Luminous flux: $\pm 11\%$.
2. Tolerance of Forward Voltage: $\pm 0.1\text{V}$.
3. Tolerance of Color Rendering Index: ± 3

Bin Range of Luminous Flux

Bin Code	Min.	Max.	Unit	Condition
T1	33	35	lm	I _F =65mA
T2	35	37		
T3	37	39		
T4	39	41		
T5	41	43		

Notes:
 Tolerance of Luminous flux: ±11%

Bin Range of Forward Voltage

Group	Bin Code	Min.	Max.	Unit	Condition
2530	32	2.5	2.6	V	I _F =65mA
	33	2.6	2.7		
	34	2.7	2.8		
	35	2.8	2.9		
	36	2.9	3.0		

Notes:
 Tolerance of Forward Voltage : ±0.1V.

Bin Code of Macadam 3 step

Step	CCT	Cx	Cy	a	b	theta
3	2700	0.4583	0.4104	0.00810	0.00420	49.70
	3000	0.4345	0.4033	0.00834	0.00408	50.22
	3500	0.4080	0.3919	0.00927	0.00414	51.00
	4000	0.3827	0.3803	0.00939	0.00402	54.80
	5000	0.3451	0.3559	0.00822	0.00354	64.12
	5700	0.3293	0.3423	0.00747	0.00321	66.51
	6500	0.3131	0.3290	0.00669	0.00285	64.57

The C.I.E. 1931 Chromaticity Diagram

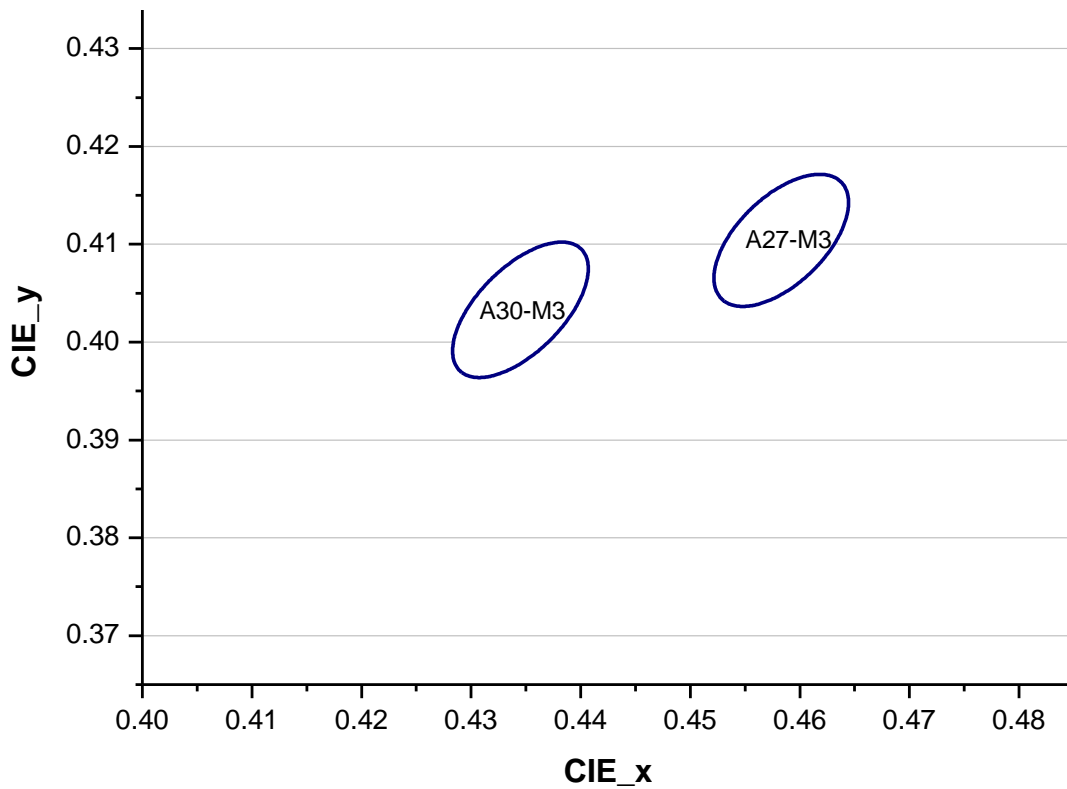

The C.I.E. 1931 Chromaticity Diagram

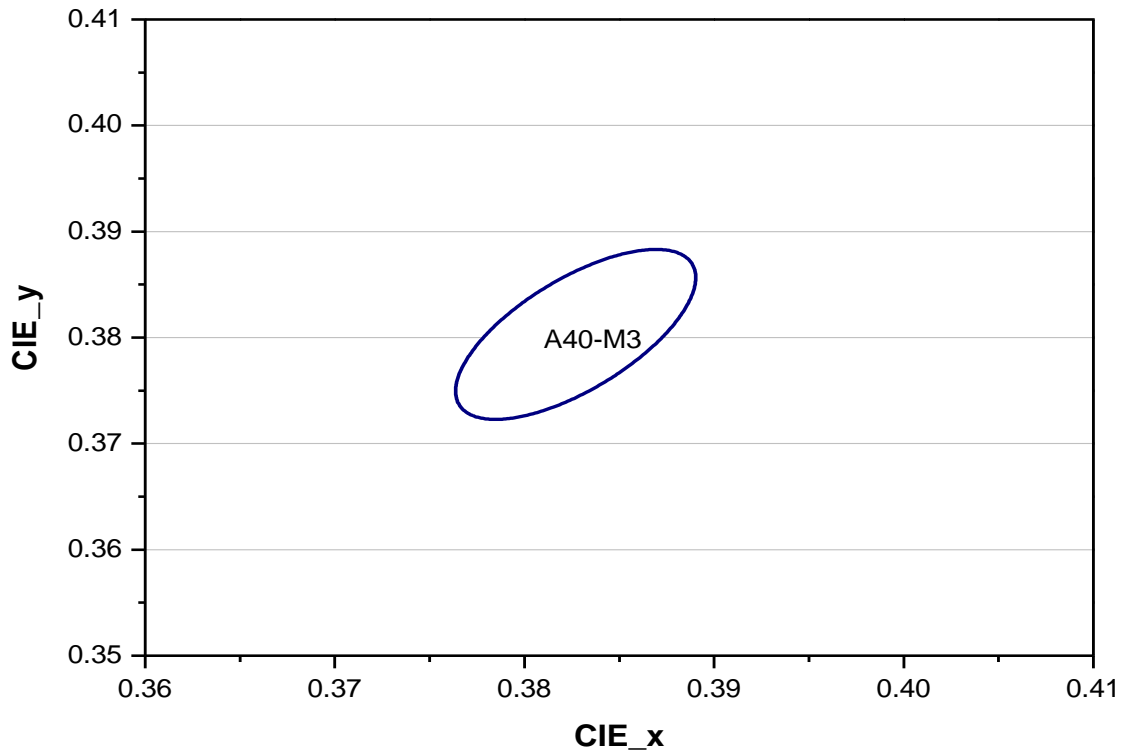

The C.I.E. 1931 Chromaticity Diagram

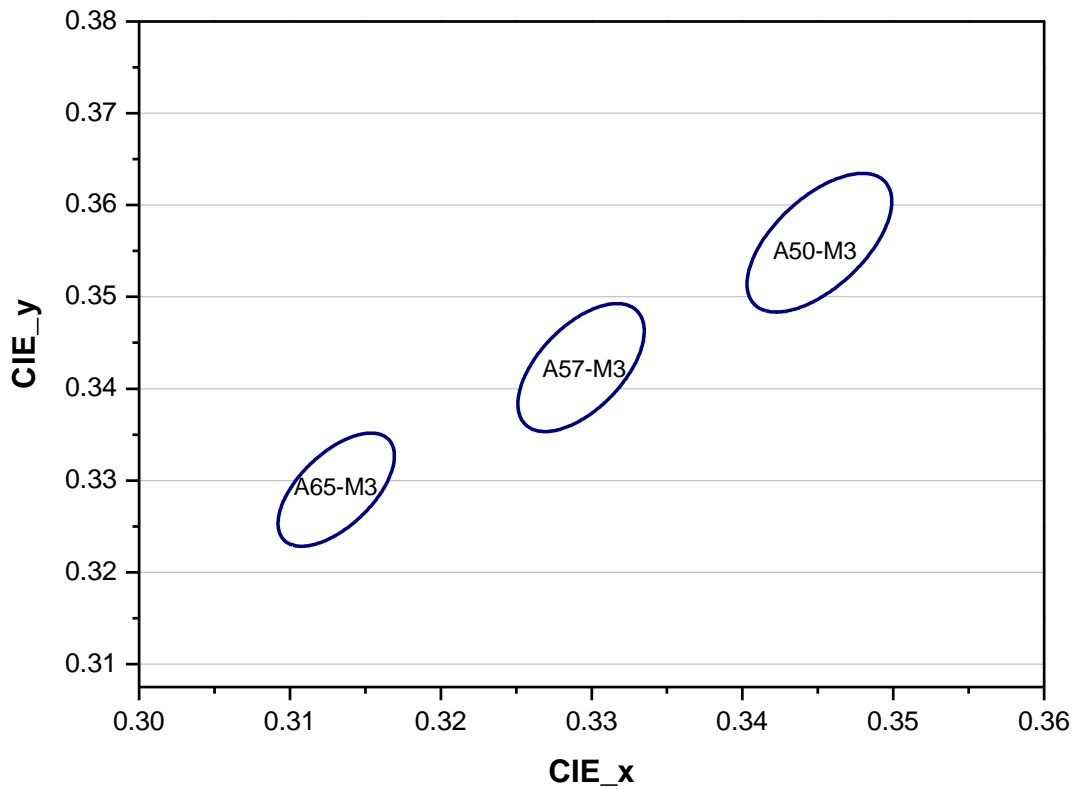

Note:

1. The value is based on driving current by 65mA.
2. Tolerance of Chromaticity Coordinates: ± 0.01 .

Spectrum Distribution

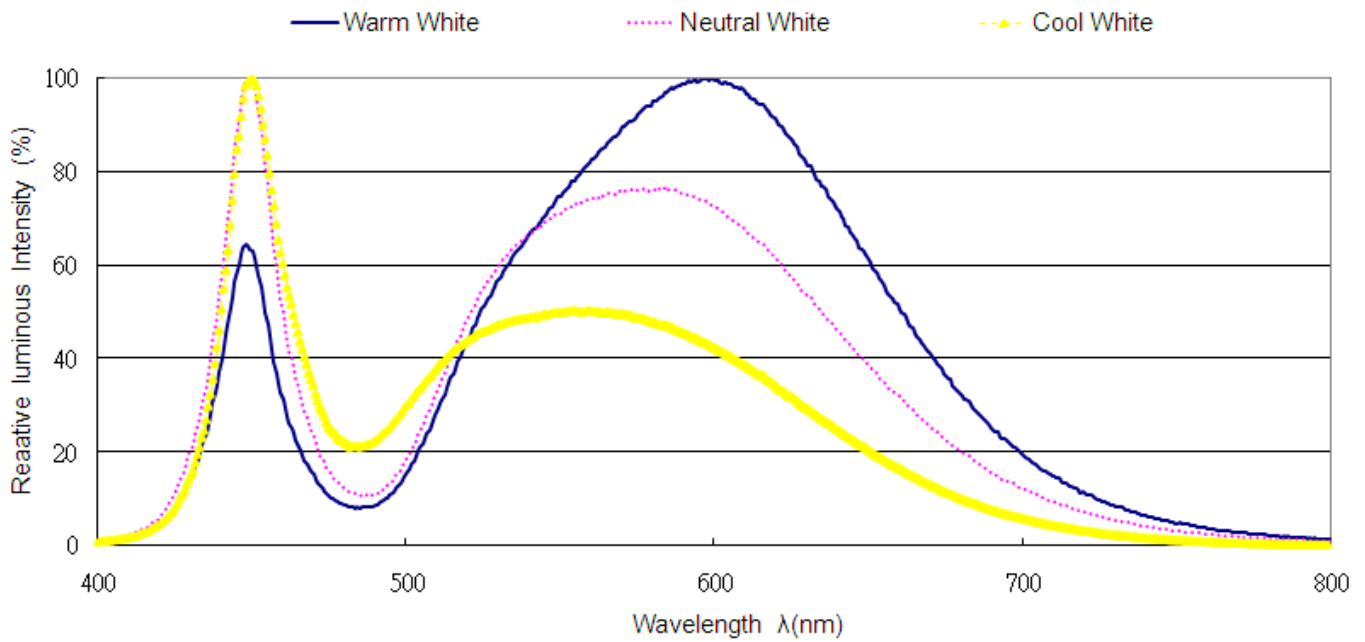

Typical Electro-Optical Characteristics Curves

Fig.1 – Forward Voltage Shift vs. Junction Temperature

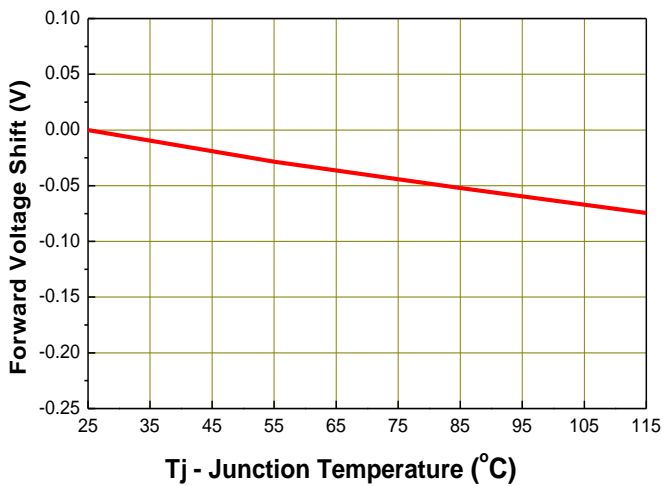
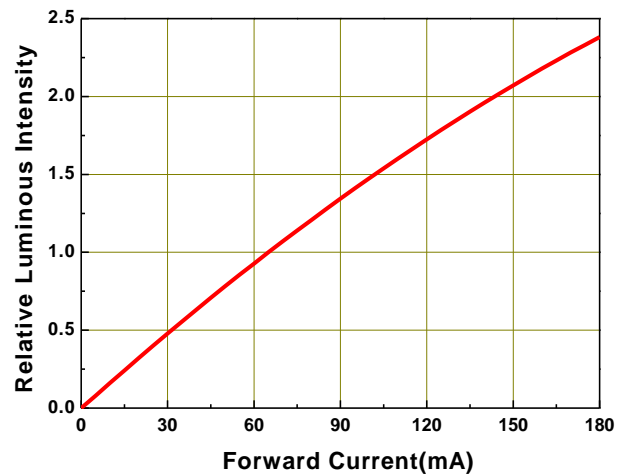

Fig.2 - Relative Luminous Intensity vs. Forward Current



Typical Electro-Optical Characteristics Curves

Fig.3 - Relative Luminous Intensity vs. Junction Temperature

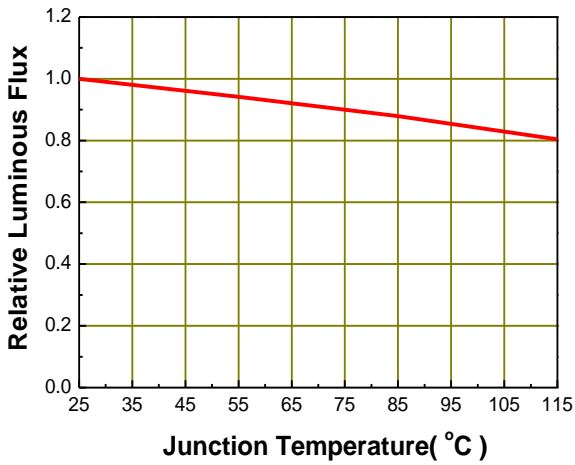

Fig.4 - Forward Current vs. Forward Voltage

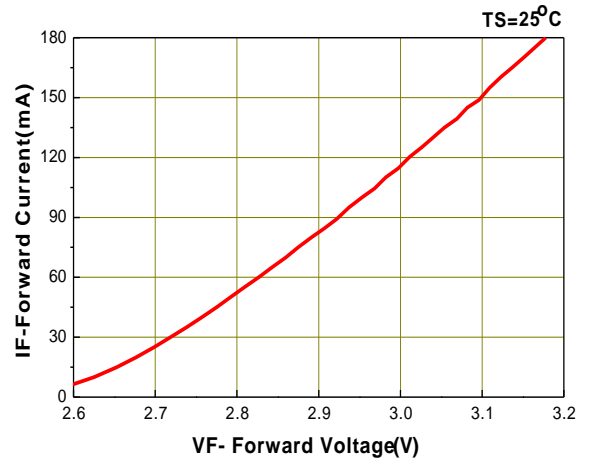

Fig.5 – Max. Driving Forward Current vs. Soldering Temperature

$R_{th\ j-s}=21\ ^\circ\text{C/W}$

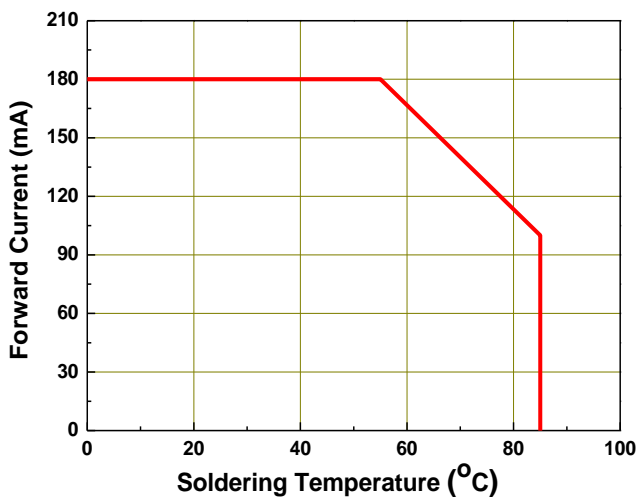
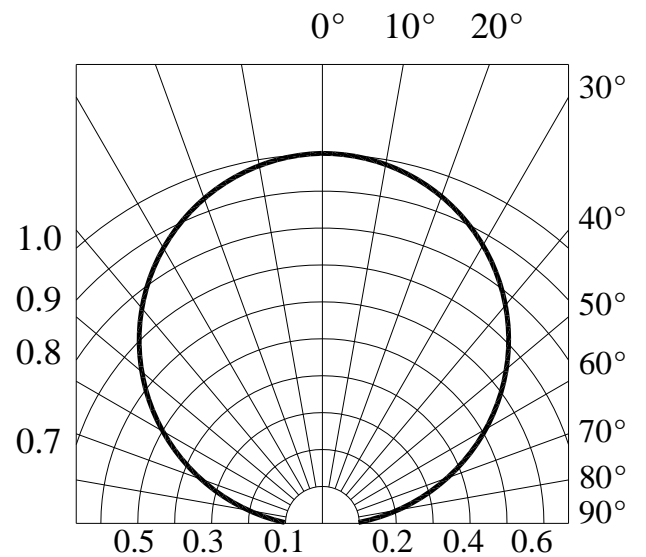
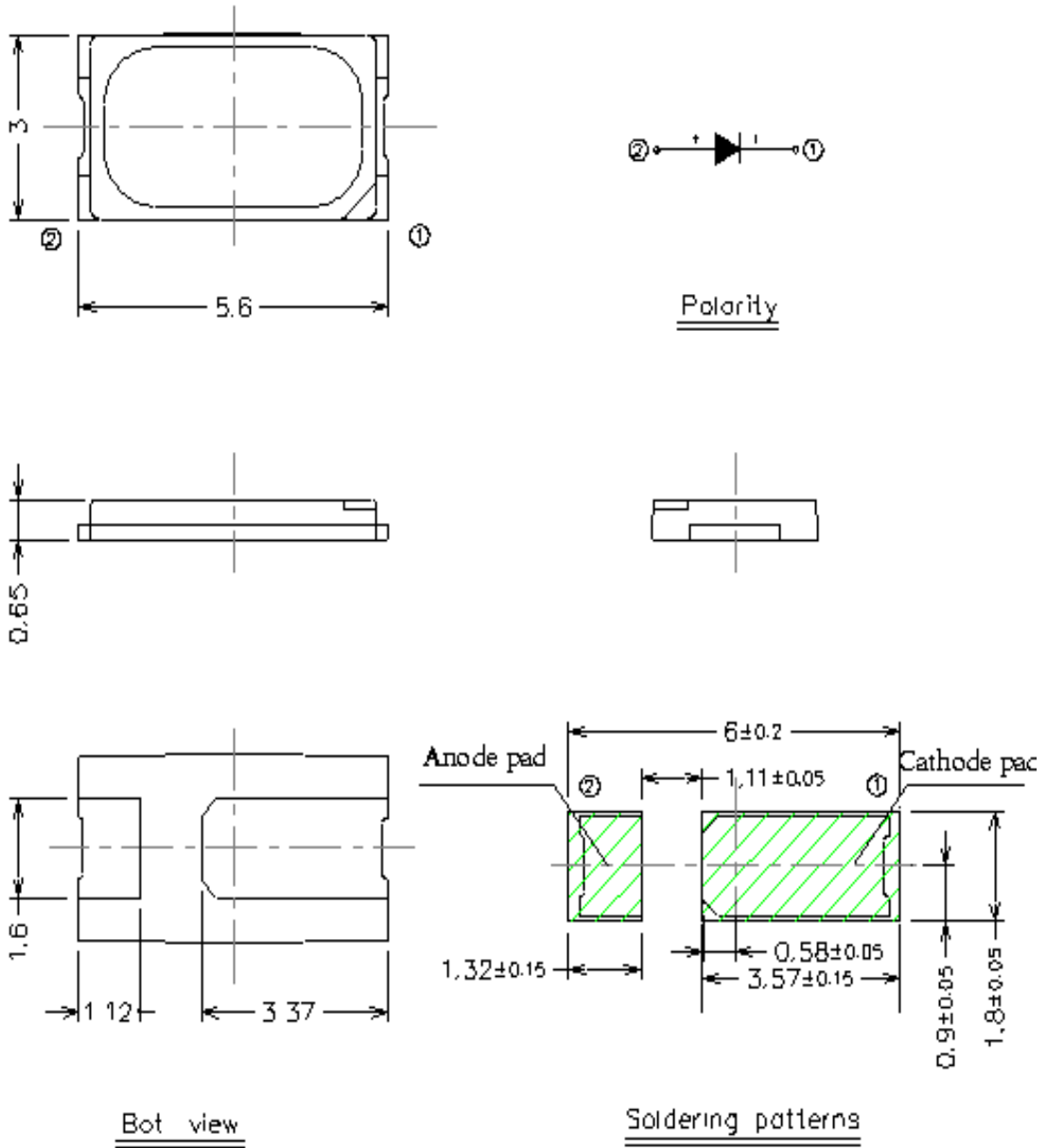

Fig.6 – Radiation Diagram



Package Dimension



Note:

Tolerance unless mentioned is ± 0.1 mm; Unit = mm

Moisture Resistant Packing Materials

Label Explanation

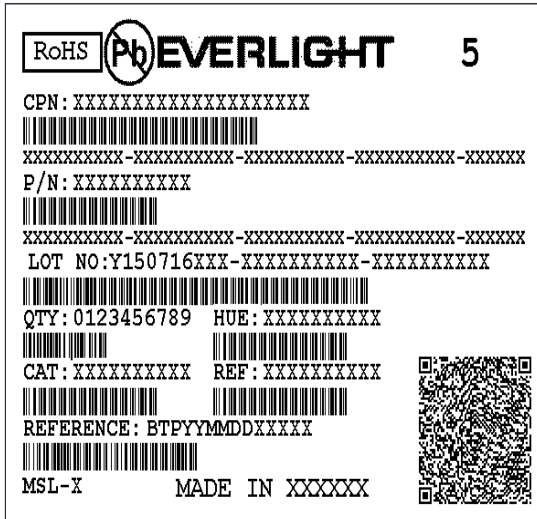

- CPN: Customer's Product Number
- P/N: Product Number
- QTY: Packing Quantity
- CAT: Luminous Intensity Rank
- HUE: Dom. Wavelength Rank
- REF: Forward Voltage Rank
- LOT No: Lot Number

Reel Dimensions

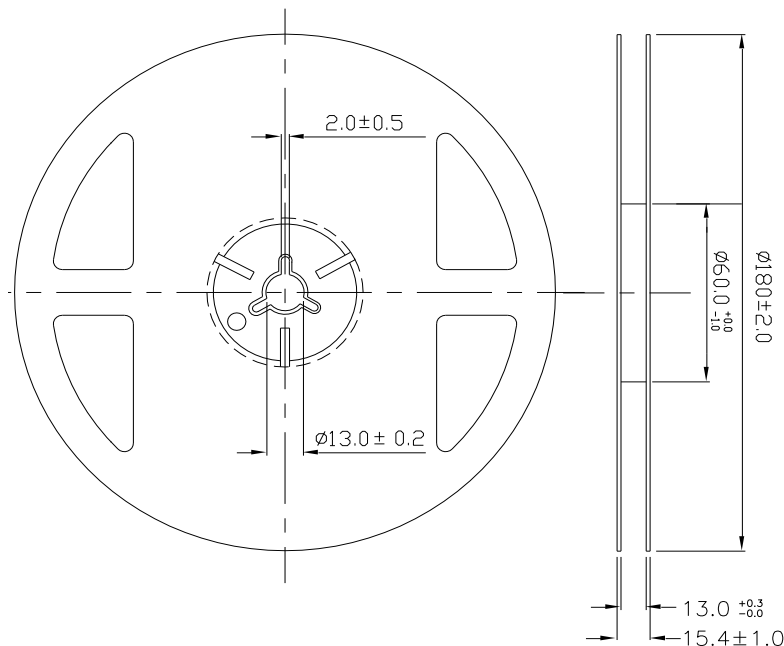

Note:
Tolerances unless mentioned ± 0.1 mm. Unit = mm

Carrier Tape Dimensions: Loaded Quantity 2000 pcs. Per Reel

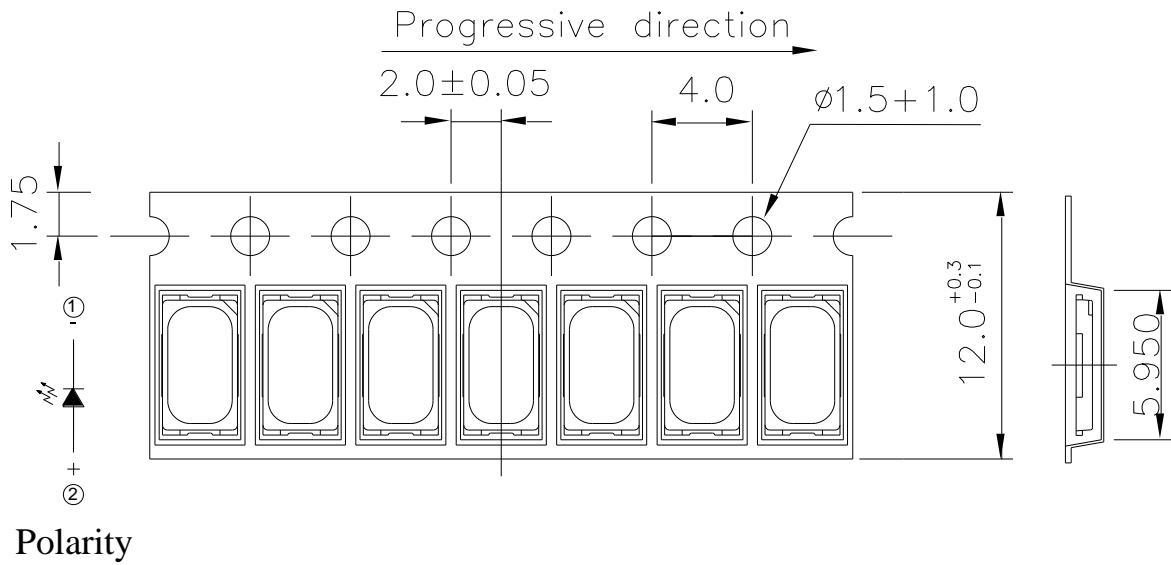

Note:

Tolerance unless mentioned is ± 0.1 mm; Unit = mm

Moisture Resistant Packing Process

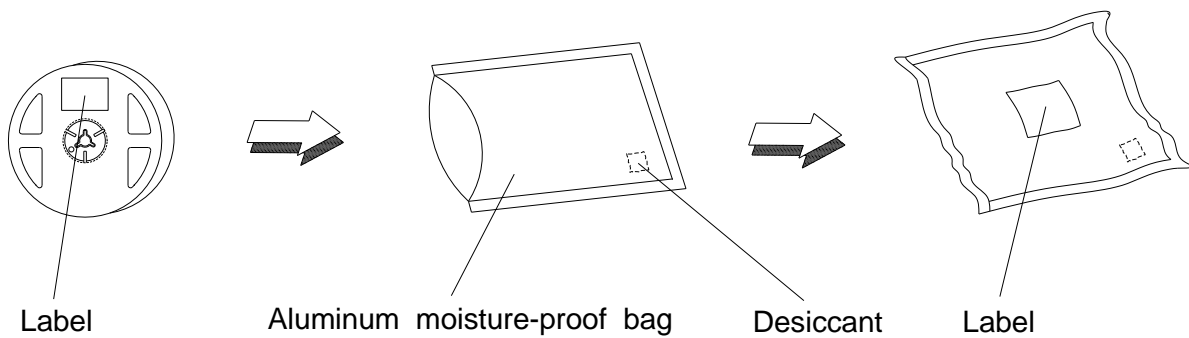

Reliability Test Items and Conditions

The reliability of products shall be satisfied with items listed below.
Confidence level : 90%
LTPD : 10%

No.	Items	Test Condition	Test Hours/Cycles	Sample Size	Ac/Re
1	Reflow Soldering	Temp. : 260°C/10sec.	6 Min.	22 PCS.	0/1
2	Thermal Shock	H : +100°C 20min ∫ 10 sec L : -10°C 20min	200 Cycles	22 PCS.	0/1
3	Temperature Cycle	H : +100°C 30min ∫ 5 min L : -40°C 30min	200 Cycles	22 PCS.	0/1
4	High Temperature/Humidity Storage	Ta=85°C,85%RH	1000 Hrs.	22 PCS.	0/1
5	High Temperature/Humidity Operation	Ta=85°C,85%RH, I _F = 100 mA	1000 Hrs.	22 PCS.	0/1
6	Low Temperature Storage	Ta=-40°C	1000 Hrs.	22 PCS.	0/1
7	High Temperature Storage	Ta=85°C	1000 Hrs.	22 PCS.	0/1
8	Low Temperature Operation Life	Ta=-40°C, I _F = 150 mA	1000 Hrs.	22 PCS.	0/1
9	High Temperature Operation/ Life#1	Ta=25°C, I _F = 150 mA	1000 Hrs.	22 PCS.	0/1
10	High Temperature Operation/ Life#2	Ta=55°C, I _F =150 mA	1000 Hrs.	22 PCS.	0/1
11	High Temperature Operation/ Life#3	Ta=85°C, I _F = 100 mA	1000 Hrs.	22 PCS.	0/1

Precautions for Use

1. Over-current-proof

Customer must apply resistors for protection; otherwise slight voltage shift will cause big current change (Burn out will happen).

2. Storage

2.1 Do not open moisture proof bag before the products are ready to use.

2.2 Before opening the package: The LEDs should be kept at 30°C or less and 90%RH or less.

2.3 After opening the package: The LED's floor life is 168 Hrs under 30°C or less and 60% RH or less. If unused LEDs remain, it should be stored in moisture proof packages.

2.4 If the moisture absorbent material (silica gel) has faded away or the LEDs have exceeded the storage time, baking treatment should be performed using the following conditions.

Baking treatment: 60±5°C for 24 hours.

3. Soldering Condition

3.1 Pb-free solder temperature profile

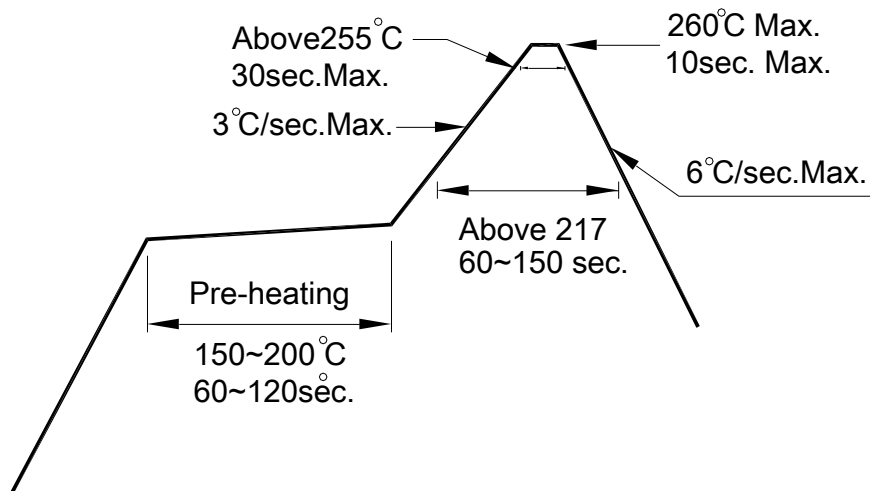

3.2 Reflow soldering should not be done more than two times.

3.3 When soldering, do not put stress on the LEDs during heating.

3.4 After soldering, do not warp the circuit board.

4. Soldering Iron

Each terminal is to go to the tip of soldering iron temperature less than 350°C for 3 seconds within once in less than the soldering iron capacity 25W. Leave two seconds and more intervals, and do soldering of each terminal. Be careful because the damage of the product is often started at the time of the hand solder.

5. Repairing

Repair should not be done after the LEDs have been soldered. When repairing is unavoidable, a double-head soldering iron should be used (as below figure). It should be confirmed beforehand whether the characteristics of the LEDs will or will not be damaged by repairing.

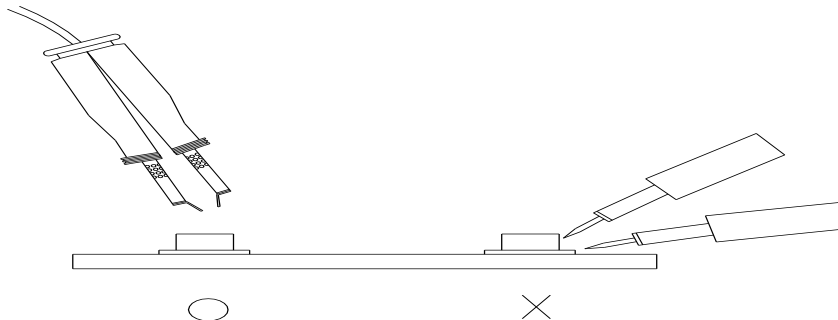

Компания «Life Electronics» занимается поставками электронных компонентов импортного и отечественного производства от производителей и со складов крупных дистрибьюторов Европы, Америки и Азии.

С конца 2013 года компания активно расширяет линейку поставок компонентов по направлению коаксиальный кабель, кварцевые генераторы и конденсаторы (керамические, пленочные, электролитические), за счёт заключения дистрибьюторских договоров

Мы предлагаем:

- Конкурентоспособные цены и скидки постоянным клиентам.
- Специальные условия для постоянных клиентов.
- Подбор аналогов.
- Поставку компонентов в любых объемах, удовлетворяющих вашим потребностям.
- Приемлемые сроки поставки, возможна ускоренная поставка.
- Доставку товара в любую точку России и стран СНГ.
- Комплексную поставку.
- Работу по проектам и поставку образцов.
- Формирование склада под заказчика.
- Сертификаты соответствия на поставляемую продукцию (по желанию клиента).
- Тестирование поставляемой продукции.
- Поставку компонентов, требующих военную и космическую приемку.
- Входной контроль качества.
- Наличие сертификата ISO.

В составе нашей компании организован Конструкторский отдел, призванный помогать разработчикам, и инженерам.

Конструкторский отдел помогает осуществить:

- Регистрацию проекта у производителя компонентов.
- Техническую поддержку проекта.
- Защиту от снятия компонента с производства.
- Оценку стоимости проекта по компонентам.
- Изготовление тестовой платы монтаж и пусконаладочные работы.



Тел: +7 (812) 336 43 04 (многоканальный)

Email: org@lifeelectronics.ru