

V-Series

Contura XIV Switches

The V-Series Contura XIV snap-in rocker switches offer countless unique options including choices for ratings, circuits, colors, illuminations and legends. These single or double pole switches feature removable actuators in a choice of actuator styles and colors, and can be illuminated with either square or bar shaped lenses. Actuators may be purchased and stocked separately. An optional plug-in terminal connector enables pre-wiring of harnesses.

The Contura switches, with sealed option, are certified to IP66 and IP68 for front panel components, signifying complete protection against dust, prolonged spray, submersion under pressure and are recognized to UL1500 - Ignition Protection for Marine Products. These switches are vibration, shock, thermoshock, moisture and salt spray resistant with temperature ratings ranging from -40°C to 85°C.

Resources:

[Download 3D Files](#)

[IGS >](#) [STP >](#)

[Watch Product Video](#)



Product Highlights:

- ♦ Recessed ridges and center groove define the boundary between top and bottom switch functions
- ♦ Countless options for ratings, circuits, colors, illuminations and legends
- ♦ Certified to IP66 and IP68 for front panel components
- ♦ Vibration, shock, thermoshock, moisture and salt spray resistant
- ♦ Temperature ratings from -40°C to 85°C.

Typical Applications:

- ♦ On/Off Highway Equipment
- ♦ Marine
- ♦ Military Armored Vehicles
- ♦ Mining Machinery and Equipment
- ♦ Any application requiring environmental protection



Carling Technologies™

Innovative Designs. Powerful Solutions.

Carling Technologies, Inc.
60 Johnson Avenue, Plainville, CT 06062
Email: sales@carlingtech.com
Application Support: team2@carlingtech.com
Phone: (860) 793-9281 • Fax: (860) 793-9231
www.carlingtech.com

V-Series Switch

DESIGN FEATURES

INTERCHANGEABLE ACTUATORS

Panel redesign is a snap with our wide range of rocker styles. Achieve maximum design variety with minimum inventory. Simply swap rockers to create an entirely new look for your panel.

DUAL SEAL PROTECTION

Seals out water, dust, debris, and enables switch certification to IP66/IP68 for front panel components.

CLEAN CONNECTIONS

Options for both eight and ten terminal base styles with AMP & Packard compatible connectors affords myriad circuit options while providing ease of assembly.

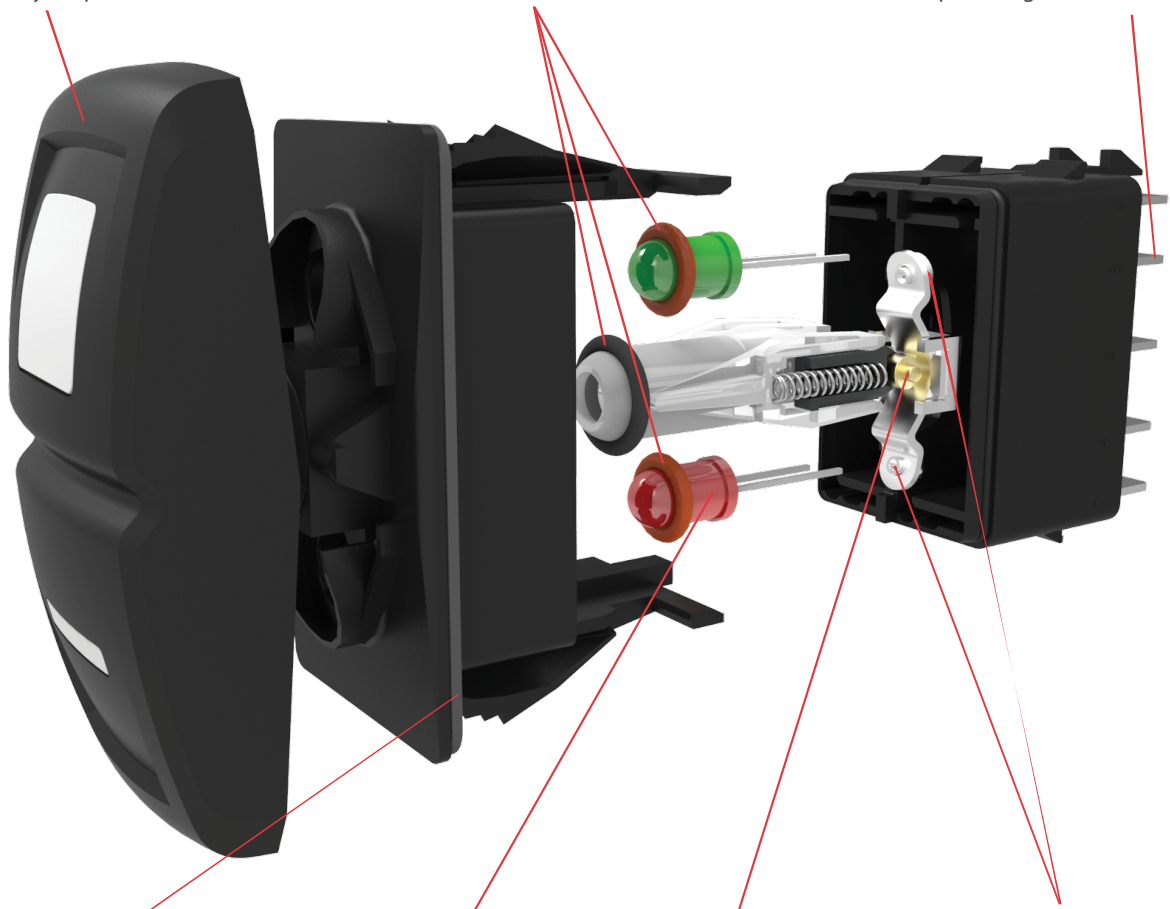

OPTIONAL PANEL SEAL

Prevents water/dust ingress behind panel.

MULTIPLE LIGHTING OPTIONS

In addition to Incandescent lamps, our LED illumination is offered in a wide array of light intensities, colors, as well as dual level, tri-color, and flashing options.

BRASS ROLLER PIN

Robust mechanism eliminates the need for lubricants. Enables switch to withstand -40°C to +85°C temperatures.

SILVER PLATED BUTT CONTACT MECHANISM

Providing 50k to 100k electrical cycles and a variety of different electrical ratings.

Electrical

Contact Rating	.4VA @ 24VDC (MAX) resistive 15 amps, 125VAC 10 amps, 250VAC 1/2 HP 125-250VAC 20 amps, 4-14VDC 15 amps, 15-28VDC 10A, 14VT 6A, 125VAC L
Dielectric Strength	1500 Volts RMS
Insulation Resistance	50 Megohms
Initial Contact Resistance	10 milliohms max. @ 4VDC
Life	50,000- 100,000 cycles circuit dependent
Contacts	Silver alloy, silver tin-oxide, fine silver
Terminals	Brass or copper/silver plate 1/4" (6.3mm) Quick Connect terminations standard. Solder lug, Wire Lead

Mechanical

Endurance	150,000 cycles minimum circuit dependent
-----------	---

Physical

Lighted	Incandescent - rated 10,000 hours Neon - rated 25,000 hours LED - rated 100,000 hours 1/2 life (LED is internally ballasted for voltages to 24VDC)
Seals	Internal Optional external gasket panel seal
Base	Polyester blend rated to 125°C with a UL flammability rating of 94V0.
Contura II,III,IV,V, VI, VII Actuator	Hard Surface: Basic actuator structure molded of thermoplastic polycarbonate with a hard Nylon 66 thermoplastic surface overlay. Soft Surface: Basic actuator structure molded of thermoplastic polycarbonate with an elastomer overlay.
Contura X,XI,XII Actuator,VP Lens	Nylon 66 Reinforced rated to 105°C Polycarbonate rated at 100°C
Contura XIV	Polycarbonate lens/subrocker with ABS shell

Actuator Travel (Angular Displacement)

2 position	18°
3 positions	9° from center

Mounting Specifications

Panel Thickness Range	
Gaskets Acceptable Panel Thickness	
0	.030 to .250 (.76mm to 6.35mm)
1	.030 to .109 & .147 to .157 (.76 to 2.77mm & 3.73 to 3.98mm)
Recommended: No gasket with panel thickness of .032, .062, .093, .125, .187 or .250	

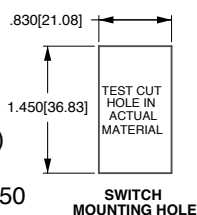

Environmental

Sealing	Sealed version: IP68, in accordance with IEC 60529, BS 5490, DIN 40050 & NFC 20 010. This rating applies to front panel components of the actual switch only, and signifies protection against dust and the prolonged effects of immersion under pressure. The standard test for immersion under pressure requires submersion under one meter of water for 30 min. The V-Series switch has exceeded these parameters, having been actuated and illuminated during submersion.
Corrosion	Mixed Flowing Gas (MFG) Class III 3 year accelerated exposure per ASTM B-827, B-845 Silver and gold contacts
Operating Temp. Vibration 1	-40°C to + 85°C Per Mil-Std 202F, Method 204D Test Condition A 0.06 DA or 10G's 10-500 Hz. Tested with VCH connector. Test criteria - No loss of circuit during test, pre and post test contact resistance.
Vibration 2	Resonance search 24-50 Hz 0.40 DA 50-2000 Hz ±10 G's peak Horizontal Axis 3-5 G's max. Random 24 Hz 0.06 PSD-Gsq/Hz 60 Hz 0.50 100 Hz 0.50 200 Hz 0.025 2000 Hz 0.025 No loss of circuit during test; <10µ seconds chatter.
Shock	Per Mil-Std 202F, Method 213B, Test Condition K @ 30G's. Tested with VCH connector. Test criteria - No loss of circuit during test, pre and post test contact resistance.
Salt Spray	Per Mil-Std 202F, Method 101D, Test Condition A, 96 Hrs. Sealed version only.
Dust	Per Mil-Std 810C, Method 510.2 Air Velocity 300 ±200 Feet/Min, Test Duration 16 Hrs.
Thermal Shock	Per Mil-Std 202F, Method 107F, Test Cond. A, -55°C to 85°C. Test criteria - pre and post test contact resistance
Moisture Resistance	Per Mil-Std 202F, Method 106F, Test Criteria - pre and post test contact resistance
Ignition Protection	All Contura switches with sealed construction meet the requirements of UL1500/ISO8846 for ignition protection, in addition to conformance with EC directive 94/25/EC for marine products.

Dimensional Specifications: in. [mm]

CONTURA XIV STYLE
SHOWN WITH LARGE LENS

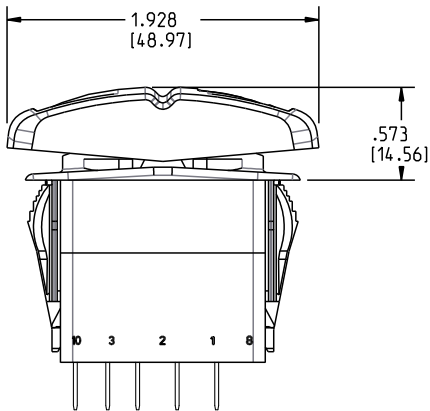
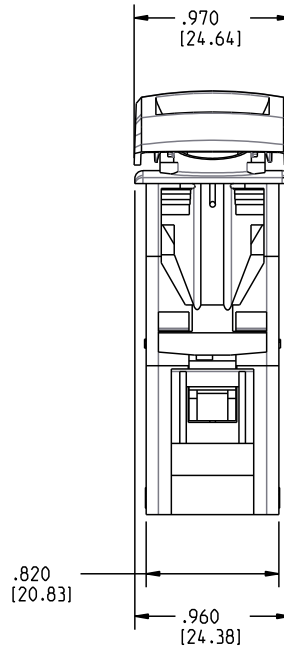
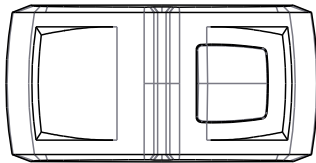

10 TERMINAL BASE
W/O BARRIERS

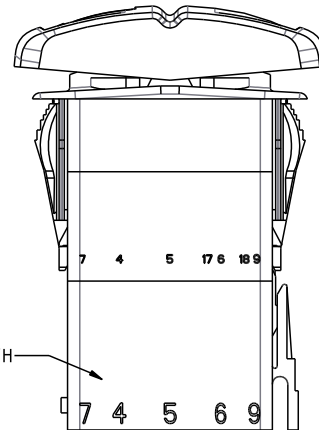

SWITCH SHOWN WITH
VC1 CONNECTOR
10 TERMINAL

CIRCUIT	CIRCUIT DIAGRAM
1	
2	
3	
4	
5	
6	
7	
8	

CIRCUIT	CIRCUIT DIAGRAM
A	
B	
C	
D	
E	
F	
G	
H	

CIRCUIT	CIRCUIT DIAGRAM
J	
K	
L	
M	
R	
S	

SYMBOL LEGEND	
SYM.	DEFINITION
	DESIGNATES TERMINALS AND CONTACTS
	DESIGNATES LAMP LOCATION
	DESIGNATES MAINTAINED CIRCUITS
	DESIGNATES OTHER POSITION
	DESIGNATES MOMENTARY CIRCUITS
	DESIGNATES TWO POSITION CONNECTION
	DESIGNATES EXTERNAL JUMPER PROVIDED BY CUSTOMER

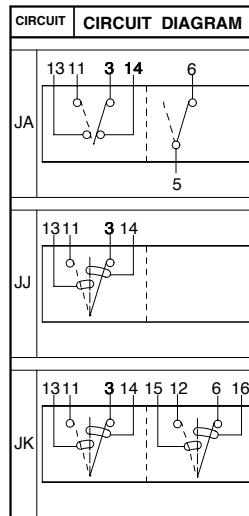
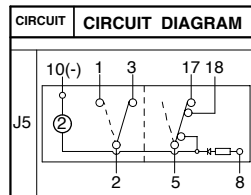
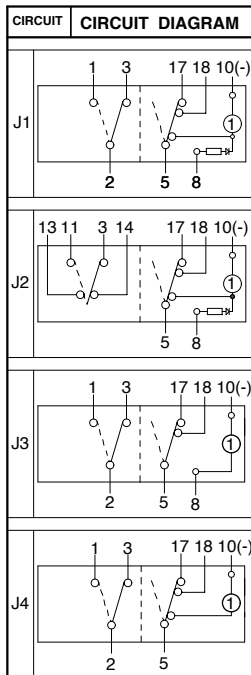
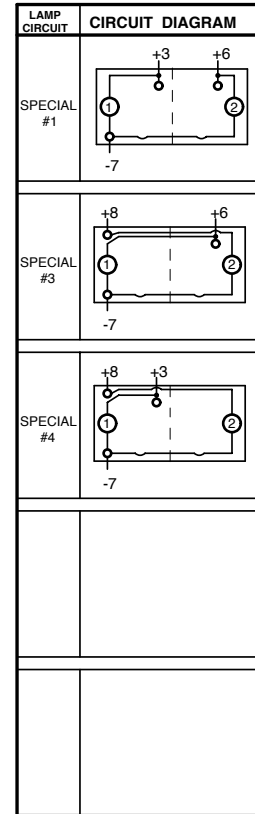
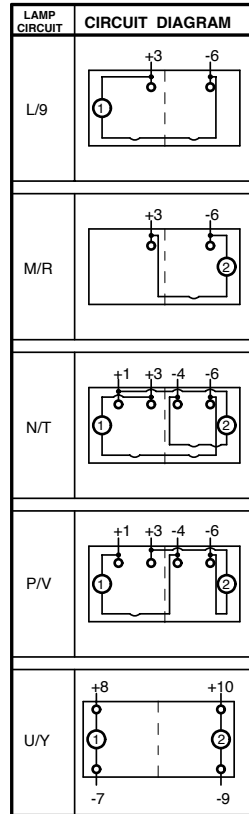
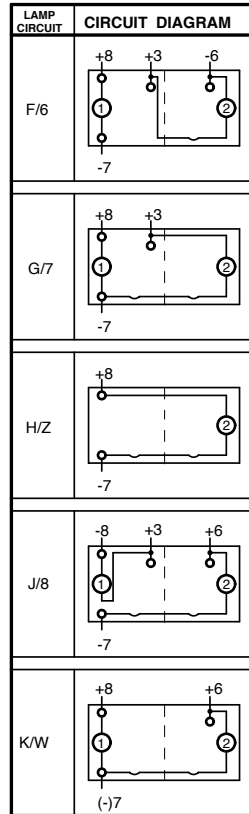
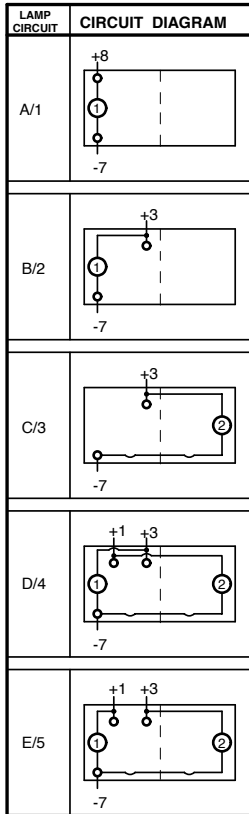

NOTE:
J circuits are available for all non-locking V-Series styles. Consult factory for p/n details.

SYMBOL LEGEND	
SYM.	DEFINITION
○	DESIGNATES TERMINALS AND CONTACTS
○	DESIGNATES LAMP LOCATION
○	DESIGNATES TWO POSITION CIRCUIT

CIRCUIT	CONNECTOR PART #
JA, JJ, JK	JC1-01
J1, J3, J4, J5	JC2-01
J2	JC3-01

V 1 D B B C 0 B - F A P C A B - 1 00

1 Series 2 Circuit 3 Rating 4 Termination Illumination 5 Lamp 6 Lamp 7 Lamp 8 Bracket 9 Actuator 10 Lens 11 Actuator Color 12 Legend 13 Legend Orientation 14 Actuator, Lens Legends

1 SERIES
V

2 CIRCUIT
Terminal Connections as viewed from bottom of switch:
8 terminal 10 terminal
1 - 7 8 - 7
1 - 4 1 - 4
2 - 5 2 - 5
3 - 6 3 - 6
10 - 9

() - momentary
SP - single pole - uses terminals 1, 2 & 3.
DP - double pole uses terminals 1, 2, 3, 4, 5 & 6.
Terminals 7, 8, 9 & 10 for lamp circuit only.

Position:	1	2	3
SP DP	2 & 3, 5 & 6	Connected Terminals	1 & 2, 4 & 5
1	A (ON)	NONE	OFF
2	B (ON)	NONE	OFF
3	C (ON)	NONE	(OFF)
4	D (ON)	NONE	ON
5	F (ON)	NONE	(ON)
6	J (ON)	OFF	ON
7	K (ON)	OFF	(ON)
8	L (ON)	OFF	(ON)

SPECIAL CIRCUITS

	2 & 3	2 & 3, 5 & 4	5 & 4
H*	2 & 3	2 & 3	OFF
G*	2 & 3, 5 & 6	2 & 3	OFF
M*	(2 & 3, 5 & 6)	2 & 3	OFF
R*	(2 & 3, 5 & 6)	2 & 3	2 & 1
E*	5 & 6	5 & 3	5 & 1
S*	2 & 3, 5 & 6	2 & 3	1 & 2

*Jumper between terminals 2 & 5 for circuits H, G, M, R & S are specified in selection 4. External jumper between terminals 2 & 4 for circuit E are provided by customer. Circuit E may be used for SP OFF-ON-ON circuit.

3 RATING³

1	.4VA @ 28VDC Resistive
B	15A 24V
C	20A 18V
D	20A 12V
E	20A 14V, 10A 14VT (circuit 1, 4, A & D only)
F	10A 14V, 6A 14VT (circuit G only)

4 TERMINATION / BASE STYLE

8 term	10 Term	Termination	Jumper
1	2	.250 TAB (QC) no barriers	No
A	B	.250 TAB (QC) with barriers	No
J	K	.250 TAB (QC) no barriers	Yes T2 to 5
3	4	Solder Lug no barriers	No
C	D	Solder Lug	No
5	F	Wire Leads no barriers	No
E	F	Wire Leads	No

Note: Codes J & K for circuits H, G & M.

5 ILLUMINATION
Lamp #1: above terminals 1 & 4 end of switch.; Lamp #2 above terminals 3 & 6 end of switch. Positive (+) and negative (-) symbols apply to LED lamps only

S	Lamps	Illumination Type	Lamp wired to Terminals
	NONE	-	-
A	1	INDEPENDENT	8 (+) 7 (-)
B	1	DOWN	3 (+) 7 (-)
C	2	UP	3 (+) 7 (-)
D	1	DOWN	3 (+) 7 (-)
	2	DOWN	1 (+) 7 (-)
E	1	UP	1 (+) 7 (-)
	2	UP	3 (+) 7 (-)
F	1	INDEPENDENT	8 (+) 7 (-)
	2	UP	3 (+) 6 (-)
G	1	INDEPENDENT	8 (+) 7 (-)
	2	UP	3 (+) 7 (-)
H	2	INDEPENDENT	8 (+) 7 (-)

SINGLE POLE SWITCHES ONLY

J	1	DOWN	3 (+) 8 (-)
	2	INDEPENDENT	6 (+) 7 (-)
K	1	INDEPENDENT	8 (+) 7 (-)
	2	INDEPENDENT	6 (+) 7 (-)

DOUBLE POLE SWITCHES ONLY

L	1	DOWN	3 (+) 6 (-)
	2	UP	3 (+) 6 (-)
N	1	DOWN	3 (+) 6 (-)
	2	DOWN	1 (+) 4 (-)
P	1	UP	1 (+) 4 (-)
	2	UP	3 (+) 6 (-)
U	1	INDEPENDENT	8 (+) 7 (-)
	2	INDEPENDENT	10 (+) 9 (-)

6 & 7 LAMP

No lamp	0	2 250VAC			
Neon	1	125VAC	5 6V	6 12V superbright	7 18V superbright
Incandescent LED*	4	3V		Green	Red
		Red	Amber		
2VDC	A	L	F	R	
6VDC	B	M	G	S	
12VDC	C	N	H	T	
24VDC	D	P	J	V	

* Consult factory for "daylight bright" LED options. Typical current draw for LED is 20ma.

8 BRACKET COLOR & PANEL SEAL

Color	No Gasket	1 Gasket	2 Gasket
Black	B	C	D
Gray	G	H	J
White	W	Y	Z

9 ACTUATOR STYLE

0	No Actuator - Furnished separately	
FA	Contura XIV	
FB	Contura XIV - Laser Etched	

10 LENS COLOR / STYLE

0 - No Actuator	Z - No Lens	Clear	White	Amber	Green	Red	Blue
1	6	B	C	G	H	M	T
2	7	C	H	N	U		
3	8	D	J	P	V		
4	9	E	K	R	W		
5	A	F	L	S	Y		PAD Printed
5	A	N/A	N/A	N/A	N/A		Laser-Etched

Lens color for LEDs must be clear, white, or match color of LED. Green or blue lenses are not recommended with Neon lamps.





11 ACTUATOR COLOR¹

O	N/A - No Actuator
C	Black
S	Red
Y	White

12 ACTUATOR LENS or BODY LEGEND²

00	No Legend this location/No actuator	
11	ON	12 OFF
	OFF	ON
13	I	O
14	O	I
15	O O	16 O O
	F N	N F
	F	F

13 LEGEND ORIENTATION

0	No legend	
1	Orientation 1	
2	Orientation 2	
3	Orientation 3	
4	Orientation 4	

14 ACTUATOR / LENS LEGEND

00 No legend this location / no actuator
(used with codes 11-18 in selection 12) Selection 14 required when switch requires two legends. If the two legends consist of one lens and one body legend, lens legend must be specified in selection 12; body legend specified in selection 14.
For legend options & codes, visit us at www.carlingtech.com.

Notes:
Consult factory to verify horsepower rating for your particular circuit choice.
1 Custom colors are available. Consult factory.
2 White imprinting is standard on black actuators; Black imprinting is standard on white, red and gray actuators.
3 Additional ratings available. See V-Series Switch Accessories page.

Reduce inventory levels and cost by stocking actuators and base switches separately.

Contura II, III, IV, V, VI, VII, X, XI, XII, XIV Base switches separately: specify **V** with code selections 2-8 in the ordering schemes.

Contura II, III, IV, V Actuator only: VV with code **A** or **C** for selection 9, & with selections 10-14 in the ordering schemes.

Contura VI Actuator with lenses and inserts only: VV with code selections 9-16

Contura II, III, IV, V, VII Actuator only: VV with code **A, C, E, G, P** or **Z** for selection 9 & with selections 10-14 in the ordering schemes.

Contura X, XI, XII, XIV actuators with lenses separately: VV with code selections 9-14 in the ordering schemes.

Panel Seal: VPS

Contura X & XI actuators without lenses separately:

VVR	6	1	00	1
1 Actuator Separately	2 Actuator Style/Color	3 Lens Opening	4 Actuator Legend	5 Legend Orientation

1 CONTURA X & XI ACTUATOR SEPARATELY
VVP

2 ACTUATOR STYLE & COLOR

	Black	Gray	White	Red
Contura X	1	2	3	4
Contura XI	6	7	8	9

3 LENS OPENING FOR¹

1 One bar lens	5 square lens on top/ bar lens on bottom (Contura X only)
2 One bar lenses	
3 One square lens	
4 two square lens	

4 ACTUATOR LENS OR BODY LEGEND

00 - No Legend this location

11 ON	12 OFF	13 I	14 O
OFF	ON	O	I
15 O O	16 O O	17 O I	18 I O
F N	N F		
F	F		

For additional legend options & codes, visit us at www.carlingtech.com.

5 LEGEND ORIENTATION¹

0 No legend
1 Orientation 1
2 Orientation 2
3 Orientation 3
4 Orientation 4

Contura X, XI & XII top piece of 2-piece lens separately:

VVT	1	1 TOP OF LENS SEPARATELY VVT
1 Lens Separately	2 Color	
		2 COLOR 1 Clear 2 Smoke 3 White

Contura X, XI & XII actuator lens assembly:



1 piece lens/bar lens are positioned the same as bottom lens for assembly, minus the top lens. Lenses snap in from bottom.

- Notes:
- If actuator lens opening for 2 bar or 2 square lenses, legend orientation 0,1, or 2 must be chosen.
 - Center of actuator marking not available for Contura XII.
 - Legend is not available for bar style lens.
 - Not recommended with neon lamps.
 - Must also order top piece of 2 piece square lens separately.

Contura XII actuators without lenses separately:

VVP	J	1	Z	21	1	00
1 Actuator	2 Style & Color	3 Lens Opening	4 Lens Opening	5 Legend	6 Legend Orientation	7 Legend Orientation

1 CONTURA XII ACTUATOR SEPARATELY
VVP

2 ACTUATOR STYLE & COLOR

J Black	K Gray	N White	M Red
---------	--------	---------	-------

3,4 LENS OPENING FOR

Z No lens	1 Bar lens	2 Square lens
-----------	------------	---------------

5, 7 LENS OR BODY LEGEND²

00 - No Legend	21	22	23	24
	OFF	ON	O	I
	25 O	26 O	27 O	28 I
	F	N		
	F			

For additional legend options & codes, visit us at www.carlingtech.com.

6 LEGEND ORIENTATION³

0 No legend
1 Orientation 1
2 Orientation 2

Contura X, XI & XII actuator lens assembly separately:

VVL	2	1	00	0
1 Lens Separately	2 Lens Style	3 Lens Color	4 Legend	5 Legend Orientation

1 CONTURA X, XI & XII LENS SEPARATELY
VVL

2 LENS STYLE³

1 Bar lens	2 One Piece Square lens	3 Bottom of Two-Piece Square lens ⁵
------------	-------------------------	--

3 TRANSLUCENT LENS COLOR

1 Clear	2 White	3 Amber	4 Green ⁴	5 Red	6 Blue ⁴
---------	---------	---------	----------------------	-------	---------------------

4 LENS OR BODY LEGEND²

00 - No Legend	21	22	23	24
	OFF	ON	O	I
	25 O	26 O	27 O	28 I
	F	N		
	F			

For additional legend options & codes, visit us at www.carlingtech.com.

5 LEGEND ORIENTATION³

0 No legend
1 Orientation 1
2 Orientation 2
3 Orientation 3
4 Orientation 4

Easily integrate Contura products into your system, with Contura Accessories

Contura Connectors

Q.C. SELECTION GUIDE					
COMPANY SERIES	PART NO		WIRE RANGE		ORIENTATION
	PLAIN BRASS	TIN PLATED BRASS	AWG	MM ² (REF)	
PACKARD 58 SERIES	02965580		12	3.0	B
	02965471	12010601	(2)16-14	(2)1.0-2.0	
	02965470		16-14	1.0-2.0	
	02965469	06288318	20-18	.5-.8	
PACKARD METRI-PACK 630 SERIES		12084590	10	5.0	A
		12052224	12	3.0	
		12015870	16-14	1.0-2.0	
		12020035	(2)22-18	(2).5-.8	
	12015832	12015869	20-18	.5-.8	
		12052222	20-22	.35-.5	
AMP 250 SERIES FASTIN-FASTON	60253-1	60253-2	16-12	1.3-3	B
	42100-1	42100-2	(2) 16	(2) 1.3	
	60295-1	60295-2	18-14	.8-2	
			22-18	.3-9	

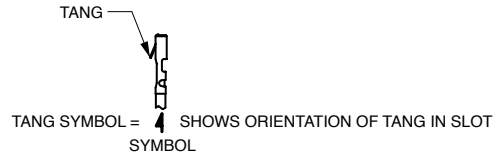
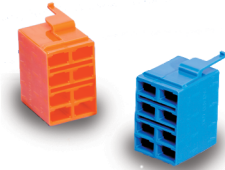

NOTE: Consult Delphi Packard and/or Amp on actual part numbers and availability. AMP is a registered trademark of AMP Inc. Harrisburg, PA. Delphi Packard is a registered trademark of Delphi-Packard Electrical Systems Warren, Ohio

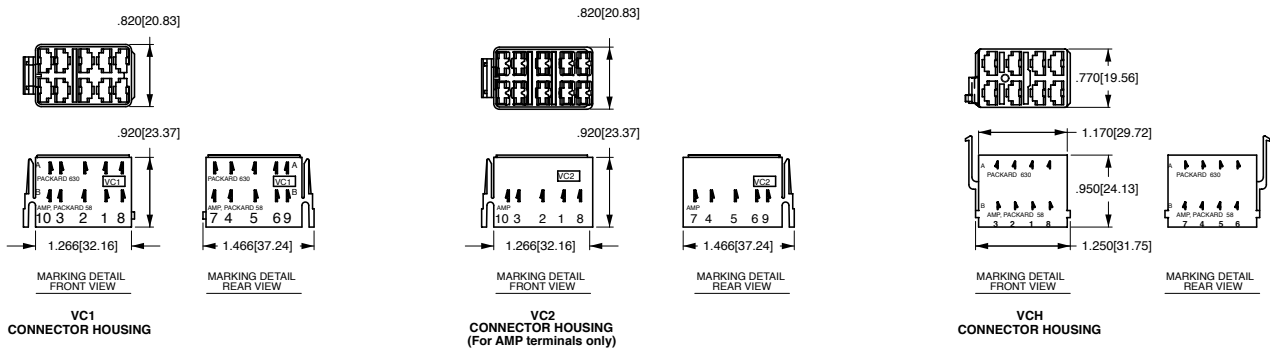

Contura X Boot (P/N VB1-01)

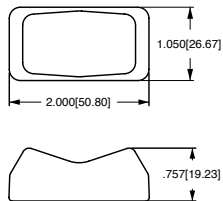

Additional V-Series Ratings

- 1 .4VA @ 28VDC Resistive
- 4 10A 250VAC 1/2 HP, 15A 125 VAC 1/2 HP, No Agency Listings
- B 15A 24V
- C 20A 18V
- D 20A 12V
- E 20A 14V, 10A 14VT (circuits 1, 4, A, & D only)
- F 10A 14V, 6A, 14VT (circuit G only)
- G 20A 6V
- H 20A 3V

Contura II, III, IV & V Actuator Removal Tool (P/N VRT)

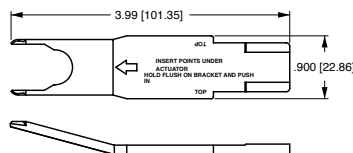

Contura Mounting Panels

Dimensional Specifications: in. [mm]

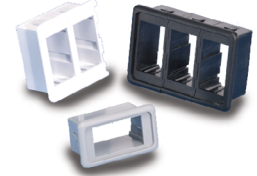

MOUNTING PANEL
For additional units, add 1.03[26.2] per unit.
For more than 2 V-Series Switches, add
middle section. Available in Panel Thicknesses
listed below. Consult factory.

MOUNTING PANEL THICKNESS	
.062[1.57]	.187[4.75]
.093[2.36]	.250[6.35]
.125[3.17]	.375[9.52]

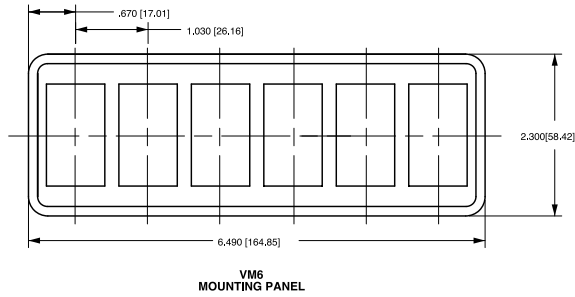
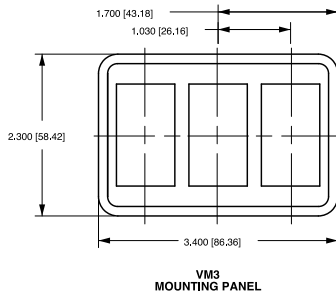
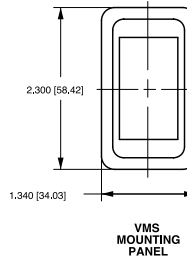
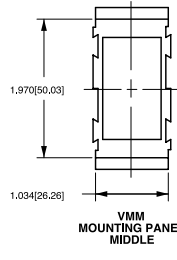
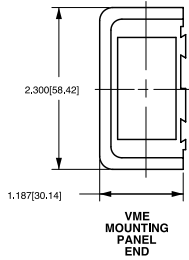
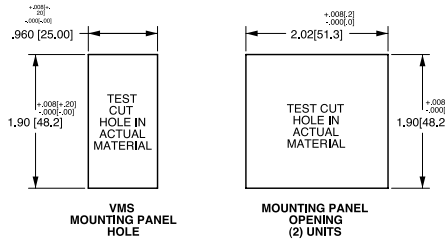

Contura Hole Plug

Dimensional Specifications: in. [mm]

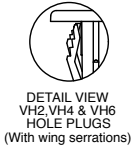
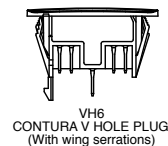
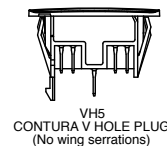
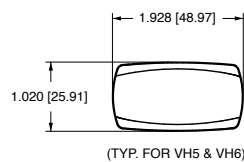
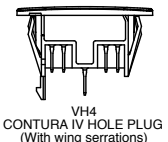
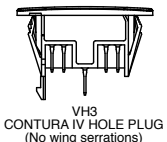
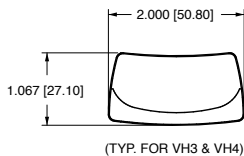
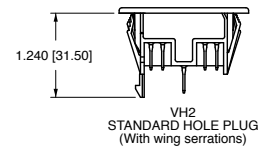
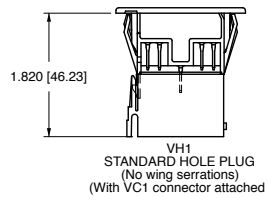
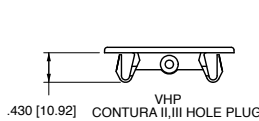
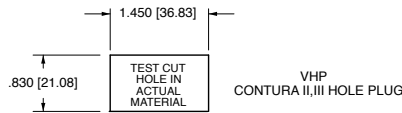

Authorized North America Sales Representatives

Carling extensive sales representative network group is strategically located and ready to answer any questions. Find your local representative by clicking on a group name on the map below or by visiting www.carlingtech.com/findarep.



About Carling

Founded in 1920, Carling Technologies is a leading manufacturer of electrical and electronic switches and assemblies, circuit breakers, electronic controls, power distribution units, and multiplexed power distribution systems. With four ISO registered manufacturing facilities and technical sales offices worldwide, Carling Technologies Sales, Service and Engineering teams do much more than manufacture electrical components, they engineer powerful solutions! To learn more about Carling please visit www.carlingtech.com/company-profile.

Worldwide Headquarters

Carling Technologies, Inc.
60 Johnson Avenue • Plainville, CT 06062
Phone: (860) 793-9281 • Fax: (860) 793-9231
Email: sales@carlingtech.com • www.carlingtech.com

East Region Sales Office, CT • ersm@carlingtech.com
Midwest Region Sales Office, IL • mrsm@carlingtech.com
West Region Sales Office, CA • wrsm@carlingtech.com

Asia-Pacific Headquarters

Carling Technologies, Asia-Pacific Ltd.,
Kowloon, Hong Kong
Int + 852-2737-2277 • Fax: Int + 852-2736-9332
Email: sales@carlingtech.com.hk

Shenzhen, China • shenzhen@carlingtech.com
Shanghai, China • shanghai@carlingtech.com
Pune, India • india@carlingtech.com
Kaohsiung, Taiwan • taiwan@carlingtech.com
Yokohama, Japan • japan@carlingtech.com

Europe / Middle East / Africa Headquarters

Carling Technologies LTD
4 Airport Business Park, Exeter Airport,
Clyst Honiton, Exeter, Devon, EX5 2UL, UK
Int + 44 1392-364422 • Fax: Int + 44 1392-364477
Email: ltd.sales@carlingtech.com

GmbH, Germany • gmbH@carlingtech.com
SAS, France • sas@carlingtech.com

REV_SW_V_06_2014



Carling Technologies™

Innovative Designs. Powerful Solutions.

Компания «Life Electronics» занимается поставками электронных компонентов импортного и отечественного производства от производителей и со складов крупных дистрибьюторов Европы, Америки и Азии.

С конца 2013 года компания активно расширяет линейку поставок компонентов по направлению коаксиальный кабель, кварцевые генераторы и конденсаторы (керамические, пленочные, электролитические), за счёт заключения дистрибьюторских договоров

Мы предлагаем:

- Конкурентоспособные цены и скидки постоянным клиентам.
- Специальные условия для постоянных клиентов.
- Подбор аналогов.
- Поставку компонентов в любых объемах, удовлетворяющих вашим потребностям.
- Приемлемые сроки поставки, возможна ускоренная поставка.
- Доставку товара в любую точку России и стран СНГ.
- Комплексную поставку.
- Работу по проектам и поставку образцов.
- Формирование склада под заказчика.
- Сертификаты соответствия на поставляемую продукцию (по желанию клиента).
- Тестирование поставляемой продукции.
- Поставку компонентов, требующих военную и космическую приемку.
- Входной контроль качества.
- Наличие сертификата ISO.

В составе нашей компании организован Конструкторский отдел, призванный помогать разработчикам, и инженерам.

Конструкторский отдел помогает осуществить:

- Регистрацию проекта у производителя компонентов.
- Техническую поддержку проекта.
- Защиту от снятия компонента с производства.
- Оценку стоимости проекта по компонентам.
- Изготовление тестовой платы монтаж и пусконаладочные работы.



Тел: +7 (812) 336 43 04 (многоканальный)
Email: org@lifeelectronics.ru